



### Request for Vendor Contract Update

Pursuant to the terms of your awarded vendor contract, all vendors must notify and receive approval from Region 4/OMNIA Partners, Public Sector when there is an update in the contract. No request will be officially approved without the prior authorization of Region 4. Region 4 reserves the right to accept or reject any request.

Enwork (Vendor Name) hereby provides notice of the following update to

Contract number: R240103 for OMNIA on this date 09/26/25  
Contract Title

**Instructions:** Vendors must check all that may apply and shall provide supporting documentation. Place your initials next to each item to confirm that documents are indeed included. Request received without supporting documentation will be returned.

**Authorized Distributors/Dealers**  
\_\_\_\_ Addition  
\_\_\_\_ Deletion  
\_\_\_\_ Supporting Documentation

**Price Update**  
 Supporting Documentation

**Products/Services**  
 New Addition  
 Update Only  
 Supporting Documentation

**Material Change**  
\_\_\_\_ Assignment  
\_\_\_\_ Change in ownership (sale/purchase)  
\_\_\_\_ Bankruptcy  
\_\_\_\_ Acquisition  
\_\_\_\_ Merger  
\_\_\_\_ Supporting Documentation

**Discontinued Products/Services**  
\_\_\_\_ Supporting Documentation

**States/Territories**  
\_\_\_\_ Supporting Documentation

**Other** \_\_\_\_\_  
\_\_\_\_ Supporting Documentation

Notes: Vendor may include other notes regarding the contract update here: (attach another page if necessary). For material changes, indicate the name of the company of the awarded supplier and the official name of assigned or added company.

On November 1<sup>st</sup>, 2025 Enwork is moving to our V.21 price list. This V.21 price increase includes new collections such as Camber, Luna Credenzas, Terra Planters, Accessory lights and Affinity Reception. All of these new products and other product family additions are incorporated in this V.21 price list. New products highlighted on the following pages.

Signature of Vendor: George Kudwa

**Approved Date** 10/4/2025 | 9:50 AM CDT

Submitted By: George Kudwa

**Denied Date** \_\_\_\_\_

Title: Sales Manager

Region 4 ESC 1<sup>st</sup> Review: CW  
Initials

Contact Phone Number: 616 600-3093

Email Address: gkudwa@enwork.com

Region 4 ESC:

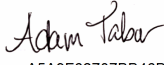
Signed by:  
  
A5A9F62707BB46D...  
Signature

**For material changes, the awarded contract holder and/or subsequent assignee agrees to and understands the following principles:**

i. **Contract holder reference.** If the contract holder undergoes a merger, acquisition, or partial assignment, in which case they still maintain the contract, then all transactions made under the existing contract number (including purchase orders) must reference the name of the awarded contract holder. The exception to this requirement is if the contract holder no longer holds the contract or if the company has been acquired by another company and undergone a name change. Notice of the authorized name change, to the existing contract, must be provided and approved by Region 4.

In instances where the contract holder has acquired a separate and distinct company, and it is necessary to designate those certain purchases facilitated by the non-contract holder, then this designation may be made if, and only if, the contract holder is also referenced on the transaction.

ii. **Maintenance of records.** Both the awarded contract holder and subsequent assignee agree to remain responsible for maintaining all auditable records, including documents kept in the ordinary course of business and sales invoices, related to OMNIA Partners, Public Sector and/or contract number pursuant to the statutory requirements identified in the vendor contract.

iii. **Payments.** Both the awarded contract holder and subsequent assignee agree that all payments made by participating entities must be made directly to the contract holder, unless otherwise approved by Region 4. Accordingly, both parties acknowledge that in instances where it is necessary to designate the purchases facilitated by assignee, that the contract holder must also be referenced on the purchase order.

iv. **Handling of Proprietary and/or Confidential Information.** In accord with the terms of the contract, both awarded vendor and assignee agree that at all times it will hold in strict confidence and not disclose to any third party Confidential and/or Proprietary information of Region 4, except as approved in writing by Region 4, and will use the Confidential Information for no purpose other than providing services under the contract. Both awarded vendor and assignee shall only permit access to Confidential Information to those of its employees or authorized representatives having a need to know and who have signed confidentiality agreements or are otherwise bound by confidentiality obligations at least as restrictive as those contained herein.

This document is to be construed in strict accordance with the terms and conditions outlined in the Region 4/vendor Master Agreement referenced herein. Both awarded vendor and assignee agree to uphold the vendor obligations set forth in the vendor agreement. This Agreement will become effective when signed by all parties.



ENWORK

# Luna Credenza

Luna is designed to be as inviting as it is functional. Its gently curved corners create a soft, approachable aesthetic for any space. Make a bold statement with your storage by choosing from a variety of materials.

[enwork.com](https://enwork.com)

## Details

- Credenza available in 48", 60", and 72" widths.
- Available in laminate, veneer, and white oak tambour.
- Credenza has 10" radius, designed to coordinate with tops with 10" radius corners.
- Depth is 20" and height is 31".
- Available with Push Latch or Sleek pulls.
- Tambour credenzas come with rift cut white oak veneer tops and back panels stained to match the tambour.
- Credenza sits on a 1- $\frac{1}{8}$ " thick recessed plinth.
- Pull-out waste receptacle available with either one centered accent light or no accent lights only.
- Credenza is non-locking.

## Credenza Sizes

Luna is available in 48", 60", and 72" widths. 48"W credenzas have two doors, while 60" and 72" credenzas have four doors.



48"



60"



72"



Tambour, veneer, and laminate finishes

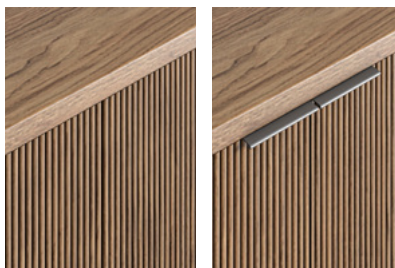

Push Latch or Sleek pulls



Integrated Accent Lights  
(available with 2 optional USB-A ports)

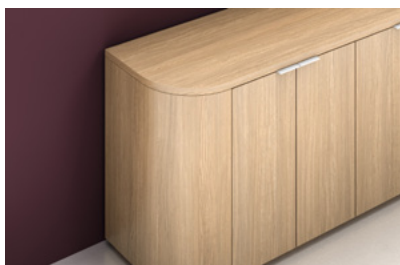

10" radius corners to pair with 10" radius conference tops

### Accent Light Placement

One Light Centered (shown on 60"W credenza)

Available for 48", 60", and 72" credenzas

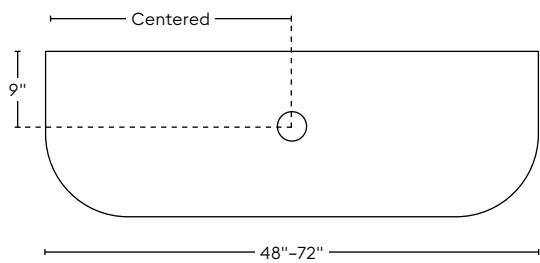
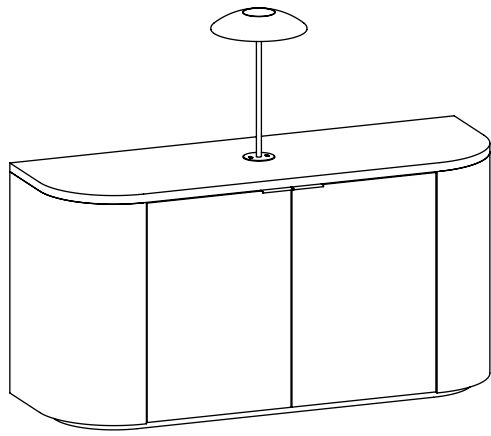

Two Lights (shown on 72"W credenza)

Available for 60" and 72" credenzas only

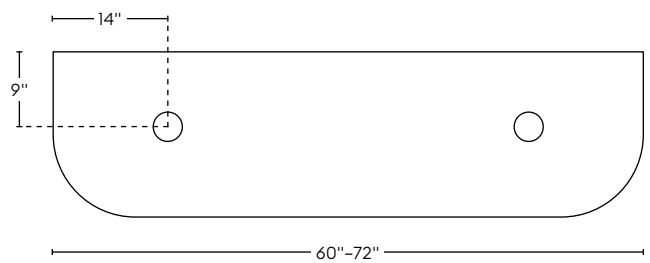
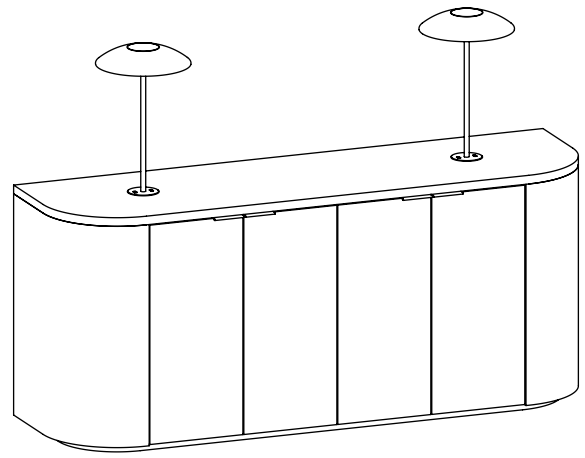



Specifications are subject to  
change without prior notice.

Revised 08.25  
[enwork.com](http://enwork.com)

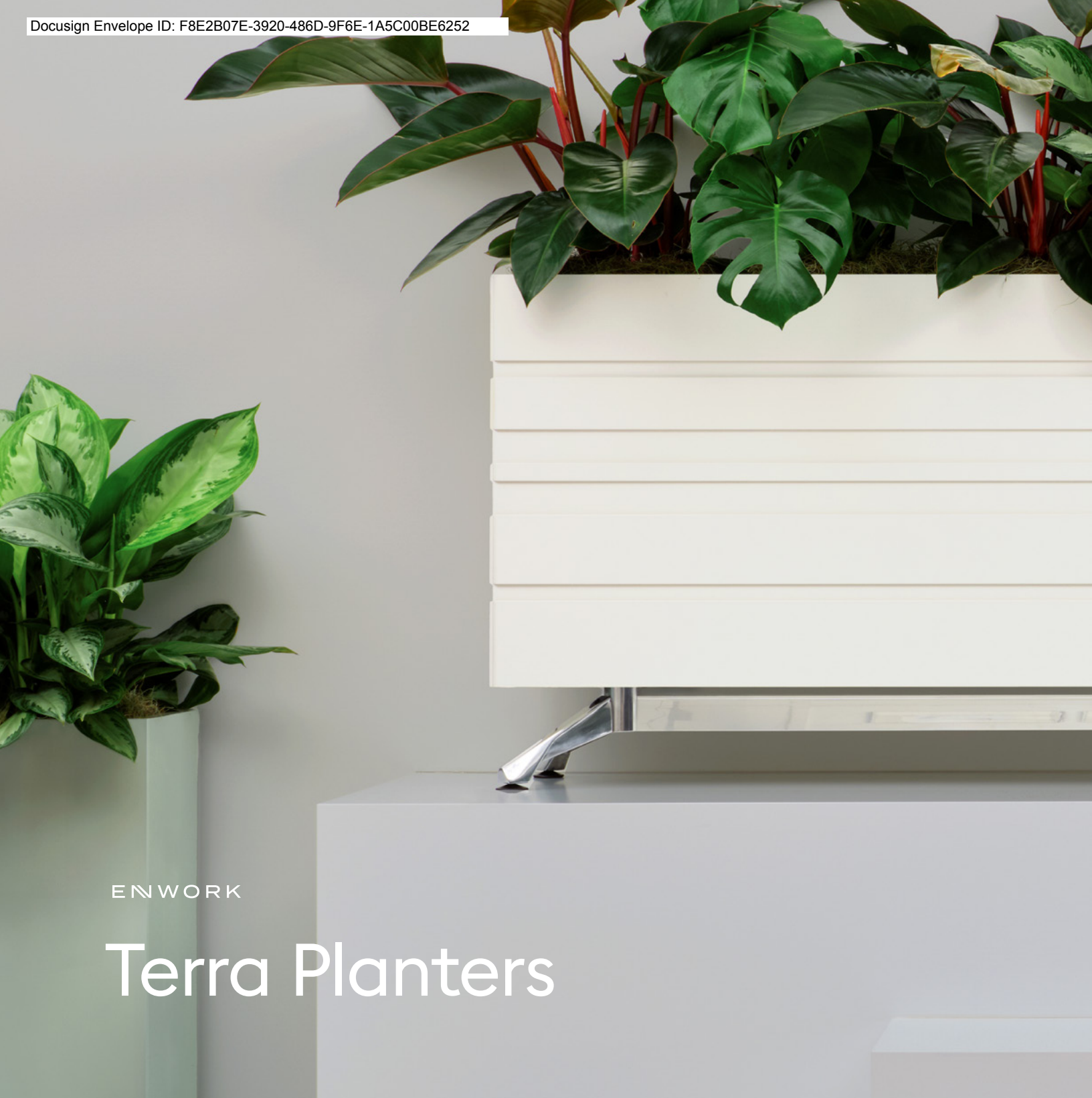

ENWORK

# Terra Planters

Promoting wellness through biophilic design, Terra Planters incorporate intentional visual elements and function as a versatile partition. Planters are available in three finishes, and a variety of sizes, perfect for defining spaces.

[enwork.com](https://enwork.com)

## Details

- Depth is 18" and overall height is 34" regardless of base option.
- Finish options include laminate, veneer, painted MDF with horizontal accents, and solid wood tambour.
- Standard paint options available for bases.
- Material for horizontal accent planters is painted MDF.
- Tambour planters top surface and 2" of visible inner sides are veneer.
- Laminate grain direction is horizontal. Veneer grain direction is vertical.
- Top surface with holes for plants is recessed 2". Plant pots sit on a recessed inner shelf below the top an additional 10".
- Holes for plants are 10" diameter.
- If using real plants, make sure to utilize appropriate drip trays to prevent damage to the planter. Water damage to the planter will not be covered under warranty. Plants and drip trays not included.

## Base Options

Terra Planters are available as standard with no base, Zori® legs, or Ligouri legs.



No Base



Zori®



Ligouri

## Finish Options



Horizontal Accent  
(painted MDF)

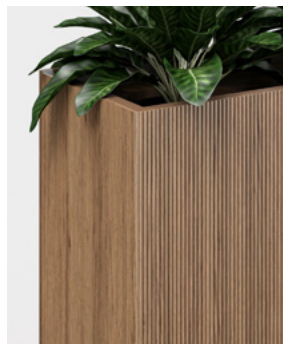

White Oak Tambour

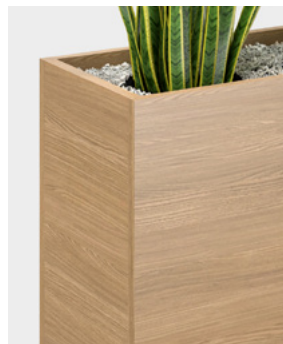

Laminate  
(horizontal grain direction)

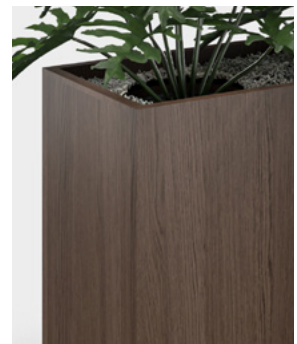

Veneer  
(vertical grain direction)

### Multi-Unit Application

Terra is designed to be used in conjunction with multiple units to define spaces. If multiple units of various widths are intended to be placed flush side-by-side in a row or a 90-degree angle, spacing between plant pots is 18" for all widths (36", 54", and 72").



#### Dimensions

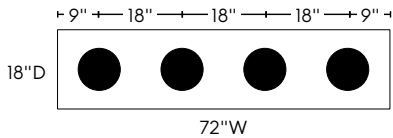
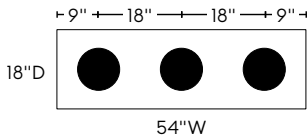
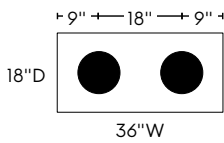

#### Side-by-Side Example

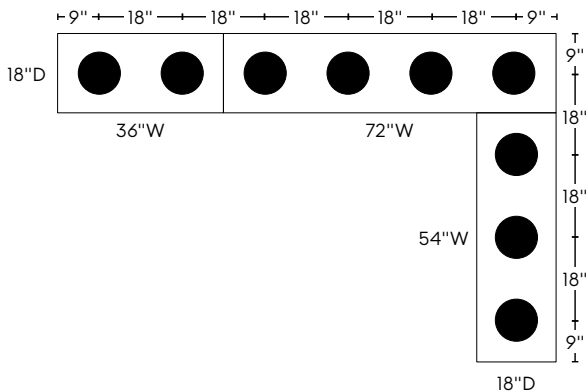

### Standalone Application

If Terra is intended to be used standalone, spacing between plant pots on a single unit varies based on width. For example, a 48"W Terra planter is 16" between pots, but for a 54"W Terra planter, it's 18" between pots. Widths available for standalone planters include 48", 54", 60", and 66".



#### Dimensions

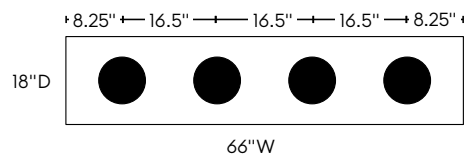
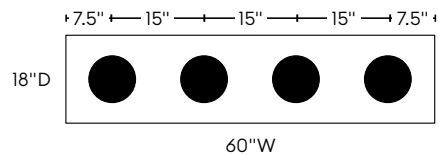
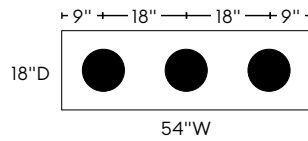
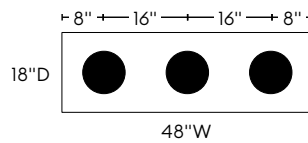



ENWORK

Specifications are subject to  
change without prior notice.

Revised 08.25  
[enwork.com](http://enwork.com)



ENWORK

# Accent Light

Accent lights define spaces and create a pleasant work environment. With dimmable capabilities, the lighting can easily adapt to any setting, creating a personalized and comfortable atmosphere.

## Product Details

- Available in Enwork standard paints.
- Custom paints can be accommodated as a special.
- Options to include 2 USB-A ports.
- Light is 19"H and 12"W overall.
- Auto shut off after 10 hours.
- Dimmable from 100% to 10%.
- Color temperature is 2700k.
- 11' power cord included.
- For use with standard 1-1/8" thick laminate and veneer tops.
- Light is touch-operated. Brightness is adjusted by holding.

## Surface Mounted

Requires field cut or grommet hole. Contact [designteam@enwork.com](mailto:designteam@enwork.com) to quote custom grommet holes or locations.



## Available Products

Accent Lights are standard accessories for Landing Team Tables, Alkalign Conference Tables, and Luna Credenzas.



## Optional USB Integration

Accent Lights are available with 2 USB-A charging ports.





Specifications are subject to  
change without prior notice.

Revised 08.25  
[enwork.com](http://enwork.com)

ENWORK

# Affinity™ Reception

A design that welcomes and inspires, Affinity Reception features a refined, simplified aesthetic with standout details such as a waterfall quartz transaction surface that is designed to uplift any space. Optional painted or polished aluminum trim enhances first impressions.

## Details

- Transaction worksurfaces are 12"D and available in flat or 90-degree overlay configurations.
- Finishes for the transaction worksurface are laminate, solid surface, or quartz.
- Transaction width is 24" shorter than wall width (inset 12" from each end).
- Wall height is 42".
- Storage sold separately. Utilize Affinity Value storage for use under worksurfaces.
- Main worksurface is 30"D. Return worksurfaces are 24"D. Continuous worksurface is 29"H.
- Optional trim height is 29"H to align with worksurface.

---

## Configurations

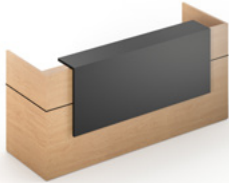

Rectangle Reception Desk



L-Shaped Reception Desk  
(Right Hand Shown)

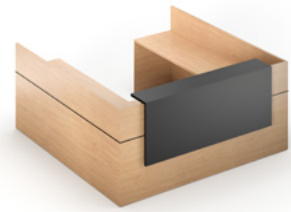

U-Shaped Reception Desk

---

## Storage

Affinity Reception is designed for use with Affinity Value Storage to bring modularity and customization to reception spaces.



Lateral/Lateral File

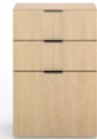

Box/Box/File Pedestal



Double-Door Cabinet

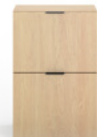

File/File Pedestal



Bookcase

### Transaction Surface

Available in Standard (flat) or 90-degree Overlay configurations. Finish options for Transaction Surfaces include laminate, solid surface, or quartz.

Transaction surfaces are 12"D and are inset 12" from both reception edges.



Standard Transaction

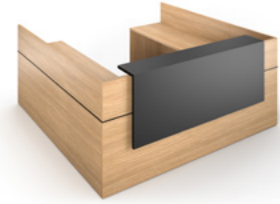

90-degree Overlay Transaction

---

### Optional Aluminum Trim

Available with and without aluminum trim detail. Finish options include polished or painted.

Optional trim height is 29"H to align with worksurface.

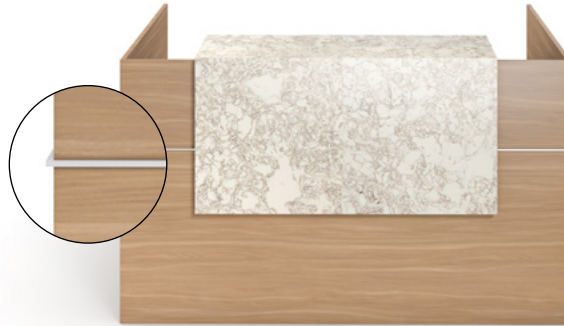

---

### Cable Management

Main worksurface includes two grommet cutouts located in each corner for efficient cable management.



### Rectangle Reception Desk

Worksurface height is 29"H

Width 1	72-96"
Depth 1	30"
Height	42"

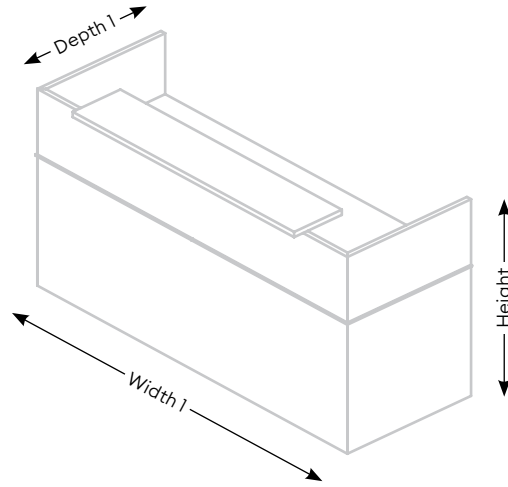

### L-Shaped Reception Desk

Worksurface height is 29"H

Width 1	72-96"
Width 2	72-96"
Depth 1	30"
Depth 2	24"
Height	42"

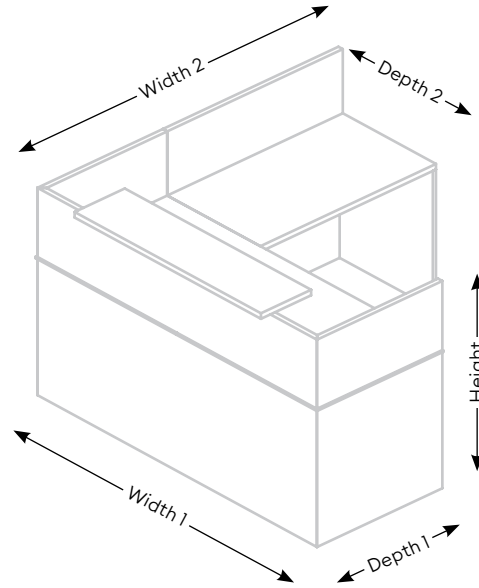

### U-Shaped Reception Desk

Worksurface height is 29"H

Width 1	84-96"
Width 2	84-96"
Depth 2	24"
Height	42"

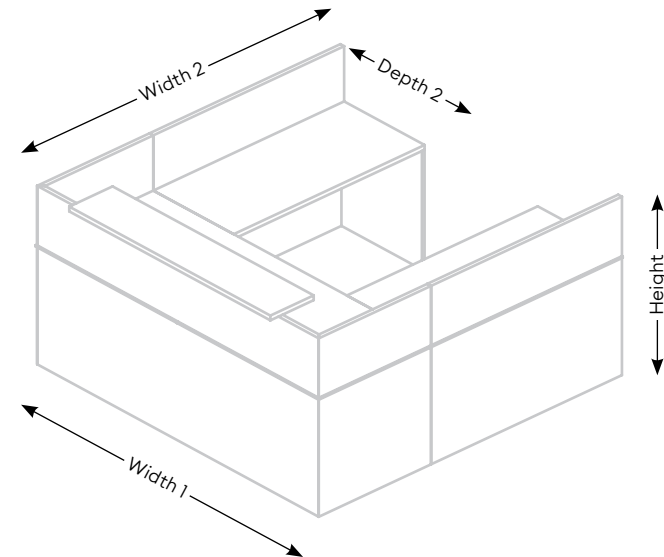



Specifications are subject to  
change without prior notice.

Revised 07.25  
[enwork.com](http://enwork.com)

Adam Tabor  
Director, Procurement  
Region 4 Education Service Center  
7145 West Tidwell Road  
Houston, TX 77092

RE: ASSA Group dba Enwork V.21 Price Increase (R240103)

Dear Mr. Tabor,

On November 1<sup>st</sup>, 2025, Enwork will be implementing our V.21 price list. This price increase includes new finishes, products and product extensions. We are also removing discontinued/obsolete products.

A small price increase of approximately 3% is included with this update. This price adjustment directly ties with the cost increases faced by Enwork since launching our V.20 price list last November. PPI reports found on the following pages.

- Metals and Metal Products: Iron and Steel
- Office Furniture (Including Fixtures) Manufacturing
- Office Furniture, Except Wood, Manufacturing

Enwork is formally requesting a price increase with OMINA to our commercial V.21 price list on 11/01/2025.

If you have any questions or concerns, please do not hesitate to contact me directly.

Sincerely,



George Kudwa  
Inside Sales Manager  
[gkudwa@enwork.com](mailto:gkudwa@enwork.com)

