



## REQUEST FOR VENDOR CONTRACT UPDATE

Pursuant to the terms of your awarded vendor contract, all vendors must notify and receive approval from NCPA when there is an update to the contract. No request will be officially approved without the prior written authorization from NCPA. NCPA reserves the right to accept or reject any request.

\_\_\_\_HOLMRIS US INC.\_\_\_\_\_(Vendor Name) hereby provides notice of the following update to NCPA contract number: \_\_\_\_07-71\_\_\_\_ on this date \_\_\_\_11.9.2023\_\_\_\_.

### Instructions:

**Vendors must check all that may apply and provide supporting documentation.** Be sure to sign the signature page with all required signatures, prior to submitting your update for approval.

*This form is not intended for use if there is a change in operations, which may adversely affect members, i.e. assignment, bankruptcy, change of ownership, merger, etc.*

### Authorized Affiliates/Dealers/Distributors/Resellers

- Additions
- Deletions

### Products/Services (check all that apply)

- Additions
- Deletions
- Modifications
- Pricing Update

**Other** Vendor may include other notes regarding the contract update here: (attach another page if necessary).

Pricing update to reflect general market increases on materials, labor and shipping. Average pricing increase range of 3%-12%

NEW Price lists covered under this contract update:

SILEN USD LIST 2022.9  
Chatbox by Silen USD LIST 2022.9

\_\_\_\_\_  
Vendor Name

\_\_\_\_\_  
Submitted By

  
Signature

\_\_\_\_\_  
Date

11.9.2023

-----  
**FOR USE BY NCPA ONLY:**

Sarah Vavra, SVP Public Sector Contracting

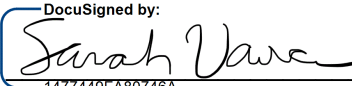
DocuSigned by:  
  
Signature

\_\_\_\_\_  
Date

11/13/2023 | 10:31 AM CST

# CHATBOX BY SILEN



LIST USD || ISSUED SEPTEMBER 2022  
CHATBOXBYSILEN.COM

**HOLMRIS**

Holmrís US Inc is the sole distributor of Chatbox by Silen products in the United States.

## CHATBOX || FINISHES

### EXTERIOR WALL



WHITE  
RAL 9003

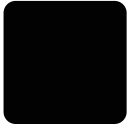

BLACK  
RAL 9011

### INTERIOR COLOR



DARK GRAY  
1897

### DOOR FRAME/TRIM

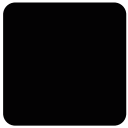

BLACK  
RAL 9011

# CHATBOX || FREIGHT

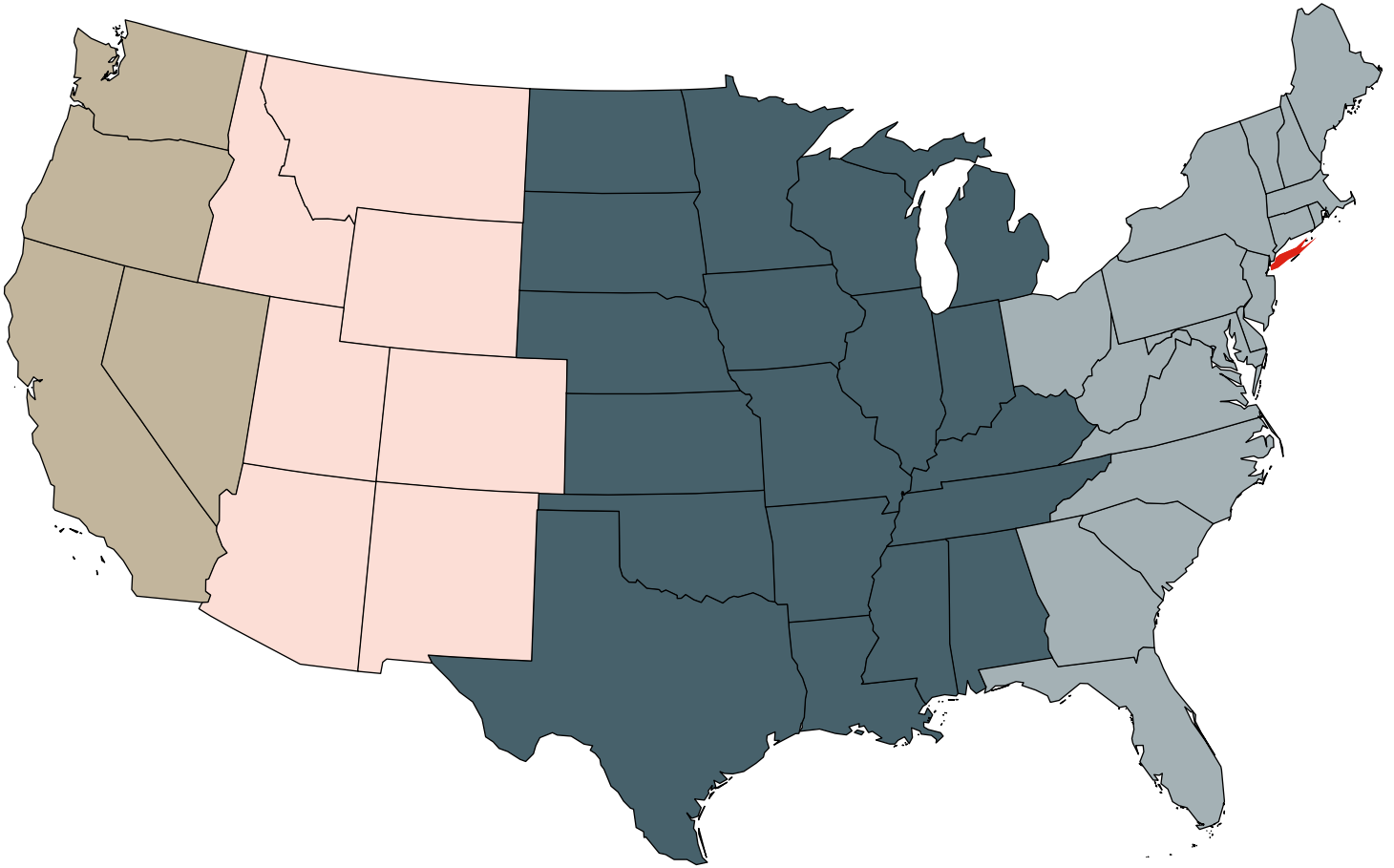

ZONE 1 - EAST COAST
  ZONE 2 - CENTRAL
  ZONE 3 - MOUNTAIN
  ZONE 4 - WEST COAST
  NYC - CALL FOR QUOTE

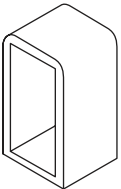

SINGLE

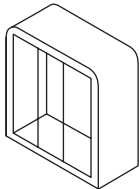

DUO

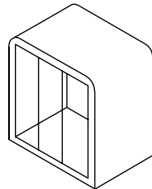

QUATTRO

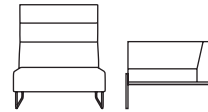

DUO FURNITURE PACKAGE

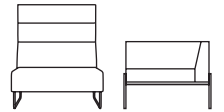

QUATTRO FURNITURE PACKAGE

	\$950	\$1,150	\$2,300	\$800	\$1,600
	\$1,100	\$1,250	\$2,600	\$1,000	\$2,000
	\$1,300	\$1,450	\$2,900	\$1,200	\$2,400
	\$1500	\$1,650	\$3,300	\$1,400	\$2,800

PRICE PER UNIT

PRICE PER UNIT

PRICE PER UNIT

PRICE PER UNIT

PRICE PER UNIT

CHATBOX SINGLE

# Every office deserves a Chatbox

For deep work, private calls, or a creative session.

**EXTERIOR (W X H X D):** 39.4" x 87.4" x 39.4" in

**INTERIOR (W X H X D):** 34.2" x 80.3" x 38.6" in

**NETWEIGHT:** 727.5 lb

**PRODUCT PACKED ON A PALLET:** 90.6" x 47.2" x H 25.6"

**TOTAL WEIGHT** 794 lb



# CHATBOX SINGLE || SPECS

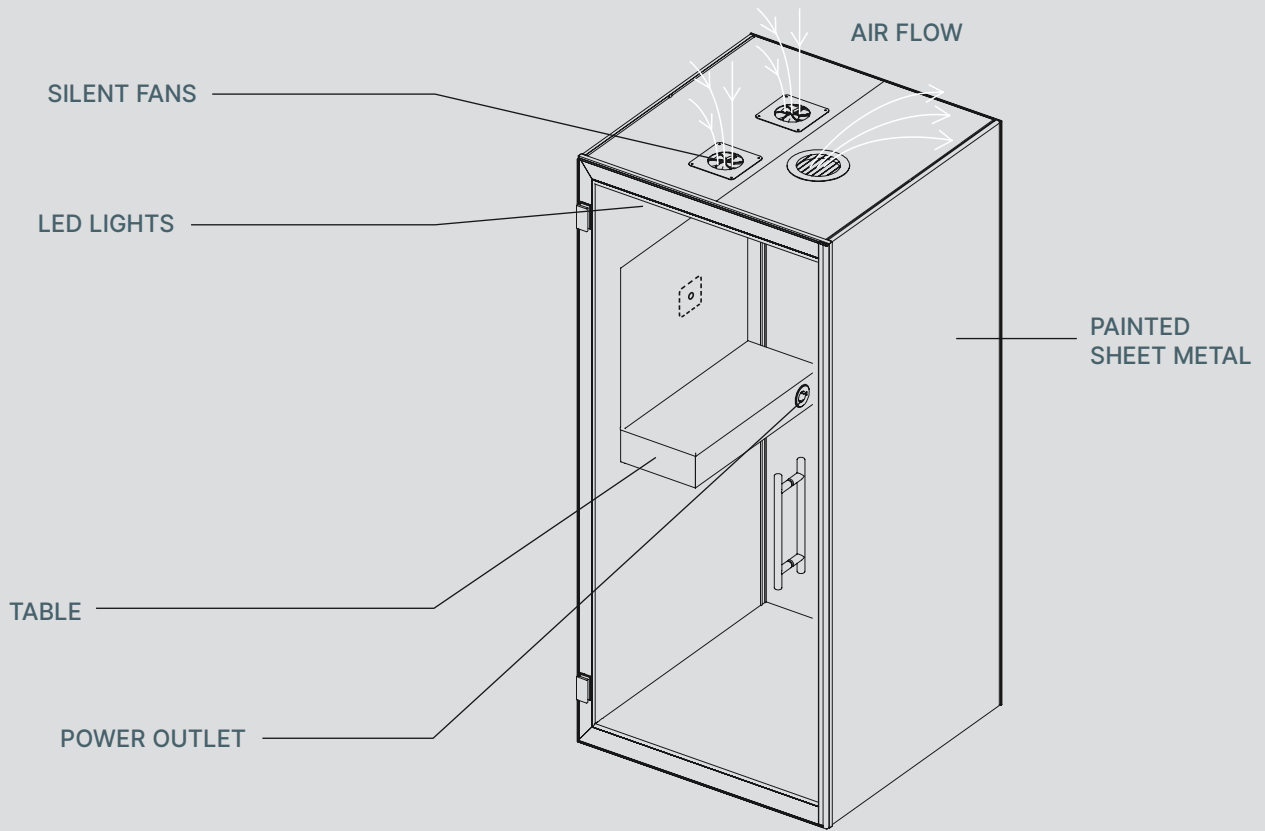

## CHATBOX SINGLE || PRICE

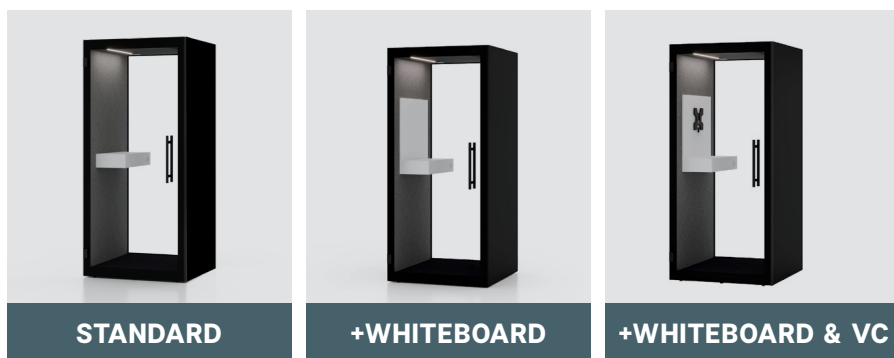
**\$11,000****\$11,999****\$12,299**

	<b>\$11,000</b>	<b>\$11,999</b>	<b>\$12,299</b>
LAMINATED SAFETY GLASS <sup>1</sup>	•	•	•
BLACK OR WHITE EXTERIOR FINISHES	•	•	•
DARK GRAY INTERIOR FINISH	•	•	•
DOOR HANDLE SIDE <sup>2</sup>	•	•	•
ANTIBACTERIAL WHITE TABLETOP <sup>3</sup>	•	•	•
INTEGRATED AIR CIRCULATION SYSTEM	•	•	•
LED LIGHT WITH PRESENCE SENSOR	•	•	•
ADJUSTABLE GLIDES <sup>4</sup>	•	•	•
STOOL WITH SWIVEL FUNCTION	\$643.50	\$643.50	\$643.50
INTEGRATED STOOL	\$999	\$999	\$999
WHITEBOARD	\$999	•	•
WHITEBOARD W/SCREEN BRACKET	\$1,299	\$1,299	•
AIR FLOW & LIGHTING DIMMER	\$800	\$800	\$800
COLOR COLLECTION UP-CHARGE	\$1,000	\$1,000	\$1,000

1. Sound control laminated safety glass. 2. Right-Handed or Left-Handed. 3. With one power socket 110-240 V (10 A) + USB (5 A).  
4. For easy leveling.



## CHATBOX SINGLE || ACCESSORIES



### INTEGRATED STOOL **\$999**

**DIAMETER:** 13.8"

**HEIGHT:** Min 22", Max 32.3"

**ADJUSTABLE LEG:** Black (chrome bottom tube)

**SEAT FABRIC:** Dark Gray - POD CS Col.9281  
Antracit\*

*\* Other colors available upon request. Custom colors for additional cost. Longer lead time may apply.*



### STOOL WITH SWIVEL FUNCTION **\$643.50**

**FRAME COLOR:** Black, Red, Gray

**MATERIAL:** Metal

**STOOL TURNS:** 360 degrees

**HEIGHT:** 29.9"

**WEIGHT:** 22 lb



### WHITEBOARD **\$999**

White magnetic laminate surface.

**WIDTH:** 27.6"

**HEIGHT:** 29.5"



### WHITEBOARD W/SCREEN BRACKET **\$1,299**

White magnetic laminate surface.

Universal bracket for 24" screen.

Screen not included.

VESA 100x100 and 200x200 mounting.

**WIDTH:** 27.6"

**HEIGHT:** 29.5"



### AIR FLOW & LIGHTING DIMMER **\$800**

## CHATBOX DUO

# Duo the box, Duo the fun.

Duo is perfect for 1-1 meetings and small brainstorm sessions.  
Up to four people can work in Duo, shoulder-to-shoulder.

**EXTERIOR:** (W x H x D) 83.9" x 87.4" x 40.4"

**INTERIOR:** (W x H x D) 78.7" x 80.3" x 36.5"

**PRODUCT WEIGHT:** 1212.5 lb

**PACKED ON PALLET:** 90.6" x 47.2" x 43.3"

**TOTAL WEIGHT:** 1279 lb



# CHATBOX DUO || SPECS

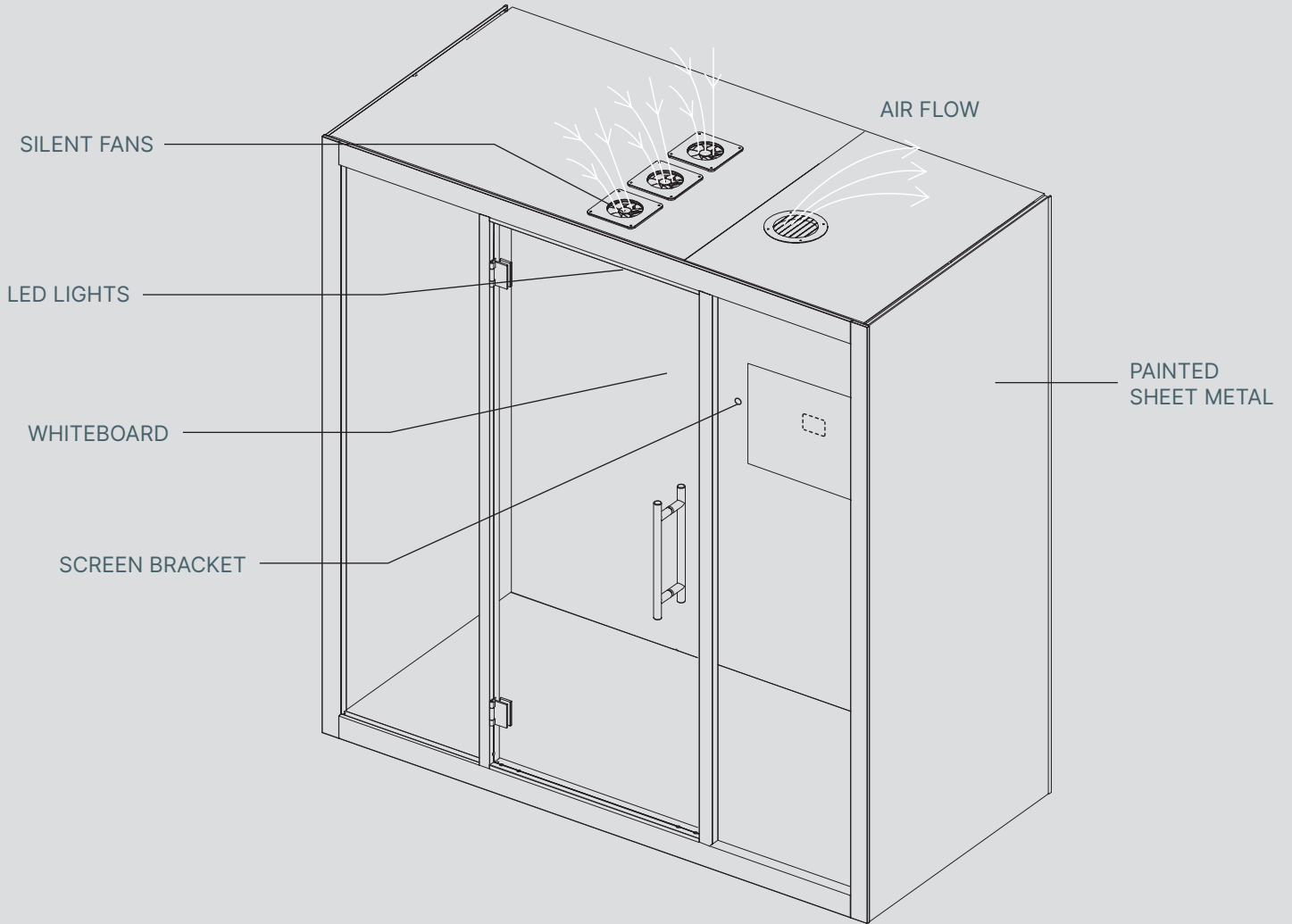

## CHATBOX DUO || PRICE

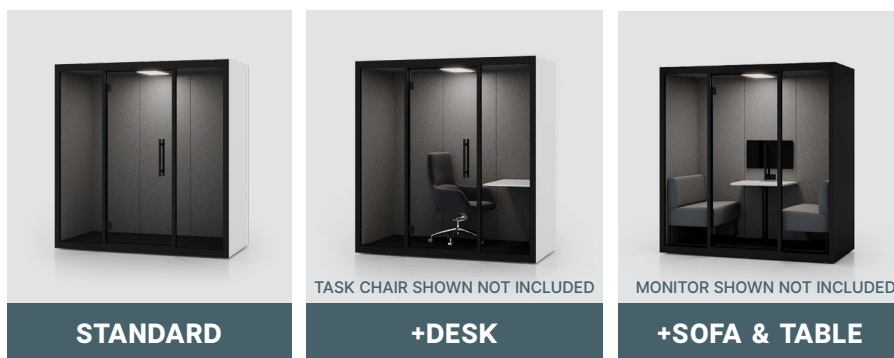
**\$24,000****\$26,880****\$28,100**

LAMINATED SAFETY GLASS <sup>1</sup>	•	•	•
BLACK OR WHITE EXTERIOR FINISHES	•	•	•
DARK GRAY INTERIOR FINISH	•	•	•
DOOR HANDLE SIDE <sup>2</sup>	•	•	•
ELECTRICAL CONNECTIONS <sup>3</sup>	•	•	•
INTEGRATED AIR CIRCULATION SYSTEM	•	•	•
LED LIGHT WITH PRESENCE SENSOR	•	•	•
LOW-BACK SOFA/PRICE PER UNIT	\$1,900	\$1,900	•
VC READY	\$1,000	\$1,000	\$1,000
MOVABLE LAPTOP TABLE	\$1,215	\$1,215	\$1,215
INTEGRATED TABLE	\$1,100	\$1,100	\$1,100
HEIGHT ADJUSTABLE TABLE	\$2,880	•	•
AIR FLOW & LIGHTING DIMMER	\$800	\$800	\$800
COLOR COLLECTION UP-CHARGE	\$1,200	\$1,200	\$1,200

1. Sound control laminated safety glass. 2. Right-Handed or Left-Handed. 3. 110-240 V (10 A) + USB (5 A).

## CHATBOX DUO || ACCESSORIES



### LOW-BACK SOFA

**\$1,900/PRICING PER UNIT**

Fabric name: POD in standard colors: Black, Dark gray or light gray. Other colors/fabric available on request.

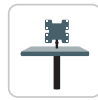

### HEIGHT ADJUSTABLE TABLE W/SCREEN BRACKET **\$3,375**

Universal bracket, for up to 32" screen.

Screen not included.

Screen bracket with cable management mounted to the table top.

VESA standard mounting.

**TABLETOP:** White (antibacterial) laminated MDF

**TABLE LEG:** Black

**TABLETOP DIMENSIONS:** 21.6" x 35.4"

**HEIGHT RANGE :** min 27.6", max 45.3"



### VC READY **\$1,000**

Universal bracket, for up to 32" screen.

Screen not include.

VESA standard mounting.

Cable pull through on wall with monitor cord to power monitor .



### MOVABLE LAPTOP TABLE **\$1,215**

**TABLETOP FINISH:** Dark brown oakwood plate

**TABLE LEG FINISH:** Graphite powder coat

**HEIGHT:** 27.2"

**WEIGHT:** 33 lb



### LAN/RJ45/HDMI CONNECTIONS **\$350**

Other power and data options available upon request (LAN, RJ45, HDMI, USB C)



### AIR FLOW & LIGHTING DIMMER **\$800**



### INTEGRATED TABLE **\$1,100**

Metal base hidden under carpet.

**TABLETOP:** White (antibacterial) laminated MDF

**TABLE LEG:** Black

**HEIGHT:** 28.7"

**TABLETOP DIMENSIONS:** 19.7" x 28.2"



### HEIGHT ADJUSTABLE TABLE **\$2,880**

**TABLETOP:** White (antibacterial) laminated MDF

**TABLE LEG:** Black

**TABLETOP DIMENSIONS:** 21.6" x 35.4"

**HEIGHT RANGE :** min 27.6", max 45.3"

## CHATBOX QUATTRO

# A private room in the middle of your open office.

Boost your productivity in an office that is a bit too open.

**EXTERIOR:** (W x H x D) 83.9" x 87.4" x 76.2"

**INTERIOR:** (W x H x D) 78.7" x 80.3" x 73.3"

**PRODUCT WEIGHT:** 2160 lb

**PACKED ON PALLET:** 90.6" x 47.2" x 59.1"

**TOTAL WEIGHT:** 2227 lb



# CHATBOX QUATTRO || SPECS

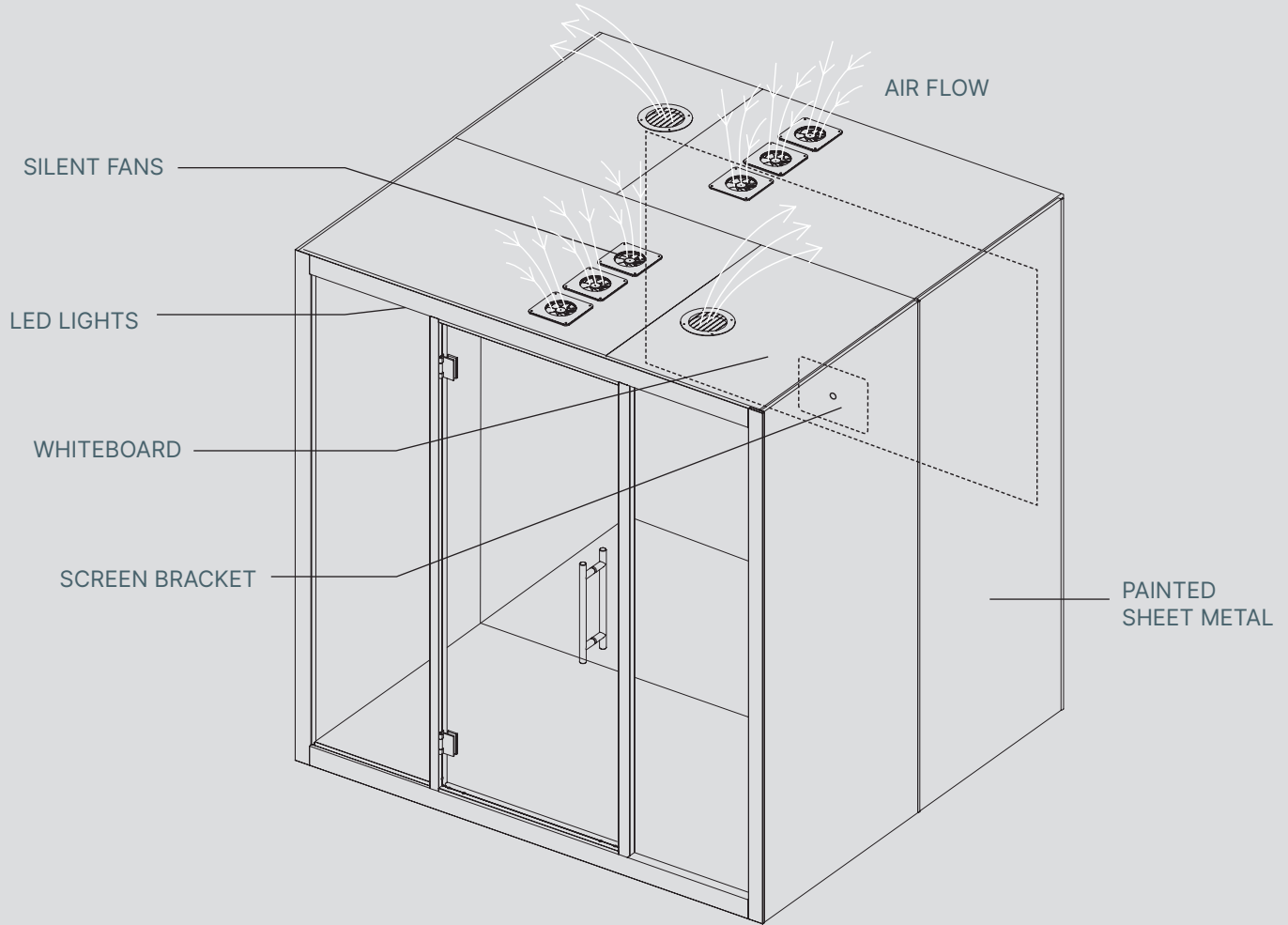

CHATBOX QUATTRO || **PRICE****STANDARD****+SOFA & TABLE****\$44,000****\$52,200**

	<b>STANDARD</b>	<b>+SOFA &amp; TABLE</b>
LAMINATED SAFETY GLASS <sup>1</sup>	•	•
BLACK OR WHITE EXTERIOR FINISHES	•	•
DARK GRAY INTERIOR FINISH	•	•
DOOR HANDLE SIDE <sup>2</sup>	•	•
ELECTRICAL CONNECTIONS <sup>3</sup>	•	•
INTEGRATED AIR CIRCULATION SYSTEM	•	•
LED LIGHT WITH PRESENCE SENSOR	•	•
LOW-BACK SOFA/PRICING PER UNIT	\$1,900	•
SCREEN BRACKET ON BACK GLASS	\$1,000	\$1,000
MOVABLE LAPTOP TABLE	\$1,215	\$1,215
INTEGRATED TABLE	\$1,100	•
AIR FLOW & LIGHTING DIMMER	\$800	\$800
COLOR COLLECTION UP-CHARGE	\$2,000	\$2,000

1. Sound control laminated safety glass. 2. Right-Handed or Left-Handed. 3. 110-240 V (10 A) + USB (5 A).



## CHATBOX QUATTRO || ACCESSORIES



### LOW-BACK SOFA

**\$1,900/PRICING PER UNIT**

Fabric name: POD in standard colors: Black, Dark gray or light gray. Other colors/fabric available on request.



### SCREEN BRACKET ON BACK GLASS **\$1,000**

Universal bracket, for up to 32" screen.

Screen not included.

VESA 100x100 and 200x200 mounting.



### INTEGRATED TABLE **\$1,100**

Metal base hidden under carpet.

**TABLETOP:** White (antibacterial) laminated MDF

**TABLE LEG:** Black

**HEIGHT:** 28.7"

**TABLETOP DIMENSIONS:** 19.7" x 28.2"



### MOVABLE LAPTOP TABLE **\$1,215**

**TABLETOP FINISH:** Dark brown oakwood plate

**TABLE LEG FINISH:** Graphite powder coat

**HEIGHT:** 27.2"

**WEIGHT:** 33 lb



### AIR FLOW & LIGHTING DIMMER **\$800**

# CHATBOX || COLOR COLLECTION



MISTY CREEK  
RAL 6033



EVERGREEN  
RAL 6020



ESTONIAN MUSTARD  
RAL 1024



WHITEBOARD PAINT  
RAL 9003



CHARMING SMOKE  
RAL 7039



SANGRIA  
RAL 4002



OCEAN TIDE  
RAL 5003

## FURNITURE OVERVIEW

### MEETER SOFA LOW-BACK FOR DUO AND QUATTRO



**LENGTH:** 35.4"

**HEIGHT:** 30.3"

**DEPTH:** 24.4"

**SOFA FABRIC STANDARD COLOR:** Black, Dark Gray, Light Gray \*

**FABRIC:** POD CS, Antibacterial & other fabrics available upon request.

*\* Other colors available upon request. Custom colors for additional cost. Longer lead time may apply.*

### STOOL WITH SWIVEL FUNCTION



**FRAME COLOR:** Black, Red, Gray

**MATERIAL:** Metal

**STOOL TURNS:** 360 degrees

**HEIGHT:** 29.9"

**WEIGHT:** 22 lb

### INTEGRATED STOOL (FIXED TO FLOOR)



**DIAMETER:** 13.8"

**HEIGHT:** Min 22", Max 32.3"

**ADJUSTABLE LEG:** Black (with chrome bottom tube)

**SEAT FABRIC:** Dark Gray - POD CS Col.9281 Antracit

*\* Other colors available upon request. Custom colors for additional cost. Longer lead time may apply.*

### HEIGHT ADJUSTABLE TABLE



Lifting mechanism located inside the wall module.

**TABLETOP:** White (antibacterial) laminated MDF

**TABLETOP DIMENSIONS:** 26.6" x 10.7"

**HEIGHT:** Min 27.6", Max 45.3"

### INTEGRATED CENTER TABLE FOR DUO



Integrated table without power outlet options (outlets only in the floor module) with metal base hidden under carpet.

**TABLETOP DIMENSIONS:** 23.6" x 29.1"

**HEIGHT:** 28.7"

**TABLETOP:** White (antibacterial) laminated MDF

**TABLE LEG:** Black

## FURNITURE OVERVIEW

### INTEGRATED CENTER TABLE FOR QUATTRO



Fixed to floor center of pod.

**TABLETOP:** White (antibacterial) laminated MDF

**TABLE LEG:** Black

**HEIGHT:** min 27"

**TABLETOP DIMENSIONS:** 63" x 29.1"

### MOVABLE TABLE



**TABLETOP FINISH:** Dark brown oakwood plate

**TABLE LEG FINISH:** Graphite powder coat

**HEIGHT:** 27.2"

**WEIGHT:** 33 lb

# silen

WE BRING SILENCE EVERYWHERE

# HOLMRIS



LIST USD || ISSUED SEPTEMBER 1, 2022  
SILENSPACE.COM

# ORDER CHECKLIST | silen

ALL SELECTIONS MUST BE SPECIFIED AT TIME OF ORDER.  
SEE FOLLOWING PAGE FOR COLOR OPTIONS.

## INTERIOR COLOR

Light gray, dark gray, or black.

## DOOR FRAME

Aluminum, white or black.  
Door handle color will match.

## TRIM

Can be separate color from exterior color.

## CARPET

Light gray, dark gray, or black.



## EXTERIOR COLOR

Standard: White, light gray, or black.  
Color Collection: Choice of 29 colors.  
Veneer Collection.

## DOOR HANDLE

Opens to the left or right.



Door opens to the left.  
(hinges on left)



Door opens to the right.  
(hinges on right)

## RETRACTABLE CASTERS

Standard on all models.

# FINISHES | silen

## STANDARD EXTERIOR



SNOW  
WHITE  
RAL 9003



LIGHT  
GRAY  
RAL 7035



BLACK  
RAL 9011

## VENEER EXTERIOR



OAK  
R0015



DARK OAK  
TH009

## COLOR COLLECTION EXTERIOR



MANGO  
RAL 080 80 60



BURNT  
ORANGE  
RAL 2001



JADE  
RAL 6027



ORANGE  
RAL 2008



AUBERGINE  
RAL 4004



CHILLI  
RAL 8029



BLUE TIBER  
RAL 5003



BLUE NAVY  
RAL 5007



QUARTZ  
RAL 1015



COAL  
RAL 6014



MINT  
RAL 6019



BORDEAUX  
RAL 3004



COTTON  
RAL 7044



AZURITE  
RAL 5008



FROZEN BLUE  
RAL 7040



SIGNAL GREEN  
RAL 6032



EDEN  
RAL 6005



BAMBUS  
RAL 7033



CAMOUFLAGE  
S 6010-C50Y



AQUAMARINE  
RAL 6033



OPAL  
RAL 5020



CITRUS GREEN  
RAL 100 80 60



CAPPUCCINO  
RAL 7006



BLUE IRIS  
RAL 250 80 10



HOT PEPPER  
RAL 3020



FRESH  
RAL 150 60 20



INDIAN  
SUMMER  
RAL 1035



BASALT  
RAL 7036



MARSHMALLOW  
S 1510-Y90R

## ALUMINUM PROFILES | DOORS + GLASS DOORS



WHITE<sup>1</sup>  
RAL 9003



ALUMINIUM<sup>2</sup>



BLACK<sup>3</sup>  
RAL 9005

## WALL AND CEILING | ECHO FREE ACOUSTIC PANELING



LIGHT GRAY  
1893



DARK GRAY  
1897



BLACK  
1961

## FLOOR | DESSO ESSENCE CARPET



LIGHT GRAY  
9506



DARK GRAY  
9501



BLACK  
9550

## SEATING FABRICS



POD CS 8033  
BLACK



POD CS 9804  
SILVER  
MELANGE



POD CS 9281  
ANTRACIT  
GRAY

1. **WHITE** - RAL 9003 Profiles + Gray Anodized Door Fitting
2. **ALUMINIUM** - Gray Anodized Profiles + Gray Anodized Door Fittings
3. **BLACK** - RAL 9005 Profiles + Black Door Fittings

## POWER

### SILEN I

X1 I10-240V (10A), X1 USB-A, X1 USB-C

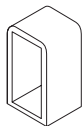

### SILEN 2

X2 I10-240V (10A), X2 USB (5A)

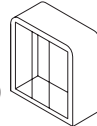

### SILEN 4

X2 I10-240V (10A), X2 USB (5A)

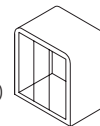

### SILEN MAX

X2 I10-240V (10A), X2 USB (5A)

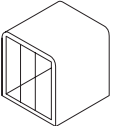

# TEXTILE SIDES (POD CS) | silen

ONLY FOR SILEN DYNAMICS

 WHITE POD CS 0001	 CREAM POD CS 1001	 BEIGE POD CS 1006	 COFFEE POD CS 2010	 DARK BROWN POD CS 2012	 TAUPE POD CS 2024	 OLIVE POD CS 3030	 ORANGE POD CS 3036	 SAFFRON POD CS 3090	 DARK GRAPE POD CS 4007	 BORDEAUX POD CS 4017	 WINE POD CS 4018	 SILVER POD CS 8078	 BLACK POD CS 8033	 STONE POD CS 8017
 LIME POD CS 7041	 GRASS POD CS 7025	 DARK GREEN POD CS 7014	 NAVY POD CS 6098	 PETROL POD CS 6014	 LAKE POD CS 6013	 TURQUOISE POD CS 6007	 PUMPKIN POD CS 4051	 RED POD CS 4028	 BROWN MELANGE POD CS 9108	 TAUPE MELANGE POD CS 9109	 SAND POD CS 9110	 ANTRACIT POD CS 9110	 ORANGE MELANGE POD CS 9301	 CURRY POD CS 9304
 OLIVE MELANGE POD CS 9305	 RED MELANGE POD CS 9401	 RED & BLUE MELANGE POD CS 9501	 SKY MELANGE POD CS 9601	 SEA POD CS 9602	 LILAC POD CS 9604	 PACIFIC POD CS 6091	 STONE MELANGE POD CS 9805	 SILVER MELANGE POD CS 9804	 SAND MELANGE POD CS 9703	 LIME MELANGE POD CS 9701	 TURQUOISE MELANGE POD CS 9610	 LAGOON POD CS 9609	 PETROL MELANGE POD CS 9608	 PLUM POD CS 9607
 LILAC MELANGE POD CS 9606	 PURPLE POD CS 9605													

OTHER FABRICS AVAILABLE UPON REQUEST.







HOUSTON

SI

- EXCELLENT FOR PRIVATE CALLS
- VIDEO CONFERENCING (OPTIONAL)
- INTEGRATED CASTERS FOR EASY MOVE
- LAMINATED SAFETY GLASS



GARGARIN

# SPACE 1 | silen

**A | STANDARD BASE MODEL:** Silen Space 1 is effective and ready for when you need a break from office noise and distractions. It's privacy for the user, and silence for the colleagues.

**B | GARGARIN MODEL:** Our Silen Space 1 pod is for those moments when you need to be completely isolated from everyone. With our comfortable integrated stool, you can be left alone to focus on what's important. Just like how Gagarin must have felt.

**C | HOUSTON MODEL:** Houston is our Silen Space 1 pod that has the ability to connect your own devices and install your own screen. When you have an urgent problem that needs to be solved, consult with Houston.

**EXTERIOR:** (W x H x D) 43" x 90" x 43"

**INTERIOR:** (W x H x D) 35" x 81" x 40"

**PRODUCT WEIGHT:** 816 lb

**PACKED WOODEN CRATE:** 36" x 93" x 55"

**TOTAL WEIGHT:** 1102 lb

MODEL	COST
<b>A   STANDARD BASE MODEL WITH WALL MOUNTED TABLE</b>	\$15,700
<b>B   GARGARIN WITH ANTIBACTERIAL TABLETOP + INTEGRATED STOOL</b>	\$16,800
<b>C   HOUSTON WITH ANTIBACTERIAL TABLETOP + VC READY</b>	\$17,025



# SPACE | DETAILS | silen

MODEL + DESCRIPTION	STANDARD	HOUSTON	GARGARIN
LAMINATED SAFETY GLASS <sup>1</sup>	•	•	•
EXTERIOR FINISHES <sup>2</sup>	•	•	•
INTERIOR FINISHES <sup>3</sup>	•	•	•
DOOR FITTING & DOOR FRAME FINISHES <sup>4</sup>	•	•	•
DOOR HANDLE SIDE <sup>5</sup>	•	•	•
FLOOR CARPET <sup>6</sup>	•	•	•
ANTIBACTERIAL WHITE TABLETOP <sup>7</sup>	•	•	•
OTHER POWER AND DATA OPTIONS AVAILABLE UPON REQUEST	•	•	•
INTEGRATED AIR CIRCULATION SYSTEM	•	•	•
LED LIGHT WITH PRESENCE SENSOR	•	•	•
ADJUSTABLE GLIDES <sup>8</sup>	•	•	•
CONCEALED CASTERS <sup>9</sup>	•	•	•
SCREEN BRACKET - FULL/VC READINESS	\$1,325	•	•
STOOL WITH SWIVEL FUNCTION	\$715	\$715	\$715
INTEGRATED STOOL	\$1,100	\$1,100	•

1. LAMINATED SAFETY GLASS - 66.2 Sound control Rw 40 dB

2. EXTERIOR FINISH - 3 Standard + 31 custom (additional cost).

3. INTERIOR FINISH - 3 Standard colors.

4. DOOR FITTING & DOOR FRAME FINISH - 3 Standard colors.

5. DOOR FITTING & DOOR FRAME FINISH - 3 Standard colors.

6. FLOOR CARPET - 3 Standard colors.

7. ANTIBACTERIAL WHITE TABLETOP - With one power socket 110-240 V (10 A) + USB (5 A). Other power and data options available upon request

8. ADJUSTABLE GLIDES - For easy leveling.

9. CONCEALED CASTERS - Easy to relocate in a room.

# SPACE | ACCESSORIES | silen

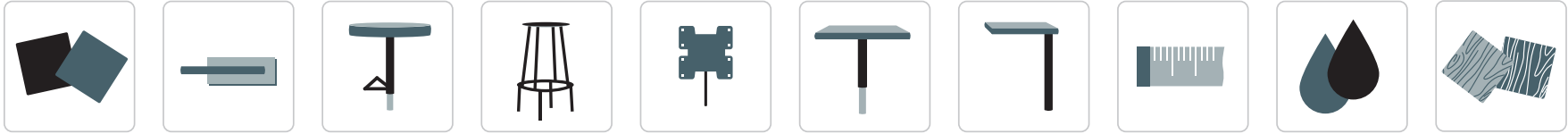

MODEL + DESCRIPTION	PRICE
SILEN DYNAMICS GENERATION <sup>1</sup>	\$425
ANTIBACTERIAL HANDLE	\$215
INTEGRATED STOOL <sup>2</sup>	\$1,100
STOOL WITH SWIVEL FUNCTION <sup>3</sup>	\$715
VC READY <sup>4</sup>	\$1,325
ELECTRIC HEIGHT ADJUSTABLE TABLE <sup>5</sup>	\$2,500
TABLE AT SITTING HEIGHT <sup>6</sup>	\$1,000
DEEPER TABLETOP <sup>7</sup>	\$425
CUSTOM COLOR LAMINATE	\$1,245
VENEER EXTERIOR	\$2,000

1. SILEN DYNAMICS GENERATION - Easily exchange side skins and cover trims.

2. INTEGRATED STOOL - DIAMETER: 13.8" HEIGHT: Min 22", Max 32.3" ADJUSTABLE LEG: Black (chrome bottom tube) SEAT FABRIC: Dark Gray - POD CS Col.9281 Antracit (Other colors available upon request. Custom colors for additional cost. Longer lead time may apply.)

3. STOOL WITH SWIVEL FUNCTION - FRAME COLOR: Black, Red, Gray MATERIAL: Metal STOOL TURNS: 360 degrees HEIGHT: 29.9" WEIGHT: 22 lb

4. VC READY - Universal bracket for up to 24" screen. Screen not included. VESA 100x100 and 200x200 mounting. Extra lights for improved video calls.

5. ELECTRIC HEIGHT ADJUSTABLE TABLE - Lifting mechanism located inside the wall module. TABLETOP: White (antibacterial) laminated MDF TABLETOP DIMENSIONS: 26.6" x 10.7" HEIGHT: Min 27.6", Max 45.3"

6. TABLE AT SITTING HEIGHT - HEIGHT: 28.75"

7. DEEPER TABLETOP - DEPTH: 14.7"

# SPACE I ACCESSORIES | silen

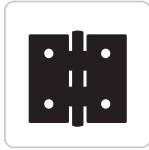

## MODEL + DESCRIPTION

## PRICE

SELF-CLOSING HINGES<sup>1</sup>

\$1,525

LAN CABLE 6M

\$335

AIRFLOW AND LIGHT DIMMER

\$888

OCCUPANCY INDICATOR LIGHT

CALL

SPRINKLER PREP<sup>2</sup>

\$400

SEISMIC KIT<sup>3</sup>

\$950

DOOR LOCK<sup>4</sup>

\$450

SPACE I WITHOUT CASTER OPTION<sup>5</sup>

CALL

REPLACEMENT COVER TRIMS SET

\$1,700

REPLACEMENT SIDES SET HPL

\$1,700

REPLACEMENT SIDES SET VENEERED

\$2,000

REPLACEMENT SIDES SET TEXTILE POD CS

\$3,500

**1. SELF-CLOSING HINGES - FINISH:** Anodized Aluminum and Black

**2. SPRINKLER PREP** - Knockout with a tube inside the ceiling module for housing a sprinkler. Sprinkler not included. Sprinkler needs to be installed by a certified company.

**3. SEISMIC KIT** - Brackets to mount the floor module to the existing floor with anchor bolts.

**4. DOOR LOCK** - Includes lock case with a DIN lock cylinder.

**5. SPACE 1 NO CASTER OPTION** - Available on request with a MOQ of 25 units.



## LUNAR ECLIPSE

### S2

- CREATE AND COLLABORATE
- LOW & HIGH-BACK SOFAS
- TEAM MEETINGS
- SOUND REDUCTION



## SOLAR ECLIPSE



## SIRIUS

# SPACE 2 | silen

**A | STANDARD BASE MODEL:** Every team needs a space to meet, create and collaborate. Silen Space 2 is a stylish interior space where you can fit up to four people. It can even adapt to your business's needs, no matter how big or small.

**B | SIRIUS MODEL:** Sirius is often, and incorrectly, referred to as the brightest star in the night's sky. It is actually a binary star system, highlighting the importance of balance and collaboration. Sirius Workstation offers an environment that fosters creativity and concentration.

**C | LUNAR MODEL:** Silen Space 2 pods are for when you really need to block everything out. Silen Space 2 has been recorded to have the industry-leading sound reduction; our Silen Space 2 can empower you to block out almost as much as an eclipse does.

**D | SOLAR MODEL:** Silen Space 2 pods are for when you really need to block everything out. Silen Space 2 has been recorded to have the industry-leading sound reduction; our Silen Space 2 can empower you to block out almost as much as an eclipse does.

**EXTERIOR:** (W x H x D) 94" x 90" x 95"

**INTERIOR:** (W x H x D) 87" x 81" x 93"

**PRODUCT WEIGHT:** 2646 lb

**PACKED WOODEN CRATE:** 36" x 95" x 57"

**TOTAL WEIGHT:** 3219 lb

## MODEL

**A | STANDARD BASE MODEL**

**B | SIRIUS WITH ANTIBACTERIAL TABLETOP + SCREEN BRACKET**

**C | LUNAR ECLIPSE WITH ANTIBACTERIAL TABLETOP + LOW-BACK SOFAS**

**D | SOLAR ECLIPSE WITH (2) MOVABLE LAPTOP TABLES + HIGH-BACK SOFAS**

## COST

\$38,000

\$40,500

\$43,200

\$46,000

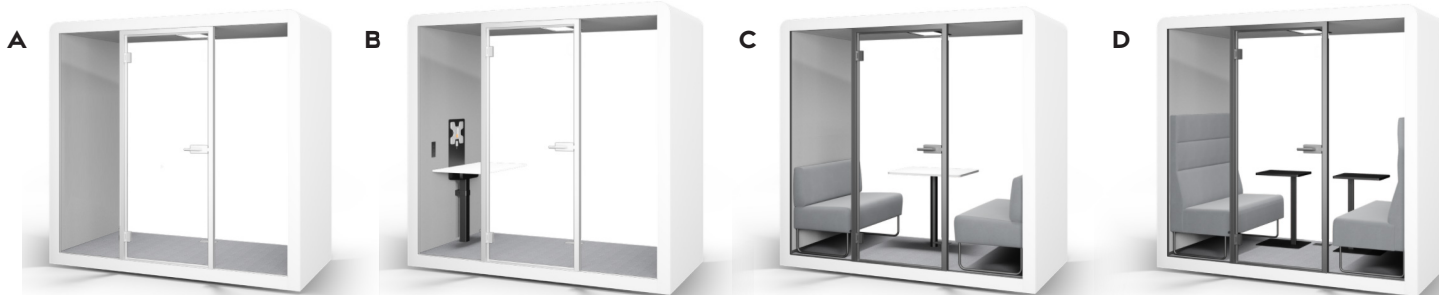



# SPACE 2 DETAILS | silen

MODEL + DESCRIPTION	STANDARD	LUNAR	SOLAR	SIRIUS
LAMINATED SAFETY GLASS <sup>1</sup>	•	•	•	•
EXTERIOR FINISHES <sup>2</sup>	•	•	•	•
INTERIOR FINISHES <sup>3</sup>	•	•	•	•
DOOR FITTING & DOOR FRAME FINISHES <sup>4</sup>	•	•	•	•
FLOOR CARPET <sup>5</sup>	•	•	•	•
DOOR HANDLE SIDE <sup>6</sup>	•	•	•	•
ELECTRICAL CONNECTIONS <sup>7</sup>	•	•	•	•
INTEGRATED AIR CIRCULATION SYSTEM	•	•	•	•
LED LIGHT WITH PRESENCE SENSOR	•	•	•	•
ADJUSTABLE GLIDES <sup>8</sup>	•	•	•	•
CONCEALED CASTERS <sup>9</sup>	•	•	•	•
POSSIBLE COMBINE 2 OR 3 SPACE 2 ROOMS	•	•	•	•
COMFORT-FOCUSED LOW-BACK SOFAS (PER UNIT)	\$2,000	•	\$2,000	\$2,000
DESIGNER-FRIENDLY HIGH-BACK SOFAS (PER UNIT)	\$2,800	\$2,800	•	\$2,800
INTEGRATED TABLE WITH ANTIBACTERIAL TOP	\$1,200	•	\$1,200	•
HEIGHT ADJUSTABLE TABLE WITH ANTIBACTERIAL TOP	\$2,400	\$2,400	\$2,400	\$2,400
MOVABLE LAPTOP TABLES (2 PIECES)	\$2,000	\$2,000	•	\$2,000

1. LAMINATED SAFETY GLASS - 66.2 Sound control Rw 40 dB

2. EXTERIOR FINISHES - 3 Standard + 31 custom (additional cost).

3. INTERIOR FINISHES - 3 Standard colors.

4. DOOR FITTING & DOOR FRAME FINISHES - 3 Standard colors.

5. FLOOR CARPET - 3 Standard colors.

6. DOOR HANDLE SIDE - Right-Handed or Left-Handed.

7. ELECTRICAL CONNECTIONS - Option one: double 110-240 V (10 A) Option two: 110-240 V (10 A) + 2 x USB (5 A) \* Other power and data options available upon request.

8. ADJUSTABLE GLIDES - For easy leveling.

9. CONCEALED CASTERS - Easy to relocate in a room.

# SPACE 2 ACCESSORIES | silen

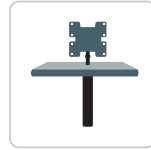
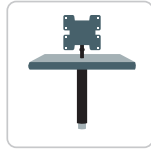
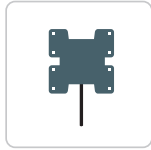
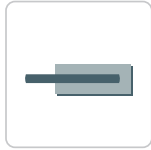

## MODEL + DESCRIPTION

## PRICE

SILEN DYNAMICS GENERATION<sup>1</sup>

\$425

ANTIBACTERIAL HANDLE

\$215

SCREEN BRACKET ON BACK GLASS<sup>2</sup>

\$955

SCREEN BRACKET ON SIDE WALL<sup>3</sup>

\$1,400

INTEGRATED TABLE<sup>4</sup>

\$1,200

INTEGRATED TABLE WITH SWIVEL SCREEN MOUNT<sup>5</sup>

\$3,500

ADDITIONAL POWER OUTLET UNDER TABLE<sup>6</sup>

\$1,180

ADDITIONAL POWER OUTLET EXTRA FLOOR BOX<sup>7</sup>

\$900

ADDITIONAL POWER OUTLET ON WALL MODULE<sup>8</sup>

\$1,050

**1. SILEN DYNAMICS GENERATION** - Easily exchange side skins and cover trims.

**2. SCREEN BRACKET ON BACK GLASS** - Bracket attached to back glass module with a center height of 49.2". Universal bracket for up to 43" screen. Screen not included. VESA 100x100 and 200x200 mounting.

**3. SCREEN BRACKET ON SIDE WALL** - 2x power outlet on wall module H=55.12 in, screen bracket mounted on site, height can vary. Universal bracket for up to 43" screen. Screen not included. VESA 100x100 and 200x200 mounting. Specify wall location when ordering (left or right).

**4. INTEGRATED TABLE - TABLETOP DIMENSIONS:** 23.6" x 29.1" **HEIGHT:** 28.7" **TABLETOP:** White (antibacterial) laminated MDF **TABLE LEG:** Black Bigger top available upon request.

**5. INTEGRATED TABLE WITH SWIVEL SCREEN MOUNT** - Universal bracket for 27" screen. Screen not included. VESA 100x100 and 200x200 mounting. Available only with integrated table. Cable tray under the table. Includes power outlet (2 x 230V +1 x USB-A+1 x USB-C) under the table.

**6. ADDITIONAL POWER OUTLET UNDER TABLE** - 2 x 230V +1 x USB-A +1 x USB-C

**7. ADDITIONAL POWER OUTLET EXTRA FLOOR BOX** - Location next to existing floor outlet. **OPTION ONE:** Double 110-240 V (10 A) **OPTION TWO:** 110-240 V (10 A) + 2 x USB (5 A)

**8. ADDITIONAL POWER OUTLET ON WALL MODULE** - Power outlet on left wall module next to back glass wall.

# SPACE 2 ACCESSORIES | silen

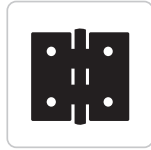
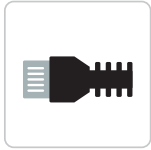

## MODEL + DESCRIPTION

## PRICE

LAN/RJ45/HDMI CONNECTIONS<sup>1</sup>

CALL

CUSTOM COLOR LAMINATE

\$1,350

VENEER EXTERIOR

\$2,000

TEXTILE SIDES (POD CS)

\$2,300

SELF-CLOSING HINGES<sup>2</sup>

\$1,525

AIR FLOW & LIGHTING DIMMER

\$888

OCCUPANCY INDICATOR LIGHT

CALL

FROSTED FILM ON REAR GLASS<sup>3</sup>

\$775

FROSTED FILM ON REAR GLASS<sup>4</sup>

\$900

SPRINKLER PREP<sup>5</sup>

\$400

SEISMIC KIT<sup>6</sup>

\$950

**1. LAN/RJ45/HDMI CONNECTIONS** - Other power & data options available upon request. (LAN, RJ45, HDMI, USB C)

**2. SELF-CLOSING HINGES - FINISH:** Anodized Aluminium and Black

**3. FROSTED FILM ON REAR GLASS** - Frosted film between glasses.

**4. FROSTED FILM ON REAR GLASS** - Frosted film on glass (inside or outside). The exterior privacy film is prone to scratches.

**5. SPRINKLER PREP** - Knockout with a tube inside the ceiling module for housing a sprinkler. Does not include a sprinkler. Sprinkler needs to be installed by a certified company.

**6. SEISMIC KIT** - Brackets to mount the floor module to the existing floor with anchor bolts.

# SPACE 2 ACCESSORIES | silen



MODEL + DESCRIPTION	PRICE
REPLACEMENT COVER TRIM SET	\$1,700
REPLACEMENT SIDES SET HPL	\$1,700
REPLACEMENT SIDES SET VENEERED	\$2,000
REPLACEMENT SIDES SET TEXTILE POD CS	\$3,500
EXTENSION MODULE <sup>1</sup>	\$3,300
CONNECTION KIT <sup>2</sup>	\$1,300

**1. EXTENSION MODULE** - An extension module to create Space 4 with existing Space 2. Without glasses and covering trims.

**2. CONNECTION KIT** - A kit to connect two Space 2 rooms into one Space 4. Includes 8 x connecting rods and 4 x interior trim pieces.



LUNAR ECLIPSE

## S4

- BRAINSTORMING SESSIONS
- ACCOMMODATES UP TO 8 PEOPLE
- INTEGRATED CIRCULATION SYSTEM
- AIR PURIFIER WITH HEPA FILTER



SOLAR ECLIPSE

# SPACE 4 | silen

**A | STANDARD BASE MODEL:** Silen Space 4 is the optimal space to hold your brainstorming sessions and easily accommodates up to eight people. The space is also effective for small team building exercises and important meetings.

**B | LUNAR ECLIPSE MODEL:** Silen Space 4 pods are for when you really need to block everything out. Silen Space 4 has been recorded to have the industry-leading sound reduction; our Silen Space 4 can empower you to block out almost as much as an eclipse does.

**C | SOLAR ECLIPSE MODEL:** Silen Space 4 pods are for when you really need to block everything out. Silen Space 4 has been recorded to have the industry-leading sound reduction; our Silen Space 4 can empower you to block out almost as much as an eclipse does.

**EXTERIOR:** (W x H x D) 94" x 90" x 95"

**INTERIOR:** (W x H x D) 87" x 81" x 93"

**PRODUCT WEIGHT:** 2646 lb

**PACKED WOODEN CRATE:** 36" x 95" x 57"

**TOTAL WEIGHT:** 3219 lb

## MODEL

## COST

**A | STANDARD BASE MODEL**

\$62,000

**B | LUNAR ECLIPSE WITH ANTIBACTERIAL TABLETOP + LOW-BACK SOFAS**

\$71,200

**C | SOLAR ECLIPSE WITH (4) MOVABLE LAPTOP TABLES + HIGH-BACK SOFAS**

\$77,500



# SPACE 4 DETAILS | silen

MODEL + DESCRIPTION	STANDARD	LUNAR ECLIPSE	SOLAR ECLIPSE
LAMINATED SAFETY GLASS <sup>1</sup>	•	•	•
EXTERIOR FINISHES <sup>2</sup>	•	•	•
INTERIOR FINISHES <sup>3</sup>	•	•	•
DOOR FITTING & DOOR FRAME FINISHES <sup>4</sup>	•	•	•
FLOOR CARPET <sup>5</sup>	•	•	•
DOOR HANDLE SIDE <sup>6</sup>	•	•	•
ELECTRICAL CONNECTIONS <sup>7</sup>	•	•	•
INTEGRATED AIR CIRCULATION SYSTEM	•	•	•
LED LIGHT WITH PRESENCE SENSOR	•	•	•
ADJUSTABLE GLIDES <sup>8</sup>	•	•	•
CONCEALED CASTERS <sup>9</sup>	•	•	•
POSSIBLE TO SPLIT A SPACE 4 ROOM INTO TWO SPACE 2 ROOMS	•	•	•
COMFORT-FOCUSED LOW-BACK SOFAS (PER UNIT)	\$2,000	•	\$2,000
DESIGNER-FRIENDLY HIGH-BACK SOFAS (PER UNIT)	\$2,800	\$2,800	•
INTEGRATED TABLE WITH ANTIBACTERIAL TOP	\$1,800	•	\$1,800
MOVABLE LAPTOP TABLES (4 PIECES)	\$4,000	\$4,000	•

1. LAMINATED SAFETY GLASS - 66.2 Sound control Rw 40 dB

2. EXTERIOR FINISHES - 3 Standard + 31 custom (additional cost).

3. INTERIOR FINISHES - 3 Standard colors.

4. DOOR FRAME & DOOR FRAME FINISHES - 3 Standard colors.

5. FLOOR CARPET - 3 Standard colors.

6. DOOR HANDLE SIDE - Right-Handed or Left-Handed.

7. ELECTRICAL CONNECTIONS - **OPTION ONE:** double 110-240 V (10 A)    **OPTION TWO:** 110-240 V (10 A) + 2 x USB (5 A) (Other power and data options available upon request.)

8. ADJUSTABLE GLIDES - For easy leveling.

9. CONCEALED CASTERS - Easy to relocate in a room.

# SPACE 4 ACCESSORIES | silen

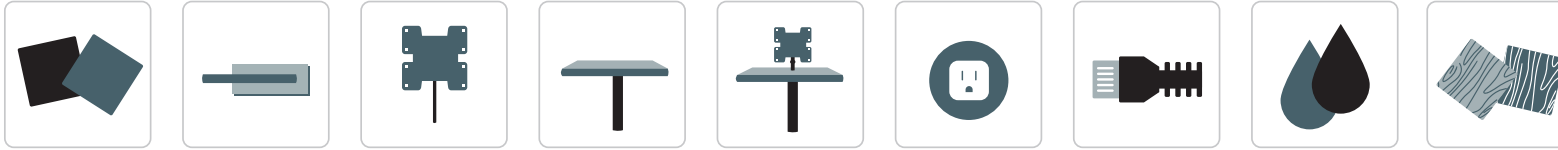

MODEL + DESCRIPTION	PRICE
SILEN DYNAMICS GENERATION <sup>1</sup>	\$1,000
ANTIBACTERIAL HANDLE	\$215
SCREEN BRACKET ON BACK GLASS <sup>2</sup>	\$955
SCREEN BRACKET ON SIDE WALL <sup>3</sup>	\$955
INTEGRATED TABLE <sup>4</sup>	\$1,800
INTEGRATED TABLE WITH SWIVEL SCREEN MOUNT <sup>5</sup>	\$4,200
ADDITIONAL POWER OUTLET <sup>6</sup>	\$1,180
LAN/RJ45/HDMI CONNECTIONS <sup>7</sup>	CALL
CUSTOM COLOR LAMINATE	\$2,600
VENEER EXTERIOR	\$4,200

**1. SILEN DYNAMICS GENERATION** - Easily exchange side skins and cover trims.

**2. SCREEN BRACKET ON BACK GLASS** - Bracket attached to back glass module with a center height of 49.2". Universal bracket for up to 43" screen. Screen not included. VESA 100x100 and 200x200 mounting.

**3. SCREEN BRACKET ON SIDE WALL** - 2x power outlet on wall module H=55.12 in, screen bracket mounted on site, height can vary. Universal bracket for up to 43" screen. Screen not included. VESA 100x100 and 200x200 mounting. Specify wall location when ordering (left or right).

**4. INTEGRATED TABLE - TABLETOP DIMENSIONS:** 23.6" x 29.1" **HEIGHT:** 28.7" **TABLETOP:** White (antibacterial) laminated MDF **TABLE LEG:** Black Bigger top available upon request.

**5. INTEGRATED TABLE WITH SWIVEL SCREEN MOUNT** - Universal bracket for 27" screen. Screen not included. VESA 100x100 and 200x200 mounting. Available only with integrated table. Cable tray under the table. Includes power outlet (2 x 230V +1 x USB-A+1 x USB-C) under the table.

**6. ADDITIONAL POWER OUTLET** - Additional power outlet under the table. 2 x 230V +1 x USB-A +1 x USB-C. Cables routed through the leg.

**7. LAN/RJ45/HDMI CONNECTIONS** - Other power & data options available upon request. (LAN, RJ45, HDMI, USB C)



# SPACE 4 ACCESSORIES | silen

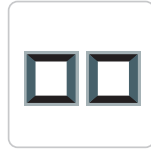
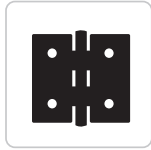

## MODEL + DESCRIPTION

## PRICE

TEXTILE SIDES (POD CS)<sup>1</sup>

\$4,600

SELF-CLOSING HINGES<sup>2</sup>

\$1,525

AIR FLOW AND LIGHTING DIMMER

\$888

OCCUPANCY INDICATOR LIGHT

CALL

SEPARATION KIT<sup>3</sup>

\$9,800

FROSTED FILM ON REAR GLASS<sup>4</sup>

\$1,200

FROSTED FILM ON REAR GLASS<sup>5</sup>

\$1,400

EXTENSION MODULE<sup>6</sup>

\$33,000

CONNECTION KIT<sup>7</sup>

\$1,300

SPRINKLER PREP<sup>8</sup>

\$830

SEISMIC KIT<sup>9</sup>

\$1,900

REPLACEMENT COVER TRIMS SET

\$1,700

REPLACEMENT SIDES SET HPL

\$3,400

REPLACEMENT SIDES SET VENEERED

\$4,000

REPLACEMENT SIDES SET TEXTILE POD CS

\$7,000

**1. TEXTILE SIDES (POD CS):** Only for Silen Dynamics.

**2. SELF-CLOSING HINGES - FINISH:** Anodized Aluminum and Black.

**3. SEPARATION KIT** - A kit to split Space 4 room into two Space 2 rooms. Includes front and back glass set, door and a set of covering trims.

**4. FROSTED FILM ON REAR GLASS** - Frosted film between glasses.

**5. FROSTED FILM ON REAR GLASS** - Frosted film on glass (inside or outside). The exterior privacy film is prone to scratches.

**6. EXTENSION MODULE** - An extension module to create Space 6 with existing Space 4. Without glasses and covering trims.

**7. CONNECTION KIT** - A kit to connect Space 4 into one Space 6 with extension module. Includes connections.

**8. SPRINKLER PREP** - Knockout with a tube inside the ceiling module for housing a sprinkler. Does not include a sprinkler. Sprinkler needs to be installed by a certified company.

**9. SEISMIC KIT** - Brackets to mount the floor module to the existing floor with anchor bolts.



NEBULA

# MAX

- HOLD MEETINGS & SEMINARS
- VC READY
- LARGE SOFAS
- STORAGE UNITS



SUPERNOVA



GALAXY

# SPACE MAX | silen

**A | STANDARD BASE MODEL:** This space is a real crowd pleaser, because that's what it does. Big ideas need a big and spacious environments. Silen Space Max is the space for your whole team to brainstorm new ideas or hold meetings and seminars for extended periods.

**B | NEBULA MODEL:** A nebula is a large gas cloud where stars are formed. Our Silen Space Max Corner Lounge was designed to birth something just as spectacular, great ideas. With its comfortable corner lounges and relaxed vibe, it is the optimal space for those important brainstorming sessions.

**C | SUPERNOVA MODEL:** A supernova is a massive explosion of light and energy. Our Space Max Meeting Room is the only room suited to contain the passionate ideas that you're willing to fight for.

**D | GALAXY MODEL:** A galaxy brings together stars in a solar system. Our Space Max Galaxy brings together people to discuss and share their bright ideas in a comfortable lounge-like meeting room.

**EXTERIOR:** (W x H x D) 110" x 90" x 95"

**INTERIOR:** (W x H x D) 102" x 81" x 93"

**PRODUCT WEIGHT:** 3307 lb

**PACKED WOODEN CRATE 1:** 35.4" x 94.5" x 57.1"

**PACKED WOODEN CRATE 2:** 35.4" x 110.2" x 35.4"

**TOTAL WEIGHT:** 3968 lb

**MAX ELEMENT SIZE:** 102.4" X 47.2"

MODEL	COST
<b>A   STANDARD BASE MODEL</b>	\$66,000
<b>B   NEBULA WITH (3) MOVABLE LAPTOP TABLES + WRAP-AROUND SOFA</b>	\$80,500
<b>C   SUPERNOVA WITH VC READY + INTEGRATED MEETING TABLE<sup>1</sup></b>	\$80,000
<b>D   GALAXY WITH STORAGE UNIT ON WALL + L-SHAPED SOFA<sup>2</sup></b>	\$81,000

<sup>1.</sup> **SUPERNOVA** - VC Ready Screen Bracket. Whiteboard. Extra Door. Power Socket + USB-A + HDMI on Sidewall. Integrated Meeting Table.

<sup>2.</sup> **GALAXY** - L-Shaped Sofa. Storage Unit on Wall. Whiteboard with Screen Bracket. (2) Movable Laptop Table.



# SPACE MAX DETAILS | silen

MODEL + DESCRIPTION	STANDARD	NEBULA	SUPERNOVA	GALAXY
LAMINATED SAFETY GLASS <sup>1</sup>	•	•	•	•
EXTERIOR FINISHES <sup>2</sup>	•	•	•	•
INTERIOR FINISHES <sup>3</sup>	•	•	•	•
DOOR FITTING & DOOR FRAME FINISHES <sup>4</sup>	•	•	•	•
FLOOR CARPET <sup>5</sup>	•	•	•	•
DOOR HANDLE SIDE <sup>6</sup>	•	•	•	•
ELECTRICAL CONNECTIONS <sup>7</sup>	•	•	•	•
INTEGRATED AIR CIRCULATION SYSTEM	•	•	•	•
LED LIGHT WITH PRESENCE SENSOR	•	•	•	•
ADJUSTABLE GLIDES <sup>8</sup>	•	•	•	•
CONCEALED CASTERS <sup>9</sup>	•	•	•	•
POSSIBLE TO COMBINE TWO SPACE MAX ROOMS TOGETHER	•	•	•	•
WRAP-AROUND SOFA	\$10,900	•	\$10,900	\$10,900
MOVABLE LAPTOP TABLES (4 PIECES)	\$4,000	•	\$4,000	•
WHITEBOARD WITH SCREEN BRACKET	\$3,500	\$3,500	•	•
EXTRA DOOR	\$2,800	\$2,800	•	\$2,800
INTEGRATED MEETING TABLE	\$4,900	\$4,900	•	\$?
L-SHAPED SOFA	\$8,000	\$8,000	\$8,000	•
STORAGE UNIT ON WALL	\$7,000	\$7,000	\$7,000	•

1. LAMINATED SAFETY GLASS - 66.2 Sound control Rw 40 dB

2. EXTERIOR FINISHES - 3 Standard + 31 custom (additional cost).

3. INTERIOR FINISHES - 3 Standard colors.

4. DOOR FITTING & DOOR FRAME FINISHES - 3 Standard colors.

5. FLOOR CARPET - 3 Standard colors.

6. DOOR HANDLE SIDE - Right-Handed or Left-Handed.

7. ELECTRICAL CONNECTIONS - Option one: double 110-240 V (10 A) Option two: 110-240 V (10 A) + 2 x USB (5 A) \* Other power and data options available upon request.

8. ADJUSTABLE GLIDES - For easy leveling.

9. CONCEALED CASTERS Easy to relocate in a room.

# SPACE MAX ACCESSORIES | silen

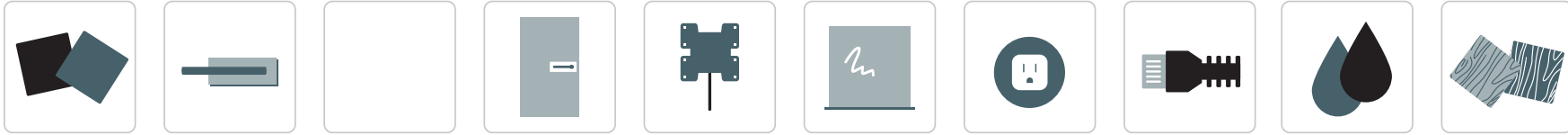

MODEL + DESCRIPTION	PRICE
SILEN DYNAMICS GENERATION <sup>1</sup>	\$1,000
ANTIBACTERIAL HANDLE	\$215
EXTRA DOOR	\$2,800
SCREEN BRACKET ON BACK GLASS <sup>2</sup>	\$955
SCREEN BRACKET ON SIDE WALL <sup>3</sup>	\$955
WHITEBOARD WITH SCREEN BRACKET <sup>4</sup>	\$3,500
POWER SOCKET + USB-A + HDMI ON SIDE WALL <sup>5</sup>	\$1,400
LAN/RJ45/HDMI CONNECTIONS <sup>6</sup>	CALL
CUSTOM COLOR LAMINATE	\$2,600
VENEER EXTERIOR	\$4,400

**1. SILEN DYNAMICS GENERATION** - Easily exchange side skins and cover trims.

**2. SCREEN BRACKET ON BACK GLASS** - Universal bracket for up to 40" screen. Screen not included. VESA 100x100 and 200x200 mounting.

**3. SCREEN BRACKET ON SIDE WALL** - Universal bracket for up to 40" screen. Screen not included. VESA 100x100 and 200x200 mounting. Specify wall location when ordering (left or right).

**4. WHITEBOARD WITH SCREEN BRACKET:** Dimensions: 2000x1000 mm. Magnetic high gloss surface. V/C ready screen bracket.

**5. LAN/RJ45/HDMI CONNECTIONS** - Other power & data options available upon request. (LAN, RJ45, HDMI, USB C)

# SPACE MAX ACCESSORIES | silen

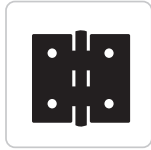

## MODEL + DESCRIPTION

## PRICE

TEXTILE SIDES (POD CS)

\$4,800

SELF-CLOSING HINGES (PER DOOR)<sup>1</sup>

\$1,500

AIR FLOW AND LIGHTING DIMMER

\$888

OCCUPANCY INDICATOR LIGHT

CALL

FROSTED FILM ON REAR GLASS<sup>2</sup>

\$1,200

FROSTED FILM ON REAR GLASS<sup>3</sup>

\$1,400

SPRINKLER PREP<sup>4</sup>

\$830

SEISMIC KIT<sup>5</sup>

\$1,900

REPLACEMENT COVER TRIMS SET

\$1,900

REPLACEMENT SIDES SET HPL

\$1,900

REPLACEMENT SIDES SET VENEERED

\$3,600

REPLACEMENT SIDES SET TEXTILE POD CS

\$7,206

**1. SELF-CLOSING HINGES** - Available in anodized aluminum and black finishing.

**2. FROSTED FILM ON REAR GLASS** - Frosted film between glasses.

**3. FROSTED FILM ON REAR GLASS** - Frosted film on glass (inside or outside). The exterior privacy film is prone to scratches.

**4. SPRINKLER PREP** - Knockout with a tube inside the ceiling module for housing a sprinkler. Does not include a sprinkler. Sprinkler needs to be installed by a certified company.

**5. SEISMIC KIT** - Brackets to mount the floor module to the existing floor with anchor bolts.

# FURNITURE OVERVIEW | silen

U & L-SHAPED COUCHES



## MODEL + DESCRIPTION

## PRICE

U-SHAPE SOFA FOR SPACE MAX<sup>1</sup>

\$10,900

L-SHAPE SOFA FOR SPACE MAX<sup>2</sup>

\$8,000

HIGH-BACK SOFA (1 UNIT)<sup>3</sup>

\$2,800

LOW-BACK SOFA (1 UNIT)<sup>4</sup>

\$2,000

STOOL WITH SWIVEL FUNCTION<sup>5</sup>

\$715

INTEGRATED STOOL (FIXED TO FLOOR)<sup>6</sup>

\$955

**1. U-SHAPED SOFA** - Pricing includes standard fabrics.

**2. L-SHAPED SOFA** - Pricing includes standard fabrics.

**3. HIGH-BACK SOFA** - **LENGTH:** 44.5" **HEIGHT:** 50.3" **DEPTH:** 24.4" **SOFA FABRIC COLOR:** Black, Dark Gray, Light Gray . Other colors available upon request. Custom colors for additional cost. Longer lead time may apply. **FABRIC:** POD CS. Antibacterial & other fabrics available upon request.

**4. LOW-BACK SOFA** - **HEIGHT:** 44.5" **DEPTH:** 24.4" **FABRIC STANDARD:** Black, Dark Gray, Light Gray. Other colors available upon request. Custom colors for additional cost. Longer lead time may apply. **FABRIC:** POD CS. Antibacterial & other fabrics available upon request.

**5. STOOL WITH SWIVEL FUNCTION** - **FRAME COLOR:** Black, Red, Gray **MATERIAL:** Metal **STOOL TURNS:** 360 Degrees **HEIGHT:** 29.9" **WEIGHT:** 22 lb

**6. INTEGRATED STOOL (FIXED TO FLOOR)** - **DIAMETER:** 13.8" **HEIGHT:** Min 22", Max 32.3" **ADJUSTABLE LEG:** Black with chrome bottom tube. **SEAT FABRIC:** Dark Gray - POD CS Col.9281 Antracit. Other colors available upon request. Custom colors for additional cost. Longer lead time may apply.

# FURNITURE OVERVIEW | silen

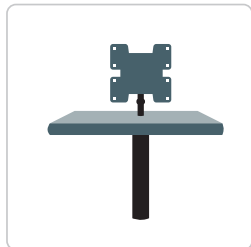
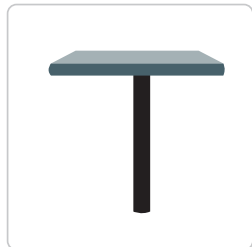

INTEGRATED  
MEETING  
TABLE FOR  
SPACE MAX<sup>5</sup>

## MODEL + DESCRIPTION

## PRICE

HEIGHT ADJUSTABLE TABLE<sup>1</sup>

\$2,500

INTEGRATED CENTER TABLE FOR S2<sup>2</sup>

\$1,200

INTEGRATED CENTER TABLE WITH SWIVEL SCREEN MOUNT<sup>3</sup>

\$3,500

INTEGRATED CENTER TABLE FOR S4<sup>4</sup>

\$1,800

INTEGRATED MEETING TABLE FOR SPACE MAX<sup>5</sup>

\$4,800

**1. HEIGHT ADJUSTABLE TABLE** - Lifting mechanism located inside the wall module. **TABLETOP:** White (antibacterial) laminated MDF **TABLETOP DIMENSIONS:** 26.6" x 10.7" **HEIGHT:** Min 27.6", Max 45.3"

**2. INTEGRATED CENTER TABLE FOR S2** - Integrated table without power outlet options (outlets only in the floor module) with metal base hidden under carpet. **TABLETOP DIMENSIONS:** 23.6" x 29.1" **HEIGHT:** 28.7" **TABLETOP:** White (antibacterial) laminated MDF **TABLE LEG:** Black

**3. INTEGRATED CENTER TABLE WITH SWIVEL SCREEN MOUNT** - Universal bracket for 27" screen. Screen not included. VESA 100x100 and 200x200 mounting. Available only with integrated table. Cable tray under the table Includes power outlet under the table. (2 x 230V +1 x USB-A+1 x USB-C)

**4. INTEGRATED CENTER TABLE FOR S4** - Fixed to floor center of pod. **TABLETOP:** White (antibacterial) laminated MDF **TABLE LEG:** Black **HEIGHT:** Min 27" **TABLETOP DIMENSIONS:** 63" x 29.1"

**5. INTEGRATED MEETING TABLE FOR SPACE MAX** - Wall mounted meeting table. White laminate. Includes surface cut-out for power storage includes cable tray.



# FURNITURE OVERVIEW | silen

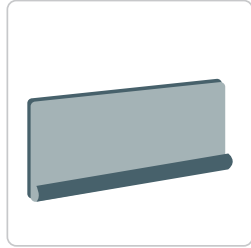

## MODEL + DESCRIPTION

## PRICE

INTEGRATED STORAGE UNIT FOR SILEN 2 AND SPACE MAX

\$7,000

ADDITIONAL POWER OUTLET<sup>1</sup>

\$1,180

POWER OUTLET UNDER SOFA (1 X 230V / USB A/C)

\$1,200

RETRACTABLE COAT/BAG HOOK<sup>2</sup>

\$300

MAGNETIC ERASER & PHONE/TABLET HOLDER<sup>3</sup>

\$280

**1. ADDITIONAL POWER OUTLET** - Additional power outlet under the table. 2 x 230V + 1 x USB-A + 1 x USB-C. Cables routed through the leg.

**1. RETRACTABLE COAT/BAG HOOK** - Black or white with plywood edge.

**1. MAGNETIC ERASER & PHONE/TABLET HOLDER** - Black or white with plywood edge.



**SILEN HYBRID**

# SILEN SPACE WORKSTATION HYBRID | silen

**A | STANDARD BASE MODEL:** The perfect getaway in an open office. This pod is the smallest of the Hybrid range, fitting one person inside. Silen Space WS Hybrid with an electrically height-adjustable table provides anyone the opportunity to work in silence.

**EXTERIOR:** (W x H x D) 94" x 89" x 48"

**INTERIOR:** (W x H x D) 87" x 85" x 43"

**PRODUCT WEIGHT:** 1433 lb

**PACKED WOODEN CRATE 1:** 36" x 95" x 57"

**TOTAL WEIGHT:** 1720 lb

## MODEL + DESCRIPTION

---

BASE MODEL

---

**A**

---

\$25,000

---



# SILEN SPACE WORKSTATION HYBRID | silen

MODEL + DESCRIPTION	STANDARD
LAMINATED SAFETY GLASS <sup>1</sup>	•
EXTERIOR FINISHES <sup>2</sup>	•
INTERIOR FINISHES <sup>3</sup>	•
DOOR FITTING & DOOR FRAME FINISHES <sup>4</sup>	•
FLOOR CARPET <sup>5</sup>	•
DOOR HANDLE SIDE <sup>6</sup>	•
ELECTRICAL CONNECTIONS <sup>7</sup>	•
INTEGRATED AIR CIRCULATION SYSTEM	•
LED LIGHT WITH PRESENCE SENSOR	•
ADJUSTABLE GLIDES <sup>8</sup>	•

**1. LAMINATED SAFETY GLASS** - 66.2 Sound control Rw 40 dB

**2. EXTERIOR FINISHES** - Silen Dynamics finishing options..

**3. INTERIOR FINISHES** - 3 Standard colors.

**4. DOOR FITTING & DOOR FRAME FINISHES** - 3 Standard colors.

**5. FLOOR CARPET** - 3 Standard colors.

**6. DOOR HANDLE SIDE** - Right-Handed or Left-Handed.

**7. ELECTRICAL CONNECTIONS** - 110-240 V (10 A) + 2 x USB (5 A).

**8. ADJUSTABLE GLIDES** - For easy leveling.

# WS HYBRID ACCESSORIES | silen



## MODEL + DESCRIPTION

## PRICE

AUTOMATIC DOOR

\$8,000

ELECTRIC HEIGHT ADJUSTABLE TABLE<sup>1</sup>

\$3,000

POWER SOCKET ON THE TABLETOP

\$1,175

ANTIBACTERIAL HANDLE

\$215

CUSTOM COLOR LAMINATE

\$1,400

VENEER EXTERIOR

\$2,100

TEXTILE SIDES (POD CS)

\$2,000

AIR FLOW AND LIGHTING DIMMER

\$888

**1. ELECTRIC HEIGHT ADJUSTABLE TABLE** - Electrically adjustable table with buttons on the edge of the table top. **TABLE TOP DIMENSIONS:** 43.3" X 21.7" **HEIGHT ADJUSTMENTS:** min 27.6 in, max 45.3 in **TABLE TOP:** white or black Fenix NTM (antibacterial) with plywood edge MDF **LEG:** Black. With integrated power outlet on the wall.

# WS HYBRID ACCESSORIES | silen



## MODEL + DESCRIPTION

## PRICE

OCCUPANCY INDICATOR

CALL

FROSTED FILM ON REAR GLASS<sup>1</sup>

\$955

FROSTED FILM ON REAR GLASS<sup>2</sup>

\$955

REPLACEMENT COVER TRIMS SET

\$1,800

REPLACEMENT SIDES SET HPL

\$1,400

REPLACEMENT SIDES SET VENEERED

\$1,600

REPLACEMENT SIDES SET TEXTILE POD CS

\$2,100

**1. FROSTED FILM ON REAR GLASS** - Frosted film between glasses.

**2. FROSTED FILM ON REAR GLASS** - Frosted film on glass (inside or outside). The exterior privacy film is prone to scratches.

# SILEN SPACE 2 HYBRID | silen

**A | STANDARD BASE MODEL:** The place to meet. This pod gives everyone an opportunity to work together, share ideas, and have private discussions. Silen Space 2 Hybrid can be used by 2 wheelchair users, otherwise fits up to 4.

**EXTERIOR:** (W x H x D) 94" x 89" x 48"

**INTERIOR:** (W x H x D) 87" x 85" x 43"

**PRODUCT WEIGHT:** 1433 lb

**PACKED WOODEN CRATE 1:** 36" x 95" x 57"

**TOTAL WEIGHT:** 1720 lb

## MODEL + DESCRIPTION

---

BASE MODEL

---

**A**

---

\$35,000

---



# SILEN SPACE 2 HYBRID | silen

MODEL + DESCRIPTION	STANDARD
LAMINATED SAFETY GLASS <sup>1</sup>	•
EXTERIOR FINISHES <sup>2</sup>	•
INTERIOR FINISHES <sup>3</sup>	•
DOOR FITTING & DOOR FRAME FINISHES <sup>4</sup>	•
FLOOR CARPET <sup>5</sup>	•
DOOR HANDLE SIDE <sup>6</sup>	•
ELECTRICAL CONNECTIONS <sup>7</sup>	•
INTEGRATED AIR CIRCULATION SYSTEM	•
LED LIGHT WITH PRESENCE SENSOR	•
ADJUSTABLE GLIDES <sup>8</sup>	•
POSSIBLE TO COMBINE TWO SPACE 2 HYBRID ROOMS INTO A SPACE 4 HYBRID	•

**1. LAMINATED SAFETY GLASS** - 66.2 Sound control Rw 40 dB

**2. EXTERIOR FINISHES** - Silen Dynamics finishing options..

**3. INTERIOR FINISHES** - 3 Standard colors.

**4. DOOR FITTING & DOOR FRAME FINISHES** - 3 Standard colors.

**5. FLOOR CARPET** - 3 Standard colors.

**6. DOOR HANDLE SIDE** - Right-Handed or Left-Handed.

**7. ELECTRICAL CONNECTIONS** - 110-240 V (10 A) + 2 x USB (5 A).

**8. ADJUSTABLE GLIDES** - For easy leveling.



# SILEN SPACE 2 HYBRID ACCESSORIES | silen

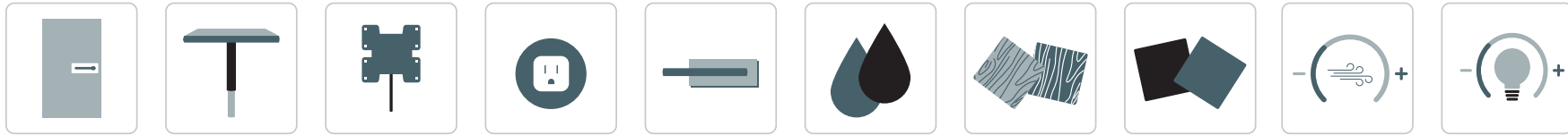

## MODEL + DESCRIPTION

## PRICE

AUTOMATIC DOOR

\$8,000

FOLDABLE TABLE WITH GAS-SPRING & POWER SOCKET<sup>1</sup>

\$3,800

FOLDABLE JUMP SEAT

\$3,000

SCREEN BRACKET ON GLASS

\$1,200

ANTIBACTERIAL HANDLE

\$215

CUSTOM COLOR LAMINATE

\$1,500

VENEER EXTERIOR

\$2,400

TEXTILE SIDES (POD CS)

\$2,200

AIR FLOW AND LIGHTING DIMMER

\$888

**1. FOLDABLE TABLE WITH GAS-SPRING & POWER SOCKET - TABLE TOP DIMENSIONS:**29.1" X 22.8" **TABLE TOP:** White or Black Fenix NTM (antibacterial) with plywood edge MDF **LEG:** Black. With integrated power outlet inside leg column.

# SILEN SPACE 2 HYBRID ACCESSORIES | silen



## MODEL + DESCRIPTION

## PRICE

OCCUPANCY INDICATOR

CALL

FROSTED FILM ON REAR GLASS<sup>1</sup>

\$955

FROSTED FILM ON REAR GLASS<sup>2</sup>

\$955

REPLACEMENT COVER TRIMS SET

\$1,700

REPLACEMENT SIDES SET HPL

\$1,700

REPLACEMENT SIDES SET VENEERED

\$2,000

REPLACEMENT SIDES SET TEXTILE POD CS

\$2,800

EXTENSION MODULE<sup>3</sup>

\$33,000

CONNECTION KIT<sup>4</sup>

\$1,300

**1. FROSTED FILM ON REAR GLASS** - Frosted film between glasses.

**2. FROSTED FILM ON REAR GLASS** - Frosted film on glass (inside or outside). The exterior privacy film is prone to scratches.

**3. EXTENSION MODULE** - An extension module to create Space 6 with existing Space 4. Without glasses and covering trims.

**4. CONNECTION KIT** - A kit to connect Space 4 into one Space 6 with extension module. Includes connections.

# SILEN SPACE 4 HYBRID | silen

**A | STANDARD BASE MODEL - ADA/EAA-COMPLIANT:** Everyone can join. Silence Space 4 Hybrid allows others to join in on the conversation and have a bigger meeting. This pod fits up to 4 wheelchair users, otherwise up to 8 side-by-side.

**EXTERIOR:** (W x H x D) 94" x 89" x 98"

**INTERIOR:** (W x H x D) 87" x 85" x 90"

**PRODUCT WEIGHT:** 2513 lb

**PACKED WOODEN CRATE 1:** 36" x 95" x 57"

**TOTAL WEIGHT:** 3086 lb

## MODEL + DESCRIPTION

---

BASE MODEL

---

**A**

---

\$62,000

---



# SILEN SPACE 4 HYBRID | silen

MODEL + DESCRIPTION	STANDARD
LAMINATED SAFETY GLASS <sup>1</sup>	•
EXTERIOR FINISHES <sup>2</sup>	•
INTERIOR FINISHES <sup>3</sup>	•
DOOR FITTING & DOOR FRAME FINISHES <sup>4</sup>	•
FLOOR CARPET <sup>5</sup>	•
DOOR HANDLE SIDE <sup>6</sup>	•
ELECTRICAL CONNECTIONS <sup>7</sup>	•
INTEGRATED AIR CIRCULATION SYSTEM	•
LED LIGHT WITH PRESENCE SENSOR	•
ADJUSTABLE GLIDES <sup>8</sup>	•
POSSIBLE TO SPLIT A SPACE 4 HYBRID INTO TWO SPACE 2 ROOMS	•

**1. LAMINATED SAFETY GLASS** - 66.2 Sound control Rw 40 dB

**2. EXTERIOR FINISHES** - Silen Dynamics finishing options..

**3. INTERIOR FINISHES** - 3 Standard colors.

**4. DOOR FITTING & DOOR FRAME FINISHES** - 3 Standard colors.

**5. FLOOR CARPET** - 3 Standard colors.

**6. DOOR HANDLE SIDE** - Right-Handed or Left-Handed.

**7. ELECTRICAL CONNECTIONS** - 110-240 V (10 A) + 2 x USB (5 A).

**8. ADJUSTABLE GLIDES** - For easy leveling.

# SILEN SPACE 4 HYBRID ACCESSORIES | silen



MODEL + DESCRIPTION	PRICE
AUTOMATIC DOOR	\$8,000
FOLDABLE TABLE WITH GAS-SPRING & POWER SOCKET <sup>1</sup>	\$3,800
FOLDABLE JUMP SEAT	\$3,000
SCREEN BRACKET ON GLASS	\$1,200
ANTIBACTERIAL HANDLE	\$215
CUSTOM COLOR LAMINATE	\$3,000
VENEER EXTERIOR	\$4,000
TEXTILE SIDES (POD CS)	\$3,600

<sup>1</sup> **FOLDABLE TABLE WITH GAS-SPRING & POWER SOCKET** - **TABLE TOP DIMENSIONS:** 29.1" X 22.8" **TABLE TOP:** White or Black Fenix NTM (antibacterial) with plywood edge MDF **LEG:** Black. With integrated power outlet inside leg column.

# SILEN SPACE 4 HYBRID ACCESSORIES | silen



MODEL + DESCRIPTION	PRICE
AIR FLOW AND LIGHTING DIMMER	\$888
OCCUPANCY INDICATOR	CALL
FROSTED FILM ON REAR GLASS <sup>1</sup>	\$955
FROSTED FILM ON REAR GLASS <sup>2</sup>	\$955
REPLACEMENT COVER TRIMS SET	\$1,700
REPLACEMENT SIDES SET HPL	\$2,000
REPLACEMENT SIDES SET VENEERED	\$4,000
REPLACEMENT SIDES SET TEXTILE POD CS	\$3,600
SEPARATION KIT <sup>3</sup>	\$9,800

**1. FROSTED FILM ON REAR GLASS** - Frosted film between glasses.

**2. FROSTED FILM ON REAR GLASS** - Frosted film on glass (inside or outside). The exterior privacy film is prone to scratches.

**3. SEPARATION KIT** - A kit to split Space 4 room into two Space 2 rooms. Includes front and back glass set, door and a set of covering trims.