



**MATRIX**  
**GROUP**  
**TRAINING**  
BROCHURE



# CONTENTS

## **4 MATRIX FITNESS**

TOTAL SOLUTIONS PARTNER  
STRONG. SMART. BEAUTIFUL.™  
GROUP TRAINING OVERVIEW

## **10 CONNECTED SOLUTIONS**

CONNECTED SOLUTIONS: TARGET TRAINING

## **16 SPRINT 8® GX**

PROGRAMMING

## **22 TRAINING CYCLES**

CXP TARGET TRAINING CYCLE  
CXM TRAINING CYCLE  
CXC TRAINING CYCLE  
PROGRAMMING

## **32 S-DRIVE™ PERFORMANCE TRAINERS**

TRAINING SUPPORT  
S-DRIVE POWER  
S-DRIVE METRICS  
S-DRIVE

## **40 S-FORCE™ PERFORMANCE TRAINERS**

TRAINING SUPPORT

## **44 ROWERS**

TRAINING SUPPORT  
RXP ROWER  
ROWER

## **50 GROUP TRAINING LED CONSOLE**

## **54 CONNEXUS™**

TRAINING SUPPORT  
CONNEXUS PERIMETER  
CONNEXUS PERIMETER EXPANSION KIT  
CONNEXUS FREE  
CONNEXUS COMPACT  
CONNEXUS COLUMN  
CONNEXUS STEP+  
CONNEXUS STORAGE STATION  
CONNEXUS STORAGE CARTS

## **68 MX4™ TRAINING SYSTEM**

PROGRAMMING

# GET MORE THAN THE WORLD'S FINEST FITNESS EQUIPMENT

**When you choose Matrix, you're getting more than the world's finest fitness equipment. You're getting a partner that will be there, for your grand opening and every day after. Together, there's no detail of your business that we can't refine, reimagine or reinvent. And that includes your bottom line.**

## **FACILITY PLANNING**

Your space. Your goals. Your budget. We'll help bring your fitness center to life from your earliest ideas to the day you open your doors.

## **POST-INSTALL PRODUCT TRAINING**

We'll give your team a full demonstration on how to use your new equipment, plus introduce exclusive programs like Sprint 8®. At the end of training, your team will have everything they need to show members how to use your new equipment to its fullest potential.

## **INDUSTRY-LEADING WARRANTIES**

Our promise of quality to you. We offer all of the protection you need to choose confidently and know that you've chosen the products with the lowest cost of ownership in the industry.

## **DEDICATED SALES SUPPORT**

Our internal teams will work with you to help you reach your unique goals. We'll help you choose the ideal mix of products for your needs and work with you to update and expand as your needs change.

## **FINANCING**

We won't let monetary roadblocks get in the way of you providing a premium experience that meets the needs of the people you serve. Our dedicated staff will work with you to design a financing package that expands your options and maximizes your investments.

## **UNMATCHED CUSTOMER SUPPORT**

A 98% first-time fix rate. A 90% live answer rate in two minutes or less. A 48-hour service response window. More than 350 service providers with over 800 technicians to serve you. And with our amazing console technology, we can provide diagnostic services remotely or on site.

## **MATRIX LEARNING**

Product training. Maintenance tips. Career building. On-demand educational videos. A whole new world of service and support. It's all at your fingertips with Matrix Learning ([matrixlearningcenter.com](http://matrixlearningcenter.com)).

## **TOTAL MARKETING SUPPORT KIT**

You want to let clients know about the exciting programs and products that make your facility different, and we want to help. Ask us about customized promotional materials to help you reach and retain clients like never before.

## **SUSTAINABILITY**

We are committed to being a responsible global citizen when comes to not only our planet, but also our people and our practices. Everything Matrix is intentional: accessible employee wellness programs, reduced water consumption, strategic warehouse locations and more.

## **DISTRIBUTION NETWORK**

Five distribution centers. Five ports of entry. 800,000 square feet of warehouse space. We have invested heavily in distribution and logistics resources to provide geographically close and immediate service to you. Strategic partnerships with experienced installation, logistics and warehouse agencies allow us to be more efficient and responsive to customer needs, remedying issues quickly, and mitigating risk.

## **CUSTOM BRANDING**

Choose from frame and upholstery options that match your brand and showcase your logo in a variety of placement options. You can even count on us for next-level customization like branded console screens, premium embroidery, laser-cut steel and more.

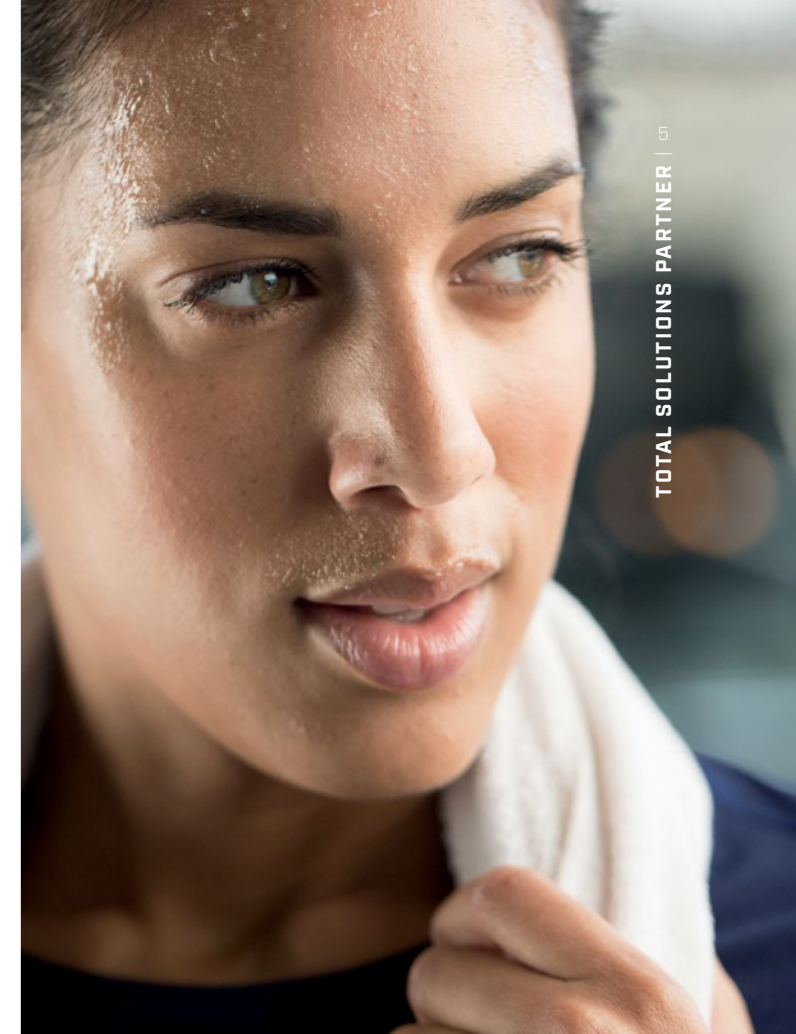



## STRONG. SMART. BEAUTIFUL.™

**It's more than a tagline. It's our holistic promise to you that these three qualities will shine through all the group training that hits your floor and define our ongoing partnership.**

### **STRONG**

Designed to withstand the hard use in group training environments, our equipment is just as strong as our commitment to being your partner, not just your supplier. This strength gives us a solid foundation for success, today and in the future, and has made us one of the world's premier group training brands.

### **SMART**

We listen and create group training equipment with a purpose in mind — to address your needs and resolve them in ingenious ways. From designs that optimize your space to the movement versatility of our S-Drive™ to the motivating metrics of our Target Training Display, our forward-thinking solutions redefine group training, for both you and your members.

### **BEAUTIFUL**

Our group training equipment attract beginners and fitness enthusiasts alike. Each piece is intuitive and approachable so members can get started without wasting a moment of valuable workout time. Our group training equipment continues to set new industry standards through award-winning aesthetic distinction and incredible attention to detail.

## GROUP TRAINING OVERVIEW

# A BETTER WAY TO GET FIT: TOGETHER

**Group Training participation continues to increase and provides a significant reason for users to visit fitness facilities. The popularity and demand for Group Training solutions continues to increase as consumers realize the special value they placed on the motivation, camaraderie and accountability that comes from attending group sessions. As Group Training participants are consistently the most loyal and highest net score promoters our turnkey solutions offer you an integrated approach to this ever evolving and growing industry segment.**

### CARDIO

Signature cardio programs are the foundation of group training, and we offer options that can appeal to members of all kinds. Challenge your members with the versatile intensity of our user-driven S-Drive™ and S-Force™ Performance Trainers. Add our rower to your circuit training program for low-impact cardio that strengthens the whole body. You can even create an advanced, accessible group cycling experience with our exciting new Training Cycles.

### FUNCTIONAL STRENGTH

For group training solutions focused on strength and flexibility, our distinctive offering will give enthusiasts the kind of dynamic exercise experience they won't find anywhere else. Our Connexus™ Functional Training System is nothing short of essential for classes where users perform weight-bearing exercises that reflect their daily activities. The smart, modular design of our Connexus collection offers flexibility and expandability, making it easy to transform underused spaces into functional training zones and expand your offering as interest in functional training continues to grow.



MATRIX CONNECTED SOLUTIONS

## GET CONNECTED TO A WORLD OF DIGITAL SOLUTIONS

**You want to deliver an unmatched fitness experience, and Matrix Connected Solutions gives you the flexible tools you need to do it your way, regardless of the size of your facility or budget.**

With the power of our robust, open platform at your fingertips, service and maintenance become hassle-free. Your trainers can connect and engage with members in new ways for better results and more referrals. Everyone who comes through your doors can instantly enjoy their favorite music, entertainment and social networks on connected cardio platforms. By adding our Target Training Display to select equipment, you can offer a range of diverse exercise experiences that motivate members with personalized metric goals. And that's just a taste of what Matrix Connected Solutions can do.

Discover how our complete selection of hardware and software solutions can help bring your vision of fitness to life in bigger, bolder, brighter ways than ever before.

**Discover more at [matrixconnectedsolutions.com](https://matrixconnectedsolutions.com)**



MATRIX TARGET TRAINING

## MOTIVATING. MEASURABLE. AND GOAL-BASED.

Whether you're all about Group X, superior circuits or pushing athletes to shatter their limits, you can motivate your people like never before with personalized, goal-based target training workouts that track heart rate, watts, distance, calories or speed. Depending on your facility and the people you serve, choose the CXP Target Training Cycle, S-Drive™ Power or RXP Rower. All can be used in group environments or for personal workout programs that leverage Sprint 8® programming, interval training and more. There's nothing like target training, and it's only available from Matrix.

### EFFORT GUIDED BY COLOR

The Target Training Display's LED wrap lights up with three intuitive colors to express effort relative to personalized metrics: blue, for below the target range for the metric; green, for on track to hit the metric target; and red, for exertion that will surpass the metric target. Instructors can easily guide members of different ability levels through their workout, all while tracking effort and keeping them on pace for their unique goals.

### COMPLETE CONNECTIVITY

ANT+, Bluetooth and WiFi connectivity enable you to take full advantage of some of our most powerful Connected Solutions. This means that while your members are busy transforming their physiques, you'll be transforming the way you do business.



### CXP TARGET TRAINING CYCLE

Our CXP Target Training Cycle makes it easy to lead a next-level cycling class that holds a wide range of members accountable to personalized goals. Sessions that focus on different metrics keep classes fresh and help members see measurable progress with every pedal stroke. A sub-max heart rate test and eight- and 20-minute FTP tests make sure everyone is riding at a level right for their abilities. // See page 26

### S-DRIVE POWER PERFORMANCE TRAINER

Our S-Drive Power helps athletes and coaches maximize sport-specific speed and explosiveness using advanced metrics. A sub-max heart rate test helps athletes define their limits and shatter them in exciting new ways. // See page 36

### RXP ROWER

Our RXP Rower can elevate rowing classes with metrics that matter or create metric-driven circuits that keep the training experience fresh. A sub-max heart rate test, a step power test and 500- and 2,000-meter splits help each rower find a level of challenge ideal for their personal fitness. // See page 48



# CONNECTED SOLUTIONS

## COMMUNITY 360

### BRING IT ALL TOGETHER UNDER YOUR BRAND

Our ingenious Community 360 lets members capture data from all their favorite fitness apps and all the ways they work out in one place using a single customizable interface that puts your facility at the center of their fit lifestyle. Members can easily create personalized strength training goals, compete in challenges and applaud others through activity-based social feeds, and you can motivate members by offering reward points for check-ins, personal training, purchases and even personal bests.

## ASSET MANAGEMENT™

### KEEPING AN EYE ON YOUR EQUIPMENT SO YOU DON'T HAVE TO

Our industry-leading Asset Management platform offers a 360-degree view of your equipment on virtually any internet-connected device. Easy-to-read color-coding tells you whether a product is functioning properly, detects errors and alerts you if something is offline. Whether you manage one facility or many, the system can create customized reports to help maximize product life and identify the optimum product mix. It also improves Communication with Matrix and your service provider, streamlining maintenance and repair while reducing paperwork and hassle. The customization interface even provides an array of smart marketing tools to help you get more members into your facility.



## RFID

### STREAMLINE YOUR MEMBERS' EXERCISE EXPERIENCE

RFID is a smart way to streamline your members' training experience. Simple radio-frequency tags make check-in, program loading and workout tracking completely touch-free and virtually automatic. Members can even use RFID with your existing RFID-compatible vending machines, kiosks and in-facility sales centers for quick impulse buys of your branded merchandise, snacks, beverages and more.

## ANT+

### SEND DATA TO THE BIG SCREEN TO SPARK COMPETITION IN THE STUDIO

The ANT+ broadcast feature on the CXM training cycle and CXP target training cycle enables facilities to send data to external leaderboards, so all user performance data is on display in real time to drive competition and spur performance.

## BLE FTMS

### SEND DATA TO SMART PHONE APPS FOR PERSONAL PERFORMANCE TRACKING IN THE STUDIO

The BLE FTMS broadcast feature enables the CXM training cycle and CXP target training cycles to pair with popular smart phone apps for personal performance tracking to measure changes in performance over time.





SPRINT 8® GX

**INSPIRING. INTENSE. AND UNLIKE ANYTHING ELSE.**

Only Sprint 8 GX combines sprint intensity cardio and strength training with turnkey programming for a uniquely inspiring, instructor-led experience. Best of all, it can be done on a range of equipment and by members of all kinds.

**SPRINT 8 GX**

A woman in a grey tank top is running on a Matrix treadmill in a gym. In the background, another woman in a yellow tank top is talking to a group of people. The scene is set in a bright, modern gym with large windows.

# SPRINT 8<sup>®</sup> GX

SPRINT 8 GX

Sprint 8 GX is different, created to redefine your group training offering in ways that deliver results for you and your members. Only Sprint 8 GX combines sprint intensity cardio and a uniquely effective strength training component with flexible turnkey programming for an inspiring, instructor-led exercise experience unlike anything else. Sprint 8 GX was designed with your needs in mind, so you can offer it on your cardio floor or in a special training area in your facility. Best of all, the intensity of Sprint 8 GX is based on the abilities of the member, so both elite athletes and those just beginning their fitness journey will experience a challenging and rewarding workout.

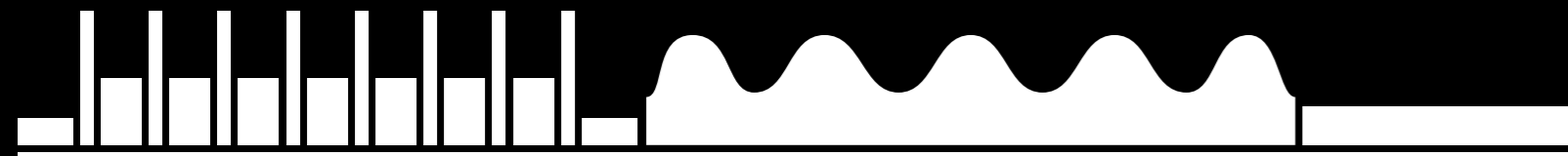

## LEARN FROM CERTIFIED MASTER TRAINERS\*

Certified Matrix Master Trainers will come to your facility to teach you and your trainers everything you need to help participants build muscle, strengthen bones, enhance cardiovascular health and trigger active-aging benefits in each session.

## POWERED BY MATRIX-EXCLUSIVE EQUIPMENT

Sprint 8 GX can be completed on a range of Matrix cardio platforms and consoles. So, whether your participants like to run, ride, climb or row, Sprint 8 will be available at the touch of a button.

## FULL BUSINESS SUPPORT

We'll be there every step of the way to make sure your facility is ready to launch Sprint 8 GX. Our education team will work with you to define optimal business model, pricing structure and the turnkey marketing package to ensure your program is a success.

## PROGRAMMING AT YOUR FINGERTIPS

Available through the Matrix Group Education Platform, trainers have complete access to all their Sprint 8 GX programming, all in one place. From educational content to certificates to resources, trainers have instant access to everything they need to run Sprint 8 GX classes.





## SPRINT 8 GX

### SPRINT 8<sup>®</sup> GX GROUP TRAINING COURSE

Sprint 8 GX Group Training Course is a workshop that teaches trainers and coaches how to run a successful, community-building program that builds muscle, strengthens bones, enhances cardiovascular health and triggers active-aging benefits in each session. Using Matrix cardiovascular products with embedded Sprint 8 sprint-intensity program and unique strength and conditioning movements, course participants will learn everything they need to create an inclusive, results oriented program that's unlike anything else.

### COURSE INCLUDES

- Instruction on how to run a successful 45-minute group training program on the cardio floor
- Education about the science and benefits of sprint-intensity training
- Essential direction for setting up and coaching group training classes effectively
- Ways to manage and recognize the psychological and physiological response of the exercise paradox to maximize results and optimize training time
- Learn how to incorporate a range of cardio modalities in a single session including treadmills, Ascent trainer, ellipticals, stationary cycles, rowers, indoor cycles and S-Drive™ and S-Force™ Performance Trainers
- Access to an online exercise library demonstrating 25 explosive and flexibility exercises.
- Turnkey workouts with built-in progression for a wide variety of participants.

### SPRINT 8 GX ACCREDITATIONS

ACE (0.6 CEUs), AFAA (6 CEUs), NASM (0.6 CEUs), NSCA (0.6 CEUs), ACSM (6 CEUs), CanFitPro (4 CEUs)

TRAINING CYCLES

**PRECISION ENGINEERED  
FOR A SUPERIOR CYCLING EXPERIENCE**

Our Training Cycles give you everything you need to attract more riders and make your group cycling classes a core part of their training regimen.

**TRAINING CYCLES**



# TRAINING CYCLES

All of our durable Training Cycles feature optimized ergonomics and intuitive adjustments that make it hassle-free for every member — no matter what their body type or ability level — to experience the feel of a real outdoor ride.

## ADVANCED ERGONOMICS & ADJUSTMENTS

The detail-oriented design of our Training Cycles begins with a narrow Q-factor that optimizes the position of the hips, knees and feet to comfortably mimic a real outdoor riding experience. A magnetic system provides smooth resistance changes to help riders transition from one portion of the ride to the next, while intuitive four-way adjustment with quick-touch operation and easy seat tilt make customizing the cycle to each user's body virtually effortless.

## ENHANCED COMFORT & CONVENIENCE

All of our Training Cycles include an ergonomically sculpted seat to relieve pressure on touchpoints, making even long, intense cycling classes comfortable. A contoured lever near the handlebars provides tactile feedback for on-the-fly resistance changes, and multi-position handlebars with an integrated water bottle holder provide a comfortable grip while keeping hydration easily accessible.

## STREAMLINED SERVICE & SETUP

The low-maintenance, well-protected rear flywheel design of our cycles includes a quick-release service panel, easily removable pedal cranks and clearly identifiable internal components to make service a breeze for heavy-use facilities. Unlike traditional indoor cycles that require two wrenches to tighten or level the seat, our design requires only one Allen wrench to adjust the seat to the optimal position.



## CXP TARGET TRAINING CYCLE

The advanced CXP Target Training Cycle gives you everything you need to attract more riders and make your group cycling classes a core part of their training regimen. Our display is specifically engineered for target training — whether you're tracking watts, heart rate, RPMs, distance or calories — and includes a bright LED wrap that uses intuitive colors to tell the instructor and the rider if they are on track for their goals. Integrated programmable metrics help both instructors and riders make the most of every class, and a wide range of personal training programs offer plenty of ways for the enthusiast to train outside of class.

### FEATURES

- Within +/- 3% watts accuracy
- Quick-adjust pedals
- Integrated Sprint 8" program
- Integrated FTP testing and a sub-max heart rate test
- WiFi, ANT+ and BLE FTMS enabled

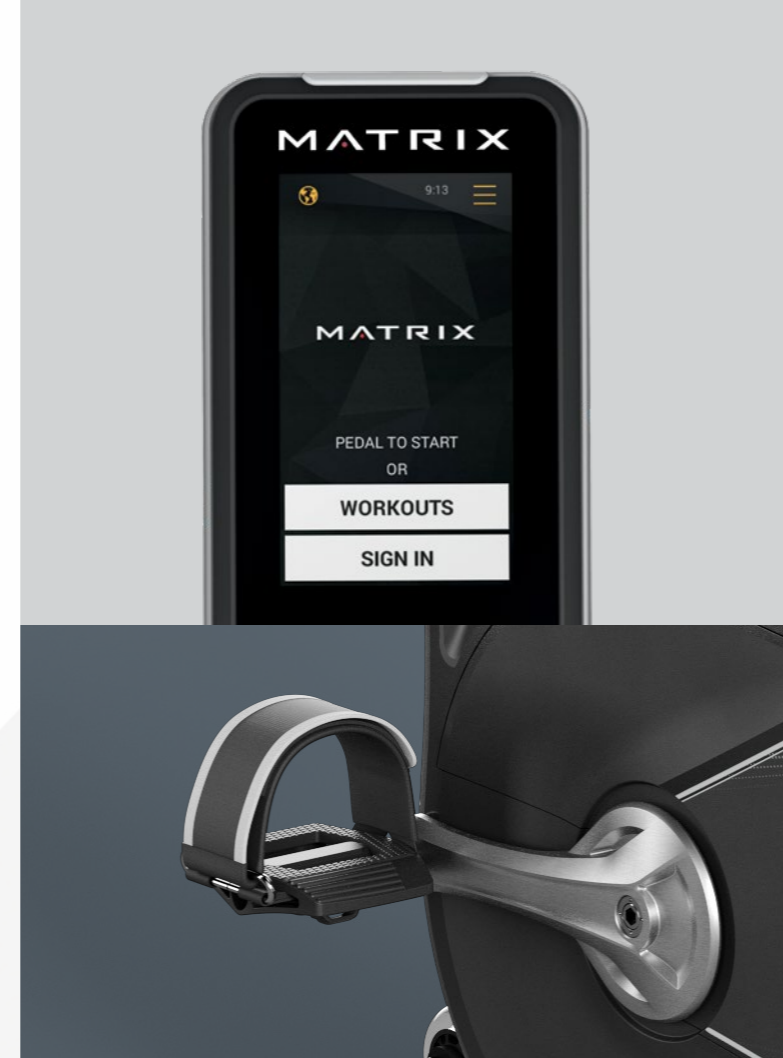

The CXP Target Training Cycle pairs the effectiveness of personalized training with the excitement and energy of group exercise by providing riders with individualized goals right for their ability level and fitness aspirations.



## CXM TRAINING CYCLE

Our CXM Training Cycle takes your group classes to the next level with clear metric tracking, quality performance and excellent ergonomics. The quick-response, backlit LCD console clearly displays all training metrics and provides the ability to bring extra focus to watts, heart rate, RPMs or custom intervals in a way that helps your riders chart their progress and get real results.

### FEATURES

- Watt measurement within +/- 10% accuracy
- ANT+ and BLE FTMS enabled



CXM TRAINING CYCLE



## CXC TRAINING CYCLE

Our CXC Training Cycle will make your group classes more popular than ever with performance that's as powerful as it is comfortable. A device storage shelf makes it easy for riders to keep their smartphone in view. Add the optional wireless LCD console for a basic metric-tracking experience that clearly displays RPMs, calories, distance, time and heart rate when used with a heart rate strap.



CXC TRAINING CYCLE | 29



Optional Computer

# MATRIX RIDE PROGRAMMING

**Matrix Ride® makes it easy for instructors to lead a next-level cycling class that engages a wider range of members. Our exclusive, all-original programming blends the energy of classic group cycling with precision performance training, integrating metrics like watts, heart rate, RPMs, distance and calories for compelling classes that deliver measurable results.**

## SUPPORTED BY US, OWNED BY YOU

Our turnkey package includes a workshop led by a Matrix Master Trainer including the comprehensive Matrix Ride manual, and a complete implementation guide to make your new cycling program a success. We'll also help you fill your classes by providing comprehensive marketing resources that let all your members know about this special offering. Best of all, the programming is owned by your facility in perpetuity.

## PROGRAMMING AT YOUR FINGERTIPS

Available through the Matrix Group Education Platform, instructors have complete access to all their Ride programming, all in one place. From educational content to certificates to resources, instructors have instant access to everything they need to create an industry-best cycling class.

\* Availability of Matrix Ride program varies by market



## CXP WORKSHOP

Created to maximize the potential of CXP Target Training Cycles, our programming package includes an eight-hour workshop, an educational manual, lesson plans and more, giving trainers everything they need to create an industry-best cycling class that sets your facility apart from others in powerful ways. Instructors will learn how to guide class participants through Target Training rides using each of the five individual metrics (watts, heart rate, RPMs, distance and calories), or even a combination of multiple metrics. They will learn how to set personalized targets using tools like the integrated FTP and sub-max heart rate testing, and how to use the LED color wrap to gauge effort and performance.

## CXP ACCREDITATIONS

ACE (0.7 CECs), AFAA (7 CEUs), NASM (0.7 CEUs), CanFitPro (4 CECs)

## CXM WORKSHOP

Choose our precision-engineered CXM Training Cycle, and you'll have the option to add a live, product-focused, six-hour education workshop delivered by one of our Master Trainers at your facility. Your instructors will learn how to get the most out of the cycle's premium design and metric-tracking LCD display, plus how to quickly set up, how to transition from one riding position to another, how to adjust the cycles to different body types and much more.

## CXM ACCREDITATIONS

ACE (0.4 CECs), AFAA (5 CEUs), NASM (0.5 CEUs)

## CYCLING BASICS WORKSHOP

This optional three-hour training session delivered by a Matrix Master Trainer covers the fundamentals of running a successful group cycling class using CXC cycles. Trainers will learn how to set up cycles properly, transition between riding positions and adjust the cycles to fit the needs of each individual rider.







S-DRIVE™ PERFORMANCE TRAINERS

**FOR SUPERIOR CIRCUITS, HIIT TRAINING & BEYOND**

Create the kind of circuit training program that attracts and retains members by adding a versatile, intense new modality.

*S-DRIVE*  
**PERFORMANCE TRAINERS**



# S-DRIVE™ PERFORMANCE TRAINERS

Our S-Drive Performance Trainers add an amazing new dimension to virtually any circuit training program. Versatile, space-saving design lets members take on power walking, running, HIIT, sled-pushing, parachute training and agility drills with magnetic resistance settings just right for their ability level and goals. Choose our S-Drive Power for a complete target training experience, the S-Drive Metrics for clear workout feedback or the original S-Drive Performance Trainer. All include a sled brake with eight repeatable resistance settings, parachute brake with 11 repeatable resistance settings, 7-degree incline, true zero start speed, unlimited top speed and a convenient 17.8 cm / 7" step-on height.

## SMALL & LARGE GROUP CIRCUITS

By incorporating the S-Drive in your group circuit training, there's no limit to the different ways your trainers and instructors can provide full-body workouts. For example, while one participant begins with a low-resistance, long-stride walk on the S-Drive, another can take on functional exercises like TRX chest presses, floor-based dumbbell exercises or core exercises. They would then switch, building cardiovascular, anaerobic and muscular endurance as they correct postural imbalances, improve coordination and enhance motor function. We provide nine-week protocols for both small group training (up to eight participants) and large group training (up to 12 participants).

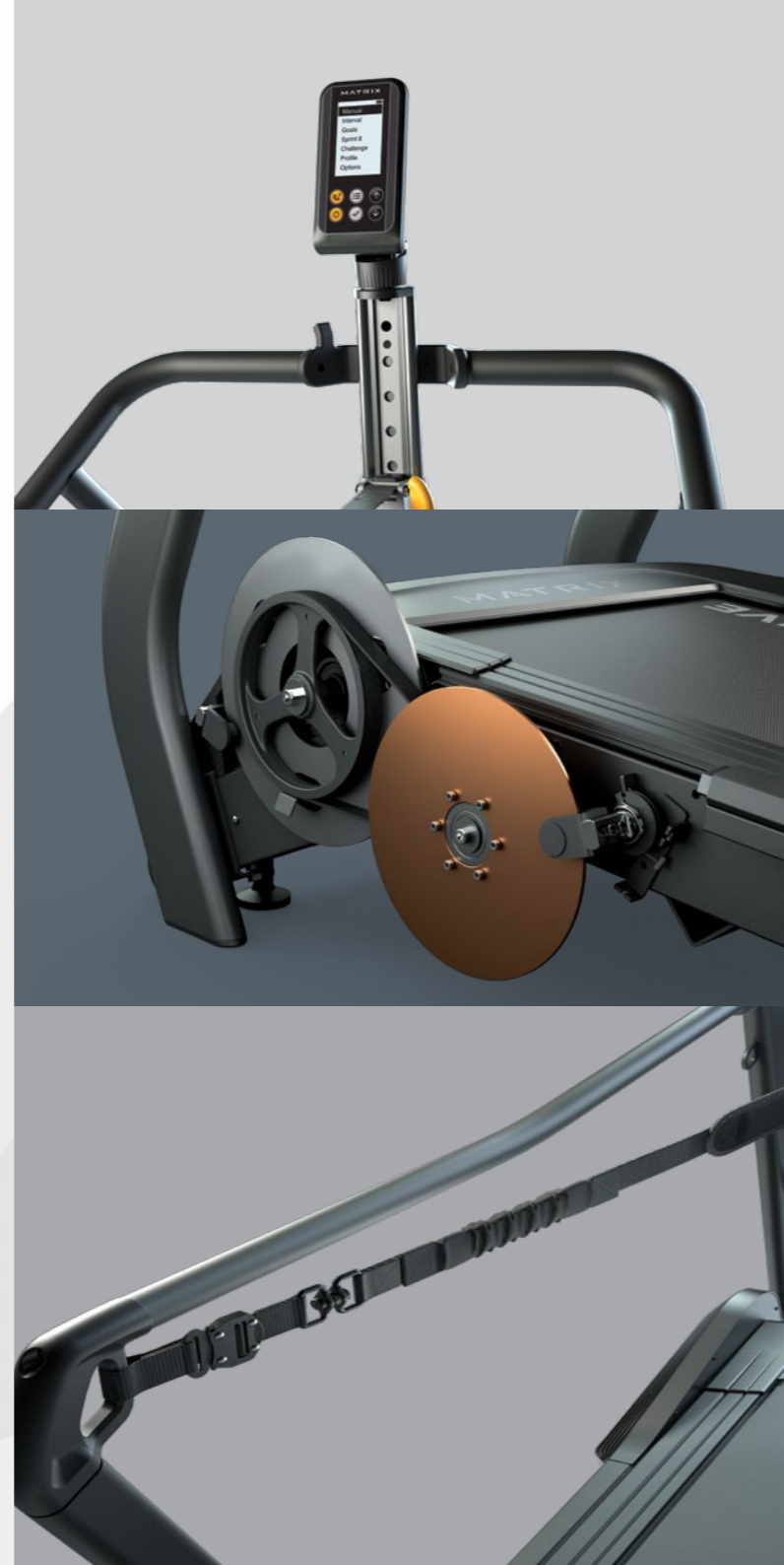

## SPORTS PERFORMANCE TRAINING

The S-Drive provides high-intensity training ideal for athletes striving to reach their maximum potential. With the ability to simulate sprinting, sled pushing and parachute training, the S-Drive can significantly enhance explosiveness and endurance. Athletes can also improve agility through a mix of forward, lateral and reverse movements. Count on our four-week S-Drive Sprint Training Protocol to improve speed, endurance, power and neuromuscular development.

## REHABILITATION & ACTIVE AGING

The S-Drive can provide significant benefits for users training to recover from an injury or older users striving to maintain functional health. Full perimeter handrails make entering and exiting easy and secure, a true zero starting speed accommodates users of all ability levels, and the user-driven design provides a more natural gait than treadmills.



## S-DRIVE™ POWER

The S-Drive Power adds a Target Training Display specifically engineered for goal-based training, making it easier than ever for members to take on sprints, sled pushes and parachute training with precision data tracking. Integrated testing establishes personalized targets just right for the ability level of each member, while the unique LED wrap helps trainers and members gauge intensity with bright colors. The display even pivots so trainers can easily view feedback. Whether tracking watts, speed, time, distance, heart rate or taking on high-intensity interval training, the personalized metrics help members maintain effort and reach their goals. Includes a built-in sled-push bar that tracks power in watts.

### FEATURES

- Integrated sub-max heart rate testing
- Interval and Sprint 8" program
- Intuitive touchscreen design
- Engaging graphics
- ANT+ and Bluetooth enabled



The S-Drive Power delivers a complete target training experience that will redefine your circuits with intensity and versatility.



## S-DRIVE™ METRICS

The S-Drive Metrics includes a pivoting, quick-response, backlit LCD that clearly displays speed, time, distance and heart rate (with strap) so trainers can view feedback. A self-powered design makes it easy to fit the S-Drive Metrics into virtually any circuit training program and reposition it as needed to keep circuits fresh.

### FEATURES

- Interval and Sprint 8" program
- Self-powered design



ENDURANCE ELLIPTICAL

## S-DRIVE PERFORMANCE TRAINER

Add our original S-Drive Performance Trainer to existing circuit training programs to offer members power walking, running, HIIT, sled-pushing, parachute training and agility drills in one space-saving footprint. Magnetic resistance adjusts easily to a wide range of ability levels. A self-powered design makes it easy to fit S-Drive into virtually any circuit training program and reposition it as needed to keep circuits fresh.

### FEATURES

- Self-powered design

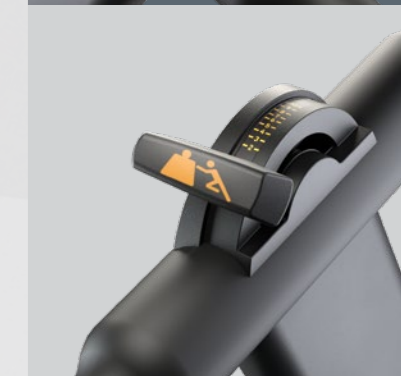

S-DRIVE PERFORMANCE TRAINER | 39



S-FORCE™ PERFORMANCE TRAINER

## INTENSE BY DESIGN

The S-Force Performance Trainer combines a specifically designed motion, two active positions and magnetic resistance to build speed and power and take HIIT workouts to the next level.

# S-FORCE PERFORMANCE TRAINER



# S-FORCE™ PERFORMANCE TRAINER

The S-Force leverages intelligent biomechanics to create a rigorous exercise experience, whether you're using it as a challenging part of your circuit, for small group training or as a stand-alone station on your cardio floor.

## PROGRESSIVE PERFORMANCE

As members move through a user-defined path with a variable stride length up to 91 cm / 36", the magnetic system automatically increases resistance the harder they work. This progressive design means that each interval will challenge HIIT enthusiasts and even elite athletes. Additionally, two active positions — upright and acceleration — make it easy to target a range of leg muscles for a more complete workout in less time.

## ERGONOMIC & LOW-IMPACT

Our quiet, smooth-moving build includes a backlit console for feedback and quick keys for instant access to training programs, plus foot platforms and an ergonomically contoured seat for excellent stability when entering and exiting. Low-impact movement patterns help protect joints, and the cord-free design means that the S-Force can be placed wherever it works best for your coaches and athletes.



## S-FORCE HIIT PROTOCOLS

Our complete collection of HIIT protocols include our exclusive Sprint 8" program, a variety of interval lengths and HIIT ladders to make group and circuit training more intense and engaging than ever. The diverse selection of high-intensity interval training will keep every session fresh, and the fat burning, muscle-building results will ensure that your members keep coming back for more.

## SPEED TECHNIQUE PROTOCOLS

The Matrix Speed Technique Protocols combine the uniquely challenging designs of S-Force and the S-Drive™ Performance Trainer to take your athletes to the apex of speed. Simply follow our original protocols to help athletes of all kinds reach their ultimate potential in acceleration, top-end speed and change-of-direction movement.

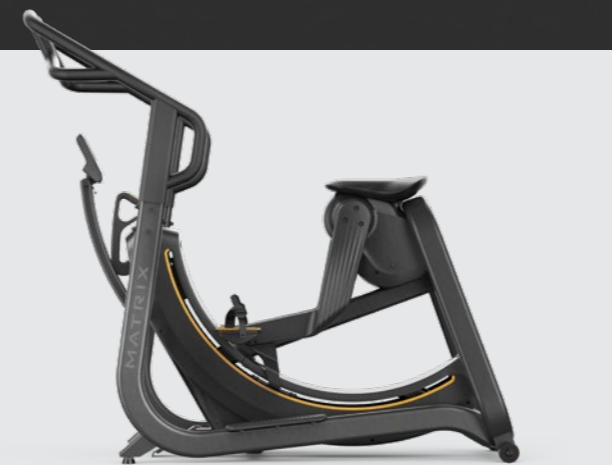

**S-FORCE**  
PERFORMANCE TRAINER

ROWERS

## A NATURALLY INTENSE ROWING EXPERIENCE

Take advantage of the growing popularity of group rowing by bringing one of our sleek, thoughtfully designed rowers to your circuit.



# ROWERS



# ROWERS

The versatile, exceptionally comfortable design of our rowers make it easy to switch between speed work, distance rowing and high-intensity interval training. Choose our original rower for the accurate, complete data feedback of our LCD console, or choose our RXP Rower to add our exclusive Target Training Display and take group rowing to the next level with personalized metrics that matter.

## ADVANCED ENGINEERING

The smart design of our rowers makes it easier than ever to select resistance levels, set your training target and switch between programs. Sleek-yet-robust design offers whisper-quiet operation, a smoother stroke, easy adjustments and repeatable resistance levels to create an unmatched rowing experience. Count on an aluminum flywheel with 10 precise magnetic resistance settings to challenge first-time users and experienced rowers alike.

## ENHANCED COMFORT & CONVENIENCE

Crafted to fit the human body, our rowers feature an Ergo Form seat to reduce stress on touchpoints during long rowing sessions, a seat lock for superior stability when getting on and off and a long handle with a comfort-enhancing over-mold. To make sure every experience is as seamlessly convenient as it is comfortable, we added heel cups with quick-release buckles ideal for fast-moving training circuits and transport wheels for easy rearranging between sessions. Our rowers can even stand vertically, minimizing their footprints when not in use.

## LASTING DURABILITY & STREAMLINED SERVICE

Created specifically for the busiest circuit training environments, our rowers are ready for a steady stream of users, day in and day out. A high-quality rope is paired with a long aluminum rail reinforced with stainless-steel to stand up to hard use. The magnetic resistance system reduces the number of moving parts to enhance durability and minimize maintenance.



## ROWING PROTOCOLS

We offer aerobic workouts focused on rhythm, technique, proper breathing and a pace designed to maintain a steady heart rate; anaerobic threshold workouts that challenge rowers to achieve the same meters or time in each set; and race-pace workouts that emphasize short intervals of maximum effort. Each protocol includes warmup and cooldown.

## CIRCUIT TRAINING PROGRAMS

Use our rower in large or small group circuit training programs to complement existing TRX stations, dumbbell stations, core stations, plyometric stations and more, providing the kind of full-body workout intensity that makes your circuit training program unlike any other.

## SPORTS PERFORMANCE TRAINING

Quick keys make interval training easy to access, and complete, accurate console data feedback helps instructors refine form and quickly adjust difficulty to help rowers reach their ultimate potential.

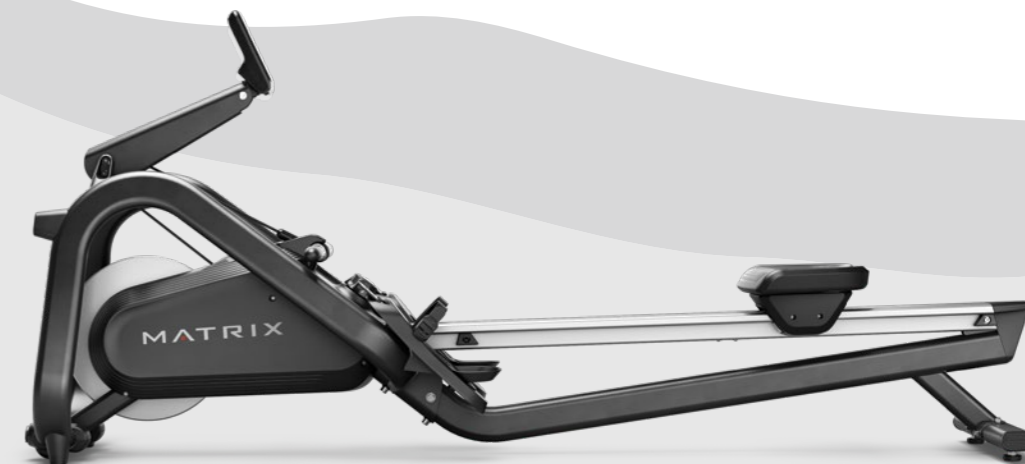



## RXP ROWER

Reinvigorate rowing and make your facility stand out by adding our advanced RXP Target Training Rower to your circuit, group classes or cardio floor. Our unique display is specifically engineered for target training — measuring watts, 500-meter split, heart rate, SPMs, distance or calories — and a bright LED wrap uses vibrant colors to indicate if the user is on track for their goals. Integrated training programs help members make the most of every circuit or class, and a wide range of personal training programs offers a fresh experience outside of group settings.

### FEATURES

- Sub-max heart rate test, step power test and testing for 500- and 2,000-meter
- Interval and Sprint 8" program
- Intuitive touchscreen design
- Engaging graphics
- WiFi, ANT+ and BLE FTMS enabled



RXP ROWER

## ROWER

The Matrix Rower features an adjustable, backlit console that makes it easy to access training programs and see complete workout data. Clearly defined quick keys provide instant access to integrated training programs. Thanks to a self-powered design, you can find a place for our rower in any large or small circuit training program. Simply place it between weight and functional training stations for an engaging change of pace.

### FEATURES

- Challenge and interval programs
- Self-powered design



GROUP TRAINING LED CONSOLE

## KEEP YOUR MEMBERS IN SYNC

Now you can keep every member of your class in sync with a console made specifically for training in a group.



# GROUP TRAINING LED CONSOLE

## GROUP TRAINING LED CONSOLE

Make your group exercise classes smoother and more rewarding for everyone involved with our Group Training LED Console. Our versatile design also makes it easier to work with participants of different ability levels. The straightforward interface is easy for anyone to navigate, and smart features like one-touch controls and preset intensity levels help every participant stay in sync with instructor cues. You can even add WiFi to work with some of our most powerful Connected Solutions, like Engage 360, Community 360 and Asset Management™. Our Group Training LED Console is compatible with our Performance Plus Treadmill and all Matrix cardio equipment from our Performance, Endurance and Lifestyle Series.

**CONNECTED**  
SOLUTIONS

ASSET MANAGEMENT

ENGAGE 360

COMMUNITY 360



CONSOLE SPECS	GROUP TRAINING LED
DISPLAY	Large number LED with message center
WORKOUTS	Manual
LANGUAGES	English, German, French, Italian, Spanish, Dutch, Portuguese, Swedish, Finnish, Turkish, Danish, Polish
FAN	No
ANALOG TV	Optional - attachable add-on TV
DIGITAL TV	Optional - attachable add-on TV
IPTV	No
PRO:IDIOM COMPATIBILITY	Optional - attachable add-on Pro:Idiom TV (≠ IPTV)
WIFI	Optional - included with Asset Management and/or Community 360 app
BLUETOOTH	No
ANT+	No
RFID WIRELESS LOGIN	Optional
CONNECTS TO APPLE WATCH	No
MADE FOR IPOD, IPHONE, IPAD	No
USB PORT	Yes - device charging, software updates
WIRELESS CHARGING (Qi)	No
CSAFE READY	Yes
AUTO WAKE-UP	No





CONNEXUS™ FUNCTIONAL TRAINING SOLUTIONS

## EXCITING, ATHLETIC, VERSATILE FUNCTIONAL TRAINING SOLUTIONS

Solutions. Whether you want to provide coached experiences or create a space for individuals to train on their own or with a personal trainer, we have a solution for you.

# CONNEXUS FUNCTIONAL TRAINING SYSTEM

# CONNEXUS™ FUNCTIONAL ZONE SOLUTIONS

Ideal for functional training coached experiences where users perform weight-bearing exercises that reflect their daily activities, Connexus gives club owners and trainers maximum flexibility, virtually unlimited expandability and the ability to offer immediate feedback to help refine user form. Like everything from Matrix, the heavy-duty steel frames of our Connexus units are built to withstand intense use from a steady stream of members.

## VERSATILITY

Our Connexus stations feature numerous attachment points for bars, bands, med balls, boxing bags, TRX straps and more depending on the station that's right for your facility. This gives trainers ultimate flexibility to design their own protocols and the ability to build variety into the programming they offer individuals, small groups and classes.

## ADJUSTABILITY

Connexus features low, mid and high anchor points that accommodate body weight, resistance and flexibility training for a wide range of individuals and ability levels. Plus, easy-release attachment points simplify setup and transitions between exercises to keep training sessions moving smoothly with little downtime.

## REPEATABILITY

We designed Connexus for small group training as well as functional training classes in which multiple users can perform the same exercises at the same time.

## ACCESSIBILITY

Simple setup and operation along with the vast array of exercises make it easy for beginners to try Connexus for the first time and for experienced athletes to use it for regular training. While ideal for group training, Connexus works just as well for individuals looking to augment their own strength or flexibility between classes.

# CONNEXUS



# CONNEXUS™ FUNCTIONAL TRAINING SOLUTIONS

## OPTIONAL MED BALL TARGET

Divided into three training zones (low, mid and high), the optional med ball target can be used with slam balls and a wide variety of med balls to enhance power training programs and offer program variety.

## OPTIONAL MAGNETIC CHALKBOARD

The optional magnetic chalkboard features a storage slot for chalk, a smart phone or a tablet. It allows trainers to post workout information in highly visible area.

## OPTIONAL LANDMINE ATTACHMENT

For additional flexibility, the optional landmine attachment allows trainers to incorporate more explosive power training into their programming.

## OPTIONAL BATTLE ROPE ATTACHMENT

Chrome-plated base anchors offer convenient attachment points for battle ropes that test the limits of strength and endurance with dynamic movements.



## TRAINING SUPPORT

### TRX SUSPENSION TRAINING MODULE

Developed by the head of education for TRX Suspension Training, the Connexus TRX Module brings the intense challenge and superior results of TRX training to your Connexus group functional training installation. The Connexus TRX Module is a progressive, four-week program with two original weekly workouts for small group or one-on-one training.

### BAND & BALL TRAINING MODULE

The Band & Ball Module is a progressive, four-week program with three original weekly workouts that build strength and power. Using resistance bands and slam balls, these workouts teach the body to work as an integrated system. Workouts are easily modified for greater or less intensity and are applicable for small group or one-on-one training.

### BOXING TRAINING MODULE

Workouts that engage the legs, hips, glutes, core, obliques, back, shoulders, chest and arms by punching against resistance. Workouts are easily modified for greater or less intensity and are applicable for small group or one-on-one training.

### BODY SCULPT TRAINING MODULE

This progressive, full-body strength program emphasizes tempo training to accomplish a targeted goal each week, maximizing muscle strength and hypertrophy. Three forms of resistance training are accomplished using the landmine attachment, flat circular bands and TRX suspension straps. Workouts are easily modified for greater or less intensity and are applicable for small group or one-on-one training.

### EXERCISE LIBRARY

Access a complete index of over 200 Connexus exercises that instructors can use to build and choreograph their own original classes and training routines. They can also use the library to modify existing programming by finding alternate exercises to raise or lower program intensity for members of varying skill and fitness levels. Visit our expansive online Exercise Library on Matrix Learning ([www.matrixlearningcenter.com](http://www.matrixlearningcenter.com)) to see images and videos of each exercise.

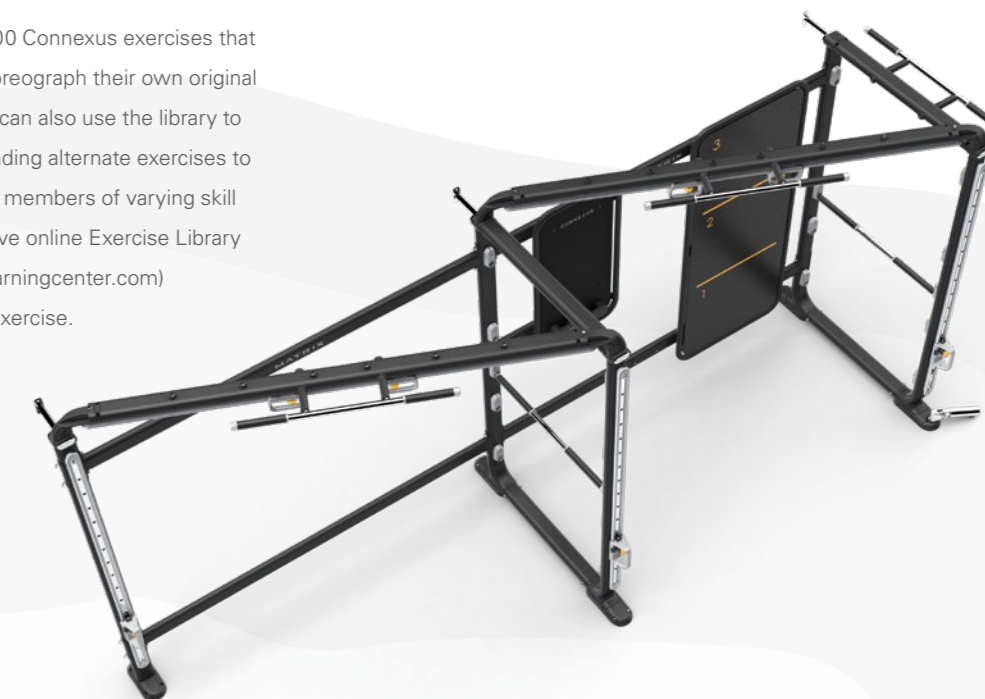

## CONNEXUS™ PERIMETER

Our wall-mounted Connexus Perimeter unit lets you tap into underutilized wall and corner space to offer high-impact training. Connexus Perimeter features low, mid and high anchor points that accommodate bodyweight, resistance and flexibility training for a wide range of individuals and ability levels. Enhanced adjustability simplifies setup and transitions between exercises to keep classes and training sessions moving smoothly with little downtime.

### OPTIONS

- Connexus Perimeter Expansion Kit
- Med Ball Target
- Magnetic Chalkboard
- Landmine Attachment
- Battle Rope Attachment

CONNEXUS



\* As shown with optional med ball target, magnetic chalkboard, battle rope and landmine attachment.



CONNEXUS PERIMETER

## CONNEXUS PERIMETER EXPANSION KIT

Expansion kits for Connexus Perimeter offer an efficient and cost-effective way to add training capacity and accommodate as many group or circuit training stations as your space allows. Trainers can create a circuit of unique stations or a small group training area where multiple individuals can perform the same exercise at the same time. With our expansion kit, it's easy to reimagine your functional training offering as your needs change and popularity grows.

### OPTIONS

- Med Ball Target
- Magnetic Chalkboard
- Landmine Attachment
- Battle Rope Attachment



\* As shown with optional med ball target, magnetic chalkboard, battle rope and landmine attachment.



CONNEXUS EXPANSION KIT | 61

## CONNEXUS™ FREE

Connexus Free is a complete freestanding system with multiple training stations that users can access from all sides. Connexus Free features low, mid and high anchor points that accommodate bodyweight, resistance and flexibility training for a wide range of individuals and ability levels. Enhanced adjustability simplifies setup and transitions between exercises to keep class and training sessions moving smoothly with little downtime. Connexus Free has everything you need for a multi-person functional training system on the weight room floor or in a dedicated space.

### OPTIONS

- Med Ball Target
- Magnetic Chalkboard
- Landmine Attachment
- Battle Rope Attachment



\* As shown with optional med ball target, magnetic chalkboard, battle rope and landmine attachment.



CONNEXUS FREE

## CONNEXUS COMPACT

The Connexus Compact turns any unused area into a space where members can take on a full range of exercises ideal for building a lean, strong body. Our smart, streamlined design includes two height-adjustable training handles, great for bilateral training or serving multiple users at once. A durable hinged med ball target protects your walls while providing a convenient location for explosive throwing exercises, and the med ball target easily folds out of the way for access to the unit's integrated accessory storage space. The ergonomic pull-up bar comfortably accommodates wide and narrow grips, the landmine attachment rotates a full 360 degrees for exercise variety, and the base anchor provides a perfectly placed attachment point for battle ropes and bands.



CONNEXUS



## CONNEXUS™ COLUMN

If you're looking to make room for more functional training options at your facility, you can add our space-efficient Connexus Column virtually anywhere you have an unused wall. A height-adjustable training handle makes it easy to attach resistance bands and suspension straps, accommodating multiple bands at once to streamline transitions, progressions and training with different users. Integrated device storage for smartphones keeps training apps in view, even amplifying device sound so users never miss a moment of instruction, and built-in band storage helps keep your functional training area tidy.



CONNEXUS  
COLUMN

CONNEXUS

## CONNEXUS STEP+

A great addition for circuits, personal training and independent functional training workouts, the Connexus Step+ is as space-efficient as it is versatile. Functional training enthusiasts of virtually any ability level can use the step in two configurations — standard and inverted — to take on a full spectrum of challenging core, lower-body and cardio exercises that are excellent for improving body composition and augmenting overall functional fitness. The smart, stackable design includes a thoughtfully textured balance surface and optimized height, width and depth for use that's as secure as it is effective, plus durable construction that stands up to hard use by members.



CONNEXUS

## CONNEXUS™ STORAGE STATION

Our ultra-durable Connexus Storage Station makes it easy to clean up your functional training area while keeping your most important accessories on hand and ready to go. Two extra-large, rubber-cushioned shelves provide plenty of low-to-the-ground storage space for your heavy-duty pieces, while two secondary shelves give you ample space to organize lighter accessories by size or type. An open top rack offers storage versatility to accommodate large or long items, and an open base adds even more space to tuck away functional training extras. For the bands, straps and ropes crucial to your functional training program, multiple angled pegs with rubber endcaps offer easy-access hanging storage. Our Storage Station also includes directional placards so members and trainers can clearly identify where each accessory belongs. Maximize storage capabilities with the optional mat hanger (GFTORG-MH) to store mats vertically for faster drying and to prevent curling.



CONNEXUS STORAGE STATION

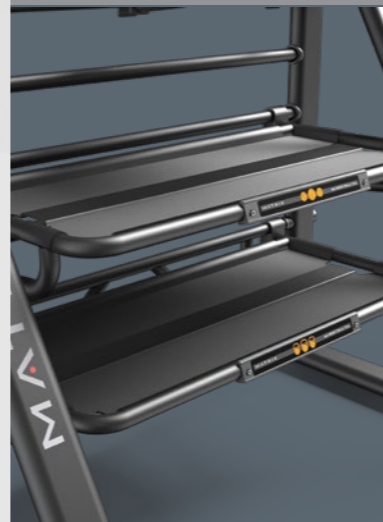

CONNEXUS

## CONNEXUS STORAGE CARTS

Connexus Storage Carts keep accessories and attachments close at hand for easy setup and transition between classes or groups, and heavy-duty casters make it easy to transport equipment around your facility. These highly accessible and sturdy storage solutions also keep your facility neat and organized at all times. Choose a two-shelf cart with a maximum capacity of 226 kg / 500 lbs. or a three-shelf cart with a maximum capacity of 317 kg / 750 lbs.

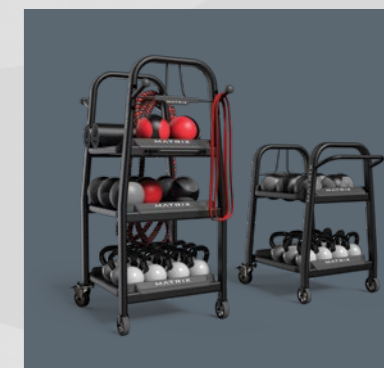

CONNEXUS

MX4™ TRAINING SYSTEM

**INSPIRE MEMBERS. DELIVER RESULTS.  
AND DRIVE REVENUE LIKE NEVER BEFORE.**

Only MX4 combines Matrix-exclusive equipment and original turnkey programming to create signature group exercise experiences that members will come back for again and again.

# MX4 TRAINING SYSTEM

A man in a red shirt is rowing on a Matrix MX4 rowing machine in a gym. In the background, a woman is also on a rowing machine, and another man is holding a medicine ball. The gym has large windows and modern equipment. The text 'MX4 TRAINING SYSTEM' is overlaid in large, bold, grey letters.

# MX4™ TRAINING SYSTEM

If you're looking to drive revenue and differentiate your group training offering in a way that engages members and delivers results, then you need to bring the MX4 Training System to your facility. Our original MX4 program inspires even the most passionate exercise enthusiasts to push themselves further, redefining power, strength, endurance and cardio fitness. Our MX4 Active program uses the same versatile equipment with low-impact, lower-back friendly movements to help older and deconditioned adults build stability, functional strength, flexibility and cardiovascular health. With our exclusive equipment and signature Matrix programming at your fingertips, you'll be able to reach more members and fill your timetable with classes they come back for again and again.

## LEARN FROM CERTIFIED MASTER TRAINERS

Certified Matrix Master Trainers will come to your facility to teach you and your trainers everything you need to help participants establish overall conditioning, enhance their existing abilities and elevate their fitness with MX4.

## POWERED BY MATRIX-EXCLUSIVE EQUIPMENT

The MX4 Training System leverages Matrix-exclusive equipment like our Connexus™ Functional Training System, Connexus Step+, S-Drive™ Performance Trainer, Rower and S-Force™ Performance Trainer. These unique tools can be used in virtually limitless combinations in both the original MX4 and MX4 Active, keeping group training fresh and engaging so that your members are sure to come back for more.

## FULL BUSINESS SUPPORT

We'll be there every step of the way to make sure your facility is ready to launch MX4. Our education team will walk you through the entire process, providing timelines to optimize your launch to members and working with you to define the optimal business model and pricing structure.

## TURNKEY SOLUTIONS

Our turnkey solutions give you everything you need to make MX4 a success. The complete package includes marketing support, business support, and complete access to our original programming and exercises via the Matrix Group Education Platform. You can even access signature workouts via Myzone.





## MX4

### MX4™ SMALL GROUP TRAINING COURSE

The original MX4 Small Group Training Course is a workshop that teaches trainers and coaches how to run a successful, community-building program that challenges cardio, power, strength and endurance for an intense group exercise experience that burns fat and builds muscle. Using the Connexus™ Functional Training System, Matrix-exclusive cardio modalities and the world's best functional training accessories, course participants will learn everything they need to reach more members than traditional group training ever could.

### COURSE INCLUDES

- Instruction on how to run a successful 30-minute small group training program
- Information about the unique benefits of small group training classes using functional training systems like Connexus
- Essential direction for setting up and coaching small group training classes effectively
- Ways to integrate best-in-class functional training tools like the TRX suspension trainer, soft-shell med ball, flat circular bands, kettlebells, landmine, slam balls and battle ropes
- Guidance on how to integrate traditional and non-traditional cardio exercises with functional training tools to maximize results
- Access to an online exercise library demonstrating exercise movements and training support
- 156 unique, turnkey 30-minute group training workouts with built-in progression for groups of four to 12 participants

### MX4 ACCREDITATIONS

ACE (0.5 CECs), AFAA (5 CEUs), NASM (0.5 CEUs), NSCA (0.5 CEUs), CanFitPro (5 CECs)

**MX4™ ACTIVE SMALL GROUP TRAINING COURSE**

The MX4 Active Small Group Training Course is a workshop that teaches trainers and coaches how to run a successful small group training program that helps older and deconditioned adults build stability, functional strength, flexibility and cardiovascular health in a way right for their abilities. Using the same products as the original MX4, trainers will learn everything they need to incorporate low-impact, lower-back friendly exercises, familiar repetitions and natural progressions for a confidence-inspiring experience that improves overall fitness.

**COURSE INCLUDES**

- Instruction on how to run a successful 45-minute session
- Essential direction for setting up and delivering a personalized coaching experience to address the needs of those across a wide range of ages and abilities
- Guidance on how to integrate the pre-participation assessment for sessions populated by older participants to determine class readiness
- Information about blending cardio-based modalities with the unique benefits of functional movement training to support gradual improvements to fitness and blood vessel function
- Instruction on using choreographed warmup and cooldown routines tailored to meet the unique needs of older and deconditioned adults
- Access to an online exercise library demonstrating exercise movements and training support
- 26 turnkey, structured workouts with nearly 100 exercises and built-in progression for groups of four to eight participants with a lower baseline of fitness

**MX4 ACCREDITATIONS**

ACE (0.3 CECS), AFAA (3 CEUs), NASM (0.3 CEUs), NSCA (0.3 CEUs), CanFitPro (3 CECs)



TRAINING CYCLES			
	CXP	CXM	CXC
MODEL NUMBER	CXP-02	CXM	CXC
Power Measurement (Watt)	Displays watts within +/- 3% accuracy	Displays watts within +/- 10% accuracy	No
Console	Target Training capacitive touchscreen	Backlit LCD	Optional LCD
Generator Powered	Yes	No	No
Training Intensity Guide	Yes	No	No
Telemetric HR	Yes, 5khz, ANT+ and BLE	Yes, 5khz, ANT+ and BLE	Yes
WiFi Enabled	No	No	No
ANT+/BLE FTMS enabled	Yes	Yes	No
Programs	Target Training (RPM, Watts, HR, Calories, Distance); Goal-based Workouts: Time, Distance, Calories per Hour, Intervals, Pace, Sprint 8, Target HR.	Intervals	No
Fitness Tests	FTP 8 min, FTP 20 min, and sub max HR test	No	No
Resistance System	Magnetic	Magnetic	Magnetic
Emergency Stop	Push	Push	Push
Flywheel	Rear, aluminum, evenly-weighted	Rear, aluminum, evenly-weighted	Rear, aluminum, evenly-weighted
Adjustment Type	Quick-touch levers	Quick-touch levers	Quick-touch levers
Posts & Sliders	Aluminum, pin-to-lock adjustment	Aluminum, pin-to-lock adjustment	Aluminum, pin-to-lock adjustment
Handlebar Adjustments	Vertical & horizontal	Vertical & horizontal	Vertical & horizontal
Saddle	Ergonomically sculpted seat	Ergonomically sculpted seat	Ergonomically sculpted seat
Handlebar	Ergo-formed, multi-position, soft PVC	Ergo-formed, multi-position, soft PVC	Ergo-formed, multi-position, soft PVC
Saddle Adjustments	Vertical & horizontal	Vertical & horizontal	Vertical & horizontal
Water Bottle Holder	Dual, integrated on handlebar	Dual, integrated on handlebar	Dual, integrated on handlebar
<b>DRIVE SYSTEM</b>			
Drivetrain	Flexonic belt	Flexonic belt	Flexonic belt
Drivetrain Gear Ratio	1:10	1:10	1:10
<b>FRAME</b>			
Frame Color	Matte black	Matte black	Matte black
Frame Material	Steel	Steel	Steel
Shrouds & Guards	Full frame	Full frame	Full frame
Frame Design	Off-set	Off-set	Off-set
Q Factor	168 mm / 6.6"	168 mm / 6.6"	168 mm / 6.6"
Crank Type	Forged steel 170 mm	Forged steel 170 mm	Forged steel 170 mm
Pedal Type	Dual-sided SPD & easy-fit strap	Dual-sided SPD & toe cage	Dual-sided SPD & toe cage
Frame Stabilizer Bars	Oversized, hidden bolts & fixings	Oversized, hidden bolts & fixings	Oversized, hidden bolts & fixings
Protection Plates	Yes with rear-access stretch plates	Yes	Yes
Leveling Feet	4; with 2 rear easy-access dial levers	4	4
Transport Wheels	2	2	2
<b>TECH SPECS</b>			
Overall Dimensions (L x W x H)	122.4 x 56 x 102.8 cm / 48.2" x 22.2" x 40.5"	122.4 x 56 x 102.8 cm / 48.2" x 22.2" x 40.5"	122.4 x 56 x 102.8 cm / 48.2" x 22.2" x 40.5"
Product Weight	57.6 kg / 127 lbs.	56.5 kg / 124.5 lbs.	55.2 kg / 121.6 lbs.
Max User Weight	158.76 kg / 350 lbs.	158.76 kg / 350 lbs.	158.76 kg / 350 lbs.

	PRODUCT DIMENSIONS						PRODUCT WEIGHT		RECOMMENDED TRAINING AREA				MAX LOAD WEIGHT	
	METRIC (CM)			ENGLISH (IN)			METRIC	ENGLISH	METRIC (CM)		ENGLISH (IN)		METRIC	ENGLISH
	L	W	H	L	W	H	KG	LBS.	L	W	L	W	KG	LBS.
GFTWM – Perimeter	275	158	239	108	62	94	225	496	600	430	238	169	N/A	N/A
GFTXP – Expansion Kit	244	158	239	96	62	94	175	386	Adds 200 x 400 cm / 96" x 168" to training area				N/A	N/A
GFTFS – Free	290	277	239	114	109	94	315	694	800	800	312	312	N/A	N/A
GFTMB – Optional Med Ball Target	193	86	13	76	34	5	50	110						
GFTCB – Optional Magnetic Chalkboard	109	60	17	43	24	7	18	40						
GFTLM – Optional Landmine Attachment	36	13	10	14	5	4	3	7						
GFTCOR – Compact	82	165	240	32.3	65	94.4	205	452	426	426	168	168	N/A	N/A
GFTSLR – Column	44.5	16.1	212	17.5	6.3	83.5	25.5	56.2	N/A	N/A	N/A	N/A	N/A	N/A
GFTSS – Step+	70.5	38.1	32.7	27.8	15	12.9	8.4	18.5	N/A	N/A	N/A	N/A	136	300
GFT2S – 2-shelf Storage Cart	79	109	122	31	43	48	73	161	N/A	N/A	N/A	N/A	227	500
GFT3S – 3-shelf Storage Cart	79	123	174	31	48	68	104	229	N/A	N/A	N/A	N/A	340	750
GFTORG – Storage Station	85	140	185	33.5	55.1	72.9	160	352.7	N/A	N/A	N/A	N/A	363	800
GFTORG-MH – Mat Hanger	70	24	33	27.7	9.5	13.1	3.5	7.7	N/A	N/A	N/A	N/A	N/A	N/A

S-DRIVE™ PERFORMANCE TRAINERS			
	S-DRIVE POWER	S-DRIVE METRICS	S-DRIVE PERFORMANCE TRAINER
MODEL NUMBER	S-DRIVEP	S-DRIVEM	S-DRIVEC
Resistance Type	Independent sled and parachute brakes	Independent sled and parachute brakes	Independent sled and parachute brakes
User Harness	Adjustable, connection free harness	Adjustable, connection free harness	Adjustable, connection free harness
Deck Type	Reversible silicone 2.5 cm / 1" deck	Reversible silicone 2.5 cm / 1" deck	Reversible silicone 2.5 cm / 1" deck
Console	Target Training capacitive touchscreen	Backlit LCD	No
Generator Powered	Yes	Yes	No
Training Intensity Guide	Yes, 5khz, ANT+ and BLE	Yes	No
Telemetric HR	Yes	Yes	No
WiFi Enabled	Yes	No	No
ANT+/ BLE FTMS enabled	Yes	Yes	No
Resistance System	Magnetic	Magnetic	Magnetic
Running Belt Type	Forbo, commercial grade	Forbo, commercial grade	Forbo, commercial grade
Running Area	152 x 51 cm / 60" x 22"	152 x 51 cm / 60" x 22"	152 x 51 cm / 60" x 22"
Step-on Height	17.8 cm / 7"	17.8 cm / 7"	17.8 cm / 7"
Incline Range	7° fixed	7° fixed	7° fixed
Speed Range	User-defined	User-defined	User-defined
<b>TECH SPECS</b>			
Power Requirements	DC plug-in	Self-powered	Self-powered
Sled Brake Maximum Resistance	122.5 kg / 270-lb. sled on natural turf	122.5 kg / 270-lb. sled on natural turf	122.5 kg / 270-lb. sled on natural turf
Assembled Dimensions (L x W x H)	195 x 88.3 x 150 cm / 76.8" x 34.8" x 59"	195 x 88.3 x 150 cm / 76.8" x 34.8" x 59"	195 x 88.3 x 150 cm / 76.8" x 34.8" x 59"
Max User Weight	182 kg / 400 lbs.	182 kg / 400 lbs.	182 kg / 400 lbs.
Assembled Weight	122.5 kg / 270 lbs.	122.5 kg / 270 lbs.	122.5 kg / 270 lbs.
Shipping Weight	145.2 kg / 320 lbs.	145.2 kg / 320 lbs.	145.2 kg / 320 lbs.

ROWERS		
	RXP	ROWER
MODEL NUMBER	AR12	AR11
<b>CONSOLE</b>		
Display Screen	Target Training capacitive touchscreen	Extra-large backlit LCD display
Display Feedback	Time, Distance, SPM, Watts, Heart Rate, Calories, 500 m/split	Time, Distance, SPM (strokes per minute), Stroke, Watts, Heart Rate, Calories, 500 m/split
Programs	Target Training (SPM, Watts, HR, Calories, Distance, 500 m/split); Goal-based: Time, Distance, Calories, Calories per Hour, Intervals, Pace, Sprint 8, Target HR	Manual, Interval, Challenge
Fitness Tests	500 meter, 2000 meter, step power test, sub max HR test	No
WiFi Enabled	Yes	No
ANT+ / Bluetooth enabled	Yes	No
Telemetric Receiver	Yes - 5 khz, ANT+/BLE	Yes -5 khz
<b>TECH SPECS</b>		
Resistance Technology	Magnetic resistance	Magnetic resistance
Resistance Levels	10	10
Drive System	Coil spring poly-V belt	Coil spring poly-V belt
Max User Weight	158.76 kg / 350 lbs.	158.76 kg / 350 lbs.
Product Weight	59 kg / 130 lbs.	59 kg / 130 lbs.
Shipping Weight	70.5 kg / 155.4 lbs.	69 kg / 152 lbs.
Overall Dimensions (L x W x H)	223 x 55 X 58 cm / 87.7" x 21.6" x 22.8"	223 x 55 x 58 cm / 87.7" x 21.6" x 22.8"
Power Requirement	DC plug-in and generator powered	Generator powered LCD display w/ back-up memory battery
<b>SPECIAL FEATURES</b>		
Handlebar Design	Extra-long ergo-grip handlebar	Extra-long ergo-grip handlebar
Foot Stretchers	Adjustable heel cups with easy-to-read settings	Adjustable heel cups with easy-to-read settings
Monorail	Aluminum	Aluminum

S-FORCE™ PERFORMANCE TRAINER	
MODEL NUMBER	SPT
<b>CONSOLE</b>	
Display Screen	Extra-large backlit LCD display
Display Feedback	Time, Distance, SPM (steps per minute), Steps, Heart Rate (with heart rate strap), Calories
Programs	Sprint 8, Goals, Interval, Challenge
Telemetric Receiver	Yes
<b>TECH SPECS</b>	
Resistance Technology	Magnetic Resistance
Max User Weight	181.4 kg / 400 lbs.
Product Weight	132 kg / 290 lbs.
Shipping Weight	155 kg / 340 lbs.
Overall Dimensions (L x W x H)	182 x 69 x 166 cm / 72" x 27" x 66"
Power Requirements	3 D-cell batteries
<b>SPECIAL FEATURES</b>	
Stride Length	91.4 cm / 36"
Resistance Levels	5
Handlebar Design	Multi-position handlebar
Pedals	Self-leveling with quick-release strap
Transport	3 wheel transport

Product specifications are subject to change without notice. For warranty & service information, visit: [matrixfitness.com/support](https://matrixfitness.com/support)

# A TRULY GLOBAL COMPANY

## AUSTRALIA / NEW ZEALAND

Johnson Health Tech Australia Pty. Ltd.

## BRAZIL

Johnson Health Tech Brasil

## CANADA

Johnson Health Tech Canada

## CHINA

Johnson Health Tech (Shanghai) Co., Ltd.

## CZECH REPUBLIC / SLOVAKIA

Johnson Health Tech CZ & SK a.s.

## DENMARK

Johnson Health Tech Denmark ApS

## FRANCE

Johnson Health Tech France

## GERMANY / AUSTRIA

Johnson Health Tech GmbH

## GREECE / BULGARIA / CYPRUS

Johnson Health Tech Hellas SA

## HONG KONG

Johnson Health Tech Hong Kong

## INDONESIA

Johnson Health Tech Indonesia

## INDIA

Johnson Health Tech India, Pvt. Ltd.

## ITALY

Johnson Health Tech Italia Spa

## JAPAN

Johnson Health Tech Japan

## KOREA

Johnson Health Tech Co., Ltd. Korea

## MALAYSIA

Johnson Fitness (Malaysia) SDN. BHD.

## MEXICO

Johnson Health Tech Mexico

## NETHERLANDS / BELGIUM / LUXEMBOURG

Matrix Fitness Benelux

## PHILIPPINES

Johnson Health Tech Philippines Inc.

## POLAND

Johnson Health Tech Sp. Z. O. O.

## ROMANIA

Johnson Health Tech Romania

## RUSSIA

Johnson Health Tech Russia

## SOUTH AFRICA

Johnson Health Tech South Africa (PTY) Ltd.

## SPAIN / PORTUGAL

Johnson Health Tech Ibérica SL

## SWITZERLAND

Johnson Health Tech (Schweiz) GmbH

## TAIWAN

Johnson Health Tech Taiwan

## THAILAND / CAMBODIA / LAOS / MYANMAR

Johnson Health Tech (Thailand) Co., Ltd.

## TURKEY

Johnson Health Tech Turkey

## UNITED ARAB EMIRATES / SAUDI ARABIA / KUWAIT / QATAR / OMAN / JORDAN

Johnson Health Tech Middle East

## UNITED KINGDOM

Johnson Health Tech UK Ltd.

## UNITED STATES

Johnson Health Tech North America

## VIETNAM

Johnson Health Tech (Vietnam) Co. Ltd.

# MATRIX

## ABOUT MATRIX FITNESS

In 2001, Johnson Health Tech established Matrix Fitness to bring premium fitness equipment to the marketplace. Since then, we've become the fastest-growing commercial fitness equipment brand in the world. Matrix has leveraged continuous innovation and cross-cultural collaboration to emerge as an industry vanguard, constantly challenging standards and raising expectations for fitness equipment design and exercise technology.

Our product portfolio has expanded to over 500 products including strength equipment, cardio platforms, group exercise modalities, athletic performance training tools, fitness technology, integrated HIIT workouts, turnkey programming and much more. With over 30 subsidiaries around the world, Matrix is uniquely equipped to meet fitness and wellness needs in every corner of the globe.

Today, Matrix Fitness is dedicated to serving fitness facilities of all kinds, setting them apart in ways that attract and retain more members. Our mission is to delight and excite our customers through complete solutions and committed partnership provided by a world-class organization.



Visit [matrixfitness.com](http://matrixfitness.com) for full contact information.



**MATRIX**  
Strong • Smart • Beautiful

**Matrix Fitness**

1600 Landmark Drive  
Cottage Grove, WI 53527 USA

   matrixfitnessusa  
matrixfitness.com | 866.693.4863

©2023 Matrix Fitness. All Rights Reserved.

AUTHORIZED MATRIX FITNESS DISTRIBUTOR