

Region 4 Education Service Center (ESC)

Contract # R201104

for

Athletic, Physical Education Supplies, and Team Uniforms

with

School Health Corporation

Effective: October 1, 2020

The following documents comprise the executed contract between the Region 4 Education Service Center and School Health Corporation, effective October 1, 2020:

- I. Vendor Contract and Signature Form
- II. Supplier's Response to the RFP, incorporated by reference

CONTRACT

This Contract ("Contract") is made as of October 1, 2020 by and between School Health Corporation ("Contractor") and Region 4 Education Service Center ("Region 4 ESC") for the purchase of Athletic, Physical Education Supplies, and Team Uniforms ("the products and services").

RECITALS

WHEREAS, Region 4 ESC issued Request for Proposals Number 20-11 for Athletic, Physical Education Supplies, and Team Uniforms ("RFP"), to which Contractor provided a response ("Proposal"); and

WHEREAS, Region 4 ESC selected Contractor's Proposal and wishes to engage Contractor in providing the services/materials described in the RFP and Proposal;

WHEREAS, both parties agree and understand the following pages will constitute the Contract between the Contractor and Region 4 ESC, having its principal place of business at 7145 West Tidwell Road, Houston, TX 77092.

WHEREAS, Contractor included, in writing, any required exceptions or deviations from these terms, conditions, and specifications; and it is further understood that, if agreed to by Region 4 ESC, said exceptions or deviations are incorporated into the Contract.

WHEREAS, this Contract consists of the provisions set forth below, including provisions of all attachments referenced herein. In the event of a conflict between the provisions set forth below and those contained in any attachment, the provisions set forth below shall control.

WHEREAS, the Contract will provide that any state and local governmental entities, public and private primary, secondary and higher education entities, non-profit entities, and agencies for the public benefit ("Public Agencies") may purchase products and services at prices indicated in the Contract upon the Public Agency's registration with OMNIA Partners.

- 1) Term of agreement. The term of the Contract is for a period of three (3) years unless terminated, canceled or extended as otherwise provided herein. Region 4 ESC shall have the right to renew the Contract for two (2) additional one-year periods or portions thereof. Region 4 ESC shall review the Contract prior to the renewal date and notify the Contractor of Region 4 ESC's intent renew the Contract. Contractor may elect not to renew by providing three hundred sixty-five days' (365) notice to Region 4 ESC. Notwithstanding the expiration of the initial term or any subsequent term or all renewal options, Region 4 ESC and Contractor may mutually agree to extend the term of this Agreement. Contractor acknowledges and understands Region 4 ESC is under no obligation whatsoever to extend the term of this Agreement.
- 2) Scope: Contractor shall perform all duties, responsibilities and obligations, set forth in this agreement, and described in the RFP, incorporated herein by reference as though fully set forth herein.
- 3) Form of Contract. The form of Contract shall be the RFP, the Offeror's proposal and Best and Final Offer(s).

- 4) Order of Precedence. In the event of a conflict in the provisions of the Contract as accepted by Region 4 ESC, the following order of precedence shall prevail:
 - i. This Contract
 - ii. Offeror's Best and Final Offer
 - iii. Offeror's proposal
 - iv. RFP and any addenda
- 5) Commencement of Work. The Contractor is cautioned not to commence any billable work or provide any material or service under this Contract until Contractor receives a purchase order for such work or is otherwise directed to do so in writing by Region 4 ESC.
- 6) Entire Agreement (Parol evidence). The Contract, as specified above, represents the final written expression of agreement. All agreements are contained herein and no other agreements or representations that materially alter it are acceptable.
- 7) Assignment of Contract. No assignment of Contract may be made without the prior written approval of Region 4 ESC. Contractor is required to notify Region 4 ESC when any material change in operations is made (i.e. bankruptcy, change of ownership, merger, etc.).
- 8) Novation. If Contractor sells or transfers all assets or the entire portion of the assets used to perform this Contract, a successor in interest must guarantee to perform all obligations under this Contract. Region 4 ESC reserves the right to accept or reject any new party. A change of name agreement will not change the contractual obligations of Contractor.
- 9) Contract Alterations. No alterations to the terms of this Contract shall be valid or binding unless authorized and signed by Region 4 ESC.
- 10) Adding Authorized Distributors/Dealers. Contractor is prohibited from authorizing additional distributors or dealers, other than those identified at the time of submitting their proposal, to sell under the Contract without notification and prior written approval from Region 4 ESC. Contractor must notify Region 4 ESC each time it wishes to add an authorized distributor or dealer. Purchase orders and payment can only be made to the Contractor unless otherwise approved by Region 4 ESC. Pricing provided to members by added distributors or dealers must also be less than or equal to the Contractor's pricing.
- 11) TERMINATION OF CONTRACT
 - a) Cancellation for Non-Performance or Contractor Deficiency. Region 4 ESC may terminate the Contract if purchase volume is determined to be low volume in any 12-month period. Region 4 ESC reserves the right to cancel the whole or any part of this Contract due to failure by Contractor to carry out any obligation, term or condition of the contract. Region 4 ESC may issue a written deficiency notice to Contractor for acting or failing to act in any of the following:
 - i. Providing material that does not meet the specifications of the Contract;
 - ii. Providing work or material was not awarded under the Contract;
 - iii. Failing to adequately perform the services set forth in the scope of work and specifications;
 - iv. Failing to complete required work or furnish required materials within a reasonable amount of time;

- v. Failing to make progress in performance of the Contract or giving Region 4 ESC reason to believe Contractor will not or cannot perform the requirements of the Contract; or
- vi. Performing work or providing services under the Contract prior to receiving an authorized purchase order.

Upon receipt of a written deficiency notice, Contractor shall have ten (10) days to provide a satisfactory response to Region 4 ESC. Failure to adequately address all issues of concern may result in Contract cancellation. Upon cancellation under this paragraph, all goods, materials, work, documents, data and reports prepared by Contractor under the Contract shall immediately become the property of Region 4 ESC.

- b) Termination for Cause. If, for any reason, Contractor fails to fulfill its obligation in a timely manner, or Contractor violates any of the covenants, agreements, or stipulations of this Contract Region 4 ESC reserves the right to terminate the Contract immediately and pursue all other applicable remedies afforded by law. Such termination shall be effective by delivery of notice, to the Contractor, specifying the effective date of termination. In such event, all documents, data, studies, surveys, drawings, maps, models and reports prepared by Contractor will become the property of the Region 4 ESC. If such event does occur, Contractor will be entitled to receive just and equitable compensation for the satisfactory work completed on such documents.
- c) Delivery/Service Failures. Failure to deliver goods or services within the time specified, or within a reasonable time period as interpreted by the purchasing agent or failure to make replacements or corrections of rejected articles/services when so requested shall constitute grounds for the Contract to be terminated. In the event Region 4 ESC must purchase in an open market, Contractor agrees to reimburse Region 4 ESC, within a reasonable time period, for all expenses incurred.
- d) Force Majeure. If by reason of Force Majeure, either party hereto shall be rendered unable wholly or in part to carry out its obligations under this Agreement then such party shall give notice and full particulars of Force Majeure in writing to the other party within a reasonable time after occurrence of the event or cause relied upon, and the obligation of the party giving such notice, so far as it is affected by such Force Majeure, shall be suspended during the continuance of the inability then claimed, except as hereinafter provided, but for no longer period, and such party shall endeavor to remove or overcome such inability with all reasonable dispatch.

The term Force Majeure as employed herein, shall mean acts of God, strikes, lockouts, or other industrial disturbances, act of public enemy, orders of any kind of government of the United States or the State of Texas or any civil or military authority; insurrections; riots; epidemics; landslides; lighting; earthquake; fires; hurricanes; storms; floods; washouts; droughts; arrests; restraint of government and people; civil disturbances; explosions, breakage or accidents to machinery, pipelines or canals, or other causes not reasonably within the control of the party claiming such inability. It is understood and agreed that the settlement of strikes and lockouts shall be entirely within the discretion of the party having the difficulty, and that the above requirement that any Force Majeure shall be remedied with all reasonable dispatch shall not require the settlement of strikes and lockouts by acceding to the demands of the opposing party or parties when such settlement is unfavorable in the judgment of the party having the difficulty.

- e) Standard Cancellation. Region 4 ESC may cancel this Contract in whole or in part by providing written notice. The cancellation will take effect 30 business days after the other party receives the notice of cancellation. After the 30th business day all work will cease following completion of final purchase order.

- 12) Licenses. Contractor shall maintain in current status all federal, state and local licenses, bonds and permits required for the operation of the business conducted by Contractor. Contractor

CONTRACT

shall remain fully informed of and in compliance with all ordinances and regulations pertaining to the lawful provision of services under the Contract. Region 4 ESC reserves the right to stop work and/or cancel the Contract if Contractor's license(s) expire, lapse, are suspended or terminated.

- 13) Survival Clause. All applicable software license agreements, warranties or service agreements that are entered into between Contractor and Region 4 ESC under the terms and conditions of the Contract shall survive the expiration or termination of the Contract. All Purchase Orders issued and accepted by Contractor shall survive expiration or termination of the Contract.
- 14) Delivery. Conforming product shall be shipped within 7 days of receipt of Purchase Order. If delivery is not or cannot be made within this time period, the Contractor must receive authorization for the delayed delivery. The order may be canceled if the estimated shipping time is not acceptable. All deliveries shall be freight prepaid, F.O.B. Destination and shall be included in all pricing offered unless otherwise clearly stated in writing.
- 15) Inspection & Acceptance. If defective or incorrect material is delivered, Region 4 ESC may make the determination to return the material to the Contractor at no cost to Region 4 ESC. The Contractor agrees to pay all shipping costs for the return shipment. Contractor shall be responsible for arranging the return of the defective or incorrect material.
- 16) Payments. Payment shall be made after satisfactory performance, in accordance with all provisions thereof, and upon receipt of a properly completed invoice.
- 17) Price Adjustments. Should it become necessary or proper during the term of this Contract to make any change in design or any alterations that will increase price, Region 4 ESC must be notified immediately. Price increases must be approved by Region 4 ESC and no payment for additional materials or services, beyond the amount stipulated in the Contract shall be paid without prior approval. All price increases must be supported by manufacturer documentation, or a formal cost justification letter. Contractor must honor previous prices for thirty (30) days after approval and written notification from Region 4 ESC. It is the Contractor's responsibility to keep all pricing up to date and on file with Region 4 ESC. All price changes must be provided to Region 4 ESC, using the same format as was provided and accepted in the Contractor's proposal.

Price reductions may be offered at any time during Contract. Special, time-limited reductions are permissible under the following conditions: 1) reduction is available to all users equally; 2) reduction is for a specific period, normally not less than thirty (30) days; and 3) original price is not exceeded after the time-limit. Contractor shall offer Region 4 ESC any published price reduction during the Contract term.

- 18) Audit Rights. Contractor shall, at its sole expense, maintain appropriate due diligence of all purchases made by Region 4 ESC and any entity that utilizes this Contract. Region 4 ESC reserves the right to audit the accounting for a period of three (3) years from the time such purchases are made. This audit right shall survive termination of this Agreement for a period of one (1) year from the effective date of termination. Region 4 ESC shall have the authority to conduct random audits of Contractor's pricing at Region 4 ESC's sole cost and expense. Notwithstanding the foregoing, in the event that Region 4 ESC is made aware of any pricing being offered that is materially inconsistent with the pricing under this agreement, Region 4 ESC shall have the ability to conduct an extensive audit of Contractor's pricing at Contractor's

sole cost and expense. Region 4 ESC may conduct the audit internally or may engage a third-party auditing firm. In the event of an audit, the requested materials shall be provided in the format and at the location designated by Region 4 ESC.

- 19) Discontinued Products. If a product or model is discontinued by the manufacturer, Contractor may substitute a new product or model if the replacement product meets or exceeds the specifications and performance of the discontinued model and if the discount is the same or greater than the discontinued model.
- 20) New Products/Services. New products and/or services that meet the scope of work may be added to the Contract. Pricing shall be equivalent to the percentage discount for other products. Contractor may replace or add product lines if the line is replacing or supplementing products, is equal or superior to the original products, is discounted similarly or greater than the original discount, and if the products meet the requirements of the Contract. No products and/or services may be added to avoid competitive procurement requirements. Region 4 ESC may require additions to be submitted with documentation from Members demonstrating an interest in, or a potential requirement for, the new product or service. Region 4 ESC may reject any additions without cause.
- 21) Options. Optional equipment for products under Contract may be added to the Contract at the time they become available under the following conditions: 1) the option is priced at a discount similar to other options; 2) the option is an enhancement to the unit that improves performance or reliability.
- 22) Warranty Conditions. All supplies, equipment and services shall include manufacturer's minimum standard warranty and one (1) year labor warranty unless otherwise agreed to in writing.
- 23) Site Cleanup. Contractor shall clean up and remove all debris and rubbish resulting from their work as required or directed. Upon completion of the work, the premises shall be left in good repair and an orderly, neat, clean, safe and unobstructed condition.
- 24) Site Preparation. Contractor shall not begin a project for which the site has not been prepared, unless Contractor does the preparation work at no cost, or until Region 4 ESC includes the cost of site preparation in a purchase order. Site preparation includes, but is not limited to: moving furniture, installing wiring for networks or power, and similar pre-installation requirements.
- 25) Registered Sex Offender Restrictions. For work to be performed at schools, Contractor agrees no employee or employee of a subcontractor who has been adjudicated to be a registered sex offender will perform work at any time when students are or are reasonably expected to be present. Contractor agrees a violation of this condition shall be considered a material breach and may result in the cancellation of the purchase order at Region 4 ESC's discretion. Contractor must identify any additional costs associated with compliance of this term. If no costs are specified, compliance with this term will be provided at no additional charge.
- 26) Safety measures. Contractor shall take all reasonable precautions for the safety of employees on the worksite and shall erect and properly maintain all necessary safeguards for protection of workers and the public. Contractor shall post warning signs against all hazards created by its operation and work in progress. Proper precautions shall be taken pursuant to state law

and standard practices to protect workers, general public and existing structures from injury or damage.

- 27) Smoking. Persons working under the Contract shall adhere to local smoking policies. Smoking will only be permitted in posted areas or off premises.
- 28) Stored materials. Upon prior written agreement between the Contractor and Region 4 ESC, payment may be made for materials not incorporated in the work but delivered and suitably stored at the site or some other location, for installation at a later date. An inventory of the stored materials must be provided to Region 4 ESC prior to payment. Such materials must be stored and protected in a secure location and be insured for their full value by the Contractor against loss and damage. Contractor agrees to provide proof of coverage and additionally insured upon request. Additionally, if stored offsite, the materials must also be clearly identified as property of Region 4 ESC and be separated from other materials. Region 4 ESC must be allowed reasonable opportunity to inspect and take inventory of stored materials, on or offsite, as necessary. Until final acceptance by Region 4 ESC, it shall be the Contractor's responsibility to protect all materials and equipment. Contractor warrants and guarantees that title for all work, materials and equipment shall pass to Region 4 ESC upon final acceptance.
- 29) Funding Out Clause. A Contract for the acquisition, including lease, of real or personal property is a commitment of Region 4 ESC's current revenue only. Region 4 ESC retains the right to terminate the Contract at the expiration of each budget period during the term of the Contract and is conditioned on a best effort attempt by Region 4 ESC to obtain appropriate funds for payment of the contract.
- 30) Indemnity. Contractor shall protect, indemnify, and hold harmless both Region 4 ESC and its administrators, employees and agents against all claims, damages, losses and expenses arising out of or resulting from the actions of the Contractor, Contractor employees or subcontractors in the preparation of the solicitation and the later execution of the Contract. Any litigation involving either Region 4 ESC, its administrators and employees and agents will be in Harris County, Texas.
- 31) Marketing. Contractor agrees to allow Region 4 ESC to use their name and logo within website, marketing materials and advertisement. Any use of Region 4 ESC name and logo or any form of publicity, inclusive of press releases, regarding this Contract by Contractor must have prior approval from Region 4 ESC.
- 32) Certificates of Insurance. Certificates of insurance shall be delivered to the Region 4 ESC prior to commencement of work. The Contractor shall give Region 4 ESC a minimum of ten (10) days' notice prior to any modifications or cancellation of policies. The Contractor shall require all subcontractors performing any work to maintain coverage as specified.
- 33) Legal Obligations. It is Contractor's responsibility to be aware of and comply with all local, state, and federal laws governing the sale of products/services and shall comply with all laws while fulfilling the Contract. Applicable laws and regulation must be followed even if not specifically identified herein.

OFFER AND CONTRACT SIGNATURE FORM

The undersigned hereby offers and, if awarded, agrees to furnish goods and/or services in strict compliance with the terms, specifications and conditions at the prices proposed within response unless noted in writing.

Company Name School Health Corporation

Address 5600 Apollo Drive

City/State/Zip Rolling Meadows, IL 60008

Telephone No. 866-323-5465

Email Address bids@schoolhealth.com

Printed Name Andrew Wlezen

Title Contract Sales Supervisor

Authorized signature *Andrew Wlezen*

Accepted by Region 4 ESC:

Contract No. R201104

Initial Contract Term October 1, 2020 to September 30, 2023

Margaret S. Bass
Region 4 ESC Authorized Board Member

8/25/2020
Date

Margaret S. Bass
Print Name

Linda Tinnerman
Region 4 ESC Authorized Board Member

8/25/2020
Date

Linda Tinnerman
Print Name

Palos Sports

School Health Corporation

2020

200+ NEW ITEMS!



FREE SHIPPING
ON ORDERS OVER \$125*

SEE PAGE 1 FOR DETAILS

PROVIDING YOU THE TOOLS FOR A HEALTHY FITNESS LIFESTYLE

A NOTE FROM THE PRESIDENT

To Our Valued Customers, my name is Rob Rogers and I am the President of School Health Corporation. School Health acquired Palos Sports in 2017 and we've been working to support Palos as the newest member of the School Health family. Since our founding in 1957, School Health has been committed to supporting the health—physically, mentally and emotionally—of students so that all can learn and perform to the best of their abilities. Dan Dunne will continue in his role as the President of Palos Sports – and we are thrilled that our School Health family can now support physical education through Palos.

We are very excited to bring you our 2020 Physical Education catalog, featuring over 250 new and innovative products. Be sure to check out BRAINball™ on page 332 – it provides the perfect blend of physical fitness and academic learning.

As we pledge our continued support to PE programs and their students, we are proud to expand our sponsorship with the Special Olympics. We are currently providing young athletes with equipment in 20 states, and we plan to expand internationally. We are also expanding our sponsored workshops to have a nationwide presence – allowing us to share our passion for PE across the country.



**SINCERELY,
ROB ROGERS, SCHOOL HEALTH PRESIDENT**



THE PALOS SPORTS PROMISE

CUSTOMER CARE

We set the bar when it comes to customer service by making you **our #1 priority**. Call us M-F 8:00 AM to 5:00 PM CST.

LOW PRICES

We'll work with you to make sure you're getting the **greatest bang for your buck!**

FAST SHIPPING

Get your equipment fast! Orders received by 1:00 PM CST will **ship that day**.

GUARANTEE

Buy with confidence! Palos Sports offers a one year **MONEY BACK GUARANTEE!**

P: 800-233-5484

F: 877-800-5973

PalosSports.com



CHOOSE FROM FOAM OR VINYL BALLS

ZONE Weighted Target Bowling Sets

A 9" tall, narrower, colorful alternative to the traditional white pin.

Made with a durable foam rubber cover and a weighted base to prevent tipping, The Zone targets add a new twist to bowling. Use for relays and targetting games as well. Foam Ball Set includes: Ruffskin Foam Bowling Balls (set of 6), Targets (10 sets of 6 - 60 total). Ruffskin balls are made with a durable polyurethane cover. Vinyl Ball Set includes: Zone 3 lb. Vinyl Bowling Balls (6), Targets (10 sets of 6 - 60 total). Zone Vinyl balls are seamless, one piece construction with 2 sets of holes for a variety of hand sizes.

66794 Foam Ball Set - Set of 6 Ruffskin Bowling Balls & 10 sets of targets **\$339.99 set**

66795 Vinyl Ball Set - Six 3 lb. Electric Lime/Yellow Balls & 10 sets of targets **499.99 set**



ZONE POWRGRIP Footballs

Unsurpassed grip for greater control and enhanced accuracy.

This construction offers a far superior tactile experience in the hand than any generic rubber football. The high quality wound bladder improves air retention and shape.

50442 SET OF 6 Youth 12-14 **79.99 set**

50448 SET OF 6 Junior 10-12 **79.99 set**



Cannon Launcher

Stomp on the launcher and watch the ball fly with great velocity!

Made from heavy duty vinyl, the launcher works with most 3" foam balls. Launchers measure 5"H x 9.5"W. Set includes 6 launchers and 36 foam balls.

16178 SET OF 6 **\$159.99 set**

17414 Single Canon Launcher **32.99 ea.**



ZONE FlipZ

So many uses, you'll flip!

FlipZ have a unique design and colors which make them versatile and an exceptional value for any group program. Teams can compete to flip the most of their color on top in a set time. Try a new spin on catch-a-ball with partners. Also great for pyramid stacking, relays and as ball holders. Made from safe and durable foam rubber. Set of 24.

17206 **\$139.99 SALE \$114.97 set**

FREE LESSON PLANS FOR PE TEACHERS!



We've created an online resource that features innovative lesson plans with great visual aids and equipment lists right at your finger tips. Enjoy these FREE lesson plans at

PEwithPalos.com

SHOP OUR BRANDS
TOP QUALITY AT GREAT PRICES

PALOS

**SPORTS
HEALTH**

**THE
ZONE**

WE'VE WORKED HARD TO PERFECT THE PALOS BRANDS.
100% SATISFACTION IS GUARANTEED!

CALL US TODAY. WE'D LOVE TO HEAR FROM YOU! 1-800-233-5484

TABLE OF CONTENTS

Active Furniture	329	Broomball	87	First Aid	292	Martial Arts & Boxing.	254	Scrimmage Vests	118
Adaptive PE Equipment	129	Canopies	81	Fitness Assessment	284	Mats	344	Soccer	58
Agility	262	Chairs	328	Fitness Equipment	226	Megaphones	302	Speed Stacks	167
Archery	176	Circuit Training	278	Flag Football	56	Nutrition	330	Standards	48
Audio	312	Classroom Activities	334	Floor Hockey	87	Order Form	356	Stopwatches	316
Awards	320	Climbing	337	Flooring	255	Paddle Games	214	Swimming & Water Polo	290
Badminton	218	Coaches' Aids	300	Foam Balls	98	Parachutes	186	Table Tennis	210
Balance/Movement	199	Cones & Markers	121	Football	52	Pedometers	283	Teacher Resources	332
Ball Bags & Carts	304	CPR	297	Games & Activities	134	Pickleball	218	Team Building	148
Baseball/Softball	69	Dance	173	Golf	206	Pinnies & Vests	116	Tennis	222
Basketball	24	Discs & Disc Golf	170	Gymnastics	342	Playballs	98	Tetherball	325
Bean Bags	160	Dodgeballs	99	Heart Rate Monitors	282	Playground Equipment	324	Terms/Shipping	355
Bleachers & Benches	326	Electronics	312	Hoops	188	Racquetball	225	Timers	315
Board Games	169	Equipment Carriers	304	Hydration	298	Resistance Training	227	Toss Games	146
Books	337	Equipment Packs	11	Inflators	311	Rhythmic Play	179	Track & Field	78
Bosu Training	258	Exergaming	281	Juggling	205	Ride Ons	198	Volleyball	38
Bowling	190	Field Day	158	Jump Ropes	180	Scales	287	Wall Mats	353
BRAINball	331	Field Hockey	87	Lacrosse	84	Scoters	194	Whistles & Lanyards	300
		Field Markers	303	Locks	289	Scoreboards	318	Yoga	272

FREE SHIPPING ON ORDERS OVER \$125*

*Free shipping applies to non-prefix items only. Items beginning with an 'X', 'T' or 'C' prefix will incur shipping charges. Free shipping discount cannot be combined with any other offer or sale. Please see page 355 for complete shipping details.

SEE BACK COVER FOR DISCOUNT CODE

SALE
**OVER 600
ITEMS
ON SALE!**



TARGET OPTIONS

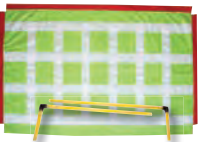

Target mat & Crossbar
Secure to crossbar and tall posts



Target Mat Only
Hang your own targets



ZONE POWRBase
Single bolt system locks posts in place

SEE PAGE 136 FOR ADDITIONAL ACCESSORIES.



Tall Side Post
Adjusts from 61" - 95"H



Crossbar Only
Support for target mat. 8.3' L

Swivel Joint Connector
Connect multiple systems at angles

ZONE Dual Sided Target Mat System

The most value and action packed gaming system in the industry. Limited only by the imagination, the Target Mat is a dual-sided, Velcro® lined mat designed to add excitement, value, and versatility to PE and adapted physical education programs. Apply various cloth targets to the mat and use accessories such as Cannon Launchers, Cannon Cubes, Target Balls, and more to play fun group and relay games. Use the optional Crossbar to secure multiple mats side-by-side to create an affordable gym divider. Create angled mat configurations using the optional Swivel Connector. Use the mat alone to play no-peek volleyball. Dimensions: 8.25"W x 5'H.



Swivel Joint Connector
ALLOWS YOU TO CONNECT MULTIPLE SYSTEMS AT VARIOUS ANGLES



Choose the right package for your class!

- X30257 Super Deluxe Set: Target Mat, Crossbar, 2 POWRBases, 2 Tall Posts, 1 set ea. of - Alien Targets, Bullseye Targets, Sticky Cannon Cubes, Target Ball \$699.99 set
- X30256 Deluxe Set: Target Mat, Crossbar, 1 set ea. of - Alien Targets, Bullseye Targets, Sticky Cannon Cubes, Target Balls \$449.99 set
- X30255 Target Mat & Crossbar \$159.99 set
- 30252 Target Mat (only) \$99.99 ea.
- X30242 Zone POWRBase: Single bolt system locks posts in place \$79.99 ea.
- X30243 Tall Side Post (60" - 95"): Locking system adjusts from 61" - 95"H \$64.99 ea.
- X30253 Crossbar (only) 8.3'L: Support for target mat. 8.3' L \$49.99 ea.
- 30260 Swivel Joint Connector: Connect multiple systems at angles \$14.95 ea.



ZONE Duffel Bag

A mesh/canvas combo for easily identifying equipment.

This bag can hold at least (40) 8" rubber balls.

It is made of canvas with a vinyl backing for strength and a strong porthole mesh middle section. Features include a drawstring top and heavy duty shoulder strap. Measures 42"L x 20"W.

- 36288 SET OF 6 \$89.99 set
- 36270 Single Red/Black Bag \$15.99 ea.



ZONE FlipZ

So many uses, you'll flip!

FlipZ have a unique design and colors which make them versatile and an exceptional value for any group program. Teams can compete to flip the most of their color on top in a set time. Try a new spin on catch-a-ball with partners. Also great for pyramid stacking, relays and as ball holders. Made from safe and durable foam rubber. Set of 24.

- 17206 \$139.99 **SALE \$114.97 set**



NEW & IMPROVED DESIGN!



ZONE Cannon Launchers

So much fun, no one can resist stomping!

Launchers are one of the most exciting and innovative products in the PE market. Students place one of the included foam balls, or optional soft cubes, into the mouth of the device. He or she then gives it their best stomp and watches in awe as it goes flying through the air towards the intended goal. The ZONE Launchers are perfect for group games or field days. They go especially well with The ZONE Target Mat System. Find exciting game ideas at pewithpalos.com. Measures: 9.5"W x 5"H. Choose from a set of 6 or single launcher. Includes foam balls.

- 16178 Set of 6 w/ 36 Foam Balls \$159.99 set
- 17414 Single Launcher w/6 Foam Balls, Assorted Colors 32.99 ea.



ZONE Cannon Cubes

Choose from Sticky Velcro® or regular cubes.

Soft, polyester filled cubes are designed to fit into Cannon Launchers, and are also safe to toss. Sticky Cubes have Velcro® on the sides and will stick to all ZONE Targets sets. Includes 12 cubes: 2 of each color. Measures: 3" x 3" x 3".

- 26013 Standard Cubes Set of 12 \$29.99 set
- 17249 Sticky Cubes Set of 12 45.99 set



ZONE Hidden Spots

Flip them over to reveal the secret color.

These double sided vinyl spots are perfect for matching games and more. Each colored spot has a random color on the opposite side. Partners take turns tossing a ball to each other. The thrower looks at the color underneath after they toss the ball and then moves to a spot of that color. Play is repeated until time runs out. Vary gameplay by using soccer balls, rings and more. Work individually or in pairs. 10" dia.



- 21213 \$119.99 SALE \$99.97 set



USE V2 OPEN NET FOR SOCCER OR FLOOR HOCKEY

REMOVABLE COVER



AVAILABLE IN A 20" OR 40" DIAMETER

ADJUSTS TO 4 HEIGHTS



ZONE Adjustable Height Round Base Goal

Customizable goal available in 40" full-size and 20" compact versions!

Both models come with a closed bottom net. Use as a large shooting goal or for 360° soccer/ floor hockey. Place sideways for use as a traditional goal. Adjustable heights: 28", 30", 35" and 40".

Additional options include:

- V2 Open Bottom Net (40" goal only) - Allows goals to be scored from the side without rebounding back. Create obstacle courses when tipped on its side allowing students to pass through the goal.
- Round Base Goal Ring Covers - Simple nylon fabric covers stretch over the goals top ring to convert them into unique colored goals. Set of 6 colors. Two sizes: 20" dia or 40" dia.

17190 40" Adjustable Goal	\$129.99 ea.	17189 40" V2 Open Net	49.99 ea.
17278 20" Adjustable Goal	99.99 ea.	66829 SET OF 6 40" Adjustable Goal w/ Ring Covers NEW	749.99 set
18250 SET OF 6 40" Ring Covers	59.99 set	66830 SET OF 6 20" Adjustable Goal w/ Ring Covers NEW	599.99 set
17279 SET OF 6 20" Ring Covers	39.99 set		



ZONE DodgeDISC

A softer and lighter alternative to the DodgeBee® Disk

Use as a non-threatening substitute to hard disks. Also great for catch and target games. Constructed of a durable nylon cover with foam inserts.

DodgeDISC game instructions included. 10" diameter. Color may vary.

17242 Single, Assorted Colors	\$13.99 SALE \$9.97 ea.
17368 SET OF 6	69.99 SALE 54.97 set



NEW

Thermo Grip Playballs

Covers change color right in the palm of your hand.

Rhino Skin® coating for exceptional tear-resistance. The thermo enhanced covers are activated by body heat. They are sting-resistant, low-density and have a low-bounce foam core and soft exterior. Measures 6.3" in diameter.

10600 Set of 6	\$83.99 set
----------------------	-------------

THE ZONE POWRBASE Multi-Purpose Base System



SEE PAGE 49 FOR ADDITIONAL ACCESSORIES



SWIVEL JOINT

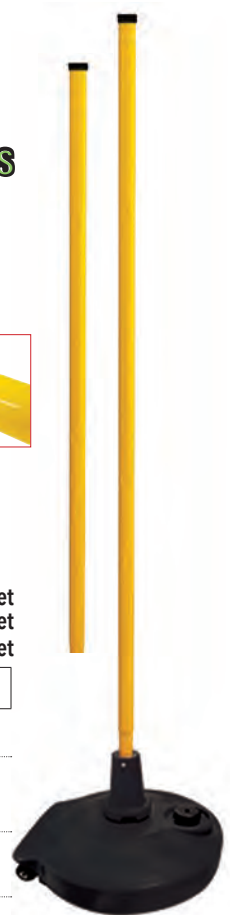

ZONE POWRBASE Multipurpose Standard System

A unique, build-your-own system designed to fit your needs.

The POWRBase system features individual components that can be combined for numerous activities such as regular and no-peek volleyball, badminton, Net Ball and tetherball. Build single or multi-angled target walls with the optional crossbars and swivel joint. Connect multiple Zone target mats (see pg. 136) together to create an affordable gym divider. Available options include:

- X30247 2 Bases, 2 Tall Posts, 1 Lightweight Net \$279.99 set
- X30248 2 Bases, 2 Short Posts, 1 Lightweight Net \$265.99 set
- X30250 Complete System: 2 Bases, 2 Tall Posts, 2 Short Posts, 1 Lightweight Net \$319.99 set

Item #	Name	Description	Price
30244	Lightweight Net	Measures 20'L x 23"W. Remains square and taut	\$39.99 ea.
30242	Individual POWRBase	Tip N' Roll design. Made of durable PVC. Can be filled with water, sand or pea gravel. Single bolt system locks posts in place.	79.99 ea.
30240	Base and Short Post	Ideal for tennis up to badminton heights. Adjusts from 41" - 66"H.	129.99 set
30245	Base and Tall Post	Features a push pin locking system with pre-marked holes for men's, women's and junior's volleyball, and badminton heights. Adjusts from 61" - 95"H.	129.99 set
30260	Swivel Joint	Allows two crossbar systems to be connected and placed at multiple angles.	14.95 ea.



Tchoukball

Fast moving sport blending skill and strategy!

The object of the game is to score points for your team by throwing the ball at the net in such a way the opposing team cannot catch the rebound. Teams rely on quick passes to move the ball down the court before taking their shot at the net-there's no blocking or interference. Dropped passes result in a change of possession. Can adapt to many class sizes for indoor or outdoor play. Both sets include two 39" square super taut angled nets, 1 Tchoukball (middle school uses size 1 ball and high school uses size 2 ball) and rules of the game..

- X15900 Middle School Set \$449.99 **SALE \$349.97 set**
- X15979 High School Set \$449.99 **SALE \$349.97 set**
- X15953 Nets only, 39" x 39", 20 lbs. \$399.99 **SALE \$299.97 pr.**



ZONE BOUNDER BALL

A fast paced rebounding game with a twist.

Teams score by throwing a 6" diameter ball into the center pocket surrounded by a rebounding panel. Missed shots bounce back into place helping to improve reaction times. Vary gameplay with rules similar to Ultimate Frisbee or Tchoukball. Includes 2 adjustable angle, heavy-duty steel goals and (3) size 1 game balls - POWRGRIP Tchoukball, ZONE Tchoukball, and RUFFSKIN Foam Handball. Frame measures 40"L x 39.5"W.

- X54291 Bouncer BALL Full Set \$349.99 set
- X54289 Goal Pair Only \$319.99 set

THE ZONE POWER PRO PREMIUM GOALS

FEATURES*

- USE INDOORS OR OUT
- FAST AND EASY ASSEMBLY
- JOINTS WITHSTAND UP TO 200 LBS.
- SUPER DURABLE NETTING

*Features vary by model

STRONG REINFORCED CORNERS

STEEL CROSSBAR

TWIST TIGHT JOINTS





STEEL FRAME

THE ZONE POWER PRO

Pro Series Soccer/Hockey Goal

Go from soccer to hockey with a simple change of the net!

Maximize your budget with this versatile, indoor or outdoor goal. Choose from the Soccer/Hockey package that includes two nets, or the single net soccer goal. Made of heavy-duty 1.25" diameter steel frame, reinforced PVC corner joints and twist tight connectors. 6'L x 51"H x 36"D.

- 54282 Soccer Goal, Braided 4" Mesh Net Only \$110.99 **SALE \$89.97 ea.**
- 54290 Soccer/Hockey, 1 Frame, 2 Nets 126.99 **SALE 99.97 ea.**
- 54287 The Zone Twisted 1.75" sq. Mesh Net (Fits 54282) 14.99 ea.

HOCKEY NET SOCCER NET

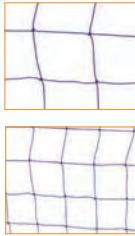

THE ZONE POWER PRO 3 in 1 Training Goal/Rebound Set

Train like a pro with 3 different setups!

This set features a 4" sq. soccer net for pro style training and game play, a rebounder net to improve ball control, and a target to develop shooting accuracy. Easy bungee net attachment system. 2" PVC frame. Includes 8" soccer ball, hand-pump, needle and 6 metal stakes. Measures 6'L x 51"H x 36"D.

- 54285 \$129.99 set



THE ZONE POWER PRO

Junior Soccer Goal Set

A smaller version for youth play that is super fast and easy to assemble!

Includes everything you need to train or play small sided games. Includes 2 PVC goals, 6" soccer ball, hand pump, needle, and 8 ground stakes. Use goals indoors or outside. Measures 30"L x 24"H x 18"D.

- 54286 \$39.99 pr.



STEEL FRAME

THE ZONE POWER PRO

Pro Series 2 in 1 Goal

Excellent practice goal for soccer or floor hockey! Premium reinforced PVC corners will not blemish gym floors making this goal ideal for outdoors and well as inside. Durable 1.25" diameter steel frame. Includes a braided 2" sq. mesh net with easy-on hooks and 4 metal stakes. Measures 42"L x 36"H x 24"D.

- 54283 \$64.99 ea.
- 66779 Pair of Goals 124.99 pr.



STEEL FRAME

THE ZONE POWER PRO

Pro Series 8ft Soccer Goal

Designed with reinforced PVC corners and joints! Great for outdoors as well as inside. Will not mar gym floors. Frame is made of 1.25" diameter, powder coated steel, and sturdy twist-tight connectors. Includes a twisted 4" sq. mesh net with easy-on hooks and 9 metal stakes. Measures 8'L x 6'H x 42"D.

- 54281 \$124.99 **SALE \$104.97 ea.**

BRAINball™ A PHYSICAL EDUCATION CROSS CURRICULAR SYSTEM

"Learning through play."



WHAT YOU GET...

A SET OF 100 BALLS WITH LETTERS, NUMBERS AND SYMBOLS AND 100 LESSON PLANS THAT ARE EASY TO TEACH AND LEARN



What is BRAINball™?

BRAINball™ is an innovative and unique physical education learning system that merges physical activity and academic learning through play. Instructors and students use 100 mini soccer and basketballs and 100 lesson plans to develop math, reading, grammar, spelling, anatomy and foreign language skills. In addition to the physical benefits, significant improvement will be seen in gross and fine motor skills, cooperative and cognitive learning. BRAINball™ can be incorporated into Adapted Physical Education programs as well as those teaching students with learning disabilities, such as dyslexia.

BRAINball™ is broadly adaptable across elementary and secondary grades, and while an excellent tool for physical education, it is also perfect for use in the classroom, after-school, recreation and sports programs.

Why use BRAINball™?

Developed by the University School of Physical Education, Wroclaw, Poland in 2002, BRAINball™ has almost two decades of proven research published in numerous books, research publications, and doctoral dissertations. See our website for more information. Ask us how to set up a professional development workshop at your school.

What does BRAINball™ include?

Each set includes a lesson book filled with 100 games/activities, 100 mini basketballs and soccer balls (size 3) in five colors – red, orange, yellow, blue and green – and premium equipment bags with carry strap. There are 40 yellow and 40 green basketballs with letters (upper & lower case) and numbers, 8 red and 8 blue soccer balls with math symbols, and 4 orange "wild card" (blank) balls. BRAINball™ book is not sold individually.

49082 BRAINball™ Set - 100 balls and 100 lesson plans. \$789.99 set



ZONE Alien Spaceship Battle

Which team will be the first to stop the alien invasion?

Teams place their ships randomly on their side of the court. The weighted alien targets are placed on each spaceship. Teams toss foam balls, or flying discs, at the opposing targets. First team to knock them all over wins. Use targets and ships for a fun spin on bowling. Find multiple game variations at pewithpalos.com. Each set includes: 17 green aliens, 17 orange UFO's, 5 orange UFO's.

- 17228 Alien Spaceship Battle - 34 Alien Targets & 10 UFO Bases \$164.99 set
- 66824 Alien Spaceship Battle & (18) 5.5" Easy Grip Foam Balls..... 299.99 set



ZONE Flying Saucer Face Off

An exciting spin on the original Alien Spaceship Battle.

Gameplay is similar to the rules of Alien Spaceship Battle. However, additional strategy is needed. Teams arrange their ships and targets on their side of the court. Soft ZONE DodgeDISCS are placed on the baselines. At the signal, students launch their flying saucers (discs) at the opposing alien targets. The first team to knock them all over wins. Game includes 34 weighted alien targets, 10 foam UFO bases and 18 DodgeDISCS - 3 sets of 6.

- 66825 \$359.99 set



ZONE Weighted Knock Down Targets

Add more fun to any game... the uses are endless.

These 9" targets have a durable, textured foam rubber cover, with a weighted base to prevent easy tipping. Use as station markers or replacements for cones during races. They make exciting alternatives to traditional bowling pins or relay batons. Set them up and then knock them down.

- 17227 SET OF 6 \$38.99 SALE \$27.97 set

NEW

Golf Bocce

Practice your chipping skills while competing in a fun bocce themed game.

Played with rules similar to bocce ball, players take turns chipping their larger fleece balls towards the smaller Short Flyte ball (or jack). Play continues until one team reaches a score of 11. Includes: The ZONE 7 Irons - set of 6, 3" premium fleece balls - 2 sets of 6, Short Flyte practice golf balls - set of 4.

- 66793 \$54.99 set



ZONE Ice Cream Scoop Relay

We all scream for ice cream!

Each team has one of six colored foam ice cream scoops. The goal is to be the first team to collect all six colors of ice cream scoops. Includes 6 ice cream cones and 36 ice cream scoops.

- 17204 \$89.99 set



ZONE Soft Touch No Sting Volleyball

Ideal recreation and practice ball!

A combination of soft neoprene and honeycomb textured panels creates superior grip and takes the sting out of hits. Incredibly lightweight and durable bladder. Two-tone, 18 panel cover. 8.5"D. Set of 6.

- 33621 SET OF 6 \$69.99 SALE \$59.97 set



NEW

ZONE Fast Food Foolery

Introduce proper nutrition concepts through active play. Perfect for Health and Nutrition classes, or even as a quick "brain break." Randomly chosen students begin the game holding one of the 3 included fast food components (cheeseburger, fries, drink). The remaining students try to avoid being tagged by the unhealthy food. If tagged, they must take the food component and try to get rid of it by tagging another student. Game teaches proper eating habits and spatial awareness. Includes: soft drink, loose fries/container, cheeseburger with bun and toppings. Meets national standards 1 – 5. Two or more sets recommended for large class sizes. **⚠ CHOKING HAZARD (1) - SMALL PARTS. Not for under 3 yrs.***

17370 \$19.99 set

OUR MOST POPULAR
SCOOTER | 12" or 16"
IS AVAILABLE IN 2 SIZES!



ZONE Heavy Duty 12" Scooter Set

With handles for safety!
Built tough with molded polyurethane construction. Features non-marring rubber wheels with ball bearing casters. Use connectors on page 190 for attaching scooters to each other. Sold in a set of 6 only.

17076 SET OF 6 12" \$105.99 SALE \$89.97 set
X17092 SET OF 6 16" 144.99 SALE 129.97 set



NEW

Shield® Bean Bag Puck Set

Innovative new design.
Less vibration, more control and impact absorption due to the unique fill.

39244 SET OF 6 \$23.99 set



NEW

ZONE 5 Gallon Bucket Drum Set

For classes of up to 24 students.
Heavy duty plastic buckets with handles. The red and blue buckets do not include lids. The yellow buckets come with lids.

- Components:
- (8) 5 gal. Red Buckets
 - (8) 5 gal. Blue Buckets
 - (8) 5 gal. Yellow Buckets w/ Lids
 - 16" Drumsticks – 24 pairs

66811 \$349.99 set

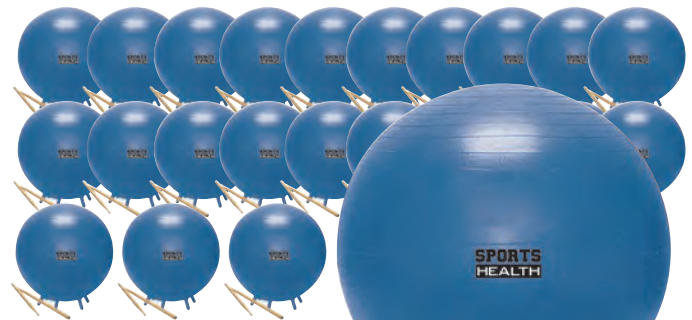

SPORTS HEALTH Fitness Ball & Stick Pack

Keep the beat and receive an amazing workout!

Create high energy classes to develop rhythm, burn calories and relieve stress. Each pack contains 24; 25" fitness balls with feet for stability, and 24 pairs of 16" long drumsticks.

66742 Ball & Stick Pack \$449.99 pk.
17230 16" Drumsticks – 6 Pairs 24.99 pk.



ZONE Exer-Dice Packs

Pair up with our 20 sided dice!
Divide classes into 6 color groups for easy warm ups and cool downs! Pack includes 6 Exer-Dice and 6 20 Sided Dice. Exer-Dice Mini pack includes: 1 Exer-Dice and 1 20 Sided Dice in assorted colors.

66701 Exer-Dice Pack- 6 of each dice \$173.50 SALE \$114.97 pk.
66735 Exer-Dice Mini Pack- 1 pair; assorted colors 24.50 SALE 21.97 pr.

*Full CHOKING HAZARD descriptions on page 355.

THE ZONE POWRGRIP™

MADE OF THE HIGHEST QUALITY CELLULAR RUBBER FOR MAXIMUM GRIP

GRIP THE DIFFERENCE



NEW

ZONE POWRGRIP™ Basketball AVAILABLE IN 4 SIZES!

Unsurpassed grip allows for more control.

Cellular Rubber cover gives this ball a superior grip and feel. High quality Japanese wound bladder for increased air retention. Perfect for beginners and skilled players alike.

37589 Official	\$14.99	SALE \$11.97 ea.
37590 Intermediate	13.99	SALE 11.50 ea.
37591 Junior	12.99	SALE 10.97 ea.
37592 Pee Wee	11.99	SALE 10.50 ea.



ZONE POWRGRIP™ Train-A-Ball Football™

Designed for both right and left hand throwers.

Using the highest quality cellular rubber for maximum grip and durability shows the user how to properly grip the football when throwing.

32353 Junior 10-12	\$14.99 ea.
--------------------------	-------------



ZONE POWRGRIP Footballs

Unsurpassed grip for greater control and enhanced accuracy.

This construction offers a far superior tactile experience in the hand than any generic rubber football. The high quality wound bladder improves air retention and shape.

50442 SET OF 6 Youth 12-14	79.99 set
50448 SET OF 6 Junior 10-12	79.99 set



ZONE POWRGRIP™ Soccer Balls

Excellent feel and durability!

Cellular Rubber construction gives balls a cushioned feel with a Japanese wound bladder for improved shape and air retention. Extremely durable for heavy use.

50443 SET OF 6 Size 5	\$79.99	SALE \$64.97 set
50444 SET OF 6 Size 4	79.99	SALE 64.97 set



NEW

ZONE POWRGRIP™ Footballs

Unsurpassed grip for greater control!

This construction offers a far superior tactile experience in the hand than any generic rubber football. The high quality wound bladder improves air retention and shape.

50446 Youth 12-14	\$13.99 ea.
50447 Junior 10-12	13.50 ea.



ZONE POWRGRIP™ Train-A-Ball Basketball

Shows proper hand placement for left and right hand shooters.

Excellent teaching aid. Cellular rubber construction for superior grip and feel.

37313 Intermediate	\$16.99 ea.
--------------------------	-------------



ZONE POWRGRIP™ Basketball

Grip the difference!

High quality Japanese wound bladder for increased air retention. Sold in sets of six in three sizes.

50439 SET OF 6 Official	\$73.99	SALE \$64.97 set
50440 SET OF 6 Intermediate	73.99	SALE 64.97 set
50441 SET OF 6 Junior	73.99	SALE 64.97 set



*Extra Large Extracurricular Activity Pack Pictured

ZONE Medium Extracurricular Activity Pack

Includes 104 pieces of equipment for up to 100 students involved in before and after school activities.

Pack includes:

- Set of 6 10452 The Zone™ PX-6 Easy Grip Balls - 6"
- Set of 6 10502 The Zone™ PX-6 Easy Grip Balls - 3"
- Set of 6 37116 Palos™ PX-200™ Rubber Basketballs Int.
- Set of 6 32042 Palos PX-200™ Rubber Footballs - Junior
- Set of 6 50171 Palos Tru-Grip Rubber Soccer Balls - Size 4
- Set of 6 10330 Rhino Soft-Eeze™ Footballs - Junior
- Set of 6 10195 Rhino Soft-Eeze™ Soccer Balls - Size 4
- Set of 6 11022 Revo Disc™ Vinyl Coated Foam Discs - 8.5"
- Set of 6 11019 POWR Discs 95 grams - 9"
- Set of 6 12073 The Zone™ Licorice Speed Ropes - 8"
- Set of 6 12074 The Zone™ Licorice Speed Ropes - 9"
- Set of 6 10530 Colored Plastic Balls - 12" Softball
- Set of 4 43233 Thrown Down Bases - Orange
- 2 ea. 24032 The Zone™ Plastic Bat - 30" Assorted Colors
- 2 sets 15493 Rubber Horseshoes - 2 bases, 12 shoes total
- Set of 6 21049 Colored Cones - 12"
- Set of 6 36116 Mesh Equipment Bags - 36" x 45"

66831 \$499.99 pk.

⚠ CHOKING HAZARD (1) - SMALL PARTS. Not for under 3 yrs.*

ZONE Large Extracurricular Activity Pack

Includes 170 pieces of equipment for up to 150 students involved in before and after school activities.

Pack Includes, Medium Activity Pack: plus

- 1 ea. 15490 24 Handle Heavy Duty Parachute - 24'
- 1 ea. 13127 Lightweight Hop Balls
- 1 ea. 21025 Standard Half Cone Class Pack - 36 cones w/ carrier
- 6 pr. 12013 Vinyl Double Dutch Rope - 16'
- 3 pr. 12011 Vinyl Double Dutch Rope - 12'
- Set of 6 10195 Rhino Soft-Eeze™ Soccer Balls - Size 4
- Set of 6 15002 The Zone™ Ball Hop
- Set of 6 36116 Mesh Equipment Bags - 36" x 45"

66832 \$849.99 pk.

⚠ CHOKING HAZARD (1) - SMALL PARTS. Not for under 3 yrs.*

ZONE Extra Large Extracurricular Activity Pack

Includes 242 pieces of equipment for up to 200 students involved in before and after school activities.

Pack Includes:, Large Activity Pack: plus

- 6 pk. 17185 Hop 66 Premium Hop Balls - 26"
- 2 ea. 43120 Easton® Rival S50 Baseball Bat - 30"/20oz
- 1 dz. X14016 Deluxe Hoops - 30"
- Set of 6 11025 POWR Discs 125 grams - 9.5"
- Set of 6 11022 Revo Disc™ Vinyl Coated Foam Discs - 8.5"
- Set of 6 16103 The Zone™ Super Flings - 32"
- Set of 6 13045 Numbered Potato Sack Set - 24"W x 27" H
- Set of 6 12073 The Zone™ Licorice Speed Ropes - 8"
- Set of 6 12074 The Zone™ Licorice Speed Ropes - 9"
- 2 pr. 66735 The Zone™ Exer-Dice Mini Packs
- 6 ea. 15550 Guate Foot Bags
- Set of 6 16220 The Zone™ ParaTossers™

66833 \$1,439.99 pk.

⚠ CHOKING HAZARD (1) - SMALL PARTS. Not for under 3 yrs.*

NEED GAME IDEAS?



VISIT PEWITHPALOS.COM FOR ACTIVITIES USING THIS EQUIPMENT & MORE!

*Full CHOKING HAZARD descriptions on page 355.



PALOS RUFFSKIN™ Dodgeball Class Pack

Our most popular dodgeball in a two color class pack!

Use the two different colors to create different variation of the game requiring cooperation and strategies. Game idea sheet included or visit our website to view games. Each class pack includes mesh storage bags.

10504 6" Black Dodgeball	\$10.50	SALE	\$9.47 ea.
10509 6" Grey Dodgeball	10.50	SALE	9.47 ea.
10461 6" Black Dodgeball set of 6	51.99	SALE	46.97 set
10462 6" Grey Dodgeball set of 6	51.99	SALE	46.97 set
66136 Small Pack-12 Dodgeballs (6-black, 6 grey)	97.99	SALE	89.97 pk.
66137 Large Pack- 24 Dodgeballs (12-black, 12 grey)	193.99	SALE	193.99 pk.



PALOS RUFFSKIN™ Neon Dodgeball Class Packs

Vivid daylight colors that glow under black light!

A great alternative ball for Team Dodgeball and more! Activity sheet included with packs or visit our website to view games. Each class pack includes mesh storage bag.

10800 6" Neon Orange Dodgeball	\$10.50 ea.
10801 6" Neon Pink Dodgeball	10.50 ea.
10559 6" Neon Orange Dodgeball Set of 6	51.99 pk.
10560 6" Neon Pink Dodgeball Set of 6	51.99 pk.
66515 Small Dodgeball Pack- includes 12 Dodgeballs (6 pink & 6 Orange)	97.99 pk.
66516 Large Dodgeball Pack- includes 24 Dodgeballs (12 pink & 12 Orange)	193.99 pk.



PALOS RUFFSKIN™ Foam Ball Starter Pack

All of our popular RuffSKIN varieties in one convenient package!

Starter Pack includes:

- 1 set 10426 6" Low-Bounce Softi
 - 1 set 10588 7" Low-Bounce Softi
 - 1 set 10589 8.25" Low-Bounce Softi
 - 1 set 10591 6" Multi-BALL
 - 1 set 10430 7" Multi-BALL
 - 1 set 10428 8.25" Multi-BALL
 - 1 set 10487 3.5" 90 High Bounce
 - 1 ea. 36270 The Zone Duffel Bag
- 66756 \$467.00 pk. **SALE \$396.97pk.**



PALOS RUFFSKIN™ 6" Dodgeball

Soft, safe and economical!

For target games, tossing activities and more! Excellent choice when you need low density for safety, yet a durable polyurethane cover for toughness.

10424 SET OF 6	\$54.99	SALE	\$44.97set
----------------------	---------	------	------------



TUFFSKIN™ Premium Ball Starter Pack

The perfect mix of our Softi and Multi-BALL vinyl coated balls!

Starter Pack includes:

- 1 ea. 10407 6.3" Low-Bounce Softi, Set of 6
- 1 ea. 17270 7" Low-Bounce Softi, Set of 6
- 1 ea. 17271 8.25" Low-Bounce Softi, Set of 6
- 1 ea. 10411 4.3" Multi-BALL, Set of 6
- 1 ea. 10416 6.3" Multi-BALL, Set of 6
- 1 ea. 10417 7" Multi-BALL, Set of 6
- 1 ea. 10406 8.25" Multi-BALL, Set of 6
- 1 ea. 36270 The Zone Duffel Bag

66755 \$627.99 pk. **SALE \$598.97 set**



Buy Packs and save!

3 YEAR GUARANTEE

PALOS TUFFSKIN™ 6.3" Traditional Dodgeball

Softness eliminates the fear of being hurt, available in white or black.

This ball can be squashed down but always bounces back to its original shape. TUFFSKIN™ toughness for durability. Add a variety of team games with the two colors.

- 10405 Black \$11.99 ea.
- 10472 White 11.99 ea.
- 66558 Black 6 Pack- 6 balls 64.99 pk.
- 66559 White 6 Pack- 6 balls 64.99 pk.
- 66403 Black Class Pack- 12 balls & bag 124.99 pk.
- 66456 White Class Pack- 12 balls & bag 124.99 pk.
- 66457 White/Black Class Pack- 12 balls, 6 of each color & bag 124.99 pk.
- 66458 White/Black Jumbo Class Pack- 24 balls, 12 of each color & bag 241.99 pk.



POWRSKIN™ Dodgeballs

The thickest coated foam ball we've got!

With a triple bonded coated layer for extra toughness, yet the same light weight feel. Each ball measures 6.3". Available in red or blue.

- 10473 6.3" Red \$13.99 ea.
- 10894 6.3" Blue 13.99 ea.
- 66459 6.3" Red 6 Pack 84.99 **SALE 74.97 pk.**
- 66774 6.3" Blue 6 Pack 84.99 **SALE 74.97 pk.**
- 63100 6.3" 6 Red and 6 Blue-12 Pack 169.90 **SALE 148.97 pk.**

4 YEAR GUARANTEE



POWRSKIN™ Dodgeballs

The thickest coated foam ball we've got!

With a triple bonded coated layer for extra toughness, yet the same light weight feel. Each ball measures 6.3". Sold in a set of six.

- 17269 SET OF 6 6.3" \$84.99 **SALE \$74.97 set**

4 YEAR GUARANTEE



PALOS TUFFSKIN™ Neon Class Pack

- 66751 12 balls, 6 of each color \$129.90 pk. **SALE \$124.97 set**

3 YEAR GUARANTEE



PALOS TUFFSKIN™ Neon Class Pack

- 66752 12 balls, 6 of each color \$129.90 pk. **SALE \$124.97 set**

3 YEAR GUARANTEE



NEW
ZONE POWERGRIP Class Packs

Each pack includes 1 set each of our premium grip basketballs, footballs and soccer balls.

High School Pack

66834 Set of 6 (ea.) - Official Size Basketball, Youth Football, Size 5 Soccer Ball . . . \$219.99 pk.

Middle School Pack

66835 Set of 6 (ea.) - Intermediate Basketball, Youth Football, Size 5 Soccer Ball . . . \$219.99 pk.

Elementary School Pack

66836 Set of 6 (ea.) - Junior Basketball, Junior Football, Size 4 Soccer Ball . . . \$219.99 pk.



PACKS INCLUDE 6 BALLS AND CARRY BAG

Basketball Packs

Each pack includes 6 rubber basketballs and a heavy duty mesh ball bag.

66702 Mikasa Premium Cover- 6 Off. sz. balls & bag . . . \$57.99 pk.

66703 Mikasa Premium Cover- 6 Int. sz. balls & bag . . . \$57.99 pk.

66704 Spalding TF-150- 6 Official size balls & bag . . . \$55.99 pk.

66705 Spalding TF-150- 6 Int. sz. balls & bag . . . \$55.99 pk.

66707 Tachikara RWB Basketballs Off. Sz. balls & bag . . . \$52.99 pk.

66777 Tachikara RWB Basketballs Int. Sz. balls & bag . . . \$50.99 pk.

66745 Wilson NCAA MVP 6 Off. Sz. balls & bag . . . \$58.99 pk.

66746 Wilson NCAA MVP 6 Int. Sz. balls & bag . . . \$58.99 pk.



Colored Ball Class Pack

An excellent way to separate recess activities or different grades.

Each kit contains 1-rubber basketball, 1-rubber football, 1-rubber soccer ball, 1 rubber volleyball, 1-rubber 8.5" playground ball and a color coordinated matching 24" x 36" mesh bag.

SIZE	RED	ORANGE	YELLOW	GREEN	BLUE	PURPLE	PRICE
4	66238	66242	66239	66240	66241	66243	\$38.99 ea.

66378 Complete Kit- 1 set of each color . . . \$248.50 **SALE \$206.97 pk.**



Middle School PE Essential Ball Class Pack

A perfect selection of softer play type balls to help teach the proper ball skills to middle school students.

2 set (6)10424 RUFFSKIN Dodgeballs

6 ea. 37300 Size 7 Rubber Basketballs

6 ea. 37355 Soft Rubber Size 4 Footballs

6 ea. 37301 Size 6 Rubber Basketballs

6 ea. 10237 Soft Jr. Synthetic Footballs

1 set 10481 Foam TUFFSKIN Soccerballs

6 ea. 33541 White Softplay Volleyballs

3 ea. 36083 Storage Bags

66135 \$449.99 pk.



Elementary Sport Ball Class Pack

A perfect selection of synthetic covered elementary size balls to teach fundamentals or an introduction to competitive play.

6 ea. 32006 Composite Jr. Footballs

6 ea. 50177 PVC Size 4 Soccer Balls

6 ea. 33541 Wilson Soft Play Volleyballs

6 ea. 37119 Wilson Size 6 Basketballs

2 ea. 36235 Duffle Bags

66748 \$419.99 pk.



PACKS INCLUDE 24 BALLS AND DUFFLE BAG

Middle School Sport Ball Class Pack

A perfect selection of synthetic cover middle school size balls for physical education or introduction to competitive play.

6 ea. 32002 Composite Int. Footballs

6 ea. 50176 PVC Size 5 Soccer Balls

6 ea. 33008 Tachikara SV18S Volleyballs

6 ea. 37118 Wilson Official Basketballs

2 ea. 36235 Duffle Bags

66373 \$427.99 pk.



ZONE SupR-Safe Ball Sets

Soft inflatable sport balls!

Soft and safe with a slight tacky feel, this ball is great for indoor or outdoor play. Made from a foamed rubber process that is lightweight, durable and easy to inflate.

- 10066 SET OF 6 6" Soccer Ball \$36.99 **SALE \$29.97 set**
- 32122 SET OF 6 8.5" Youth Football 48.99 **SALE 36.97 set**
- 32364 SET OF 6 8.5" Youth Basketball..... 59.99 **SALE 39.97 set**
- 66776 18 Ball Pack- 18 balls & 2 mesh bags 153.90 **SALE 109.97 pk**



Elementary Playground Ball Class Pack

Includes traditional playground balls, heavy duty kickballs.

Soft play volleyballs, footballs and our playground balls.

- 1 set 10081 Dura Grip 8.5" Playground Softies
- 1 set 10220 Playground Softies
- 4 ea. 10316 8.5" WAKA Kickballs
- 2 ea. 33541 Wilson Soft Play Volleyballs
- 6 ea. 10237 Franklin Grip Rite 500 Footballs
- 2 ea. 36121 Blue Canvas Bottom Mesh Bags

66747 \$179.99 pk.



Basic After School Class Pack

Includes enough equipment to keep 100 students active with a variety of fitness games. Pack includes mesh bags for storage!

- Contents:
- 1 set (6) 10110 Heavy 8.5" Playground Balls
 - 1 set (6) 10530 12" Plastic Softballs
 - 1 set (6) 10487 3.5" TUFFSKIN Foam Balls
 - 1 set (6) 10135 Jr. Nobbie Footballs
 - 6 ea. 37501 Rubber Size 6 Basketballs
 - 1 set (6) 32041 Rubber Size 4 Basketballs
 - 1 set (6) 11019 9" Plastic Discs
 - 1 set (6) 50171 TruGrip Soccer Balls Size 4
 - 1 set (6) 12063 8" Nylon Jump Ropes
 - 1 set (6) 10998 8" FunGripper Soccerballs
 - 1 set (6) 12064 9" Nylon Jump Ropes
 - 1 set (6) 11006 Coated Foam Discs
 - 1 set 43253 Rubber Base Set
 - 1 set 15054 Rubber Horseshoe Set
 - 2 ea. 24032 30" Plastic Bats
 - 6 ea. 21027 12" Plastic Cones
 - 6 ea. 36224 36" x 45" Ultra-Mesh Storage Bags
 - 1 set (6) 10010 8.5" Playground Balls
 - 2 ea. 33072 Soft Teach Mikasa Volleyballs
 - 1 set (6) 37450 Jr. Lite Rubber Basketballs
 - 2 ea. 50177 Size 4 Soccer Ball
 - 1 ea. 47004 Electronic Whistle
 - 1 set (6) 10430 7" RUFFSKIN Foam Ball
 - 1 set (6) 21026 9" Rubber Spots
 - 4 ea. 36109 Mesh Bags
- 66150 \$399.99 ea.



Field Day Pack

Create stations to keep over 50 kids moving!

Sack races, target tosses, kickball, relay races and more! This pack has everything you need! ⚠️ CHOKING HAZARD (6) - BALLOON. Not for under 3 yrs.*

- Contents:
- 1 set 10424 RUFFSKIN Dodgeball
 - 6 ea. 13002 Potato Sacks
 - 1 dz. X14014 30" No Kink Hoops
 - 1 set 15062 Ultra Foam Batons
 - 6 ea. 21029 18" Plastic Cones
 - 1 set 11019 9" Colored Discs
 - 12 ea. 21037 Orange Half Cones
 - 1 ea. 10237 Grip-Rite Football
 - 2 ea. 10002 WAKA Kickballs
 - 1 set 15041 Colored Egg and Spoon
 - 1 set 43253 Throwdown Bases
 - 1 ea. X20003 Tug-of-War Rope
 - 1 ea. 15529 Water Balloon Sling Shot
 - 2 ea. 36121 Mesh Bags
 - 1 ea. 48102 Stopwatch
 - 10 ea. 55050 1st Place Ribbons
 - 10 ea. 55051 2nd Place Ribbons
 - 10 ea. 55052 3rd Place Ribbons

X66356 \$369.97 **SALE \$369.97 pk.**



K-5 PE Starter Class Pack

A variety of the most commonly used items in a K-5 Physical Education class. Includes mesh bags for storage. Optional rolling storage cart available.

- Contents:
- 2 set (6) 17076 12" Scooters
 - 2 ea. 17011 Scooter Storage Poles
 - 1 dz. X14013 24" No-Kink Hoops
 - 1 dz. X14014 30" No-Kink Hoops
 - 1 set (6) 12071 6' Speed Ropes
 - 2 set (6) 12072 7' Speed Ropes
 - 1 set (6) 12073 8' Speed Ropes
 - 1 set (6) 32122 TheZone SupR-Safe Footballs
 - 1 set (6) 10010 8.5" Playground Balls
 - 2 ea. 33072 Soft Teach Mikasa Volleyballs
 - 1 set (6) 37450 Jr. Lite Rubber Basketballs
 - 2 ea. 50177 Size 4 Soccer Ball
 - 1 ea. 47004 Electronic Whistle
 - 1 set (6) 10430 7" RUFFSKIN Foam Ball
 - 1 set (6) 21026 9" Rubber Spots
 - 4 ea. 36109 Mesh Bags
- X66141 K-5 PE Starter Pack \$599.99 pk.
 X36026 Optional Storage Cart-not included in set. 299.99 **SALE 264.97 each**

*Full CHOKING HAZARD descriptions on page 355.



ZONE Elementary Foam Ball Class Pack

An assortment of 30 light weight foam balls for indoor or outdoor play.

- 1 set 29000 The ZONE Foam Footballs
- 1 set 10582 The ZONE 3.5" Bounce Free Balls
- 1 set 59004 The ZONE Foam Soccer Balls
- 1 set 10569 Foam Easy Grip Balls
- 1 set 10093 8" Foam Balls
- 1 ea. 36114 Mesh Bag

66546 \$229.99 **SALE \$169.97 ea.**



ZONE K-5 Playball Pack

30 soft, safe balls and 2 mesh bags!

Includes:

- 1 set 10136 The ZONE Grabby Ball set of 6
- 1 set 29000 The ZONE Foam Football set of 6
- 1 set 10066 The Zone Supr-Safe Soccer Balls

- 1 set 59004 The ZONE Foam Soccer Balls set of 6
- 2 each 36113 24" x 36" mesh bags
- 1 set 10220 The ZONE Softies PG8 set of 6

66715 \$218.99 **SALE \$169.97 set**

Bean Bag Mega Class Packs

You choose the bean bag you want!

Just the basics here: 48 bean bags- 24 of the 4" and 24 of the 5" and a black 24" x 36" Ultra-MESH™ Shoulder Bag for transport and storage. Your choice of bean bags: canvas, nylon, vinyl or fleece.



- 66101 Canvas Mega Pack - 48 bean bags & bag \$53.99 **SALE \$44.97 pk.**
- 66102 Nylon Mega Pack - 48 bean bags & bag 58.99 **SALE 41.97 pk.**
- 66104 Fleece Mega Pack - 48 bean bags & bag 53.99 **SALE 44.97 pk.**
- 66103 Vinyl Mega Pack - 48 bean bags & bag 61.99 **SALE 46.97 pk.**



Micro-Mesh Scrimmage Vests

Soft comfortable fabric with open hemmed bottom for an excellent fit.

Made from 100% micro mesh with reinforced seams and openings. Available in Youth (2nd-4th Grade) and Adult (5th Grade and up). Includes mesh bag.

- 66563 SET OF 6 Adult \$23.94 **SALE \$16.97 set**
- 22123 SET OF 6 Youth 23.94 **SALE 16.97 set**



Description	Neon	Neon	Red	Blue	Purple	Neon	Each	SALE
Youth	22026	22027	22018	22019	22121	22122	\$3.99	\$2.87
Adult	22028	22029	22030	22031	22003	22002	3.99	2.87
	Neon	Neon	Red	Blue	Purple	Neon	Pack	SALE
Youth 24 Pk	66190		66333			22130	\$95.76	67.97
Adult 24 Pk	66191		66334			66534	119.76	67.97
	Neon	Neon	Red	Blue	Purple	Neon	Pack	SALE
Youth 36 Pk	66440		66441			22131	\$143.64	100.97
Adult 36 Pk	66442		66443			66535	179.64	100.97
	Neon	Neon	Red	Blue	Purple	Neon	Pack	SALE
Youth 72 Pk	66444		66445			22132	\$287.28	199.97
Adult 72 Pk	66446		66447			66536	287.28	199.97



Micro Mesh Numbered Scrimmage Vests
Numbered 1 thru 12.
100% nylon micro mesh with silkscreened numbers on front and back.

Size	Red	Blue	Price
Youth	22032	22033	\$46.99
Adult	22034	22035	46.99



ZONE Straps & Flags

Create a multitude of cooperative games! Straps are 2" wide with tabbed ends for easy removal, hook and loop design allows for multiple belts to be connected and multiple flags on each belt. Flags measure 15" L x 1.5" W and are made from nylon webbing with hook tabs for easy attachment to straps. Medium straps measure up to 44" and large up to 56".

BELT SIZE	RED	ORANGE	YELLOW	GREEN	BLUE	PURPLE	PRICE
MEDIUM	32194	32195	32196	32197	32198	32199	\$3.99 ea.
LARGE	32253	32254	32255	32256	32257	32258	4.99 ea.
FLAGS	32206	32207	32208	32215	32210	32211	0.99 ea.



ZONE 12 Belt Class Packs

Packs include 12 belts; 6 of each color, 36 flags; 18 of each color, and mesh bag.

BELT SIZE	YELLOW	BLUE	RED	GREEN	ORANGE	PURPLE	PRICE
MEDIUM	32260		32261		32262		\$79.99 pk.
LARGE	32263		32264		32265		89.99 pk.



ZONE 36 Belt Class Packs

Each pack includes 36 belts, 108 flags, and mesh storage bag. Includes 6 belts and 18 flags of each color.

32266	Medium 36 Belt Class Pack	\$239.99 pk.
32267	Large 36 Belt Class Pack	269.99 pk.



Triple Threat Flag Football Belts

One piece construction-no flags to lose, everything stays together! Three heavy duty vinyl coated polyester flags are sewn permanently onto the strong web belt. Easy off polyethylene clip releases when flags are pulled. Available individually in 4 sizes and colors or 24 player packs.

Belt Size	Red	Yellow	Blue	Green	Price
20"-32"	32160	32164	32141	32145	\$3.97 ea.
26"-38"	32161	32165	32142	32146	
30"-44"	32162	32166	32143	32147	
36"-52"	32163	32167	32144	32148	

Middle School 24 Player Pack

- 12 ea. of 20"-32" Flag Belts- 6 each red & yellow
 - 12 ea. of 26"-38" Flag Belts- 6 each red & yellow
 - 1 ea. 36113 White Mesh Storage Bag
- 66340 \$109.99 **SALE \$99.97 pk.**

High School 24 Player Pack

- 12 ea. of 26"-38" Flag Belts- 6 each red & yellow
 - 12 ea. of 30"-44" Flag Belts- 6 each red & yellow
 - 1 ea. 36113 White Mesh Storage Bag
- 66341 \$109.99 **SALE \$99.97 pk.**



Flag-A-Tag

The flag that "Pops" on release!

The Flag-A-Tag has a unique concept where the flag is attached to a rubber socket and is inserted into another rubber plug worn on the belt. While in play the flag firmly stays on the belt, but when pulled off the belt a loud "pop" alerts everyone play should be stopped. Approved by the United States Flag and Touch Association and the International Women's and Men's Flags Football Association. Sold as complete units by the dozen. Each unit includes the belt, buckle, keeper, 2 flags and 2 sockets.

32322 Storage Ring-plastic ring holds 12- 18 belts \$5.99 ea.

Belt Size	Red	Gold	Green	Blue	Price	Sale
42"	32302	32303	32316	32317	\$74.99 dz.	\$64.97 dz.
52"	32300	32301	32308	32310	74.99 dz.	64.97 dz.

Flag-A-Tag 24 Player Kit

Designed to outfit two teams of twelve players. Includes 24 belts with flags and two storage rings.

- Red/Gold-32320 Green/Blue-32321
- 42" Belt \$148.99 **SALE \$131.97 pk.**
- Red/Gold-32318 Green/Blue-32319
- 52" Belt 148.99 **SALE 131.97 pk.**





ZONE Bowling Sets

One of the most affordable sets on the market.

Sand weighted 15" plastic pins have a slightly thinner wall than our traditional pins yet still weigh about 10 ounces. Your choice of 3 different weights with our PVC rubberized 3 hole smooth rolling ball.

- 15911 3 lb. Ball & 10 Pins \$94.90 **SALE \$72.97 set**
- 15912 4 lb. Ball & 10 Pins 104.90 **SALE 78.97 set**
- 15913 5 lb. Ball & 10 Pins 110.90 **SALE 83.97 set**
- 15078 Set Up Sheet Only (not included in sets) 7.99 ea.

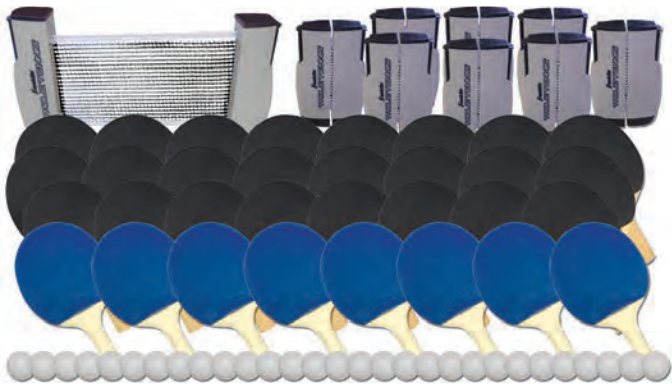

Table Tennis To Go Class Pack

32 player pack that is compact for the gym, rec room or class room! Nets easily attach to any rectangular table and adjust up to 75" in width! Includes 8 Table Tennis To Go Nets, 32 rubber face paddles, 144 recreational table tennis balls and a 24" x 36" mesh bag for storage or transport.

- 66407 \$255.50 **SALE \$214.99 pk.**



12 Player Putting Pack

Create challenging putting stations!

Packs include:

12 Safe-T Putters, 12 Colored Putting Balls, 12 Putt-O-Cups™ and a 36" L x 16" W x 16" H all purpose, heavy duty polyester equipment bag.

- 66117 Pack w/ 29" Putters \$349.99 pk.
- 66118 Pack w/ 33" Putters 349.99 pk.

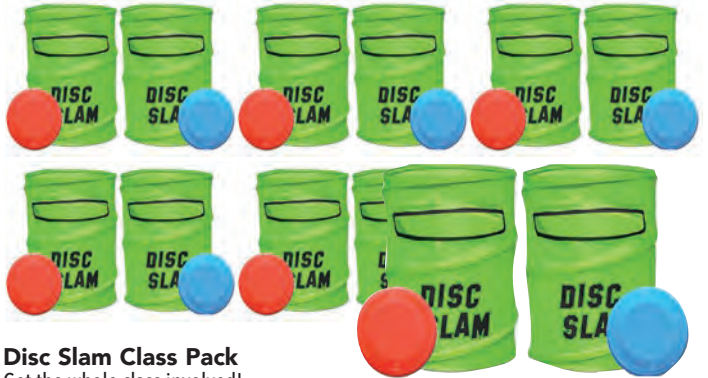

Disc Slam Class Pack

Get the whole class involved!

Class Pack includes 12- 8.5" discs, 12 collapsible targets and storage bags.

- 66548 Class Pack- 24 players \$164.99 set



Kan Jam® Packs

Keeps everyone moving!

School Set includes 10 goals, 5 official 11" discs and instructions. Class Pack includes 20 goals, 10 official 11" discs and instructions.

- 16172 School Set- 20 players \$169.99 set
- 66575 Class Pack- 40 players 339.98 pk.



Innova® Polecat All Purpose Golf Discs

One of our most popular Middle School golf disc.

A perfect way to introduce your class to Disc-Golf.

Colors may vary

- 11033 110 grams; 20.5 cm diameter \$6.99 ea.
- 11078 Class Pack of 24 with storage bag 167.76 **SALE 151.97 set**



POWER Disc

An 18 disc pack!

Includes:

- 1 set 11019 Set of 6 9" dia. discs
- 1 set 11025 Set of 6 9.5" dia. discs

- 1 set 11026 Set of 6 11" dia. discs
- 1 ea. 36114 24" x 36" white mesh bag

- 66466 \$53.00 **SALE \$39.97 pk.**



TriGoal Class Toss Pack

Featuring low bounce, low roll balls and soft cubes for tossing!

Includes 24 balls and 24 cubes. Break classes into 3 teams with each team using two colors to score points, such as red/orange, green/yellow and blue/purple. Or break into 6 color groups and assign different colors to each face of the TriGoal. Bounce Free Balls are made from low bounce foam and the 3" cubes are stuffed with super soft padding. Both are easy to throw and catch.

- 66512 TriGoal Class Toss Pack- includes 1 TriGoal, 24 balls & 24 cubes \$213.99 pk.
- 10582 Bounce Free Balls- set of 6..... 18.99 set
- 26013 Cannon Cube Bean Bags..... 29.99 dz.



Blindfold Activity Kit

24 blindfolds and 60 plastic gym pins.

Reinforce teamwork, communication and trust in your students. Sighted partners guide the blindfolded through a maze you create with the pins. Increase the challenge by adding obstacles, timing the event and adding scooters! Includes activity sheet.

- 66749 \$189.99 SALE \$129.97 kit



Early Elementary Game Pack
Perfect for the younger crowd!

- 1 ea. 15396 Trouble
- 1 ea. 15327 Uno
- 1 ea. 15326 Chutes & Ladders
- 1 ea. 15325 Sorry
- 1 ea. 15323 Candy Land

- 66357 \$61.99 pk.

⚠ CHOKING HAZARD (1) - SMALL PARTS. Not for under 3 yrs.*



Classic Game Pack

Assortment of classic board games.

- 1 ea. 15322 Battleship
- 1 ea. 15325 Sorry
- 1 ea. 15396 Trouble
- 1 ea. 15328 Connect Four
- 1 ea. 15321 Monopoly
- 1 ea. 15330 Checkers
- 1 ea. 15339 Chess

- 66722 \$99.99 pk.

⚠ CHOKING HAZARD (1) - SMALL PARTS. Not for under 3 yrs.*



Team Building Pack

Our most popular basic pack!

- Includes:
- 1 set 15406 Blindfold Color Set
 - 1 set 15804 Catch & Balance Set
 - 1 set 15864 Human Hoops
 - 1 set 15201 Partner Straps
 - 1 set 15474 Marble Run

- 66720 \$209.99 pk.

⚠ CHOKING HAZARD (5) - CONTAINS A MARBLE. Not for under 3 yrs.*



Speed Stacks® Skillastics® Deluxe Set

For up to 30 students!

Perfect for larger classes. Comes with everything you receive in the regular package plus Speed Stacks® stacking cups. Includes: 30 sets of Speed Stacks® with storage bag; 1, 5'x 7' big mat; 6 - 20" x 27" mini mats; 6 colored dice & beanbag markers; 26 - 5" x 7" laminated task cards; instructions, mat storage bag. ⚠ CHOKING HAZARD (1) - SMALL PARTS. Not for under 3 yrs.*

- 17277 \$849.00 set



Sport Packs

Everything to get a sport stacking program started!

Sport Packs are available in two sizes- a 15 or 30 pack. Choose either pack with 15 or 30 sets of Speed Stacks® in a variety of colors, a StackMat® with competition timer, a set of Super Stacks®, 5 day lesson plans, On the Move Activity Guide and soft carry bag.

- 15713 Sport Pack- 15 sets..... \$399.99 pk.
- 15714 Sport Pack- 30 sets..... 499.99 pk.

* Full CHOKING HAZARD descriptions on page 355.



ZONE 32 Soft Bocce Ball 4 Team Pack

For up to 32 players!

Includes 8 green, 8 red, 8 yellow and 8 blue, 2 jacks and two yellow storage buckets.

66316 \$382.99 **SALE \$199.97 pk.**



ZONE No Peek Volleyball Pack

A great twist to volleyball!

Block the view of opponents with the ripstop nylon 30'L x 6'H net and use these soft, oversized lightweight volleyballs for an exciting game. No Peek Net and Ball Pack includes: No-Peek net, Oversized Light Training Volleyball, The Zone Soft VB, and 20" Zebra Beach Ball. Complete System includes: (2) Zone POWRBase & Tall Post kits, No-Peek net, Oversized Light Training Volleyball, The Zone Soft VB, and 20" Zebra Beach Ball

66467 No Peek Net and Ball Pack \$109.99 **SALE \$98.97 pk.**

66819 Complete No Peek Volleyball Pack System 349.99 pk.



Bean Bag Toss Class Pack

Get the whole class involved!

Pack includes two different toss game boards, 12 buckets, a tic-tac-toe mat and a 48 nylon bean bag mega pack with storage bag.

66590 \$202.99 **SALE \$189.97 pk.**



Plastic Bat & Ball Starter Pack

Lightweight balls and bottle barrel bats.

Includes bases, cones, a pitching rubber, bats and balls in 2 sizes. Includes mesh carry bag.

Contents:

- 1 set 43253 Throw Down Bases w/ Pitching Rubber
- 2 sets 10520 9" Colored Whiffle Ball Sets
- 2 sets 10530 12" Colored Whiffle Ball Sets

- 2 ea. 21017 9" Plastic Cone
- 1 ea. 24003 30" Plastic Bat
- 1 ea. 24050 Jumbo Plastic Bat
- 1 ea. 36114 White Mesh Bag 24 x 36

66430 \$45.99 pk.

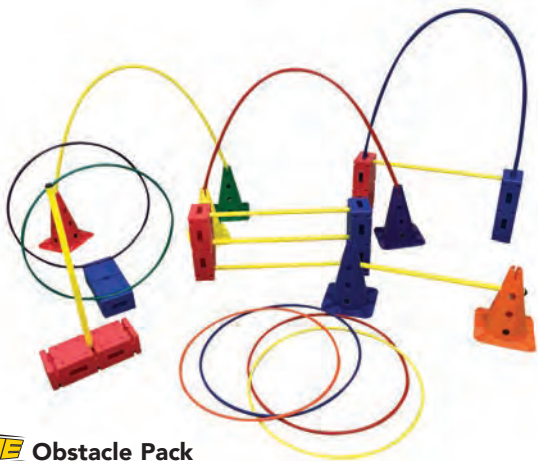

ZONE Obstacle Pack

Create multiple obstacles to climb through, over, under or around!

This pack includes 6 plastic 28" poles to use as hurdles or agility sticks, 6 Skinny No-Kink 24" hoops for use as targets or crawl zones, 3 multi-use arches for crawl unders, 6 plastic 14.25"L x 5.87"W x 3.75"H bricks with three openings for poles and 6 slotted 12" TheZone Cones w/Holes™ with multiple openings for pole placements.

13159 \$120.93 **SALE \$114.97 set**



Team Tossor Class Pack

Race to score points!

Simply divide the class into 6 color groups, have relay tosses or add locomotor skills, exercises or an obstacle course into the tossing fun! Set includes 48 canvas 4" bean bags in 6 colors and 6 targets with adjustable 16" steel coated frames.

66527 \$226.90 **SALE \$179.97 set**



NEW

ZONE Cones & Noodle Kit

As many uses and configurations as you can imagine. Create hurdles, obstacles and even arches. The flexible caterpillar connectors and bendable foam noodles makes this one of the most versatile packages available. Includes: (12) Zone Slotted Cones 12", (12) ea. of 10" and 6" Noodle Connectors, and (10) Foam Noodles 58"L x 2.75"D. X66797 \$119.99 kit



3C's HotSpot™ Class Pack

Calisthenics, cardio and core!
No equipment needed! 36 spots & activity guides.

Contents:
• 1 set 21118 Calisthenics HotSpots • 1 set 21171 Cardio HotSpots • 1 set 21138 Core HotSpots
21208 \$134.90 SALE \$124.97 pk.



Elementary Movement Pack

For high energy or calming classes.

Includes:
• 1 set 21172 Hoops HotSpots • 1 set 21139 Jump Rope HotSpots • 1 set 21135 Yoga HotSpots
66737 134.90 SALE \$124.97 pk.



Gill® Middle School VALUEPACK™

The official middle school track pack.
Pack includes: 2 rubber and 2 Essential™ 1.0 kilo discus, 2 cast iron 4 kilo shot puts and 2 shot/discus carriers.
X42158 \$257.90 SALE \$234.97 pk.



Basic Assessment Pack II

Create a 6 person testing station!

Includes:
• 2 ea. 25981 Push-Up Mat
• 2 ea. 25529 Flex-Tester
• 1 set 25183 Curl UP Assessment Mats
66553 \$469.99 SALE \$399.97 pk.

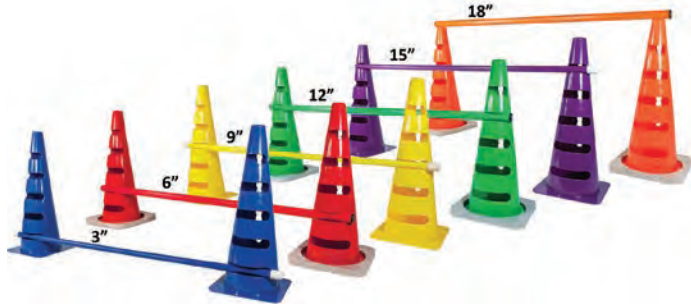

NEW

SlotCones™ & Poles Class Pack

Innovative slot design allows any size hoop or crossbar to be locked into the cone.
Pack includes:
• (2) Set of 6 21217 SlotCones
• (1) Set of 6 21234 Colored Crossbars 35.5" L
66837 \$129.99 pk.



ZONE Cone Set

Slotted on top; connecting holes in body!
A multi-purpose cone that allows you to connect plastic poles to make hurdles or display instruction sheets. 12" plastic cone with 12 holes. Set includes 6 cones in 6 colors and 3 yellow 28" plastic connecting poles.
21215 TheZone Cone Kit- 6 cones & 3 poles \$39.90 SALE 35.97 kit



Circuit Training & PE Stations Class Packs

Enough equipment for a class of 32!

Pack includes:

- 1 set 12074 9' Licorice Speed Ropes
- 4 ea. 53124 Light Exercise Tubing
- 1 ea. 13123 Agility Ladder 4 Pack
- 6 ea. 42002 6.5" Training Hurdles
- 4 ea. 10239 TheZone Soccer Ball
- 800046 Circuit Training & PE Stations CD-ROM
- 2 sets 21048 9" Cones
- 1 set 26077 4" Nylon Bean Bags
- 1 set 11019 9" dia. Flying Discs
- 8 ea. Dumbbells
- 2 ea. Rubber Medicine Balls

Elementary/Middle School Pack

Includes the above with 8- X52650 2 lb. Dumbbells and 2- 25116 4.4 lb. Rubber Medicine Balls.

66130 \$279.99 pk.

High School Pack

Includes the above with 8- X52651 3lb. Dumbbells and 2- 25117 6.6 lb. Rubber Medicine Balls.

66131 294.99 pk.



SPORTS HEALTH Deluxe .25" Yoga Mat

Longer and thicker for ultimate comfort!

Mat is 74"L x 24"W and a full .25" thick with a textured, non-slip surface. Made of highly durable closed cell vinyl foam with embedded fabric mesh, the mat will perform at a high level for many years. Lead and latex free.

- 52039** Deluxe Yoga Mat \$21.99 **SALE \$17.97 ea.**
- 66178** Basic 12 Pack: 12 Deluxe Mats & 2 Bags **299.99 SALE 249.97 pk.**
- 66179** Advanced 12 Pack: 12 Deluxe Mats, 12 blocks, & 2 Bags **399.99 SALE 329.97 pk.**



Pro-Tec Foam Roller Class Packs

Ideal for promoting recovery, flexibility, and stretching.

The 6 pack includes (3) 6" x 35" high density, full body, rollers and (3) 6" x 36" extra firm, heavy support, rollers. The 12 pack includes (6) 6" x 35" high density, full body, rollers and (6) 6" x 36" extra firm, heavy support, rollers.

- 66838** 6 Pack **\$179.99 pk.**
- 66839** 12 Pack **359.99 pk.**



BOSU® Pro Balance Trainer

BOSU® Pro Balance Trainer challenges the entire body with integrated, multi-joint movement that requires muscle groups to work together. Use the BOSU® Pro Balance Trainer dome or platform side down, combine it with other equipment, or use it as a stand-alone product to make any exercise fun, challenging, and effective. Inflates up to 9" high with a 26" diameter. Maximum weight capacity 350 lbs. 1 year limited warranty.

- 52276** Bosu® Pro Balance Trainer **\$159.95 ea.**
- 52277** Pro Quad Pack- 4 Pro Trainers only **599.99 pk.**
- X52244** Pro 16 Pack- 16 Pro Trainers only **2,019.99 pk.**
- X51022** Pro 6 Pack with Cardio Fusion DVD & Cart **999.99 pk.**



Premium Stability Ball Class Packs

9 balls and 6 poster pack!

Includes 9 balls and 2 posters featuring stretch, back and abs exercises!

- 66507** 55cm/22" Black 9 Ball Pack with 2 Posters **\$209.99 pk.**
- 66508** 65cm/26" Lt. Blue 9 Ball Pack with 2 Posters **209.99 pk.**
- 66509** 75cm/30" Dk. Blue 9 Ball Pack with 2 Posters **209.99 pk.**
- X36185** Optional 9 Ball Cart- measures 62"L x 18.5"W x 67"H **159.99 ea.**



SPORTS HEALTH Station Pack

Everything needed to keep groups moving!

The book provides 6 week sport specific training programs or you can create your own. Items included are the most often used in the book.

Pack includes:

- 2 ea. 13123 SPH Colored Agility Ladder 4 Pack
 - 1 ea. 54202 Speed Chute
 - 1 ea. 52550 Speed Harness
 - 6 ea. 52517 6" Hurdles
 - 1 ea. 10126 3" Reaction Ball
 - 6 ea. 21048 9" Plastic Cones
 - 1 ea. 38090 Speed, Agility and Quickness Book & DVD
- 66499** **\$189.99 pk.**



SPORTS HEALTH Fitness Band Loops

One piece band is perfect for arms and legs. Their light-weight durability, and ease of use, make fitness loops ideal for sculpting glutes and legs, stretching, and rehabilitation. 12"L x 2"W.

66802 Light Blue - 12 Light Bands	\$33.99 pk.
66803 Yellow - 12 Medium Bands	37.99 pk.
66804 Red - 12 Heavy Bands	39.99 pk.
66805 Essential - 4 Light, 4 Medium & 4 Heavy Bands	38.99 pk.
66806 Total - 20 (4 ea.) X-Light, Light, Medium, Heavy, X-Heavy	59.99 pk.



SPORTS HEALTH Medicine Ball Combo Pack

Designed for vigorous workout routines! One piece sturdy rubber construction has a textured surface for enhanced grip. Shape and bounce are maintained via a rubber valve. Includes one each of: 4 lbs., 6 lbs., 8 lbs., 10 lbs., & 12 lbs.

29569 Set of 5..... \$159.85 **SALE 139.97 set**



SPORTS HEALTH Resistance Tubing Class Packs

Cost effective workout method for your whole class! Sturdy tubing with foam covered plastic handles and web strapping for comfort and excellent grip. A variety of resistance levels to meet the needs of your classes. 36-tube pack includes: 9L, 18M, 9H - 2 Tubing posters and 12 Tubing Hotspots. 50-tube pack includes: 12L, 26M, 12H - 2 Tubing posters and 12 Tubing Hotspots.

66160 36-Tube Pack	\$358.99	SALE \$299.97 pk.
66162 50-Tube Pack	466.99	SALE 385.97 pk.



PREMIUM NEOPRENE COATING

Neoprene Hex Dumbbells Class Pack

Thick neoprene coating with hexagon design so they won't roll! Rack has locking bar, swivel casters and holds up to 500 lbs. Made from powder coated steel and measures 37.5"L x 16"W x 42.25"H. Ships by Truck. Includes: 16-1 lb., 12-2 lb., 10-3 lb., 10-4 lb., 9-5 lb., 8-6 lb., 8-7 lb., 8-8 lb., 7-9 lb., 7-10 lb. dumbbells and rack. Total weight 456 lbs.

T52660 \$989.99 pk.



ZONE Elementary School Jump Rope Pack

Our most popular elementary rope! Includes: 36 ea. 12040 7' Plastic Segmented Ropes 12 ea. 12041 8' Plastic Segmented Ropes

12134..... \$130.80 **SALE \$119.97 pk.**

Vinyl Double Dutch Jump Rope Pack

Includes: 3 pr. 12011 12" Rope 6 pr. 12013 16' Rope 3 pr. 12014 30' Rope

12132 Assorted Colors..... \$69.99 pk.





Wilson® Evolution

Ultra-durable with exceptional feel!

Exclusive HQ microfiber composite leather cover for the best performance. Aqua-Grip™ laid-in-channels provide enhanced grip. Cushion core technology combines low-density sponge rubber and ultra-butyl rubber. Choose from 13 color/size combinations. Indoor use only.



SIZE	GREEN	NAVY	YELLOW	ROYAL	SCARLET	Natural	PRICE
OFFICIAL	39223	39225	39227	39229	39231	37309	\$64.95 ea.
INTERMEDIATE	39224	39226	39228	39230	39232	37310	



Wilson® NCAA Solution

Moisture absorbing composite leather with Aqua-Grip.

Wilson's premier composite basketball improves grip and feel while maintaining traditional appearance. Indoor use only.

Description	Item #	Each
Official	37311	\$74.95
Intermediate	37312	74.95



Spalding® Precision Advanced Eco-Grip™

Eco-Grip™ composite cover is backed with recycled material. Soft out of the box and deep channels for a superior grip. Responsive cushioned sponge shell. Butyl bladder for air retention. NFHS approved. For indoor use.

Description	Item #	Each
Official	39242	\$59.99
Intermediate	39243	59.99



Spalding® TF-1000 Legacy™

An upgrade to Spalding's best-selling game ball!

Exclusive microfiber composite leather cover provides advanced moisture control. Rotationally balanced butyl bladder maximizes air retention. Indoor use only.

Description	Item #	Each
Official	39233	\$64.99
Intermediate	39234	64.99



Spalding® TF-1000 Classic

Back by popular demand!

Exclusive ZK Microfiber composite leather cover with responsive core, heritage wide channel and skived cover provides a true bounce and feel.

Description	Item #	Each
Official	37102	\$64.99
Intermediate	37168	54.99



Spalding® Replica NEVERFLAT®

NitroFlate® Inflation Technology. Premium double-ply air bladder maximizes pressure retention. Special valve keeps dirt out and prevents valve leaks. Guaranteed to stay inflated for 1 year. Official NBA size and weight.

Description	Item #	Each
Official	37600	\$44.99
Intermediate	37601	44.99



Wilson Jet® Competition

The ultimate soft touch ball. Premium composite leather offers a unique gripability and feel. Cushion Core Technology, patented Composite Leather laid-in channels for maximum grip and control, and superior butyl bladder for air retention. Indoor use only.

Description	Item #	Each
Official	37255	\$33.99
Intermediate	37256	33.99



Rawlings® CROSSOVER

High end composite leather construction with an amazing ultra soft feel. Features an 8 panel design along with deep skived channels for maximum grip. Nylon wound for shape retention with a butyl bladder. For indoor and outdoor use.

Description	Item #	Each
Official	37259	\$29.99
Intermediate	37260	29.99



Rawlings® IESA
Official ball of the Illinois Elementary School Association.

Tacky microfiber composite cover with a butyl bladder. Indoor use only. 2 Year Warranty.

Description	Item #	Each
Official	37307	\$64.99
Intermediate	37308	64.99

PRACTICE COMPOSITE



Wilson® NCAA Limited
Pressure lock bladder helps lock in air!
High-performance composite cover for unrivaled grip and control.
100% composite cover and laid in channels. Cushion core carcass for maximum softness and grip.

Description	Item #	Each
Official	37588	\$34.99



NEW

Spalding® NEVERFLAT® Max
NitroFlate® Inflation Technology.
Performance composite cover.
Premium double-ply air bladder.
Special valve keeps dirt out and prevents valve leaks. Guaranteed to stay inflated for 1 year. Official NBA size and weight.

Description	Item #	Each
Official	37602	\$29.99
Intermediate	37603	29.99



Spalding® TF-500
Improved composite technology.
The new composite cover offers a softer feel and grip. Two-ply butyl bladder for excellent long lasting air-retention.

Description	Item #	Each	SALE
Official	37464	\$29.99	\$27.97
Intermediate	37465	29.99	27.97



Wilson® NCAA Replica
Premium composite cover.
High-performance ball with great durability. Cushion Core Technology produces an exceptional soft touch and feel. Wide channel.

Description	Item #	Each
Official	37139	\$26.99
Intermediate	37140	26.99



Spalding® NBA Zi/O Excel
Premier indoor/outdoor composite ball.
Premium Zi/O composite cover with foam backing under the full-ball pebbling for precise ball handling.
Official NBA size and weight.

Description	Item #	Each
Official	37462	\$25.99
Intermediate	37463	25.99



Mikasa® BWL110
Superior feel and control.
An all new redesigned all weather leather composite cover. An excellent choice for indoor or outdoor use. Wide channel.

Description	Item #	Each
Official	37263	\$24.99
Intermediate	37264	24.99



NEW

Spalding® NEVERFLAT® Hexagrip
SGT™ Soft Grip Technology cover.
Special formulated sponge rubber ball construction. Ultra-soft touch feel with exceptional grip. Deep skived wide channel. NitroFlate® Inflation Technology guaranteed to stay inflated for 1 year.

Description	Item #	Each
Official	37604	\$24.99
Intermediate	37605	24.99



Spalding® NBA Tack-Soft
Extra tacky cover for superior grip.
Exclusive premium PU composite cover. Butyl bladder. Designed for indoor and outdoor use.

Description	Item #	Each
Official	37364	\$23.99
Intermediate	37365	23.99



Wilson® NCAA Composite
Tackified composite leather cover.
Cushion Core Technology with ultra-durable butyl rubber bladder. Wide channel. Composite Leather Cover for indoor/outdoor play.

Description	Item #	Each	SALE
Official	37118	\$23.97	\$23.97
Intermediate	37119	23.97	23.97



Wilson® NCAA Street Shot
High performance rubber carcass provides excellent rebound & bounce.
High quality synthetic leather cover provides exceptional feel and grip for improved ball control.

Description	Item #	Each
Official	37314	\$19.99
Intermediate	37315	19.99
Junior	37316	19.99



Spalding® TF-250
Improved composite cover with an excellent feel.
Superior nylon winding for long lasting indoor/outdoor durability.
Two-ply butyl bladder. Wide channel.

Description	Item #	Each	SALE
Official	37159	\$21.99	\$19.97
Intermediate	37165	21.99	19.97



Spalding® NBA All Conference
Tough indoor/outdoor cover.
An excellent composite cover that will withstand the day to day use of indoor and outdoor play. Built with a no leak butyl bladder.

Description	Item #	Each
Official	37366	\$19.99
Intermediate	37367	19.99

RUBBER BASKETBALLS



ZONE POWERGRIP
Basketball

Unsurpassed grip allows for more control. Cellular Rubber cover gives this ball a superior grip and feel. High quality Japanese wound bladder for increased air retention. Perfect for beginners and skilled players alike.

Description	Item #	Each	SALE
Official	37589	\$14.99	\$11.97
Intermediate	37590	13.99	11.50
Junior	37591	12.99	10.97
Pee Wee	37592	11.99	10.50

**AVAILABLE
IN 4 SIZES!**



PALOS PX-200™
Rubber Basketballs

Quality basketballs at a great price! All rubber with a deep pebble grain for a tacky feel with a true bounce every time. An ideal camp ball or for programs that need a price point basketball.

Description	Item #	Each	SALE
Official	37500	\$8.49	\$6.97
Intermediate	37501	8.49	6.97
Junior	37502	8.49	6.97
Pee Wee	37325	8.49	6.97

**AVAILABLE
IN 4 SIZES!**



Wilson® NCAA MVP

Optimal rubber cover for consistent performance. Recessed channel. Rotationally wound with multi-ply nylon and polyester thread produces an extremely durable and reliable ball.

Description	Item #	Each	SALE
Official	37505	\$10.99	\$9.97
Intermediate	37506	10.99	9.97
Junior	37507	10.99	9.97



Spalding® NBA Street

High performance rubber for all kinds of outdoor surfaces! Deep channel design with a sure grip cover for superior ball handling. No-leak butyl bladder. Official size and weight of the NBA. Designed for indoor or outdoor play.

Description	Item #	Each	SALE
Official	37394	\$14.99	\$12.97
Intermediate	37395	14.99	12.97



Mikasa® Premium Cover

Designed for outdoor play! Rubber cover with a great pebble grain, wide channels, nylon winding and butyl bladder. Longer lasting than most outdoor basketballs!

Description	Item #	Each
Official	37370	\$9.50 ea.
Intermediate	37371	9.50 ea.
Junior	37372	9.50 ea.



Spalding® TF-150

A great price point ball! Skived channels for improved grip! Deep pebble grain, nylon and polyester windings and durable rubber cover.

Description	Item #	Each	SALE
Official	37300	\$10.99	\$9.97
Intermediate	37301	10.99	9.97
Junior	37302	10.99	9.97



ZONE Train-A-Ball Basketball

Shows proper hand placement for left and right hand shooters. Excellent teaching aid. Cellular rubber construction for superior grip and feel.

37313 Intermediate \$16.99 ea.



Spalding® Rookie Gear™

25% lighter, Junior size 5 balls! High performance rubber cover, great feel, wide channel. Smaller size and lighter weight allows young players more success to make learning fun!

37508 Multi-Color \$11.99 ea.
37509 Tan 11.99 ea.



ZONE POWERGRIP
Basketballs

Designed to hold up on the toughest playing surfaces! Unique tire tread grip pattern. High grade natural rubber cover offers superior grip and extreme durability. Nylon butyl bladder for maximum shape/air retention. Indoor/outdoor use.

50436 Official \$14.99 ea.
50437 Intermediate 13.99 ea.
50438 Junior 12.99 ea.



Tachikara® Basketballs

Playful and patriotic! Made from top grade rubber with yarn winding for lasting performance. RWVB, available in 3 sizes.

Description	Item #	Each
Official	37160	\$9.50 ea.
Intermediate	37161	9.25 ea.
Junior	37162	8.99 ea.

RUBBER BASKETBALLS



ZONE POWERGRIP Basketballs

Grip the difference!

Cellular Rubber cover gives this ball a superior grip and feel. High quality Japanese wound bladder for increased air retention. Sold in sets of six in three sizes.

- 50439 SET OF 6 Official \$73.99 **SALE \$64.97 set**
- 50440 SET OF 6 Intermediate 73.99 **SALE 64.97 set**
- 50441 SET OF 6 Junior 73.99 **SALE 64.97 set**



PALOS PX-200 Rubber Basketballs

Affordable nylon wound rubber basketballs!

New improved quality- constructed with top grade rubber, yarn winding and deep pebble grain surface for long lasting durability and excellent touch and feel. Sold individually or in sets of six. Mini sold in sets only.

- 37115 SET OF 6 Official \$49.99 set
- 37116 SET OF 6 Intermediate 47.99 set
- 37117 SET OF 6 Junior 47.99 set
- 37000 SET OF 6 Minis 49.99 **SALE 36.97 set**

SIZE	RED	ORANGE	YELLOW	GREEN	BLUE	PURPLE	PRICE
OFFICIAL	37212	37213	37214	37215	37216	37217	\$8.49 ea.
INTERMEDIATE	37218	37219	37220	37221	37222	37223	
JUNIOR	37224	37225	37226	37227	37228	37229	



Voit® The Grip Basketballs

Super tacky finish for increased ball control.

Featuring a two ply cushioned cover that provides superior grip and feel. Wide channels, nylon wound with butyl bladder. Sold in sets of six.

- 37477 SET OF 6 Official \$75.99 set
- 37478 SET OF 6 Intermediate 75.99 set
- 37479 SET OF 6 Junior 75.99 set



Tachikara® Rubber Basketballs

Make your slam dunks even more colorful with Tachikara®'s rubber basketballs.

Available in Official size 7 or Intermediate size 6. Sold in sets of six.

- 37458 SET OF 6 Official \$49.99 set
- 37169 SET OF 6 Intermediate 48.99 set



Voit® Lite 80 Basketballs

20% lighter than standard basketballs!

Durable rubber construction with deep pebble grain and channels. Use indoors or outside.

- 37449 SET OF 6 Intermediate \$72.99 set
- 37450 SET OF 6 Junior 72.99 set

Mini Rubber Basketballs

Ideal youth ball for beginners!

Perfect for kids just learning to play the game. Durable rubber cover with deep pebble grain for a good grip. These balls are built to last!

- 37324 RWB - Size 3 \$6.99 ea.
- 37336 Orange - Size 3 6.99 ea.



WHICH BASKETBALL IS RIGHT FOR YOU?

SIZE	SIZE	SIZE	SIZE	SIZE
7	6	5	4	3
HIGH SCHOOL 6 UP 29.5" OFFICIAL	JR HIGH 6 UP 28.5" INTERMEDIATE	ELEMENTARY 27.5" JUNIOR	EARLY ELEMENTARY 25.5" PEE WEE	PRE-K-NOVELTY 22" MINI

GLASS BACKBOARDS



Gared® Buzzer Beater Gymnasium Package
Meets NFHS and NCAA specifications.

- 42" x 72" tempered .5" glass backboard, 5" x 4" hole pattern
- Welded steel frame for corner or direct mount
- Multi-directional break away goal with heavy duty anti-whip net
- Bolt on, Pro Mold Cushion Edge Padding; specify padding color
- Perimeter LED Light System Kit
- Ships by Truck

37525 **FREE SHIPPING**\$2,002.50 pk.

**PERIMETER
LED
LIGHT KIT**



Bison® Unbreakable Glass Backboard
Meets NFHS and NCAA specifications.

- Tempered .5" glass backboard; 5" x 4" or 5" x 5" hole pattern
- Aluminum frame with steel support structure
- Short 42" x 72" Backboard only w/ 35.5" x 62" mounting pattern
- Tall 48" x 72" Backboard only w/42" x 62" mounting pattern
- Ships by Truck

T37460 Short Backboard only \$889.99 ea.
T37461 Tall Backboard only 899.99 ea.



Gared® Steel Framed Glass Backboard
Meets NFHS and NCAA specifications.

- Tempered .5" glass backboard
- Welded steel frame for corner or direct mount
- 42"x72"; 5x4 hole pattern
- Ships by Truck

37016 42"x72" Backboard only **FREE SHIPPING** 900.00 ea.



Jaypro 42" Unbreakable Glass Backboards

Reinforced steel frame reduces load on glass!

- Aluminum channel and 5." Thick tempered glass
- Direct mount or four corner mount
- 4" x 5" hole pattern
- Ships by Truck

T37547 48"x72" Backboard only \$882.99 ea.
T37548 42"x72" Backboard only 794.99 ea.



Gared® Steel Framed Glass Backboard
Meets NFHS and NCAA specifications.

- Tempered .5" glass backboard
- Welded steel frame for corner or direct mount
- 48"x72"; 5x5 hole pattern
- Ships by Truck

37017 48"x72" Backboard only **FREE SHIPPING** ... \$ 900.00 ea.



Gared Conversion Steel Framed Backboard
Meets NFHS, NCAA and NAIA specifications.

- 42" x 72" tempered glass backboard , 5" x 4" hole pattern
- Powder coated steel frame
- Ships by Truck

37545 Backboard only **FREE SHIPPING** ... \$799.99 ea.



Jaypro 42" Conversion Glass Backboard

Converts a fan shaped backboard to a rectangular one.

- 20" x 35" mounting dimensions
- Aluminum frame with .5" tempered glass
- 4" x 5" hole pattern, 42" x 72" Backboard
- Ships by Truck

37549 Backboard only **FREE SHIPPING** \$1,049.99 ea.

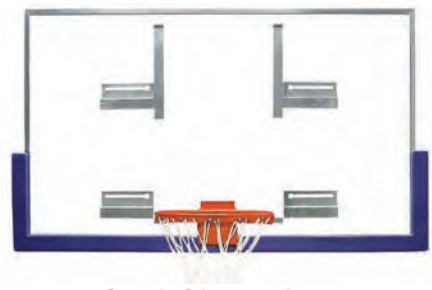

Bison Unbreakable XL Glass Conversion Backboard

Ideal for replacing fan shaped backboards!

- 42" x 72" tempered glass backboard
- 35" wide x 20" high mounting pattern
- 5" x 4" hole pattern
- Ships by Truck

T37392 Backboard only\$889.99 ea.

BACKBOARDS

Gared® Steel Fan-Shaped Backboards
For rugged playground use.

- 12 gauge steel
- White powder coat finish
- Measures 35" x 54"
- Mounting 20" x 35"
- Accepts 5" x 4 1/2" front mount goal
- Accepts 4" x 3 1/2" rear mount goal
- Goals sold separately
- Weighs 83 lbs.
- Three style choices: 1 front & 2 rear mount • Ships by Truck



24-HR SHIPPING

- T37187 Front Mount Backboard with Target only \$427.50 ea.
 T37190 Rear Mount Backboard with Target & Border 427.50 ea.
 T37038 Rear Mount Backboard- Plain..... 382.99 ea.

STEEL

Gared® Steel Rectangular Backboards
Vibration free with 12 gauge horizontal and 10 gauge vertical channels with 1.5" flange!

- 12 gauge powder coated steel
- Direct or 20" x 35" mounting
- Accepts 5" x 5" goals
- Orange border and target box • Ships by Truck



24-HR SHIPPING

- T37042 42" x 72" Backboard; weighs 131 lbs. \$719.99 ea.
 T37283 48" x 72" Backboard; weighs 147 lbs. 850.00 ea.

ALUMINUM

Gared® Aluminum Fan-Shaped Backboards
Rust proof molded cast aluminum!

- White powder coat finish
- Measures 36 1/2" x 54"
- Mounting 20" x 35"
- Accepts 5" x 5" or 5" x 4" front mount goals
- Goals sold separately
- Weighs 49 lbs.
- Available with or without target & border • Ships by Truck



24-HR SHIPPING

- T37204 Front Mount Aluminum Backboard with Target & Border..... \$419.99 ea.
 T37211 Front Mount Aluminum Backboard- Plain..... 389.99 ea.

ACRYLIC

Gared® Acrylic Rectangular Backboards
Versatile for indoor or outdoor use!

- 3/8" UV resistant acrylic
- 3/4" x 1 1/2" welded steel frame
- Struts for added board support
- Accepts 5" x 4.5" goals
- Goals sold separately
- White target box
- 60" mounting pattern: direct or 20" x 20"
- 72" mounting pattern: direct or 20" x 35" • Ships by Truck



24-HR SHIPPING

- T37232 42" x 60" Acrylic Backboard weighs 90 lbs. \$695.00 ea.
 T37278 42" x 72" Acrylic Backboard weighs 111 lbs. 795.00 ea.

Bison Fan Shaped Backboards
Choose polyethylene or heavy duty steel!

- 39" x 54" backboards with 5" x 5" hole patterns
 - 20" x 35" mounting on steel backboard
 - Direct pole mount on polyethylene
 - Goals sold separately • Ships by Truck
- T37550 Polyethylene..... \$1,065.99 ea.
 T37074 Heavy Duty Steel 689.99 ea.



Gared® Fiberglass Rectangular Backboard
For indoor or outdoor play!

- Strong molded fiberglass
 - Measures 42" x 72"
 - Mounting 20" x 35"
 - Accepts 5" x 4.5" front mount goals
 - Goals sold separately
 - Weighs 86 lbs. • Ships by Truck
- T37451..... \$795.00 ea.



Actual colors may vary.



Actual colors may vary.



Actual colors may vary.

LT PURPLE	GRAY	COLUMBIA	BLACK
KELLY	MAROON	ORANGE	FOREST
YELLOW	NAVY	SCARLET	ROYAL
GOLD	PURPLE	TX ORANGE	CARDINAL

PINK	COLUMBIA	ROYAL	NAVY
KELLY	FOREST	RED	MAROON
BURGUNDY	PURPLE	YELLOW	ORANGE
GOLD	BROWN	GRAY	BLACK

BLACK	KELLY	SCARLET	ROYAL
ORANGE	FOREST	COLUMBIA	MAROON
GOLD	GRAY	PURPLE	NAVY
VEGAS GOLD	CARDINAL	BROWN	BURNT ORANGE

Jaypro® Safe-Pro™ Padding

Bolt on edge padding to protect players!
 Bolts on easily to all 72" official glass backboards.
 Made with a self skinning urethane foam which includes 2 steel connectors to align pads and prevent sagging underneath the goal. Meets all NCAA, high school and FIBA specifications. Includes mounting hardware. **8 YEAR WARRANTY.**
 T37284 SPECIFY COLOR..... \$149.99 ea.

NEW COLOR
PINK

Gared® Pro Mold Cushion Edge

Bolts easily to all 72" official glass backboards.
 Special skin molding process protects the foam padding for durability. Meets all NCAA, high school and FIBA specifications. Mounting hardware included. **5 YEAR WARRANTY.**
 X37111 SPECIFY COLOR \$299.99 pr.
 X37062 SPECIFY COLOR 150.00 ea.

Bison® Duraskin® Padding

Slimmer cross section for reduced rebound!
 All Bison® glass backboards are predrilled for five-minute installation of padding with only a screwdriver. Meets all NCAA, FIBA and NHSF requirements. Mounting hardware included. **10 YEAR WARRANTY.**
 X37393 SPECIFY COLOR \$169.99 SALE \$152.97 ea.

NEW COLOR
PINK

FIXED GOALS



Gared® Rear Mount Double Rim
Double 5/8" rim for added strength.

Universal backplate fits most rear mount backboards. Baked powder coat finish, includes mounting hardware and nylon net.

X37034 \$129.99 ea.



Gared® 6600 Scholastic Rear Mount Goal
Built for aggressive play!

- Rear mount 5/8" x 18" single ring
- Stack spring mechanism
- Universal 9.5" x 7.5" back plate
- Includes nylon net; weighs 29 lbs.

X37044 \$224.99 ea.



Bison® Economy Goal
Affordable, well built, official size.

Made of steel with powder coat finish. Designed for lower cost backboards with multi-hole patterns. Multi-hole pattern fits most common inexpensive backboards, does not fit standard 5" x 5" or 5" x 4.5".

X37047 \$79.99 **SALE \$63.97ea.**



Gared® Rear Mount Goal

A universal back plate mounts to the back side of the backboard.

The goal is reinforced half way. Includes hardware and comes with a nylon net. Official size 18" x 5/8" round steel and has 12 "no-tie" net holders. Fits most rear mount type backboards.

X37040 \$84.99 ea.



Gared® Playground Double Goal

Affordable yet superior playground performance! Official size with 3/4" top ring and 1/2" bottom ring with dual bracing for extra side support. Includes net and mounting hardware.

X37383 \$98.99 ea.



Jaypro® Ultimate Playground Goal
Strongest outdoor fixed rim available!

Double, solid rim design with universal hole mounting system. No fail net lock system with a powder coated finish. Includes premium nylon net.

37148 \$175.99 ea.



Bison® Standard Front Mount Goals

Single front mount, complete with nylon net and hardware. Both styles are constructed with 5/8" round steel and 12 "no-tie" net holders. Universal hole pattern.

X37039 Basic Goal \$73.99 ea.

X37054 Supreme Goal (2X stronger) **SALE \$109.97 ea.**

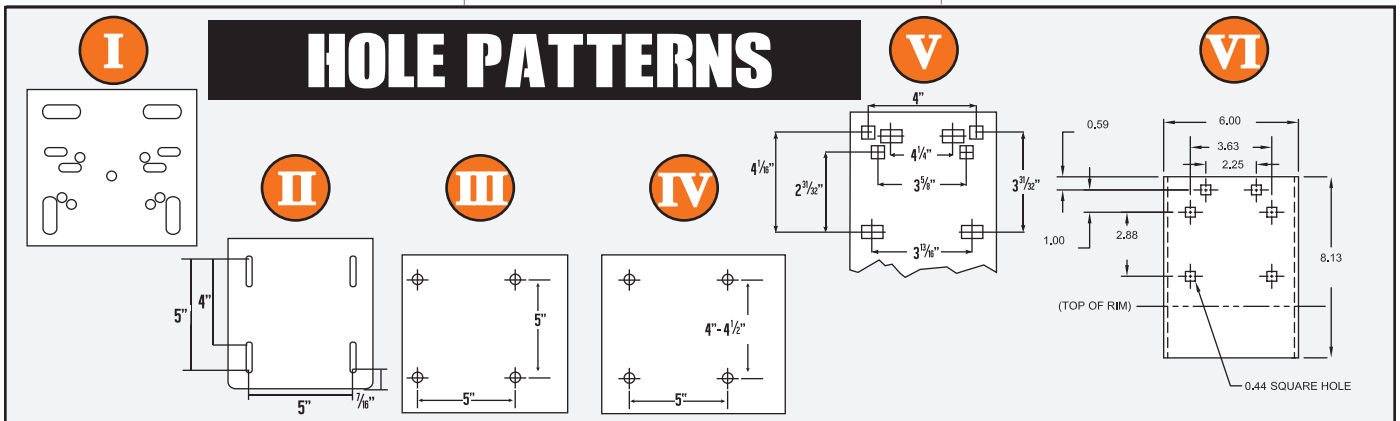

BREAKAWAY GOALS



Jaypro® Scholastic Breakaway Goal
Adjusts to withstand different levels of pressure!
Fits 5" x 4" hole patterns for all 42" glass backboards. Positive lock holds solid playing position. Made with powder coated steel and no tie ring. Meets NFHS and NCAA specifications.
37289 \$249.99 ea.



Bison Baseline 180° Goals
Pressure release mechanism is field adjustable!
Ring assembly floats on ball bearings for smooth flexibility from any direction. Baseline Collegiate goal is recommended for 42"x72" only. Universal Prep goal fits 48"x72" and 42"x72" backboards.
X37551 Collegiate goal- 4" x 5" hole pattern \$486.99 ea.
X37552 Universal Prep goal- hole pattern II 441.99 ea.



Bison® ProTech Breakaway Goal
Maintenance free design.
Unique hardened ball and socket positive-lock breakaway mechanism provides the best rebound consistency on the market. 3 year warranty. Universal backplate mounts to most backboards. 23 lbs.
X37189 \$219.99 **SALE \$195.97 ea.**



Gared® 2000+ Collegiate Goal
Most popular goal on the market!
• Positive lock mechanism • Universal backplate
• Meets NFHS and NCAA specs
• Continuous no tie ring
• Includes anti-whip net; weighs 26 lbs.
37006 \$224.99 ea.



Bison® Removable Practice Rim
Available in one or two height brackets.
Mounts directly to the wall-perfect for areas where permanent goals would interfere. Official size goal slides into its track for quick setup and removal. Available in single and adjustable bracket. Adjustable bracket can be mounted and rim can be placed at either of the two heights 12 inches apart. All brackets and matching rim sold separately.
X37047 Rim only w/ nylon net \$79.99 ea.
37045 Single bracket only 89.99 ea.
37046 Adjustable bracket only 124.99 ea.



Bison Elite Breakaway Goal
Fully welded .25" rim support.
• Safety padded cover plate
• AcuFlex adjustable tension release mechanism
• 4 Point lubrication system
• Includes 1/4" rim support, net & hardware
X37191 \$265.99 ea.



Spalding® Flex Goal
Designed with 600 lb. bend strength!
• Reflex mechanism • Meets NFHS specs
• Ram horns no ties for easy net install
• Recommended for indoor play only
• Includes nylon net; weighs 25 lbs.
X37144 \$164.99 ea.



Bison® BA32XL Hang Tough™ Goal
Simplified breakaway mechanism!
• Heavy-duty construction
• Long life for programs at all levels
• Meets NFHS standards
• Includes competition net and mounting hardware
X37536 \$199.99 **SALE \$174.97 ea.**

Basic Nylon Net
Excellent price-point general use nets.
• 4mm nylon netting
• With or w/o anti-whip loops
37431 Basic \$2.49 ea.
37433 Anti-whip 3.99 ea.



Professional Anti-Whip Net
For competition and game use.
• 6mm heavy nylon netting
• Retains shape longer
• Firm polyethylene anti-whip loops
37210 \$6.47 **SALE \$6.47 ea.**



Heavy Nylon Net
Superior recreational net.
• 6mm heavy nylon netting
• Extra-heavy feel
• Anti-whip loops
• Retains shape longer
37435 \$5.99 **SALE \$4.97 ea.**



Carron® Anti-Whip Nets
The net that started it all.
• Premium quality
• Flight-control anti-whip
• Sold in pairs only
37438 Awn-nylon 26.99 pr.
37439 AWC-cotton 36.99 pr.

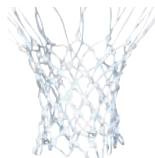

Polyethylene Net
Indoor/outdoor use.
• Polyethylene twine
• Heavy duty, won't rot
• No whip action
37445 \$4.99 ea.



Steel Net
For tough playground use.
• Nickel plated steel
• Will not rust
• Outdoor use
37436 \$7.99 **SALE \$6.67 ea.**



Anywhere Goal™
Take the game anywhere you go.
Portable goal can be hung or attached to anything using the integrated clip. Place the goal at any height. 18" regulation size. Use indoors or out.
37593 \$58.99 ea.

Web Outdoor Net
Safe alternative to steel nets.
• Nylon web strapping
• Will not rust, rot or decay
• Includes "S" hooks
37443 \$29.99 ea.



OUTDOOR GOAL SYSTEM



Gared® Heavy Duty Bent Post Systems

25 year warranty on pole.

- 3 goal choices: Lifetime Titan Goal, Titan Breakaway or Double Ring Super Goal
- Your choice natural or white powder coated aluminum backboards
- 4.5" O.D. galvanized steel gooseneck pole with 4' or 5' backboard extension
- Goals bolt directly to backboards
- All forces of "slam dunking" are absorbed by the heavy steel post, not the backboard
- All goals include nylon net
- Ships by Truck

System with Double Ring Super Goal

- T37348 Pole w/ 4' ft ext., White Backboard with Target, Super Goal & Net \$976.50 ea.
- T37349 Pole w/ 4' ft ext., Natural Aluminum Backboard, Super Goal & Net 909.00 ea.
- T37350 Pole w/ 5' ft ext., White Backboard with Target, Super Goal & Net 1,111.50 ea.
- T37351 Pole w/ 5' ft ext., Natural Aluminum Backboard, Super Goal & Net 1,044.00 ea.

System with Lifetime Double Ring Goal

- T37340 Pole w/ 4' ft ext., White Backboard with Target, Titan Goal & Net \$1,035.00 ea.
- T37341 Pole w/ 4' ft ext., Natural Aluminum Backboard, Titan Goal & Net 967.50 ea.
- T37342 Pole w/ 5' ft ext., White Backboard with Target, Titan Goal & Net 1,170.00 ea.
- T37343 Pole w/ 5' ft ext., Natural Aluminum Backboard, Titan Goal & Net 1,102.50 ea.

System with Breakaway Goal

- T37344 Pole w/ 4' ft ext., White Backboard with Target, Titan Breakaway Goal & Net \$1,080.00 ea.
- T37345 Pole w/ 4' ft ext., Natural Aluminum Backboard, Titan Breakaway Goal & Net 1,012.50 ea.
- T37346 Pole w/ 5' ft ext., White Backboard with Target, Titan Breakaway Goal & Net 1,215.00 ea.
- T37347 Pole w/ 5' ft ext., Natural Aluminum Backboard, Titan Breakaway Goal & Net 1,147.50 ea.



SCORING AIDS

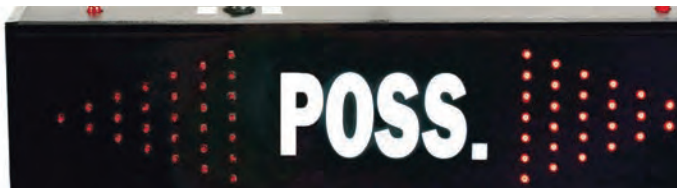

LED Basketball Possession Indicator

With bright, 10,000 hour LED lights!

Sturdy plastic case, easy to use toggle switch operation.

Includes 15' power cord. Measures 20"L x 5"H x 2"D; weighs 4 lbs.

37487 \$129.99 ea.



Plastic Indicator

Light weight and portable!

Bright yellow color for high visibility. Possession arrow screened on both sides. Measures 10" x 7"

37101 \$19.99 ea.



Portable Flip-A-Score

Built in handles to take anywhere!

This table top model scores up to 99 with large 6" numbers and period indicator. Folds flat for storage.

Measures 24"L x 12"H.

49013 \$49.99 ea.



Lace Up Post Pads

Fits on any post of 3"-5" diameter!

1.5" thick polyurethane foam with reinforced vinyl cover. Pad measures 14" wide x 84" tall with heavy laces and reinforced grommets to prevent tearing. Padding covers most of post. Posts over 4" diameter will have exposed grommet side.

RED	YELLOW	GREEN	BLUE	BLACK	WHITE	PRICE	SALE
X37242	X37243	X37244	X37245	X37246	X37247	\$119.99	\$109.97

BACKBOARD ADAPTERS



GREAT FOR DEVELOPING ELEMENTARY SHOOTING SKILLS

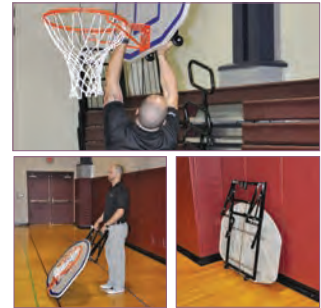
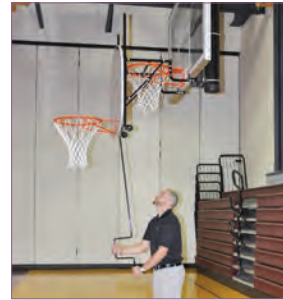

The New Generation Little Champ™

Safely attaches to any goal and backboard!

Designed to fit on any style rim and standard 42" backboard, with or without edge padding. Frame features adjustment hinge to ensure the board is always plumb. Hinged rim folds up and rear frame folds in for compact storage. Brings the goal 2' closer to the foul line. Installs in seconds by one person from the floor with no damage to the rim. Includes a 35" x 48" graphite fan shaped backboard, attachment frame and official size goal with nylon net. Not designed to be hung on or to withstand slam dunking.

- X37493 Little Champ™ 8.5 Backboard Adapter- stationary \$1,029.99 pr.
- X37494 Little Champ™ Easy Adjust Backboard Adapter- adjusts from 6'6" to 8'6"..... 1,519.99 pr.

Jaypro® Little Champ™ Classic Basketball Adapter
Convert an existing goal to 8'6" youth height.

Easily installs from floor by one person. Safely attaches to any goal and 42" backboard. Hand knobs secure unit to existing goal. Moves backboard 2' closer to free throw line. Includes a pair of fan-shaped backboards, attachment frames, official size goals, and nylon nets.

- 37171 \$719.99 pr.

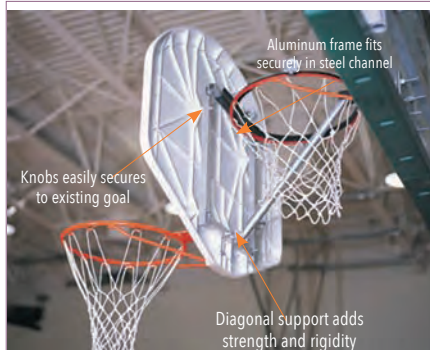

Bison Easy-Up™ Youth Goal
Convert your 10' goal to the height you need without tools!

Designed to fit any style goal. Tubular frame attaches to goal with cam operated lever with the rim 24" closer to the free throw line at 8' high. Backboard is 48" x 32" and made from a molded high impact ABS plastic with shooter box graphics. Single steel rim is official size. Folds down for storage. Entire unit weighs less than 40 lbs. Not suitable for dunking or hanging on the rim. Unit height adjust sizes: 6.5', 7', 7.5', 8', 8.5', and 9'. Designed for indoor use only- not for residential or outdoor play. Ships fully assembled via UPS oversized.

- 37196 6 in 1 Youth Mini Goal..... \$599.99 ea.



Bison® Removable Rim Basketball System
Curb unattended play- just remove the goal!

Removable Rim Bracket Kit simply mounts on backboards with 5" x 5" goal mounting pattern. Goal slides in and out for easy on or off. Basketball System includes an aluminum 35.5" x 54" unpainted backboard, single 5/8" steel rim with net, 3.5" O.D. steel pole with 3' backboard extension, removable bracket, telescoping pole and mounting hardware. Removable Rim Bracket Kit when purchased separately does not include goal. Purchase goals 37082 or 37039 separately.

- T37209 Basketball System \$1,199.99 ea.
- X37082 Double Rim w/Net 139.99 ea.
- X37199 Removable Rim Bracket Kit only. 169.99 ea.



Bison® Qwik-Change Shooting Stations
Wall mounted & height adjusting!

Your choice of a 36" x 48" molded graphite fan-shaped backboard or 32" x 48" rectangular acrylic backboard. Adjusts from 7.5' to 10' in 6" increments. Flex goal mounted directly to steel structure for superior backboard durability. Use indoors or outdoors, easily mounts to wall with two load spreading struts; 22" setback at 10'. Hardware NOT included. Ships oversized UPS.

- 37174 Graphite Shooting Station; weighs 85 lbs. \$719.99 ea.
- 37376 Acrylic Shooting Station; weighs 100 lbs. 949.99 ea.



Bison Zip Crank™ Adjustable Shooting Station
Easy to operate with removable hand crank!

Station features a .5" thick, 54" x 36" acrylic backboard with shooter box and framework, a competition design breakaway goal with direct mount and steel structure which mounts to the wall by means of three load spreading struts. Adjusts with a hand crank from 7.5' to 10' with a 30" setback at 10'. Use indoors or outside. Wall mounting anchors not included. Weighs 180 lbs.

- T37192..... \$1,399.99 ea.



PORTABLE SYSTEMS

Spalding® Fastbreak 940 Portable Backstop

For institutional or recreational use.

- Pro Image™ breakaway goal
- Heavy duty steel base and post
- 6' setback at 10' goal height
- 54" x 32" aluminum framed 3/8" acrylic backboard
- Includes multi-piece padding
- Adjusts from 7' to 10'
- All steel, welded construction
- Requires up to 450 lbs of additional ballast
- Casters for transport
- 117"L x 54"W x 49"H portable stored dimensions
- Weighs 477 lbs. • Ships by truck.

T37380 \$2,795.00 ea.



Spalding® 54" Portable Basketball System
Available in Acrylic or Glass backboard!

- Arena Slam® flex goal
- 54" steel framed acrylic or glass backboard
- Screw Jack™ infinite adjust system from 7.5' to 10'
- Three piece 3.5"-for acrylic, 4" for glass steel pole system
- 20 degree angle for safe play
- 40 gallon portable base fills with sand or water
- Provides up to 330 lbs. ballast
- Base cover acts as a rebounder during play
- Backboard padding included
- Front transport wheels • Ships by truck.

T37385 Acrylic Backboard; 203 lbs. (Shown) \$699.99 ea.

T37384 Glass Backboard; 208 lbs..... \$699.99 ea.



Spalding® The Beast™
Arena quality play anywhere you go!

- Pro Image® breakaway goal
- 60" x 36" tempered 1/4" glass backboard
- 1" x 1" steel frame with aluminum trim
- Massive, 2 piece, 5" square pole
- 4 strut pole & base mount for stability
- Infinite adjusting from 7.5'-10'
- Screw Jack Lift system for smooth adjusting
- 55 gallon ballast with dual water level gauges
- No tilt wheel design for easy transport
- Assembly required; weighs 355 lbs.
- Ships by truck

37295 FREE SHIPPING..... \$1,099.99 ea.



SLAM-IT RIM WITH DOUBLE SPRINGS

Lifetime Courtside Portable System
Easy set up for play!

- All weather net
- 48" x 30" 2.5mm thick Makrolon™ backboard
- Quick Adjust II mechanism adjusts backboard 8' to 10' in 4" increments
- 3 piece powder coated steel round pole
- 31 gallon base to fill with sand or water
- Front transport wheels, weighs 74 lbs. • Ships by truck.

T37553..... \$249.99 ea.



Lifetime® World Class XL System
An easy to move portable system!

- Slam-It™ flex goal
- 50" x 33" acrylic backboard
- 1.5" thick steel framed backboard
- Power Lift™ height adjustment
- Infinite adjustments from 7.5' to 10'
- Pneumatic mechanism for easy adjusting
- Front wheels for transport
- 3.5" O.D. steel pole
- 35 gallon base fills with sand or water
- Provides 292 lbs. ballast with water; 490 lbs. ballast with sand
- Base can bolt to concrete; weighs 116 lbs. • Ships by truck.

T37013 \$429.99 ea.



Bison Playtime™ Portable Basketball System

Complete basketball standard with portable access to roll in and out of the gym.

- Official size 5/8" solid steel goal
- 36" x 48" molded graphite backboard
- Adjusts 6.5' to 8' in 6" increments
- Includes structure padding
- Lower base trim protects the floor
- Steel tubular poles
- Not intended for aggressive play
- Weighs 330 lbs.
- Ships by truck

T37184..... \$999.99 ea.



Hercules® 52" Vertical Pole
High quality at a great price!

- Pro-Slam™ goal
- 52"x 32" x 3.5mm steel framed acrylic backboard
- Adjusts from 7.5' to 10' in 6" increments
- Three piece 3.5" pole system
- Vertical angle for safe play
- 37 gallon ballast (water)
- Backboard padding included
- Black vinyl pole pad with NBA graphics
- Front transport wheels; weighs 123 lbs. • Ships by truck.

T37170 \$429.99 ea.



Spalding® Fastbreak 930 Portable Backstop
Adjustable portable system!

- Arena Slam™ breakaway goal
- 48" x 32" aluminum framed 3/8" acrylic backboard
- Heavy duty steel base and post
- Includes multi-piece padding
- Adjusts from 7' to 10'
- All steel, welded construction
- Vinyl trimmed base to protect floors
- Requires up to 200 lbs of additional ballast
- Casters for transport
- 117"L x 48"W x 49"H portable stored dimensions
- Weighs 256 lbs.
- Ships by truck

T37379..... \$1,080.00 ea.



PORTABLE SYSTEMS



ZONE Junior Basketball Set

Easy to adjust hoop helps kids learn basketball skills and self-confidence! Excellent for use indoors or outside. Fill the base with water or sand. Heavy-duty screws for durable, easy, set up. Includes basketball, pump/needle, & premium net. Six height adjustments. From 37" to 57". Dimensions: 15.75"L x 22"W x 70"H. **⚠️ CHOKING HAZARD (1) - SMALL PARTS. Not for under 3 yrs.***
54284 \$55.99 ea.



Junior Basketball Rim

Folds for storage!
 Constructed with a metal frame that assembles quickly and easily. Measures 30" x 30" x 33.5"H. Can be used indoors or for outdoor play. Folds for storage.
X37521 \$119.99 ea.



Goal Ball

Use the Goal Ball system to improve hand-eye coordination! Safe, portable and practical, this extremely durable steel system can be used just about anywhere to enhance free throw skills or as an introduction to basketball. Nylon netting easily attaches with eye hooks. Available either in 4'H x 3'W or 6'H x 3'W.
X15150 4'H \$164.99 ea.
X15151 6'H 219.99 ea.



Spalding® Youth Basketball System

Ideal for use with a size 3 junior basketball!
 Includes a 14" diameter steel goal, 32" composite fan shaped backboard, three piece 2" diameter steel pole and molded base. Height adjusts from 4.5' to 6'. Fill base with water or sand for additional ballast. Designed for indoor/outdoor play.
X37279 \$129.99 ea.

Movin' Hoop™

Challenge players of all ages and skill levels! Adjust the support rope for quick height adjustment or pull the rope for a moving target. Vary heights according to skill and age level of players by simply wrapping the 28' long rope with a clip to any overhead support. Hoop is made from sturdy plastic with a 22" diameter and 28' support rope. Not designed for players to hang on or slam dunk! Activity Guide included.
X37397 \$99.99 ea.

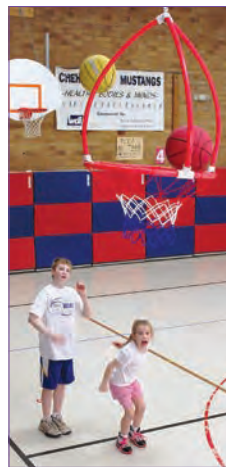

NEW

Circle Starter Hoop

The first starter hoop with no screws, nuts or bolts needed for assembly.
 Designed for institutional use. High-impact plastic 1" dia. post will not kink. Assembles easily with clips. Breaks down flat. Works best with foam, plastic and other lightweight balls. Dimensions: 18"D rim; 36"D base; 3.5' tall.
37594 \$71.99 ea.

Adjustable Multi-Ring Basketball Stand

Features main 18" diameter center goal with 3 adjustable 16" diameter side goals. Side goals swivel into hoop for storage. Frame is made from steel with powder coat finish and rubberized feet to protect floors. Storage bag converts into ball holder by attaching to frame during use. Main frame measures 31"L x 27"W x 54"H.
X37381 \$154.99 ea.



4 Ring Basketball Stand

Four different height settings!
 Main hoop is 18" in diameter, additional hoops are 16" in diameter. The 3 outer hoops turn in for easy storage. Rim heights: 53", 50", 46", and 42". Steel tubing frame. Storage bag fits into bottom of stand. Measures 36.5"L x 36.5"W x 54"H.
X37522 \$204.99 ea.



*Full **CHOKING HAZARD** descriptions on page 355.

TRAINING AIDS



SKLZ» Dribble Stick

Basketball dribbling and agility trainer. Improves hand positioning, stance and speed with the ball, adjustable arms enable a wide variety of drills for ball control, speed with the dribble, plyometrics and agility. Includes the base, 4 dribble arms and guide. 36" high.

37554 \$89.99 ea.

SKLZ» D-Man®

The portable hands up defender! Shoot over for proper shot trajectory, dribble around one or more D-Men for ball-handling skills and court awareness. Adjustable height of 5.5'-6.5' plus an additional 1.5' of arms and hands. Easy fold, pop up mesh and sturdy wire frame with base and ground stakes. Fill base with ballast of sand or water (not included).

X37399 \$62.99 ea.

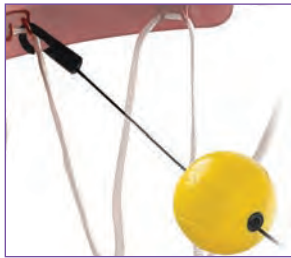

SKLZ» Shooting Target

Gives players a true visual target in the center of the rim! Bright yellow, 8" target ball. Flexible bungee cord with hooks attaches easily to the rim (no tools required). Does not alter ball flight. Includes target and usage guide.

39239 \$9.99 ea.



Spalding Universal Shot Trainer

It's like having up to three defenders wherever you practice! Three adjustable variations. Form position forces players to keep elbows tucked. Practice jumpshots with the extended arm position. Guard defender position works for cross-over and step-back drills. Designed for athletes from 4' to 7' in height.

39240 \$99.99 ea.



Neon Orange Spot Markers

Numbered 1-30. These bright spot markers measure 8.25" and feature a flexible slip resistant backing so they stay where you want them. Spots are made of vinyl and are numbered 1 through 30. Use for a variety of games and activities.

21200 \$68.99 **SALE \$57.97 set**



Basketball Spots

Ideal for shooting stations, drill placement or scatter on the court for designing plays. For indoor or outdoor play. 12" diameter.

21210 \$60.99 set



The Shooter

Prevents over action of the arm and increases wrist and forearm strength for better shooting! Isolates shooting muscles to ensure better follow through.

37404 \$19.99 ea.



Pure Shot Shooting Aid

Eliminate bad shooting habits before they start! Forces players to control the ball with the shooting hand only.

37405 R Hand \$19.99 ea.
37406 L Hand 19.99 ea.



Shooting Glove

Keeps the ball out of the palm and on the fingertips for proper shooting form.

Youth
37407 R Hand 37408 L Hand .. \$21.99 ea.
Adult
37409 R Hand 37410 L Hand ... 21.99 ea.



Dribble Aid

Fits closer to the face for a more comfortable fit and blocks downward vision. Teaches kids to look up while dribbling the basketball. Can be safely worn in team drills and scrimmages.

37100 \$4.99 ea.



NEW

Mikasa® V200W
Official FIVB indoor game ball. Perfectly balanced 18-panel aerodynamic design that improves ball movement and gives players greater control. Features a double-dimpled microfiber surface, anti-sweat surface, butyl bladder and nylon winding.
33623 \$63.99 ea.



NFHS®



33612 White 33613 Blue/White/Silver 33614 Scarlet/White/Navy 33615 Scarlet/White/Black

Tachikara 5W-PRIME®
More control for a better game. 18 panel laminated construction with T-TEC Micro-Leather for an enhanced tactile playing experience and increased ball control.
Specify Color \$42.99 ea.

Spalding Volleyball VB3
V-seam construction makes the VB3 durable to last season after season. Made with a tournament grade composite leather cover that allows for better ball feel when passing, setting and spiking. A floating butyl bladder provides maximum air retention.
33622 \$41.99 ea.



COMPOSITE VOLLEYBALLS



33591 White 33595 Red/White/Blue 33592 Black/White 33594 Red/White 33593 Blue/White

Mikasa® VIP300
High performance composite. Superb tack and feel with cotton wrapped construction providing extra softness.
Specify color \$46.99 **SALE \$39.97 ea.**

LEATHER VOLLEYBALLS



33100 White 33355 Blue/White/Grey 33356 Scarlet/White/Navy 33357 Scarlet/White/Blk

Tachikara® SV5W Gold
Now available in colors! Premium leather cover with woven cotton under panels for a soft touch, dual butyl bladder for superior control and increased air retention.
Specify Color \$51.99 **SALE \$46.97 ea.**

NFHS®



33101 White 33455 Blue/White/Silver 33171 Scarlet/White/Royal 33297 Scarlet/White/Black

Tachikara SV-5WM
Perfect value for practice or game. 18 panel laminated full grain leather ball with Loose Bladder Construction® with butyl bladder. Great feel, great price!
Specify Color \$38.99 ea.

NFHS®



33001 White 33457 Black/White 33459 Red/White/Blue 33460 Blue/White/Silver

Wilson® K1™ **NEW**
Official volleyball for Illinois High School. Constructed with Japanese full grain leather, latex power lining for speed after contact, butyl bladder for increased air retention and durable V-Tec seams.
Specify Color \$64.99 ea.



Tachikara® Weighted Volleyball
Top grade Sensi-Tec® composite leather. Weighted 16 oz. training ball in single unit construction.
33020 \$37.99 ea.



Rawlings® VB1001 IESA
Official Illinois ball for IESA. Soft, microfiber composite cover with a high grade butyl bladder.
33082 \$56.99 ea.

COMPOSITE VOLLEYBALLS



33007 White
 33159 Scarlet/Wht/Silver
 33133 Gold/Wht/Cardinal
 33160 Orange/Wht/Navy
 33088 Gold/Wht/Black
 33157 Dk. Green/Wht/Silver
 33015 Cardinal/White
 33017 Orange/White
 33014 Yellow/White
 33120 Dk. Green/Wht/V. Gold
 33156 Pwdr. Blue/Wht/Black
 33258 Pwdr. Blue/Wht/Navy
 33018 Navy/Wht
 33158 Navy/Wht/Silver
 33262 Black/Wht/Silver
 33104 Pink/White
 33013 Royal/White
 33000 Dk. Green/White
 33086 Scarlet/Wht/Royal
 33087 Scarlet/Wht/Black
 33136 Gold/Wht/Royal
 33019 Black/White
 33253 Scarlet/Wht/Navy
 33256 Cardinal/Wht/Silver
 33132 Orange/Wht/Black
 33134 Yellow/Wht/Dk. Green
 33254 Teal/Wht/Black
 33154 Royal/Wht/Silver
 33260 Royal/Wht/Black
 33016 Purple/White
 33135 Gold/Wht/Purple
 33263 Pink/Wht/Black
 33012 Scarlet/White

Tachikara® SV5WS Volleyballs
 New breed of composite material "Sensi-Tec™", super soft play.
 A new revolution in Tactile Technology provides the closest thing to leather on the market (18 panels).



Specify Color \$34.99 **SALE \$29.97 ea.**

ALL COLORS APPROVED BY THE NFHS



33379 Green/White
 33380 Purple/White
 33381 Black/White
 33382 Scarlet/White/Blue
 33383 Scarlet/White/Black
 33384 Scarlet/Gold/Wht
 33385 Green/Gold/Wht
 33386 Col. Blue/Navy/White
 33387 Royal/Gold/Wht
 33388 Royal/Black/White
 33228 White
 33374 Scarlet/Wht
 33375 Gold/White
 33231 Royal/White
 33377 Navy/White

Mikasa® VQ2000 Plus
 NFHS approved!

Super soft, micro-cell composite cover with fabric layer inners for Accu-Balance true shape retention. Airlock butyl bladder. Official size and weight.

Specify Color **\$37.99 ea. \$34.97 ea.**

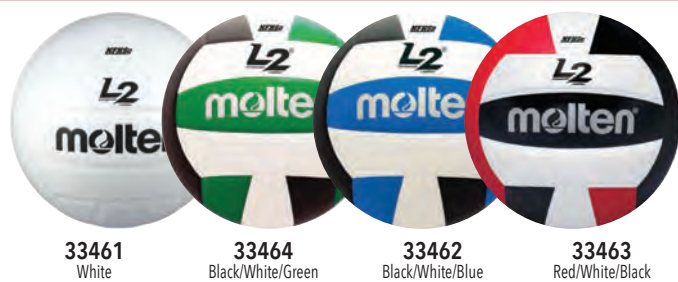

33461 White
 33464 Black/White/Green
 33462 Black/White/Blue
 33463 Red/White/Black

Molten® L2
 NFHS approved!

This ball has a great feel with a soft, micro-fiber composite cover and cotton wrapped Uni-bladder.

33461 White **\$28.99 ea.**
 Specify Color **36.99 ea.**



33008 White
 33491 Royal
 33490 Scarlet
 33493 Royal/Scarlet
 33494 Black/Red

Tachikara® SV-18S
 Improved woven fiber V100™ composite material over select cotton reinforcement.

Excellent for school and recreational play; single unit construction.

Specify Color **\$19.99 ea.**

Wilson® Impact
 Composite leather cover.

A perfect practice or P.E. ball. Wound carcass construction with v-tec seams. Official size.

33150 **\$21.99 ea.**



INDOOR/OUTDOOR VOLLEYBALLS



33541
White



33542
Blue

Wilson® SoftPlay™ Volleyball

A great elementary PE or camp ball.

Super soft hand-sewn synthetic sponge backed cover with a 100% butyl bladder.

Specify Color \$11.99 ea.



33437
Black/White

33110
Royal/White

33112
Green/White

33111
Gold/White

33107
Orange/White

33109
Red/White

Champro® Camp Volleyball

A great P.E. or camp volleyball.

Super soft hand-sewn synthetic cover with a 100% butyl bladder.

Specify Color \$13.99 ea.

33449 Set of 6 79.99 set

NEW

Mikasa® VS123W-SL Training Ball
Ideal for the beginning volleyball players (6-12 years).

This volleyball is made of low impact EVA-foam and has the same 18-part panel construction as the official match ball by Mikasa. 7 ounces. Size 5.

33624 \$18.99 ea.



ZONE Feather Soft Volleyball

Recommended for ages 2-8.

Bump, serve and spike without the "bite" of a typical volleyball. New EVA foam hybrid material is soft to the touch. Perfect introductory ball, yet plays and reacts like a traditional volleyball. 10 panel design, grades 2-8, official size, 6.4 oz.

33620 \$21.99 **SALE \$17.97 ea.**



33174
Blue/Red

33409
Yellow/Red

33596
Yellow/Green

Mikasa® Squish Volley

Pillow cover, no sting, soft volleyball!

These exceptional volleyballs have been developed to lessen the "sting" when the ball is hit. Measures 8", waterproof and perfect for recreational play.

Specify Color \$14.99 ea.



33600
White

33601
Red/White/Blue

33603
Royal/White/Yellow

33602
Black/White/Scarlet

Tachikara® VX2

A Soft-Tec® foam backed panel volleyball.

Ideal for camps, P.E. and recreational play. Man-made material with foam backing for softness, machine stitching and a butyl bladder.

Specify Color \$13.99 ea.



33435
White



33436
Red/White/Blue

Mikasa® VSL215

Designed for indoor/outdoor play.

An extremely durable synthetic cover that can withstand many surfaces. Cloth wrapped, reinforced butyl bladder.

Specify Color \$16.99 ea.



33599
Pink Zebra



33597
Checks

Tachikara® SoftTec® Volleyballs

For camps, special events or just for fun!

With a surprisingly great feel, these balls have a man made cover with a foam backing for virtually no sting during play. Machine stitching on the seams for indoor or outdoor play.

Specify Color \$13.99 ea.

INDOOR/OUTDOOR VOLLEYBALL

Mikasa VXS13B-1 Grand Slam Beach Volleyball
Perfect ball for a pick-up game!
Recreational play model has soft stitched synthetic cover. Outdoor play, official size and weight.
39238.....\$14.99



NEW
Wilson® NCAA Beach Championship Game Volleyball
Premium microfiber cover.
Ball has 18 panels, butyl bladder and is hand sewn.
33630 \$64.95 ea.

ST-200 Camo Ball
For grass, sand or indoors!
Awesome graphics for easy eye tracking, machine sewn PVC Performance Touch cover for great feel. Butyl bladder.
33113..... \$14.99 **SALE \$11.97 ea.**



NEW
Mikasa® King of the Beach®
Official ball of the King of the Beach® Tour.
Constructed with a hand stitched premium all-weather composite leather cover for durability, excellent top spin and flight. Strong butyl bladder for superior air retention. Size 5.
33629..... \$35.99 ea.



NEW
Mikasa® VXL30
Excellent for beach play.
This ball features a unique 10-panel construction, soft stitched cover and butyl airlock bladder. Size 5.
33625.....\$15.99 ea.



NEW
Mikasa® VLS30
Official FIVB outdoor ball.
Designed with a soft composite cover to provide tolerance against sweat, water and heat. Double cloth backing for shape retention. Curved 10-panel design for easy tracking. TwinSTLock™ stitching system prevents open panels. Size 5.
33626.....\$53.99 ea.

RUBBER VOLLEYBALLS

PALOS PX-200™ Rubber Volleyball
Super soft feel at a great price!
Tough waterproof 18 panel cover with 100% butyl bladder and nylon winding for strength and a soft feel.
33091.....\$7.99 ea.



Dura-GRIP Rubber Volleyballs
Another great addition for your colored sets.
Rubber nylon wound 18 panel colored volleyballs. Official size and weight.
33105 **SET OF 6**\$39.99 set



Tachikara® Super Soft Rubber Volleyball
Great for elementary play.
White, 12-panel, top-grade super soft rubber volleyball with nylon winding for durability.
33006.....\$11.99 ea.



Voit® V5RWB Rubber Volleyball
Soft ball ideal for indoors or outside!
Molded rubber construction with a nylon wound bladder. 12 panel design.
33444.....\$11.99 ea.

TEACHING VOLLEYBALLS



Tachikara® Volley-Lite™
 Extra lightweight ball for players 12 and under. This ball is designed to assist youngsters in achieving skills without having the fear of a heavy ball. Recommended by elementary P.E. educators. Sensi-Tec® composite cover and butyl bladder. Sold individually or in a set of 6.
 33035 White 33010 R-W-B 33024 Scarlet/White/Black \$28.99 ea.
 33178 SET OF 6 \$189.99 **SALE 166.97 set**

Gripper Sport Volleyball
 Plays in all conditions!
 Heavy duty composite pebbled vinyl with foam matrix grip covering. Butyl bladder. 8.5" diameter.
 33605 \$19.99 ea.



Voit Budget Volley Trainer
 Has a sponge like vinyl cover!
 Great feel, oversized ball that's 18% larger and 12% lighter than a regulation volleyball.
 33617 Blue/Yellow \$18.99 ea.



Molten® First Touch
 Ideal for players aged 10 and under.
 Soft and safe weighing only 5 ounces!
 Constructed with a soft cloth and foam cover with a springy rubber bladder.
 33037 \$15.99 ea.



Mikasa® Volley Starter
 Soft synthetic stitched leather.
 100% butyl rubber bladder. Lightweight, sting free for helping beginners with hand eye coordination and reducing fear of playing. Both are 25% lighter than a regulation volleyball.
 33022 Oversized \$19.99 ea.
 33023 Regulation 18.99 ea.



ZONE Soft Touch No Sting Volleyball
 Ideal recreation and practice ball!
 A combination of soft neoprene and honeycomb textured panels creates superior grip and takes the sting out of hits. Incredibly lightweight and durable bladder. Two-tone, 18 panel cover. 8.5"D. Set of 6.
 33621 SET OF 6 \$69.99 **SALE \$59.97 set**



Lightweight Trainer Set
 Traditional size but 20% lighter!
 Hand sewn vinyl panels with lightweight bladder. Set of 6.
 33411 SET OF 6 \$67.99 ea.



Training Balls
 Excellent for skill training grades 6 and under!
 Constructed of hand sewn vinyl covered nylon. 20% lighter than a traditional volleyball.
 10227 Jr. size \$12.79 ea.
 10228 Regulation size 12.79 ea.
 10229 Oversized 13.99 ea.

TEACHING VOLLEYBALLS



Voitt® Featherlite Volleyballs

Oversized and lightweight for youth play!

Big, 16" diameter ball with a soft, nylon cover and a heavy duty PVC bladder. Inflates like any regular athletic ball with no bladders to tie up and replace!

- 10562 SET OF 6 \$96.99 set
- 10564 Assorted Colors 17.99 ea.



THE ZONE

Oversized Neoprene Volleyball Set

No sting ball is 25% larger than an official volleyball.

Made with a durable neoprene cover with foam backing for a soft feel, butyl bladder to retain air and shape and strong stitched seams.

- 33468 SET OF 6 \$74.99 set



Rhino SoftEEZE™ Volleyballs

Soft and easy grip ball is excellent for beginners!

A junior size ball that is ideal for elementary players.

Made with durable RhinoSkin tacky cover and a rubber/butyl bladder.

- 10374 SET OF 6 \$84.99 set



Volley-Trainer™ Ball Set

Great feel, soft and safe for indoor play.

High density, low bounce, 8" uncoated foam balls!

Very difficult to pick apart yet has a good playing feel.

- 33318 SET OF 6 \$59.99 set



Hav-A-Ball™ Volleyball

Unique soft cover for great feel!

A great oversized ball for young players. This soft and safe 22" diameter has a durable cloth-like cover with a butyl bladder.

- 17171 \$19.99 ea.



THE ZONE

Heavy Weight Colored Beach Balls

Designed for long lasting use!

Built with thicker vinyl panels and stronger seams than standard beach balls.

- 10522 18" Set of 6 \$48.99 SALE \$39.97 set
- 10523 24" Set of 6 69.99 SALE 59.97 set

35" OVERSIZED!

Jumbo Inflatable Volleyball

Oversized game, set and match fun!

Inflated to 35" in diameter, this vinyl beach ball type ball will score high points with your classes.

- 33443 \$15.99 ea.



Gripper Multi-Trainer Ball

Ideal ball for many net games!

Combines a soft, tacky feel, grippy textured cover and an oversized 10" diameter to create an outstanding ball.

- 10995 \$21.99 ea.



Zebra Beach Ball

Excellent elementary volleyball.

Made with a durable PVC cover, ball will outlast traditional beach balls. This brightly striped ball inflates to 12" dia. and weighs 8 oz.

- 10077 \$5.99 ea.



THE ZONE

Soft-VB Volleyball

Soft foam like cover for safe play!

This 8" diameter ball is designed for no-sting play. Perfect introductory ball for young players.

- 10238 \$12.99 ea.



Tachikara®

Soft-V™ Oversized Volleyball

Learn to play with no fear of impact!

Great for all types of industrial and recreational play! "No Sting" fabric cover is foam backed nylon. Butyl bladder. 9.75" diameter.

- 10251 \$19.99 ea.

TRAINING AIDS

Target Challenger

Adjustable for multiple uses!

Pole height and target ring adjust to accommodate any kind of passing, setting or shooting drill. Steel construction with 22 lb. counter weight for stability. Pole height reaches up to 12' high and target ring measures 30" in diameter.

33217 \$299.99 ea.



Spike Challenger

The ultimate spike training device!

Pre-positioned ball for a perfect set every time! Includes a ready to attach ball with cord system. Constructed of metal with coated finish, this unit is weighted for stability and includes 2 transport wheels. Adjusts for hitters of all sizes and skill levels.

X33210 \$629.99 ea.



NEW

Spike Pal Volleyball Trainer

Improve your hitting technique without ever chasing a ball.

Work on arm swing, ball contact, and footwork without a partner. Includes ball pouch, 15.5" elastic cord, and carabiner that attaches to basketball hoops or other anchor points. Ball not included.

33627 \$21.99 ea.



The Spot™ Target Trainer

Excellent player positioning tool!

Great for teaching rotation, offensive or defensive plays or for spiking, serving and setting accuracy. Each spot has a textured, non-slip fabric top with rubber bottom. 17" diameter. Set of six spots.

33448 \$49.99 set

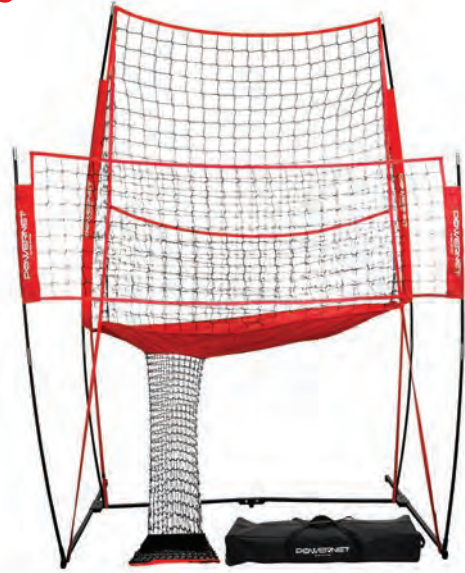

PowerNet Volleyball Practice Station

Set up indoors or outdoors!

Designed for front net training. Get valuable reps setting, passing, spiking and serving. Use on its own or behind a regulation net to catch balls during practice. Includes carry bag. Measures 8'W x 11'H; weighs 42 lbs.

33619 \$399.99 ea.



Pass Rite

Improve passing skills!

An easy to use training tool that uses a durable elastic band to prevent excessive upward arm movement. Attaches to the passer's wrists and ankles by lightweight Velcro® cuffs. The small wrist cuffs are designed to minimize ball contact interference and the elastic band adjusts to accommodate any passer's height.

33227 \$23.99 ea.



Asics® Slider™ Kneepads

Comfortable, yet protective.

A wider coverage, low profile pad. Shock absorbing foam pad has flexible design for ease of play. One size fits all, available in black or white.

33098 Black \$13.99 pr.

33099 White 13.99 pr.

TRAINING AIDS

9 Square In The Air

Fast paced game that keeps everyone moving! Object of the game is to remain the longest active player in the squares. The center square serves the ball by striking it into any other square. If the ball goes out of bounds the last player to touch it is out, leaves their square and the remaining players move up a square. A new player enters the square for the last position. The fast paced game means nobody stays out for long. Constructed from PVC pipe. Set includes all of the PVC pipes, legs, metal connectors, assembly tools, game ball, carry bags and activity guide.



X16392 Measures 18' x 18', adjusts from 5' to 7' heights..... \$899.99 set
18257 5 Ball Replacement Pack 32.99 pk.



5 BALL REPLACEMENT PACK



ZONE No-Peek Volleyball System

Take the classic game to a whole new level. The solid "no-peek" panel replaces the traditional volleyball net adding excitement and challenge. Ideal for use with jumbo or oversized balls. Made from rip stop nylon with a stitched top vinyl net tape and rope cables on the top and bottom. Measures 30"L x 6'H. Choose from a solo panel or package options



33544 No-Peek Panel (only)..... \$79.99 ea.
66467 Panel & Ball Pack - No-Peek net, Oversized Light Training Volleyball, The Zone Soft VB, 20" Zebra Beach Ball..... 109.99 SALE 98.97 pk.
66819 Complete No-Peek System - (2) Zone POWRBase & Tall Post kits, No-Peek net, Oversized Light Training Volleyball, The Zone Soft VB, 20" Zebra Beach Ball 349.99 pk.

Tachikara DS-1 Premium Ball Cart

With exclusive DropStep™ foot activated open and close mechanism and locking system. Black anodized, square tubed aluminum frame and high denier canvas with reinforced seams. Non-marking 5" oversized wheels and exterior coaches pocket. Cart will hold up to 24 inflated balls. Measures 24"W x 25"D x 44"H. X33456 \$156.99 ea.



Tachikara® Ball Cart

Tachikara's portable storage ball cart. Designed with extra height, a sturdy square aluminum frame, larger caster wheels and includes a durable nylon carrying bag with a shoulder strap. Completely collapsible. Expanded size 25"W x 25"D x 40"H. Specify Color \$119.99 SALE \$109.97 ea.



Tachikara® Quick Reach Volleyball Cart

For coaches who run fast paced drills! Hammock style nylon basket is perfect to reach in and quickly grabbing a ball. Made with a sturdy galvanized steel frame and tough nylon cover this cart will hold up to 24 inflated balls. Includes nylon carry bag with shoulder strap. Expanded size 48"L x 22"W x 12"D x 40"H. Specify Color \$119.99 SALE \$109.97 ea.

HOLDS 6 BALLS

Tachikara® Volleyball Bag

Stores and transports volleyballs and accessories. Durable nylon with new mesh side pockets and haul handle with Velcro®. Measures 24"L x 15.75"W x 8"H. 33188 Black \$18.99 ea.



OUTDOOR VOLLEYBALL SYSTEMS



NEW

CROSSNET

Four square meets volleyball.

Crossnet is the first official four-way volleyball game. It combines traditional four square and volleyball rules in a competitive game. Games play to 11 points, with the winner by 2 points. Quickly adjust from four-way competition to traditional volleyball short court play or three-way skills training. The four-way net is adjustable for children's, women's, and men's outdoor volleyball heights. Set up in grass or sand. Each Crossnet includes a convenient travel backpack, a volleyball and a ball inflator pump.

33628 **\$144.99 ea.**



ALL PACKS INCLUDE

6 FREE
SOFT SHOT VOLLEYBALLS!

Outdoor Volleyball Systems

Your choice of steel or rope cable nets!

Constructed of 2 3/4" diameter galvanized steel standards with ground sleeves that insert 2' down into ground sleeves or can be permanently installed in concrete. Poles have eye bolts for net attachment and are pre-drilled for volleyball, badminton and tennis. Systems include a 32' x 3' net-your choice of rope or steel cable top. Ships by truck.

Rope Cable Net Systems

Use net cleats to tie on rope top cable.

T33451 Steel Uprights/ Rope Top Cable Net/ PVC Ground Sleeves/ No Cap **\$349.99 set**

T33452 Steel Uprights/ Rope Top Cable Net/ Steel Ground Sleeves/ With Cap ... **439.99 set**

Steel Cable Net Systems

T33244 Steel Uprights/ Steel Top Cable Net/ PVC Ground Sleeves/ No Cap **\$364.99 set**

T33453 Steel Uprights/ Steel Top Cable Net/ Steel Ground Sleeves/ With Cap.... **489.99 set**



Spectrum 2000

Designed for a simple set-up and quality play.

One of the best recreational volleyball systems available. Two piece 1.75" aluminum telescopic poles for multiple height settings and durability. You will be in awe at how easy the set-up is and how unique the .25" guyline with upper swivel lock system will make for an extremely taut net. Complete with poly-pro net, stakes, pre-measured boundary lines with winder, and carrying bag. If you're looking for a top of the line beach volleyball set-up, this is it.

33061 **\$239.99 SALE \$229.97 set**

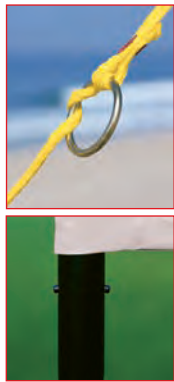

Spiker Flex™ Volleyball System

Easy glide system for unlimited height adjustments!

Ideal for all age and skill levels. Quick and easy set up with ringed guylines for maximum tension. Includes a pair of 1.5" diameter 3 piece steel poles, 3' x 32' Momentum Net with slip on straps, set of 4-8" ground stakes, boundary marker set, soft touch ball with pump and heavy duty bag.

X33065 **\$119.99 set**



Tournament 4000T Outdoor Volleyball System

Comes with ground sleeves for semi-permanent installation!

Lightweight, 4" O.D. telescopic aluminum posts with markings for men's and co-ed play. Includes hardware, 32' steel cable net with side dowels, level ratchet for net tensioning and pre-measured 1" webbing boundary lines for grass and/or sand play. Ground sleeves are PVC with protective caps and measure 4" x 54" long. Includes storage bag. Unit weighs 85 lbs.

X33243 **\$699.99 set**

Rope Boundary Line

Measures 30' x 60' and can be used for grass or sand.

The .25" rope comes with a durable plastic storage reel, corner ties, center court marking and plastic corner stakes.

33223 **\$27.99 set**



NETS

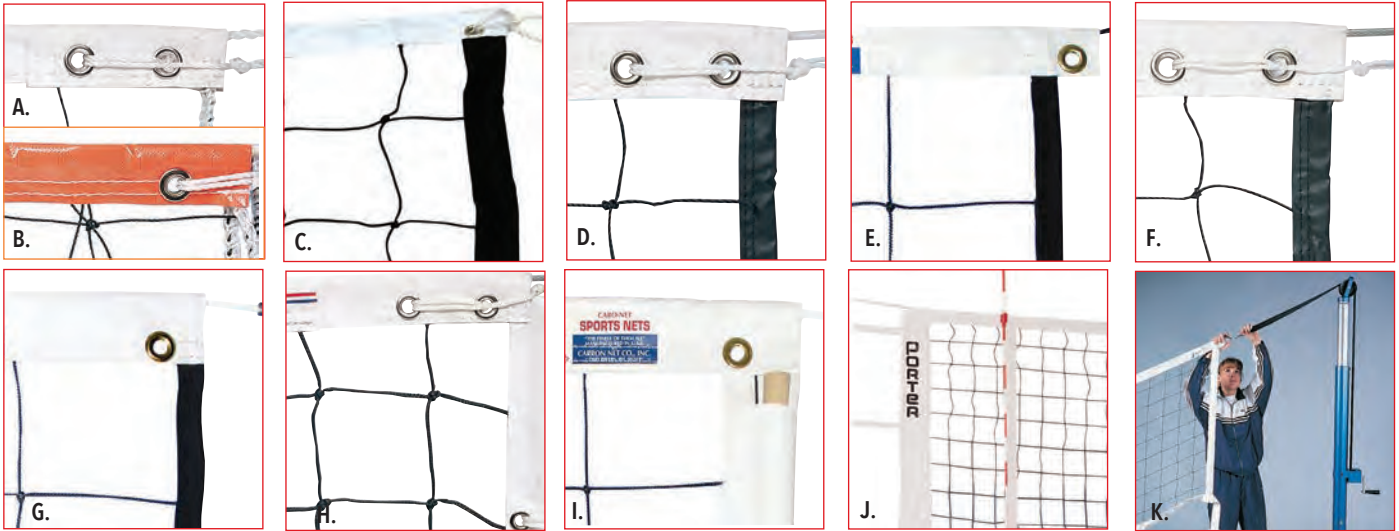

Item #	Description	Size	Finish	Netting	Top/Bottom	Price
33045	A. Junior Size Net	27' x 3'	2" white taped headband, rope sides	2.2 mm knotless nylon	Rope top	\$21.99 ea.
33049	B. Orange Net-P.E.	32' x 3'	1 1/4" vinyl headband, rope sides	2.0 mm nylon	Rope top	23.99 ea.
33064	C. Economy P.E.	32' x 3'	2" white taped headband, 1" taped sides	2.5 mm knotless nylon	Rope top	34.99 ea.
33063	D. Duro Net-P.E.	32' x 3'	2.5" white taped headband taped sides and bottom	2.6 mm knotless nylon	Rope top	36.97 ea.
33050	E. Carron Net Premium P.E.	32' x 3'	2.5" white taped headband and bottom	2.0 mm knotless nylon	38' Rope top	77.99 ea.
33042	F. Maxi Net-P.E.	32' x 3'	2.5" white taped headband Taped sides and bottom	2.6 mm knotless nylon	Coated steel top Rope bottom	49.99 ea.
33051	G. Carron Net Hercules*	32' x 3'	2.5" white taped headband. Taped sides and bottom. Made in the U.S.A	2.0 mm weather treated flexabar nylon	Coated steel top 38'	102.99 ea.
33041	H. Power Net Competition	32' x 3'4" (1m)	2.5" white taped headband top/bottom Side pockets and wooden dowels	2.6 mm knotless nylon	38' Vinyl coated steel top and bottom	92.99 ea.
33060	I. Carron Net Competition	32' x 3'	2.5" white taped headband top/bottom Side pockets and wooden dowels	2.0 mm weather treated flexabar nylon	Vinyl coated steel 41' top and 38' bottom	169.99 ea.
33611	J. Porter* Universal Comp. Net	32' x 39' x 47'	2.5" white taped headband top/bottom Side pockets and fiberglass dowels	#24 nylon cord	47' Vinyl Kevlar fiber top rope	269.99 ea.
30046	Spalding* Competition	32' x 1 meter	2.5" white taped headband top/bottom Side pockets and wooden dowels	2.3 mm nylon	34' coated steel cable top and 40' rope bottom	529.99 ea.
33038	K. Jaypro* Flex Net Competition	32' x 1 meter	2" white headband on top, sides and bottom.	2.3 mm nylon	42' Top Cable	499.99 ea.



Premium Volleyball Antenna
High quality antenna made of durable glass fiber. Features clamps that attach to both the top and bottom of net. Fits both 36" and 1 meter nets. Set includes 2 antenna and case. X33216..... \$89.99 set

Collapsible Volleyball Antenna
White pocket is 2" wide with Velcro® straps that secure system to the net. Fiberglass red/white antenna slips easily into the pocket for correct positioning on the net. Fits both 36" and 1 meter nets. Includes 2 collapsible antenna with carry bag. X33404..... \$74.99 pr.

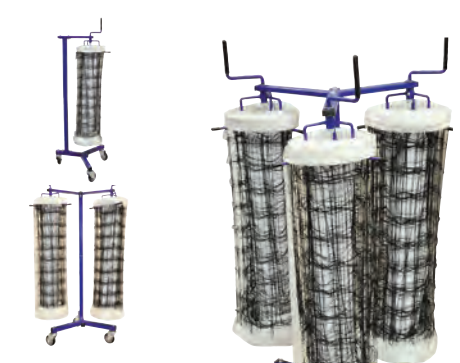

Jaypro® Net Keepers
Stores nets securely, neatly and easily in minimal space. Frames are constructed of 1.5" square steel tubing with 4" non-marring swivel casters. Each Keeper includes storage bags for nets.
33401 Single- holds 1 net; 20 lbs. \$229.99 ea.
33402 Double- holds 2 nets; 24 lbs..... 249.99 ea.
33403 Triple- holds 3 nets; 28 lbs. 287.99 ea.

Spalding® Rope Ratchet Package
Keeps your ropes tight!
Locking mechanism permits quick tightening of bottom ropes on net.
33080 \$40.99 pr.



Net Straps
Keeps net securely in place. Add tension to net with 1" Velcro® straps. Set includes 6 straps. Net Setter has 4 preset heights for accurate measuring.
33421 Net Tension Straps..... \$17.99 set
33226 Net Setter..... 7.99 ea.

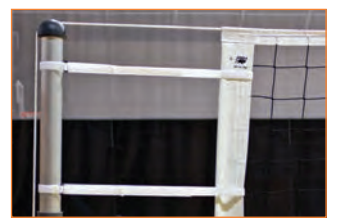

TIP & ROLL STANDARDS

Jaypro® Game Standards

Exclusive safety hub allows for easy assembly and prevents tampering!

- 2" diameter x 10' uprights
- Uprights are two piece for storage
- 24" diameter bases
- 2 sliding eye bolt collars per upright
- Bases have rubber rims to protect floor, 4" non-marring wheels for transport
- Extra drive for added safety
- Safety bolt is tethered to hub
- Ships by Truck

- 30145 Replacement Rubber Rim..... \$34.99 ea.
- 30146 Banding Kit- needed to replace rubber rim 43.99 ea.
- X30147 Royal Base Pad..... 149.99 ea.
- 30148 Single for Jaypro Standards \$1816.99 ea.
- 30149 Double for Jaypro Standards..... 26.99 ea.



Weight	Red	Yellow	Dark Green	Blue	White	Price
75 Lbs. Pair	T30211	N/A	N/A	T30221	N/A	\$634.99 pr.
75 Lbs. Each	T30212	N/A	N/A	T30222	N/A	389.99 ea.
145 Lbs. Pair	T30213	T30217	T30219	T30104	T30227	799.99 pr.
145 Lbs. Each	T30214	T30218	T30220	T30143	T30228	457.99 ea.
220 Lbs. Pair	T30215	N/A	N/A	T30204	N/A	999.99 pr.
220 Lbs. Each	T30216	N/A	N/A	T30144	N/A	574.99 ea.



TIP AND ROLL FOR EASY PORTABILITY

EASILY ADJUST THE NET HEIGHT WITH SLIDING COLLARS



EXCLUSIVE SAFETY HUB ON BASE



MORE COLORS ONLINE



GymGlide™ Recreational Game Standard

From gym to storage in 4 easy steps!

- Telescoping aluminum uprights
- Adjust height with lever release composite collars
- Lower upright height- no more tipping
- Powder coated cast iron base
- Base rides on retractable front swivel wheels
- 155 lb. base with holding capacity equivalent to standard 220 lb. bases
- Includes upper and lower collars • Ships by Truck

- T33418 \$714.99 ea.
- T33432 1,439.99 pr.



Easy Play Game Standard

It's easy to move because the weight never comes off the floor- just tip and roll!
 Unique main base is offset to maximize stability- 6 1/2" O.D. steel has a tough powder coat finish to resist scratches and can be filled with sand to provide 105 lbs. of ballast. The 2 piece upright is 10' high and is constructed of 2" O.D. galvanized steel. Includes sliding collar for a variety of net games. Net and other accessories sold separately. Available in royal blue only; shipping weight 67 lbs. Ships by Truck.

- T30062 \$312.99 ea.



Universal Pole Collar

Hang almost anything from any pole!

Collar can attach to any pole with a diameter of 1 1/2" - 6". When pulled tight the rubber sides of the hanger grab on tight and cannot be moved.

- 18256 \$37.99 ea.

Universal Pole Padding

Easy to install!

Pole padding is 72"H, fits up to a 2" diameter pole and is made from soft polyfoam with a heavy vinyl cover for durability. Hook and loop attachments make it quick and easy to install. Available in royal blue only.

- X30096 \$99.99 ea.



Universal Base Padding

24" or 30" diameter bases.

Complete base covering for maximum protection. Available in royal blue only.

- X30054 24" \$93.99 ea.
- X30055 30" 169.99 ea.

LIGHTWEIGHT STANDARDS

THE ZONE POWRBASE
Multi-Purpose Base System



ZONE POWRBASE Multipurpose Standard System

A unique, build-your-own system designed to fit your needs.

The POWRBase system features individual components that can be combined for numerous activities such as regular and no-peek volleyball, badminton, Net Ball and tetherball. Build single or multi-angled target walls with the optional crossbars and swivel joint. Connect multiple Zone target mats (see pg. 136) together to create an affordable gym divider. Available options include:

- X30247** 2 Bases, 2 Tall Posts, 1 Lightweight Net **\$279.99 set**
- X30248** 2 Bases, 2 Short Posts, 1 Lightweight Net **265.99 set**
- X30250** Complete System: 2 Bases, 2 Tall Posts, 2 Short Posts, 1 Lightweight Net **319.99 set**

Item #	Name	Description	Price
30244	Lightweight Net	Measures 20'L x 23"W. Remains square and taut	\$39.99 ea.
30253	Top Crossbar	Push pin locking system keep all pieces secure. Fits on top of 2 tall or short posts. Provides support for hanging targets or mats. "T" joint allows multiple systems to be connected straight across.	49.99 ea.
30242	Individual POWRBase	Tip N' Roll design. Made of durable PVC. Can be filled with water, sand or pea gravel. Single bolt system locks posts in place.	79.99 ea.
30240	Base and Short Post	Ideal for tennis up to badminton heights. Adjusts from 41" - 66"H.	129.99 set
30245	Base and Tall Post	Features a push pin locking system with pre-marked holes for men's, women's and junior's volleyball, and badminton heights. Adjusts from 61" - 95"H.	129.99 set
30251	Net Ball Hoop	Comes with rim and pole attachment.	139.99 ea.
30260	Swivel Joint	Allows two crossbar systems to be connected and placed at multiple angles.	14.95 ea.

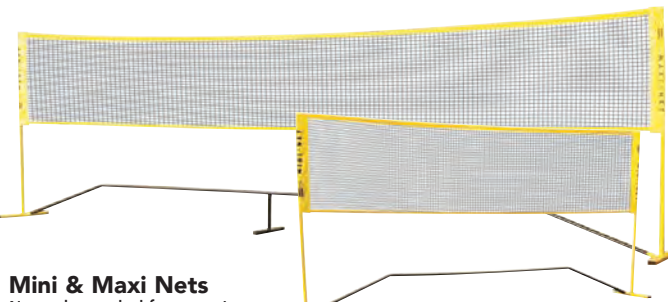

Mini & Maxi Nets
No tools needed for setup!

The Mini-Net and Maxi-Net portable net systems are revolutionary in quality, portability and price! Both nets set up and take down in just seconds with no tools needed and no bases to fill with sand or water. Heights are adjustable from 30"-52" for a variety of activities and lead up games. Both systems include a zippered carry case. The Mini-Net is 10' long with a 30" high net and the Maxi-Net is 18' long with a 30" high net.

- X15043** Maxi-Net, Adjusts from 30"-52"H x 18'L **\$119.99 SALE \$109.97 ea.**
- X15039** Mini-Net, Adjusts from 30"-52"H x 10'L **109.99 SALE 99.97 ea.**
- 15133** Maxi-Net, Replacement net **.36.99 ea.**
- 15085** Mini-Net, Replacement net **22.99 ea.**



Port-A-Net

A quick and easy 14' or 20' net system that can be set up anywhere.

Sets up in minutes. Both units have a 30" net that can be adjusted to a full 61" height for other over the net sports. Durable powder coated steel frame requires no extra weight for stability. The nylon-web adjustable strap at the top ensures quality net tension. The entire system fits easily into a durable nylon bag included.

- X41103** 30"-61" x 20' Net **\$129.99 ea.**
- X41104** 30"-61" x 14' Net **119.99 ea.**

VOLLEYBALL SYSTEMS



- PINK GRAY TAN BLACK PURPLE ROYAL NAVY
- KELLY MAROON ORANGE FOREST LIGHT BLUE RED YELLOW

Jaypro® Multi-Purpose PVB-134

3.5" O.D. aluminum uprights with infinite sliding height collars. High School net measures 32'L x 36"H w/33'10"L top cable.

- 30236 Uprights only..... \$1,454.99 pr.
- X30029 Upright Pads- specify color 556.99 pr.
- 33038 Flex Net-32'L x 39"H w/42' top cable... 499.99 ea.



CHECK PALOSSPORTS.COM FOR

- ✔ **MORE INFORMATION**
- ✔ **MORE SYSTEMS**
- ✔ **MORE BRANDS**

AVAILABLE WITH
PIN-STOP OR INFINITE
HEIGHT ADJUSTMENT



Jaypro® Power Steel PVB-1504

3.5" O.D. steel uprights with 16 pin stop height adjustment.

- 30235 Uprights only..... \$1,519.99 pr.
- X30029 Upright Pads- specify color 556.99 pr.
- 33038 Flex Net-32'L x 39"H w/42' top cable 499.99 ea.

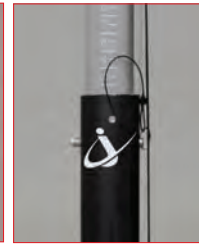

Second Floor T-Base Systems PVB-270UB & PVB-250UB

3.5" O.D. Aluminum uprights available with Infinite Height Adjustment or 16 Pin Stop Height Adjustment range of 6'6" to 8' 2".

- 30097 Uprights Only w/base-Infinite Height Adjustment \$3,199.99 pr.
- 30098 Uprights Only w/base-Pin Stop Height Adjustment 2,149.99 pr.



Jaypro® Featherlite PVB-514

3.5" O.D. aluminum uprights with 16 pin stop height adjustment.

- 300260 Uprights only \$2,099.99 pr.
- X30029 Upright Pads- specify color 556.99 pr.
- 33038 Flex Net-32'L x 39"H w/42' top cable 499.99 ea.

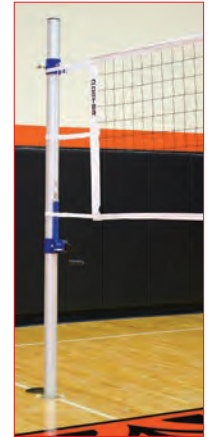

Porter® POWR-Rib II 01971-000

3.5" O.D. aluminum uprights provide infinite height settings.

- T30239 Uprights only: Ships by Truck ... **SALE \$1,467.97 pr.**
- X33339 Uprights Pads- specify color 589.99 pr.
- 33611 Universal Competition Net 47' Top cable... 269.99 ea.

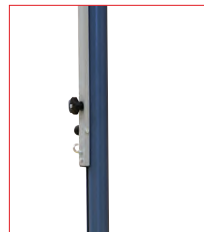

Spalding® Slide Multi-Sport 438-060

3" O.D. aluminum uprights with easy infinite height settings.

- T30007 Uprights & Antenna : Ships by Truck ... \$1,800.00 set
- X30125 Upright Pads-specify color. 564.99 pr.
- 30046 Net- 32'L x 36"H w/ 34' top steel cable ... 529.99 ea.



Spalding® Lite Steel 438-274

3" O.D. uprights weigh 34% less than other steel uprights.

- T30233 Uprights & Antenna : Ships by Truck \$2,155.00 set
- X30125 Upright Pads-specify color 564.99 pr.
- 30234 Net- 32'L x 36"H w/33' Aramid Fiber Rope . 484.99 ea.

ACCESSORIES

Jaypro® Official Standard Padding

6'H post pad constructed of 2" polyurethane foam and wrapped in 14 oz. vinyl available in your choice of color. Attaches to pole and base with hook and loop closure flaps.

- X30029 Standard Padding..... \$556.99 pr.
- 30028 Replacement Base Pad for T-base systems 369.99 pr.

PINK	GRAY	TAN	BLACK	PURPLE	ROYAL	NAVY
KELLY	MAROON	ORANGE	FOREST	LIGHT BLUE	RED	YELLOW



Jaypro® Folding Referee Stand

Blue powder coated finish, protective rubber tips and 4" non-marring wheels on the front for easy mobility.

Platform is 48" above the floor and stand folds flat at 84"H x 30"W x 10"D for compact storage. Frame style padding made out of heavy duty vinyl wrapped around 1" thick polyurethane foam. Please specify color from color chart to the left. Ships by truck.

- 30132 Folding Ref Stand \$702.99 ea.
- 30133 Padding- specify color..... 372.99 ea.



Jaypro® Wall Rack

Easy storage for volleyball posts.

Extremely simple to store volleyball posts. Premium heavy-duty steel rack attaches to wall and holds 3 posts in an upright position. Weighs 8 lbs.

- X30074.....\$239.99 ea.



Porter® Wall Storage Rack

New design for quick release!

Simple, yet secure use of thick web strap with Velcro® closure to keep uprights in place. Fits uprights from 3"-4" in diameter. Steel base plate with powder coat finish. Wall plate measures 12"L X 1.67"W.

- 33515\$104.99 SALE \$96.97 ea.



Spalding® Upright Storage Racks

Convenient and safe storage!

Made of 2" x 3" tubing and 1/8" bar stock. The locking rod is made of 1/4" cold rolled steel. Mounting holes in back plate are 16" on center. All parts are powder coated for long life. Racks will work with round or rectangular systems. Can be locked for security purposes (lock not included).

- X30075 3 Upright Rack.....\$179.99 ea.
- X30076 4 Upright Rack..... 219.99 ea.



Jaypro® Floor Sleeves & Anchors

Hinged covers to promote safety and plate lies flat on the floor when the uprights are in use. Sleeves are 3.5" I.D x 10" deep. Cover measures 7.5" O.D. and is made from cast brass or chrome.

- 30027 Brass \$489.99 pr.
- 30009 Chrome ... 489.99 pr.



Free Standing Judge's Stand

Free standing steel, black powder coated finish, with vinyl padded platform.

Non-marring casters provide easy transport. Stand can be used with any floor sleeved system. Padding is 1.38" thick with 15oz vinyl covering. Specify color. Black, dark green, grey, Kelly green, light blue, maroon, navy, orange, purple, red, royal blue, tan, white and yellow gold.

- X30223 Folding Stand..... \$345.99 ea.
- X30224 Padding- specify color . 329.99 ea.



Jaypro® Volleyball Equipment Carrier

An easier way to move and store heavy standards, nets and pads. Stores up to 6 standards, a dozen balls, 3 nets, 3 pairs of pads and antenna. 2 court carrier holds up to 4 standards along with the nets, pads and antenna. Ships UPS oversize.

- 30073 Court Carrier: Measures 4'L x 3'W; weighs 85 lbs. \$572.99 ea.
- 33405 2 Court Carrier: Measures 42"L x 32"W; weighs 51 lbs. 379.99 ea.



Net Winder & Antenna Cart

Horizontal storage makes it easier to roll out! Steel frame with non-marring casters. Stores 4 nets and 2 pairs of antennas. Nets & antennas sold separately.

- 30246 \$369.99 ea.

Volleyball Net Cart

A tangle free storage option! This PVC cart stores and safely transports up to 8 volleyballs, 6 nets and 12 antennas. Wide base, 3" rubber wheels. Measures 28"L x 24"W x 64"H.



LEATHER COMPOSITE FOOTBALLS

NFHS®

Wilson® Youth Leather

Approved for play in all major youth leagues. Full grain leather with multi-layered lining and 3 ply bladder for better air retention. Improved grip with composite leather laces and grip stripes.

- 32079 TDY Youth 12-14..... \$45.99 ea.
- 32082 TDJ Junior 10-12 45.99 ea.



C. Wilson® GST Leather

All weather leather football. Exclusive "WE Leather" with deeper pebble and firmer texture for ultimate control in the worst weather conditions. Patented ACL lacing, multi-layered lining, 3-ply bladder. NCAA and NFHS approved.

- 32005 Official size 14+ \$84.95 ea.



NFHS®

Rawlings® R2 Composite Leather

Soft touch technology. Features an aerial pattern with R-Grip composite stripes and rubberized lace.

- 32033 Official size 14+ \$36.99 ea.



Wilson® GST™ Composite

Replica of the GST ball with a composite cover. Composite microfiber cover with deep pebble grain, ACL™ laces, multi-layered lining to keep shape and butyl bladder for air retention.

- 32059 Official size 14+ \$39.95 ea.



Champro Composite 400

100% butyl bladder with "Air-Lock" valve. Synthetic leather cover with easy grip, great feel.

- 32000 Official size 14+ **SALE \$14.47 ea.**
- 32002 Youth 12-14 **SALE 14.47 ea.**
- 32006 Junior 10-12 **SALE 14.47 ea.**
- 32007 Pee Wee size 6-9 **SALE 14.47 ea.**



NFHS®

Wilson® TDS Leather

Meets NFHS ball specifications. Available in an exclusive "WE Leather" with a deep pebble grain or Ultimate Grip Composite Leather combined with ACL Lacing System for a better grip and control. Exclusive 3-ply bladder for superior air retention.

- 32092 Official size 14+ \$29.99 ea.

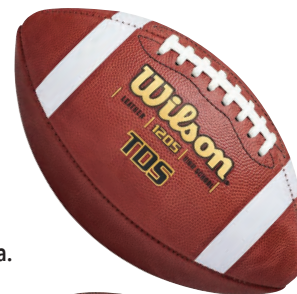

Wilson® All Pro Composite Leather

Super grip and feel with the NFL specifications. Composite leather cover and durable raised lacing for superior feel and control. The same "Fail Safe Lock Stitching" as used on the official game balls. Butyl bladder.

- 32070 Official size 14+ \$19.99 ea.
- 32071 Youth 12-14 19.99 ea.



Wilson® Youth Composite Leather

Approved for all youth league play. Ultimate Grip Composite Leather with a deep pebble grain and ACL Lacing System for a better grip and control. VPU bladder for superior air retention.

- 32073 TDJ Youth 12-14..... \$25.99 ea.
- 32072 TDY Junior 10-12 25.99 ea.
- 32074 K2 Pee Wee 6-9 25.99 ea.



Champro Composite 500

Deep pebble grain for grip. Easy grip premium composite cover with raised high tack. Better than leather lace.

- 32075 Official size 14+ **SALE \$18.47 ea.**
- 32076 Youth 12-14 **SALE 18.47 ea.**
- 32077 Junior 10-12 **SALE 18.47 ea.**



WHICH FOOTBALL IS RIGHT FOR YOU?

SIZE	9	8	7	6
	OFFICIAL	YOUTH	JUNIOR	PEE WEE
	AGES 14+	AGES 12-14	AGES 10-12	AGES 6-9
	11"L x 7" dia	11"L x 6.5" dia	10.5"L x 6" dia	10"L x 5.5" dia

RUBBER FOOTBALLS



PALOS PX-200™ Football

Budget friendly and long lasting! Nylon cord lining for shape and butyl bladder for soft feel and superior air retention. Deep pebble grain provides a sure grip wet or dry.

- 32012 Official size 14+ \$8.49 ea.
- 32013 Youth 12-14..... 8.49 ea.
- 32014 Junior 10-12 8.49 ea.



Mikasa® F5000

Premium waterproof rubber cover! Top of the line 2 ply butyl bladder keeps shape better. Super grip rubber molded laces provide a good grip for accurate throwing.

- 32100 Official size 14+ \$9.99 ea.
- 32101 Youth 12-14 9.99 ea.
- 32102 Junior 10-12 9.99 ea.



Mikasa® F5500

Made from Ultra-Grip composite rubber! With machine lock stitched panels and reinforced lacing for a great feel.

- 32138 Official Size 14+ \$14.99 ea.
- 32139 Youth 12-14 14.99 ea.
- 32140 Junior 10-12 14.99 ea.

RUBBER FOOTBALLS



ZONE POWRGRIP Footballs

Unsurpassed grip for greater control and enhanced accuracy.

POWRGRIP footballs are made with a dynamic cellular rubber cover. This construction offers a far superior tactile experience in the hand than any generic rubber football. The high quality wound bladder improves air retention and shape. Choose individual balls in traditional brown or colored balls in sets of 6.

- 50446 Traditional Brown- Youth 12-14 \$13.99 ea.
- 50447 Traditional Brown- Junior 10-12 13.50 ea.
- 50442 SET OF 6 Youth 12-14 79.99 set
- 50448 SET OF 6 Junior 10-12 79.99 set



ZONE POWRGRIP Train-A-Ball™

Designed for both right and left hand throwers.

Using the highest quality cellular rubber for maximum grip and durability shows the user how to properly grip the football when throwing.

- 32353 Junior 10-12 \$14.99 ea.



GRIP® Football

Tire tread design makes this rubber ball stand out!

The tire tread design has a great feel and won't slip when wet. Ideal for all ages!

- 32103 Junior 10-12 \$13.99 ea.



Franklin® Grip-Rite® 100 Football

Makes an ideal playground ball!

Rubber molded construction and waterproof pebbled cover. Raised rubber laces. Black/Lime.

- 10237 Junior 10-12 \$10.99 ea.



Tachikara® Mini Rubber Football

Rubber covered five-ply construction.

A fun mini size for younger kids with smaller hands.

- 32025 Mini size \$7.25 ea.



Grip Zone V™ Football

Excellent all weather ball!

The cover consists of a wrap around textured grip pattern with an alternating grippy vinyl section. Raised laces improve spiral tosses and make this an outstanding ball that's easy to throw and catch. Butyl bladder.

- 32332 SET OF 6 10.5" Grip Zone V™ \$109.99 set
- 32334 SET OF 6 8.5" Grip Zone V™ 101.99 set

AVAILABLE IN 2 SIZES



Champion® PG™ Rubber Footballs

Super tough cover with amazingly soft feel!

Easy to grip, safe to catch and fun to play with! The rubber cover is soft with a deep pebbled pattern and standard valve. Two tone color combination for better eye tracking. Available in a set of six.

- 37355 SET OF 6 Junior 10-12 \$59.99 set.



PALOS PX-200™ Rubber Footballs

Nylon wound, deep pebble grip for a quality yet affordable football.

These rubber footballs are available in three sizes to cover all ages and grade levels. Sold individually or in a set of 6 rainbow colors.

- 32040 SET OF 6 Official size 14+ \$53.90 SALE 47.97 set
- 32041 SET OF 6 Youth 12-14 53.90 SALE 47.97 set
- 32042 SET OF 6 Junior 10-12 53.90 SALE 47.97 set

Size	Red	Orange	Yellow	Green	Blue	Purple	Price
OFF.	32043	32044	32045	32046	32047	32048	\$8.99 ea.
YTH.	32053	32054	32055	32056	32057	32058	8.99 ea.
JR.	32062	32063	32064	32065	32066	32067	8.99 ea.

SOFT PLAY FOOTBALLS



Rhino SoftEEZE™ Junior Footballs
Tacky cover provides a great grip!
Combined with the rubber butyl bladder for softness and safety. Sold individually in assorted colors or in a set of 6. Measures 10.5"L.
10330 SET OF 6 \$69.99 set
10331 Assorted Colors 12.50 ea.



Soft Tip!
ZONE PX-9 Mini Foam Footballs
Textured, easy to grip exterior!
Unique material makes this football safe, soft and easy to grab. Indoors or out. Set of 6. Two-tone colors. Measures 7.5"L.
32361 \$59.99 SALE \$46.97 set



LATEX FREE!
ZONE SupR-Safe Footballs
Lightweight, soft, durable and easy to inflate.
Soft and safe and with a slight tacky feel, this ball is great for indoor or outdoor play. Measures 8.5"L..
32122 SET OF 6 SALE \$36.97 set
32104 Assorted colors 6.99 ea.

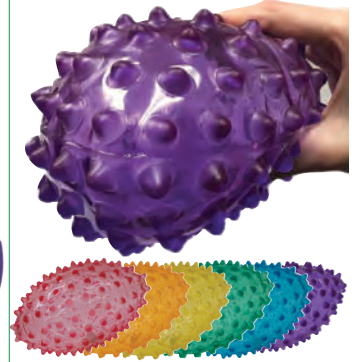

ZONE Clear Nobbie Football
Grabby™ texture gives it a great feel. Nobbie design gives it a great grip. They're easy to throw and catch, and the nobbie texture promotes play. Inflatable up to 12".
10135 SET OF 6 SALE \$22.97 set



2 YEAR GUARANTEE
PALOS RUFFSKIN™ Footballs
Super soft and safe!
Great soft feel, enough density in the foam to fly. Sold individually in assorted colors or in a set of 6. Size 3, 10.5"L.
10492 \$76.99 SALE \$66.97 set
10493 Assorted Colors 12.99 ea.



3 YEAR GUARANTEE
PALOS TUFFSKIN™ Footballs
Cover resists peeling and picking!
The most durable coated foam football on the market. Sold in assorted colors or in a set of 6. Size 3, 10".
10490 SET OF 6 \$94.99 set
10408 Assorted Colors 16.99 ea.



ZONE Spiral Foam Football
Two tone for easy eye tracking.
Nicely balanced feel with channels that fit your fingers comfortably. Ideal 9" long size with a 4.5" diameter for young hands. Sold in a set of six.
29000 \$44.99 SALE \$36.97 set
10219 Assorted colors 6.99 ea.



Poof® Foam Balls
Great for young players.
Molded laces and texture on the foam simulates the feel of a traditional football. Football is great for a fast paced, high-action game or to help improve catching, throwing and kicking skills without fear of getting hurt.
10805 Assorted Colors SALE \$7.97 ea.



Easy Grip Footballs
Soft touch, great feel!
Foam rubber construction with geometric panels and recessed valve. Soft tips for safety and ease of catching. Measures 9"L.
10396 SET OF 6 \$42.99 set



Gripper™ Football
Gripper™ mesh technology allows for non-slip catching!
Excellent ball for elementary play. Constructed with an ultra-light bladder and light nylon hand stitched cover.
10987 SET OF 6 \$101.99 set



Gripper™ Football
"Gripper™" mesh is non-slip for sure-grip catches. Constructed with an ultra-light bladder and light nylon hand stitched cover. The unique materials make this football non-threatening and safe for team sports or recreational play for all ages!
10991 8" \$17.99 ea.
10993 10" 19.99 ea.



Grip Zone V™ Football
Excellent all weather ball!
The Grip Zone material and design provides easy hand alignment and ball control, great for all users. Soft suede foam and mesh grip cover for an easy to catch introductory ball
32333 10.5" Assorted colors... \$18.99 ea.
32335 8.5" Assorted colors 17.99 ea.

FLAG FOOTBALL



ZONE Straps & Flags

Create a multitude of cooperative games! Straps are 2" wide with tabbed ends for easy removal, hook and loop design allows for multiple belts to be connected and multiple flags on each belt. Flags measure 15"L x 1.5"W and are made from nylon webbing with hook tabs for easy attachment to straps. Medium straps measure up to 44" and large up to 56".

BELT SIZE	RED	ORANGE	YELLOW	GREEN	BLUE	PURPLE	PRICE
MEDIUM	32194	32195	32196	32197	32198	32199	\$3.99 ea.
LARGE	32253	32254	32255	32256	32257	32258	4.99 ea.
FLAGS	32206	32207	32208	32215	32210	32211	0.99 ea.



ZONE 12 Belt Class Packs

Packs include 12 belts; 6 of each color, 36 flags; 18 of each color, and mesh bag.

BELT SIZE	YELLOW	BLUE	RED	GREEN	ORANGE	PURPLE	PRICE
MEDIUM	32260		32261		32262		\$79.99 pk.
LARGE	32263		32264		32265		89.99 pk.



ZONE 36 Belt Class Packs

Each pack includes 36 belts, 108 flags, and mesh storage bag. Includes 6 belts and 18 flags of each color.

32266	Medium 36 Belt Class Pack	\$239.99	pk.
32267	Large 36 Belt Class Pack	269.99	pk.

Shield Single Density Mouth Guard with Strap

Custom fit in 35 seconds! Comfortable for talking or breathing. One-piece quick release helmet strap. High quality dental vinyl.



18000	Clear	\$59.99 ea.	18254	Blue	59.99 ea.
18253	Black	59.99 ea.	18255	Yellow	59.99 ea.

Goal Pylons

Mark your goal line! Made from dense foam with a tough PVC covering, this set of 4 pylons have a weighted base and measure 18"H x 4.5"W.

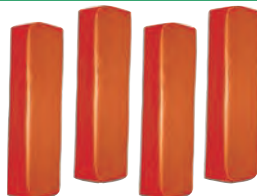

32023 Set of 4. \$29.99 set



True Flight Junior Football Set

Unique design helps prevent injuries during play! Rhino Skin® foam coated balls are tear resistant, easy to clean and sting-free. Unlike traditional footballs, these balls will not hurt if a catch is missed – thanks to the hollow core. Bright colors and an easy to grip hole pattern make them a great addition to adapted PE programs. Junior size 8.5"

17291 SET OF 6 \$64.99 set



Football 12" Sideline Marker Set

A set of 11 foam weighted sideline markers! Weighted, foam filled nylon reinforced vinyl markers with 12" numerals. Sets include two of each: Goal, 10, 20, 30, 40 and one 50 yard line marker.

32083	Black on Yellow	\$119.99	set
32336	White on Black	119.99	set
32337	White on Red	119.99	set
32338	Black on Orange	119.99	set

Kicking Tee

All rubber inter-collegiate kick off and place kicking tees.

32091	1"	\$3.15	ea.
32090	2"	3.25	ea.



Gilbert® Zenon Rugby Ball

Hand stitched training ball! All weather Hydratec® rubber cover with 3 ply poly cotton and cotton laminate construction. Great performance and long lasting.

32068	Official Size 5	\$19.99	ea.
32069	Intermediate Size 4	18.99	ea.



FLAG FOOTBALL

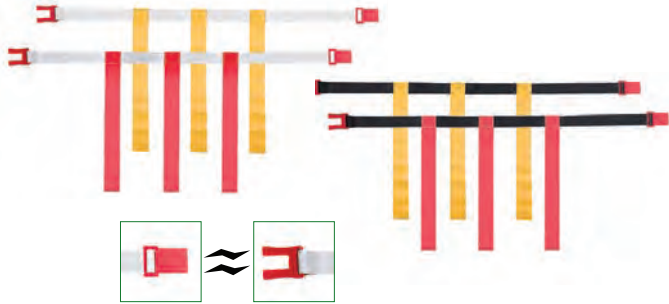

MAGNETS SNAP ENDS TOGETHER

NEW

Magnetic Flag Belts

Features a distinctive magnetic system which helps keep the belts secure.

Sleek buckle design is lightweight, and includes encased magnets, which make it easy to put on and pull-off. These durable belts, with sewn on flags, are ideal for schools and clubs. The magnetic system gives the player the ability to incorporate the belts into other gym activities or games. Sizes: (M) 26" – 38"; (L) 30" – 44"; (XL) 36" – 52". Set of 12.



- 32269 Medium, White belt - Red Flag \$51.99 set
- 32270 Medium, White belt - Yellow Flag 51.99 set
- 32271 Large, Black belt - Red flag 51.99 set
- 32272 Large, Black belt - Yellow flag 51.99 set
- 32273 X-Large, Gray belt - Red flag 51.99 set
- 32274 X-Large, Gray belt - Yellow flag 51.99 set



QUICKSTER® QB TRAINER 7X7

7' Ultra-Portable Passing Trainer!

Hit the numbers and practice like the pros to perfect your passing skills with three numbered passing targets. Taking only 90 seconds to fully assemble, with Tension-Tite Frame Technology, the net spans to a full 7' x 7'.

- X32268 \$134.99 ea.



Rip Flag® Heavy Duty Adjustable Flag Belts

One size fits all.

Constructed of heavy red, white and blue, vinyl. 52" universal fitting belts are electronically sealed to prevent fraying. Double D-ring Velcro® attachment is sewn to a heavy duty vinyl slide for adjusting proper playing position. Belt with 2-slides and 2-flags. Sold in sets of 6 (6-belts, 12-flags, 12-slides). Extra belts, flags, and slides are sold individually in dozen packs. Specify color.

- 32060 Extra belts (Red-White-Blue) \$29.99 dz.
- 32061 Extra slides 14.99 dz.

Item	Red	Yellow	Green	Price
Complete set of 6	32111	32112	32114	\$41.99 set
Extra Flags set of 12	32051	32052	32032	12.99 dz.

Rip Flag® Adjustable Flag Belt 24 Player Set

Includes a free nylon storage bag.

Includes 24 belts, 24 red flags, 24 yellow flags, 48 adjustable slides and a mesh storage bag.

- 32324 \$171.90 **SALE \$139.97 pk.**



Economy Flag Football Belts

Don't let the price fool you!

An excellent value! One size fits all. Sold by the dozen. Each set includes 12 belts, 24 slides and 24 flags. Replacement flags are sold in sets of 12 pairs. Each pair includes slides.

Item	Red	Yellow	Green	Blue	Price
Complete set of 12	32200	32201	32202	32203	\$22.99 set
Extra Flags set of 12	32181	32182	32183	32184	14.99 set

Economy Flag Belt 24 Player Set

Includes a free mesh storage bag.

Includes 24 belts, 24 red flags, 24 yellow flags, 48 adjustable slides and a mesh storage bag.

- 66439 \$49.90 **SALE \$41.97 pk.**



FLAG FOOTBALL

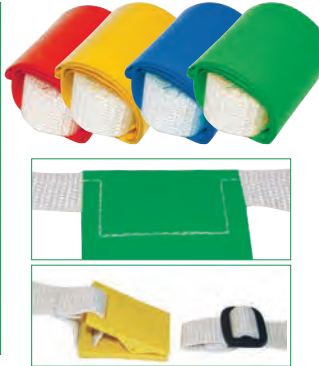

Triple Threat Flag Football Belts

One piece construction-no flags to lose, everything stays together!

Three heavy duty vinyl coated polyester flags are sewn permanently onto the strong web belt. Easy off polyethylene clip releases when flags are pulled. Available individually in 4 sizes and colors or 24 player packs.

Belt Size	Red	Yellow	Blue	Green	Price
20"- 32"	32160	32164	32141	32145	\$3.97 ea.
26"- 38"	32161	32165	32142	32146	
30"- 44"	32162	32166	32143	32147	
36"- 52"	32163	32167	32144	32148	

Middle School 24 Player Pack

Includes:

- 12 ea. of 20"-32" Flag Belts- 6 each red & yellow
- 12 ea. of 26"-38" Flag Belts- 6 each red & yellow
- 1 ea. 36113 White Mesh Storage Bag

66340 \$109.99 **SALE \$99.97 pk.**

High School 24 Player Pack

Includes:

- 12 ea. of 26"-38" Flag Belts- 6 each red & yellow
- 12 ea. of 30"-44" Flag Belts- 6 each red & yellow
- 1 ea. 36113 White Mesh Storage Bag

66341 \$109.99 **SALE \$99.97 pk.**



Flag-A-Tag

The flag that "Pops" on release!

The Flag-A-Tag has a unique concept where the flag is attached to a rubber socket and is inserted into another rubber plug worn on the belt. While in play the flag firmly stays on the belt, but when pulled off the belt a loud "pop" alerts everyone play should be stopped. Approved by the United States Flag and Touch Association and the International Women's and Men's Flags Football Association. Sold as complete units by the dozen. Each unit includes the belt, buckle, keeper, 2 flags and 2 sockets. **32322 Storage Ring-plastic ring holds 12- 18 belts \$5.99 ea.**

Belt Size	Red	Gold	Green	Blue	Price	Sale
42"	32302	32303	32316	32317	\$74.99 dz.	\$64.97 dz.
52"	32300	32301	32308	32310	74.99 dz.	64.97 dz.

Flag-A-Tag 24 Player Kit

Designed to outfit two teams of twelve players.

Includes 24 belts with flags and two storage rings.

Red/Gold-32320 Green/Blue-32321

42" Belt.....\$148.99 **SALE \$131.97 pk.**

Red/Gold-32318 Green/Blue-32319

52" Belt148.99 **SALE 131.97 pk.**



Tri-Flag Football Belts

Three flags sewn on quick release belt!

Affordable version of the 3 flag quick release belt systems. Nylon web belt with quick release clip and 3 vinyl flags. No flags to lose, easy to keep track of during play. Available in dozens or 48 player pack.

Belt Size	Red	Yellow	Price
25"- 31"	32126	32127	\$31.99 dz.
32"- 39"	32128	32129	

48 Player Pack

Includes:

- 1 dz. 25"-31" Waist 32126 Red
- 1 dz. 25"-31" Waist 32127 Yellow
- 1 dz. 32"-39" Waist 32128 Red
- 1 dz. 32"-39" Waist 32129 Yellow
- 1 ea. 36113 White Mesh Storage Bag

66434 \$122.95 **SALE \$111.97 pk.**



Qwik Flags™ Flag Football Belts

Easy off clip releases when flags are pulled!

Heavy duty vinyl flags are sewn permanently onto the strong web belt. No flag to lose- everything stays together! Sold in sets of 6 or 24 player packs.

Belt Size	Red	Yellow	Price
20"- 30"	32132	32133	\$28.99 set
28"- 38"	32134	32135	
36"- 46"	32136	32137	

Middle School 24 Player Packs

Includes:

- 2 sets of 20"-30" Flag Belts-1 set each red & yellow
- 2 sets of 28"-38" Flag Belts-1 set each red & yellow

66336 \$114.99 pk.

High School 24 Player Packs

Includes:

- 2 sets of 28"-38" Flag Belts-1 set each red & yellow
- 2 sets of 36"-46" Flag Belts-1 set each red & yellow

66337 \$114.99 pk.



BRINE® SOCCER BALLS



Brine® Attack

Quality ball priced for youth leagues and clubs. Soft durable PU cover and Air-Tight butyl bladder for maximum air retention. Designed for heavy use training. Sold individually or in a set of six.

50296 Set of 6, Size 5 \$119.84 **SALE \$82.97 set**
 50297 Set of 6, Size 4 119.84 **SALE 82.97 set**

SIZE	Red	Yellow	Green	Royal	Navy	Black	PRICE
4	50250	50251	50249	50257	50259	50248	\$13.99 ea.
5	50246	50247	50245	50253	50255	50244	



Brine® Attack 9 Ball Pack

Now available in all colors!
 Includes 9 Brine® Attack size 5 soccer balls and Soccer Ball Bag.

SIZE	Red	Yellow	Green	Royal	Navy	Black	PRICE	SALE
5	50073	50075	50076	50145	50169	50065	\$189.99 pk.	\$134.97 pk.



Brine® Evolution

A premium match and training ball. Four layer synthetic lining with super soft PU cover. Hand stitching and airtight bladder for uniform pressure dispersion and air retention. Size 5 only. Pack includes 9 Brine® Evolution size 5 soccer balls and a Soccer Ball Bag.
 50241 Brine® Evolution Soccer ball \$29.99 **SALE \$21.97 ea.**
 50062 9 Ball Pack w/Bag 279.99 **SALE 199.97 pk.**



Brine® Voracity NFHS®

Finished with a hand stitched abrasion resistant, soft PU cover.

An optimal game ball, the Tru-Bounce butyl bladder gives uniform dispersion and provides outstanding air retention.

SIZE	Black/White	Royal/White	Red/Blk/Wht	PRICE
5	50291	50305	50022	\$23.99 ea.



Brine® NCAA PhantomX NFHS®

#1 high school game ball or college practice ball. New and Improved!

Shiny, abrasion-resistant hand-stitched Duksung cover with a four-layer synthetic backing. HA Bladder for the best response, balance, playability and air retention.

SIZE	Black/Orange	Black/White	Royal/White	Scarlet/White	PRICE	SALE
5	50400	50397	50398	50399	\$39.99 ea.	\$33.97 ea.



NFHS®

Brine® Championship II Balls

The elite high school game ball with Eco softness.

Hand stitched ball features a premium glossy Eco soft hand-stitched cover with HA bladder system for the highest level of softness, balance and feel. NFHS approved.

SIZE	Black/White	Royal/White	Scarlet/White	PRICE
5	50100	50032	50031	\$49.99 ea.

WHICH SOCCER BALL IS RIGHT FOR YOU?

SIZE 5 JR HIGH & UP	SIZE 4 4TH - 6TH	SIZE 3 K-3RD
-------------------------------	----------------------------	------------------------

MIKASA® SOCCER BALLS



Mikasa® Soft-Play

Extremely soft synthetic leather cover. Responsive touch and feel, machine stitched seams and butyl bladder for maximum air retention. Recommended for all types of programs.

- 50381 SET OF 6 Size 5 \$77.90 **SALE \$71.97 set**
- 50382 SET OF 6 Size 4 77.90 **SALE 71.97 set**
- 50383 SET OF 6 Size 3 77.90 **SALE 71.97 set**

SZ	BLK	RED	OR	YE	GR	BL	PR	Price
5	50081	50041	50069	50376	50044	50066	50373	
4	50082	50042	50070	50377	50045	50067	50374	\$12.99 ea.
3	50279	50043	50071	50378	50046	50068	50375	

PACK OF 15 BALLS AND BAG!



Mikasa® Soft-Play™ 15 Ball Team Pack

Our most popular ball!
Includes 15 soccer balls and nylon ball bag.

SIZE	BLACK	RED	BLUE	PRICE	SALE
5	66436	66437	66438	\$209.99	\$192.97 pk.
4	66596	66597	66598		

Mikasa Kick-Off Brilliant

All weather construction. Hand stitched micro-fiber cover with butyl bladder for maximum air retention. NFHS approved. Size 5. 50407 \$36.99 ea.



NFHS®

Mikasa® La Estrella Plus

A hand stitched game ball. Made with an abrasion resistant PU cover and butyl bladder for maximum air retention. NFHS approved. Size 5, black/white only. 50277 \$21.99 ea.



Mikasa Aura

Neon honeycomb design! Cushioned polyurethane cover for softer feel and greater control. Butyl bladder for maximum air retention. Ideal youth ball.

- 50418 Set of 4 Balls one of each color- size 5..... \$63.99 set
- 50419 Set of 4 Balls one of each color- size 4..... 63.99 set

SIZE	YELLOW/BLK	ORANGE/BLK	GREEN/BLK	BLUE/BLK	PRICE
5	50410	50411	50412	50413	
4	50414	50415	50416	50417	\$16.99 ea.

WILSON® SOCCER BALLS

Wilson® Stivale

Use as a game ball or for recreational play! TPU composite leather cover with fused panels and high rebound butyl bladder. NFHS approved. Size 5. 50048 \$29.99 ea.



Wilson® NCAA Forte™ Fybrid™ II

Aerodynamic stability and control! Fybrid™ panel technology minimizes moisture intake for extended durability. Constructed with a composite leather cover, internal carcass that keeps a round shape and an Elastomeric-Carbon bladder for superior rebound. Size 5. 50996 Optic Green/Royal..... \$99.99 ea. 50319 Royal/White..... 99.99 ea.



CHAMPION® SOCCER BALLS

NEW

Champion Sports SS

Hand-stitched soft touch cover with extra cushioning for safe play. 5-Ply nylon custom butyl bladder for exceptional air and shape retention. Bright fluorescent colors. Indoor/outdoor use.

- 50449 Size 5 - Neon Green..... \$16.99 ea.
- 50450 Size 4 - Neon Orange..... 15.99 ea.



NEW

Champion Sports Extreme Tie Dye Soccer Ball

All weather ball can stand up to wet conditions. Soft-touch composite TPU cover does not compromise power and weight. Butyl bladder for superior air retention. Machine stitched panels for added durability. Can stand up to all weather outdoor play.

- 50451 Size 5..... \$9.99 ea.
- 50452 Size 4..... 9.99 ea.
- 50453 Size 3..... 9.99 ea.



CAMP SOCCER BALLS

Machine Stitched Soft Soccer Ball

Unique foam lining in panels. Premium PVC synthetic cover with a foam lining underlay for soft, responsive feel. Machine stitched panels butyl bladder for great air retention. Available in 3 sizes..

- 50176 Size 5..... \$11.99 ea.
- 50177 Size 4..... 11.99 ea.
- 50178 Size 3..... 11.99 ea.



Retro Soccer Ball

Classic look with modern construction! Ideal club or practice ball with a TPU cushion cover, 2 ply butyl bladder and 32 machine stitched panels.

- 50315 Size 5 \$9.99 ea.
- 50316 Size 4 9.99 ea.
- 50317 Size 3 8.99 ea.



Extreme Soccer Balls

Patented machine technology construction. Machine stitched and constructed with "Soft Touch Composite" PU cover and butyl bladder for better air retention.

- 50133 SET OF 6 Size 5..... \$58.99 set
- 50134 SET OF 6 Size 4..... 58.99 set



Tachikara Soccer Balls

Versatile ball for indoors or out! Synthetic soft leather stitched cover with butyl bladder and bright colors.

- 50140 SET OF 6 Size 5 \$73.99 set
- 50105 SET OF 6 Size 4 73.99 set

RUBBER SOCCER BALLS



ZONE POWRGRIP Soccer Balls

Excellent feel and durability! Cellular Rubber construction gives balls a cushioned feel with a Japanese wound bladder for improved shape and air retention. Extremely durable for heavy use.

- 50443 SET OF 6 Size 5..... \$79.99 SALE \$64.97 set
- 50444 SET OF 6 Size 4..... 79.99 SALE 64.97 set

SIZE	RED	ORANGE	YELLOW	GREEN	BLUE	PURPLE	PRICE
5	50204	50205	50206	50207	50208	50209	\$7.99 ea.
4	50210	50211	50212	50216	50217	50218	7.99 ea.
3	50219	50223	50224	50225	50226	50227	7.99 ea.

ZONE POWRGRIP Outdoor Soccer Ball

Unique tire tread cover holds up to all weather and surfaces! Performs like a regular soccer ball. High grade natural rubber cover offers superior grip and extreme durability. Japanese nylon butyl bladder for maximum shape/air retention. Indoor/outdoor use.

- 50434 Official Size 5 \$11.99 ea.
- 50435 Intermediate Size 4 11.99 ea.



ZONE SupR-Safe Soccer Ball Set

Soft and safe with a slightly tacky feel! This ball is made from a foamed rubber process that is lightweight, durable and easy to inflate. Size 4 only.

- 10066 SET OF 6 \$36.99 SALE \$29.97 set



PALOS PX-200™ Rubber Soccer Balls

Three sizes at an affordable price. These quality nylon rubber colored soccer balls are a great addition to your current color theme.

- 50170 SET OF 6 Size 5 \$47.90 SALE \$39.97 set
- 50171 SET OF 6 Size 4 47.90 SALE 39.97 set
- 50172 SET OF 6 Size 3 47.90 SALE 39.97 set



Voit® Rubber Soccer Ball

A tough rubber ball! Nylon winding, 2-ply butyl bladder, waterproof, 32-panel design. Available in sizes 4 and 5.

- 50237 Size 5 \$11.99 ea.
- 50238 Size 4 11.99 ea.

TRAINING SOCCER BALLS

40" CLOTH COVERED OVERSIZED BALL



ZONE Oversized Soccer Ball

You'll get a kick out of this giant sized ball. Made with washable polyester covers and durable vinyl bladders, these balls will withstand heavy play. Great for crab soccer, field days, group volleyball and push ball games. Available in two styles - volleyball and soccer. **CHOKING HAZARD (6) - BALLOON.** Not for under 8 yrs.*
 10323 40" Soccer Ball \$89.99 **SALE \$79.97 ea.**
 10807 Replacement Bladder for 40" Playballs 38.99 ea



30" CLOTH COVERED LIGHTWEIGHT BALL



ZONE 30" Cloth Ball

Bouncy and lightweight! Twill cloth cover with Velcro® closure. Includes 1 latex bladder and string tie off. **CHOKING HAZARD (6) - BALLOON.** Not for under 8 yrs.*
 10578 \$41.99 **SALE \$34.97 ea.**
 10579 Replacement bladder only 7.99 ea



MAC-T Soft Play Soccer Balls

Soft and sting free. Durable double knit polyester cover over a foam layer and butyl bladder. Sold in a set of six.
 50234 SET OF 6 Official Size \$66.99 set



NEW

Champion Sports Pebble Tek Soccer Balls

Pebble-Tek finish for a lightweight feel & classic soccer ball design. Rhino Skin® inflatable foam coated ball for exceptional tear resistance. Does not hurt on impact. Size: 8.5"D. Set of 6.
 50454 \$82.99 set



Rhino SoftEEZE™ Soccer Balls

Easy to grip tacky cover! Rubber butyl bladder for softness and safety. Sold in a set of six.
 10195 SET OF 6 Size 4 \$89.99 set



ZONE Soft Kick Soccer Ball

Great feel and rebound! Soft cushioned cover with butyl bladder for air retention. 8" diameter ball.
 10239 \$12.99 **SALE \$9.97 ea.**



Soccer Training Ball

A 20% lighter weight ball! Teaches younger children without fear. Constructed of hand sewn vinyl covered nylon. Size 4.
 10230 \$11.99 ea.



ZONE Dimple Soccer Ball

Dimple design for extra grip and improved control! Constructed from durable rubber with reinforced valve. Size 4 only.
 10199 SET OF 6 \$39.99 set

Tye Dye Gripper™ Soccer Balls

Easy to grip! Nylon hand stitched cover with Gripper mesh panels. Ultra light bladder.
 10996 6" \$13.99 ea.
 10989 8" 18.99 ea.
 10990 10" 19.99 ea.



* Full CHOKING HAZARD descriptions on page 355.

FOAM SOCCER BALLS



PALOS TUFFSKIN™ Soccer Ball

Dense foam soccer ball with TUFFSKIN™ coating.

The most durable foam soccer ball on the market. Size 4.

- 10439 SET OF 6 7.5" \$129.99 set
- 10480 Assorted colors 22.99 ea.



PALOS RUFFSKIN™ Soccer Ball

An excellent value ball with RUFFSKIN™ coating.

Heavy vinyl, peel resistant coating. Size 4.

- 10481 SET OF 6 7.5" \$81.99 SALE \$71.97 set
- 10482 Assorted colors 14.99 ea.



ZONE Foam Soccer Balls

Great feel, great look!

Nice density 8" foam ball covered with a thick vinyl cover. Sold in a set of six.

- 59004 SET OF 6 \$64.99 SALE \$51.97 set



Poof® Foam Soccer Ball

Eye catching colors!

Soft, safe foam ball with vinyl cover. Each ball measures 7.5", size 4.

Colors/designs will vary.

- 10806 \$9.99 ea.
- 10804 Set of 6 (colors will vary) 55.99 pk.

INDOOR SOCCERBALLS



ZONE Indoor Felt Soccer Balls

Lighter weight design!

Soft felt cover with rubber seams and butyl bladder. Available in a set of 6 colors in 2 sizes or individually in yellow only.

- 50232 SET OF 6 Size 5 \$54.99 set
- 50233 SET OF 6 Size 4 42.99 set
- 50072 Yellow only - Size 5 13.99 SALE 10.97 ea.



Voit® Indoor Soccer Balls

Balanced for shape retention!

This ball bounces and rolls true with a soft touch. Molded felt cover with nylon windings and a 100% butyl bladder.

- 50083 SET OF 6 Size 5 \$109.99 set
- 50215 Size 5 Yellow \$22.99 ea.
- 50084 SET OF 6 Size 4 109.99 set
- 50214 Size 4 Yellow 22.99 ea.



Brine® Evolution Futsal

Official size indoor low bounce ball.

Soft and durable synthetic cover for optimal use in Futsal matches and training. Low bounce, air tight bladder for superior playability.

- 50052 \$20.99 ea.



Mikasa® Futsal Ball

American Futsal model.

Deluxe stitched cushion cover with high grade bladder delivers low bounce. Official size 4.

- 50321 \$21.99 ea.



Mikasa® American Futsal Ball

Excellent feel on the foot.

Official size 4 with deluxe stitched cushion cover. Low bounce ball with a great bladder.

- 50144 \$21.99 ea.



Brine® Evolution Court

Optimal for hard court surfaces or indoor play!

Sueded microfiber composite cover with an air tight butyl bladder. Size 5.

- 50229 \$20.99 ea.

ACCESSORIES



ZONE

Telescopic Agility Stick

Spring loaded spike for safety. The 1.375" diameter plastic pole telescopes to a maximum height of 64" tall. Sold in a set of six.

54208 Set of 6.....\$71.90 **SALE \$44.97 set**



ZONE Deluxe Spring Loaded Corner Flag Set

Spring loaded steel base gives on contact for player safety. The PVC upright is 1" O.D. x 60" high with attached official red flag and steel peg.

50017 Set of 4 \$49.99 **SALE \$43.97 ea.**

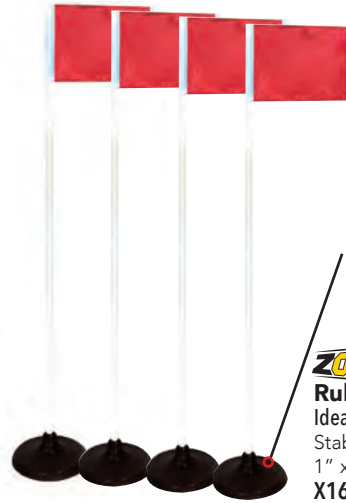

RUBBER BASE FOR ALL SURFACES!

ZONE

Rubber Base Corner Flags

Ideal for turf or indoor play. Stable rubber base with 1" x 60"H pole and flag.

X16578 Set of 4.. \$42.99 **SALE \$34.97 set**

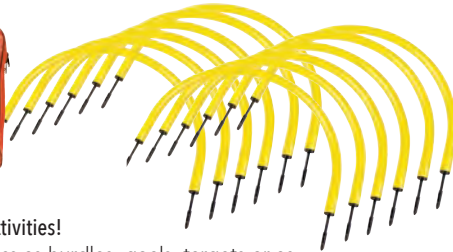

Passing Arc Set

Great for many different activities!

Use this set of 12 PVC arcs as hurdles, goals, targets or as part of an obstacle course. Metal stakes secure arcs into ground. Nylon storage bag included. 20"W x 12"H.

50309\$62.99 set



Half Cone Class Pack

36 half cones and a carrying rack. Six of each color: red, yellow, green, blue, purple and orange.

21025\$29.99 **SALE \$23.97 set**

NEW

ZONE Duffel Bag

A mesh/canvas combo for easily identifying equipment.

This bag can hold at least 20 soccer balls. It is made of canvas with a vinyl backing for strength and a strong porthole mesh middle section. Features include a drawstring top and heavy duty shoulder strap. Measures 42"L x 20"W.

36288 SET OF 6\$89.99 set

36270 Single Red/Black Bag 15.99 ea.



ZONE Soccer Ball Bag

Holds up to 10 soccer balls!

Nylon construction with mesh insert panels, reinforced bottom, drawstring closure and nylon web shoulder strap. Measures 24" high with 21" diameter.

36090\$14.99 ea.

66728 3 Pack 30.99 ea.



Goalie Glove

Elastic wrist with adjustable strap! Latex foam palm for durable grip with Air-Flow material for increased comfort.

- 16817 Youth S (5)
- 16819 Youth L (7)
- 16818 Youth M (6)
- 16820 Adult S (8)

Specify Size\$14.50 pr.



Stopper Goalie Glove

A perfect cut for smaller hands! Made of nylon with dimpled rubber palm and finger tips for extra grip with an adjustable velcro strap for sure fit.

- Youth S-50137
- Youth M-50138
- Youth L-50139

Specify Size\$8.99 pr.



Soccer Shin Guard

Our most popular shin guard. Lightweight design with an outside shell made of a hard plastic and bonded to a comfortable foam backing. Attaches with velcro.

50115 8" w/velcro strap.....\$4.50 pr.

50116 7" w/velcro strap..... 4.25 pr.

PRACTICE GOALS



**QUICK & EASY
POPUP
GOALS!**

ZONE Pop Up Goal

One of the best pop-up goals on the market!

Heavy frame twists and folds to open and close. Heavy reinforced net sleeves with flexible wire retains shape. No assembly required, just twist and you have your goal. Includes carry bag.

54199 48"W x 40"H x 37"D..... **\$59.99 SALE \$49.97 pr.**



ZONE Super Shot Soccer Goal

Quick and easy assembly.

Excellent practice goal. No tools or heavy steel crossbars are required. Includes special clips to attach the net to the durable light weight FRP rods. Indoor/outdoor use.

50834 6' x 4'..... **\$94.99 SALE \$79.97 ea.**



Quickster™ Soccer Goals

Portable quick set up goals!

Featuring composite steel and fiberglass Tension-Tite™ frame with click to lock tubing, quick wrap Velcro® straps, heavy tarpaulin facing and strong 2 ply netting with 4" x 4" openings. Assembles quickly and easily and includes a carry bag and ground stakes.

X50008 6' x 4' Goal 9 lbs..... **\$71.99 ea.**

X50195 12' x 6' Goal 18 lbs..... **134.99 ea.**



PowerNet® Soccer Goals

No tools required!

Only takes 3 minutes to set up! Completely portable with a unique frame that flexes with each hit resulting in a stable base. Capable of handling shots from pro players! Includes bungees, ground stakes and carry bag.

50401 4' x 6' x 2.3' - 15 lbs..... **\$99.99 ea.** **X50404** 7' x 14' x 3.3' - 30 lbs..... **\$199.99 ea.**

50402 4' x 8' x 2.7' - 20 lbs..... **99.99 ea.** **X50405** 6.5' x 18.5' x 4' - 43 lbs..... **289.99 ea.**

50403 6' x 12' x 3.2' - 27 lbs..... **139.99 ea.** **X50406** 8' x 24' x 3.3' - 76 lbs..... **499.99 ea.**



**QUICK & EASY
POPUP
GOALS!**

Rectangular Pop Up Goals

Pop up technology for fast set up and collapses for easy take down. Includes ground stakes and carry bag for transport and storage. Ideal for practice goals, fun play in the gym and ball receptacle for fast moving games!

X50740 72"L x 48"W x 48" deep Sold in pairs..... **\$99.99 pr.**



Blackhawk Portable Soccer Goals

Twist and fold design pops up and is ready to go!

Made from lightweight fiberglass and steel construction with a sturdy netting. Use for indoors or outside. Includes peg hooks for anchoring and carry bag. Assembly required.

X50384 6' x 3'..... **\$38.99 ea.**

PRACTICE GOALS

**QUICK & EASY
POP UP
GOALS!**

ZONE Pop Up Goal

A quick set up, take down portable practice goal.

Newly designed portable pop-up goal with polysteel frame construction and gusseted, nylon corners. Elastic anchor tethers and Velcro fasteners to hold in folded position. Polyester 8mm mesh net. 3 nylon anchor pegs per goal. Storage bag included.

- X50721 72"W x 42"H Sold in pairs \$69.99 **SALE \$59.97 pr.**
- X50738 48"W x 32"H Sold in pairs \$59.99 **SALE 48.97 pr.**
- 50817 30"W x 18"H Sold in pairs..... \$37.99 **SALE 29.97 pr.**



Pugg® Six Color Goal Sets

Great for group games!

Lightweight goals with durable mesh netting, reinforced net sleeves and flexible wire that twists and folds down for storage. Set of 6 goals includes anchors and 3 carry bags. Available in 2 sizes.

- X50825 6'W x 3.5'H \$264.99 set
- X50826 4'W x 2.5'H 184.99 set

Pugg® Goals

Sets up and folds down in seconds!

Lightweight and portable, these goals are constructed with reinforced net sleeves and flexible wire. Includes carry bag and anchoring pegs. Available as a set of 2. 2.5"W goal available in a set of 2, one black and one gold.

- X50815 6'W x 3.5'H (pair)..... \$87.99 pr.
- X50816 4'W x 2.5'H (pair)..... 61.99 pr.
- X50749 2.5'W x 1.5'H (pair)..... 49.99 pr.

Ultra Q5 Weighted Pop-Up

The ULTRA series is the top choice of elite coaches and players.

This All-Terrain Portable Goal is made of a heavier denier nylon. Greater durability to perform on turf, pavement, dirt, gym floors, or natural grass. Fully-integrated weights for maximum stability and a 3-peg system for anchoring.

- X50997 3' weighted goal (pair)..... \$56.99 pr.
- X50998 5' weighted goal (pair)..... 99.99 pr.



NEW

Karben Sports 4'x3' Multi-Use Folding Goal

Innovative goal folds down for storage and portability.

Industrial-grade PVC frame construction will not crack and splinter like lower quality goals. Weatherproof and UV resistant to fading. Includes removable uprights, which can be used to play additional games, and removable back stability bars. Dimensions: 47.5"L x 34"H x 34"D. Weight: 8.5 lbs.

- 50455 \$154.99 ea.



TriGoal™ Net

The Original Goal For Circular Soccer!

Made from pop wire and nylon technology, the TriGoal™ simply twists and folds for easy set up and storage. Unique top zipper feature quickly aligns the net and reinforces stability. Includes 6 steel pegs to use on grass and 3 rubber weights for indoor or turf play. The 3 sided net measures 48"W x 39"H. Includes three 8" diameter starting spots and twelve 8" boundary spots. Includes carry bag and directions to play Circular Soccer. Use as a shooting target- get more players involved in a smaller space or simply create passing and shooting games. Activity sheet included for alternative games.

- 16580 \$109.99 **SALE \$89.97 ea.**

THE ZONE POWRPRO PREMIUM GOALS

FEATURES*

- USE INDOORS OR OUT
- FAST AND EASY ASSEMBLY
- JOINTS WITHSTAND UP TO 200 LBS.
- SUPER DURABLE NETTING

*Features vary by model

STRONG REINFORCED CORNERS

STEEL CROSSBAR

TWIST TIGHT JOINTS



STEEL FRAME

THE ZONE POWRPRO Pro Series Soccer/Hockey Goal

Go from soccer to hockey with a simple change of the net!

Maximize your budget with this versatile, indoor or outdoor goal. Choose from the Soccer/Hockey package that includes two nets, or the single net soccer goal. Made of heavy-duty 1.25" diameter steel frame, reinforced PVC corner joints and twist tight connectors. 6'L x 51"H x 36"D.

HOCKEY NET SOCCER NET



- | | | |
|--------------------------------------------------------------|----------|-------------------------|
| 54282 Soccer Goal, Braided 4" Mesh Net Only | \$110.99 | SALE \$89.97 ea. |
| 54290 Soccer/Hockey, 1 Frame, 2 Nets | 126.99 | SALE 99.97 ea. |
| 54287 The Zone Twisted 1.75" sq. Mesh Net (Fits 54282) | | 14.99 ea. |
| 54287 The Zone Twisted 1.75" sq. Mesh Net (Fits 54282) | | 14.99 ea |



THE ZONE POWRPRO 3 in 1 Training Goal/Rebound Set

Train like a pro with 3 different setups!

This set features a 4" sq. soccer net for pro style training and game play, a rebounder net to improve ball control, and a target to develop shooting accuracy. Easy bungee net attachment system. 2" PVC frame. Includes 8" soccer ball, hand-pump, needle and 6 metal stakes. Measures 6'L x 51"H x 36"D.

54285 **\$129.99 set**



THE ZONE POWRPRO Junior Soccer Goal Set

A smaller version for youth play that is super fast and easy to assemble!

Includes everything you need to train or play small sided games. Includes 2 PVC goals, 6" soccer ball, hand pump, needle, and 8 ground stakes. Use goals indoors or outside. Measures 30"L x 24"H x 18"D.

54286 **\$39.99 pr.**



STEEL FRAME

THE ZONE POWRPRO Pro Series 2 in 1 Goal

Excellent practice goal for soccer or floor hockey! Premium reinforced PVC corners will not blemish gym floors making this goal ideal for outdoors and well as inside. Durable 1.25" diameter steel frame. Includes a braided 2" sq. mesh net with easy-on hooks and 4 metal stakes. Measures 42"L x 36"H x 24"D.

- | | |
|--------------------------|--------------------|
| 54283 | \$64.99 ea. |
| 66779 Pair of Goals..... | 124.99 pr. |



STEEL FRAME

THE ZONE POWRPRO Pro Series 8ft Soccer Goal

Designed with reinforced PVC corners and joints! Great for outdoors as well as inside. Will not mar gym floors. Frame is made of 1.25" diameter, powder coated steel, and sturdy twist-tight connectors. Includes a twisted 4" sq. mesh net with easy-on hooks and 9 metal stakes. Measures 8'L x 6'H x 42"D.

54281 **\$124.99 SALE \$104.97 ea.**

GOALS



AVAILABLE IN 6 SIZES

Gared® Touchline Galactico Club/Practice Goals
Smaller 3" round frame is perfect for recreational leagues, youth games, and practices!

Traditional backstays are constructed of two-piece tubular steel and stabilizing ground bar and stakes. Includes hardware, net clips and ground anchors. Choose from white powder coated or natural finish. See website for details and pricing on the natural finish goals. Ships via truck.

Item	LBS	SIZE	Price
T59124	170	2mm 4'H x 6'W	\$990.00 pr.
T59123	191	3mm 4.5'H x 9'W	1,170.00 pr.
T59122	311	3mm 6.5'H x 12'W	1,260.00 pr.
T59121	389	3mm 6.5'H x 18.5'W	1,530.00 pr.
T59120	419	3mm 7'H x 21'W	1,620.00 pr.
T59119	518	4mm 8'H x 24'W	1,710.00 pr.



Jaypro® Roll-A-Goal

A great folding goal to use indoor or outside!

Made of 1 5/8" O.D. steel frame that folds flat for compact storage and non-marking front wheels for easy transport. Includes durable knot less nylon net with sleeves that attach with hook and loop.

- 50320 2'H x 3'W \$117.99 ea.
- 50717 3'H x 4'W 169.99 ea.
- 50718 4'H x 6'W 219.99 ea.



Franklin® Steel Soccer Goals

Excellent for practice, PE classes and mini tournaments!

Made from 1.25" diameter galvanized steel tubing with precision fit locking pins for easy and secure assembly. Includes 4" x 4" durable PE net and ground stakes.

- X50166 4' x 6' x 3' \$59.99 ea.
- X50168 6' x 12' x 5' 129.99 ea.



Jaypro® Steel Folding Goals

Now powder coated for extra protection!

Lightweight, easy to fold and easy to transport. Made with 1 5/8" O.D. galvanized steel frame with powder coat finish, snap pins to lock the frame in place, rear ground crossbar for added stability, ground anchors and includes a 2.5 mm twisted 5.5" sq. mesh net with net ties. Indoor floor protector kit sold separately. Ships by truck.

- T50763 4' x 6'W 24 lbs. \$249.99 ea.
- T50764 5' x 10'W 36 lbs. 259.99 ea.
- T50765 6' x 8'W 36 lbs. 259.99 ea.
- T50766 6' x 12'W 41 lbs. 324.99 ea.
- 50767 Floor Protector Kit 26.99 ea.

Mylec® Ultra Pro II Soccer Goal
Weighted bottom tubes for added stability!

Assembles in minutes with PVC tubing and a heavy duty sleeve netting system. Ideal multi-purpose goal for indoor or outdoor use. Measures 4'H x 6'W x 5' deep.

- X50054 \$79.99 ea.



Jaypro® Indoor/Outdoor Folding Soccer Goal and Net
This uniquely designed goal provides unequalled performance and versatility.

Frame is made of rugged powder coated 2" O.D. galvanized steel tubing with 15/16" O.D. galvanized steel backstays that fold and lock for convenient storage without having to remove the net. Includes 1 pair of 4" sq. mesh 2.5 mm orange polyethylene nets. Measures 7'H x 12'W x 4'D. Ships by truck.

- T50028 \$683.99 pr.



OFFICIAL GOALS



OFFICIAL ROUND



OFFICIAL SQUARE



Packages Include: • 5.5" square 4mm white mesh nets • 8 steel 18" auger anchors • Classic Goal Wheel Kit

Jaypro Classic™ Soccer Goals Packages

Meets NFHS, NCAA and FIFA specifications

- 8'H x 24'W x 4'B x 10'D
- Square front 4" x 4" extruded aluminum
- Round front 4" O.D. extruded aluminum
- 1.9" O.D. galvanized steel back-stays
- 1.9" O.D. galvanized steel rear crossbar
- Requires 140 lbs. of counter weight per goal on turf
- Ships by Truck

T50827 4" x 4" Square Portable Goals - 500 lbs. **\$3,039.99 pr.**

T50828 4" Round Portable Goals - 496 lbs. **3,399.99 pr.**



WHEEL KIT



Hexagonal Pattern

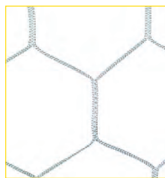

Braided P.E.



Twisted P.E.

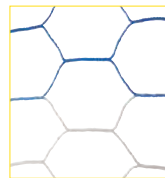

Braided Knotless Hex

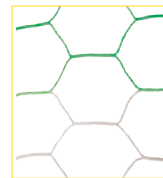

Braided Knotless Hex

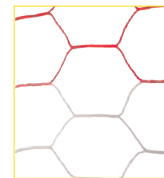

Braided Knotless Hex



Braided Knotless Hex

Soccer Nets

For all 24'W x 8'H x 10'D goals.

Item	Rope	Construction	Mesh	Color	Price
50001	6mm	Braided knotless hex	4" hex	Wht.	\$299.99 SALE \$276.97 pr.
50030	6mm	Braided P.E.	4" sq.	Orange	305.99 SALE 279.97 pr.
50004	6mm	Braided P.E.	4" sq.	Wht.	305.99 SALE 279.97 pr.
50005	4mm	Braided P.E.	4" sq.	Orange	189.99 SALE 177.97 pr.
50006	4mm	Braided P.E.	4" sq.	Wht.	189.99 SALE 177.97 pr.
50009	3mm	Twisted P.E.	4" sq.	Orange	148.99 SALE 139.97 pr.

NOW OFFERING TWO-TONE HEXAGON NETS IN 4 COLORS!

Item	Rope	Construction	Mesh	Color	Price
50007	3mm	Twisted P.E.	4" hex	White	\$49.99 pr.
50011	2mm	Twisted P.E.	4" sq.	Orange	89.99 pr.
50012	2.5mm	Twisted P.E. 12'x7'x4'	5" sq.	Orange	49.99 pr.
50821	5mm	Braided knotless hex	5.5" hex	White/Blue	299.99 pr.
50822	5mm	Braided knotless hex	5.5" hex	White/Green	263.99 pr.
50823	5mm	Braided knotless hex	5.5" hex	White/Red	299.99 pr.
50824	5mm	Braided knotless hex	5.5" hex	White/Black	263.99 pr.



Velcro® Net Fasteners

Easy on and off with Velcro®!
Attaches net to any goal post up to 4". Pack of 12.
50023 **\$18.99 dz.**

Soccer Goal Safety Padding

Meets NFHS padding rules.
Fits 2" x 4", 4" x 4" square and 3" and 4" round posts. High density 1" thick foam with vinyl coating. Hook and loop fasteners. White only. Ships by truck.
T50358 **\$345.99 pr.**



Sand Bag Anchors

Ideal where in ground anchoring is not available!
Each bag holds up to 50lbs of dry sand (not included). Heavy duty vinyl case and PVC handle. Zipper closure.
50445 Set of 4 - 22" x 15" **\$74.99 set**

Hook & Loop Closure

Custom cut your own straps.
Roll is 1.5" wide and 75' long. Will fit one pair of official goals.
50359 **\$87.99 roll**



Easy Clips™

Fit securely into Easy Track™ so nets won't slip.
Enough clips for a pair of goals. Works for Jaypro® and Kwik Goal® goals. 100 clips per bag.
⚠️ CHOKING HAZARD (1) - SMALL PARTS. Not for under 3 yrs.*
50360 White... **\$87.99 bag** **50363** Red.... **\$87.99 bag**
50361 Pink **87.99 bag** **50364** Blue..... **87.99 bag**
50362 Black..... **87.99 bag**

* Full CHOKING HAZARD descriptions on page 355.

CATCHERS EQUIPMENT



Rawlings® Players Series Catcher's Set

Designed for ages 9-12.

Features a CoolFlo® 6.5"-7" hockey style catcher's helmet with impact resistant shell and cage with moisture wicking technology for better fit and comfort. The 14" chest protector has dual density foam and a pad system and breaks that provide unrestricted motion. 13" double knee leg guards have a reinforced knee and are lightweight and flexible.

43885.....\$124.99 set



Rawlings® Renegade Catcher's Set

Designed for ages 12-15.

Features a CoolFlo® 6.5"-7" hockey style catcher's helmet with impact resistant shell and cage with moisture wicking technology for better fit and comfort. The 15" chest protector has dual density foam and a flexible design for protection. 14.5" triple knee leg guards have a reinforced knee and an over the shoe elastic strap on the toe flap for improved comfort.

43886.....\$174.99 set



Rawlings® CoolFlo® Batting Helmet

State of the air venting and sleek design!

Unique foam configuration forms to the head for added comfort and protection. Pony tail channel for unisex use. Optional chin strap. Meets NOCSAE® standards. Dual density foam forms to size 6.5"-7.5" size. Black only.

43087 Helmet only.....\$23.99 **SALE \$19.97 ea.**
 43090 Helmet with Face Guard 31.99 ea.
 43100 Chin Straps 33.99 dz.



Rawlings® Renegade® CoolFlo® Catcher's Helmet

High strength, impact resistant cage.

Improved interior padding with Pro Dri Plus™ moisture wicking technology for better fit and comfort. ABS vented plastic shell for impact resistance. Meets NOCSAE® standards. Black only.

43085 Youth- fits 6.5"-7" \$51.99 ea.



Champro® Youth Catchers Sets

Sets for a variety of age groups.

43400 Ages 8-11 Includes: 1/43339, 1/43328 & 1/43335.....\$119.99 set
 43402 Ages 12-15 Includes: 1/43339, 1/43325 & 1/43331129.99 set



Champro® HEL-MAX™ Catchers Helmet

"V" Shaped mask enhances impact deflection. One piece ABS shell with multi density pad system adjusts to provide a snug fit. AIRTECH ventilation system keeps players cool. Youth size 6"-7".

43339.....\$51.99 ea.



Champro® Chest Protectors

Contour fit premium chest protectors. Superior quality and construction; polyurethane foam rib pads, polyester satin front covers, abrasion resistant nylon bindings with full elastic back harness. Includes removable tail pads.

43328 15" Long-Ages 8-11\$34.99 ea.
 43325 16.5" Long-Ages 12-15 34.99 ea.

Champro® Baseball/Softball Leg Guards

Ultimate combination of protection and comfort. New lightweight technology with maximum protection. Constructed of high impact polyethylene, perforated foam with Air-Tech lining, double knee and calf wings.

43331 14.5" long, Ages 12-15, D-Knee, Side Wings\$47.99 pr.
 43333 13.5" long, Ages 10-12, D-Knee, Side Wings 43.99 pr.
 43335 12" long, Ages 6-10, D-Knee..... 37.99 pr.



UMPIRE EQUIPMENT

Umpire Equipment

The basics for baseball or softball umpiring.
 43313 Ball Bag\$4.99 ea.
 43314 Brush3.99 ea.
 43315 4-Wheel Indicator 2.99 ea.





SAFETY BALLS

Easton® Incredi-Ball™ SoftStitch Training Balls

Ideal for indoor training.

Description	Item #	Each	Item #	Dozen
A: 9" Baseball Nylon Cover/Foam Core	10036	\$4.50	43544	\$52.99
B: 11" Softball Nylon Cover/Foam Core	10037	5.75	43545	64.99
C: 12" Softball Nylon Cover/Foam Core	10040	5.99	43546	69.99

Easton® Incredi-Ball™ SoftTouch Training Balls

Reduced weight with traditional feel.

Description	Item #	Each	Item #	Dozen
A: 9" Baseball Nylon Cover/Poly Core	10247	\$ 4.50	43547	\$52.99
B: 11" Softball Nylon Cover/Poly Core	10526	5.50	43548	63.99
C: 12" Softball Nylon Cover/Poly Core	10248	5.75	43549	64.99

Debeer® GymBall®

Extra Soft Leather Cover with a soft inner core.

Description	Item #	Each	Item #	Dozen
A: 12" Softball Leather Cover/Fiber Core	43192	\$11.99	43554	\$139.99
B: 14" Softball Leather Cover/ Fiber Core	43193	14.50	43555	169.99
C: 16" Softball Leather Cover/ Fiber Core	43194	14.99	43556	174.99

Debeer® Clincher Softballs

Cork center. New "Trutech" leather cover. The #1 16" ball in the country.

Description	Item #	Each	Item #	Dozen
D: 12" Clincher Leather Cover/Cork Core	43127	\$9.99	43557	\$114.99
E: 14" Clincher Leather Cover/ Cork Core	43191	14.50	43558	169.99
F: 16" Clincher Leather Cover/ Cork Core	43189	14.99	43559	159.99
G: 16" Clincher Leather Cover/Cork Core	43014	14.99	43560	159.99

Safety Balls

Super safe entry level game ball.

Description	Item #	Each	Item #	Dozen
A: Teeball-9" Synthetic Cover/Foam Rubber Core	43202	\$3.65	43550	\$38.99
B: H.S./L.L. 9" Synthetic Cover/Foam Rubber Core	43485	3.65	43551	38.99
C: Softball-11" Synthetic Cover/Foam Rubber Core	43212	4.75	43552	52.99
D: Softball-12" Synthetic Cover/Foam Rubber Core	43844	4.75	43553	52.99

Dura Fast 40 Balls

The toughest plastic ball on the market! An excellent indoor training ball.

Description	Item #	Dozen
A: White 9" Seamless Ball	16043	\$28.99
B: Yellow 9" Seamless Ball	16044	28.99
C: Orange 9" Seamless Ball	16046	28.99

Pitching Machine Balls

Brand name quality at economical prices.

Description	Item #	Each	Item #	Dozen
A: 9" Baseball Firm Cover: Compare To Jugs Sting Free	43216	\$2.79	43293	\$27.99
B: 12" Softball Firm Cover: Compare To Jugs Sting Free	43218	3.69	43294	39.99
C: 9" Safety Baseball Soft Cover: Compare To Jugs Lite-Flite	43287	1.79	43288	17.99
D: 12" Safety Softball Soft Cover: Compare To Jugs Lite-Flite	43205	1.88	43290	24.99

BASEBALLS

Description	Item #	Each	Item #	3 Dz.
A. Wilson A1010PROSST - NFHSA: Leather Cover/Cork-Wool Core	43375	\$7.49	43376	\$229.99
B. Wilson A1010BHS1SST - NFHS: Leather Cover/Cork-Wool Core	43814	6.49	43377	209.99
C. Rawlings ROLB1 - USSSA: Leather Cover/Cork-Wool Core	43817	3.99	43378	134.99
D. Rawlings RIESA - IESA: Leather Cover/ Cushioned Cork	43848	8.19	43397	254.99
E. Champro CBB-40 - Practice: Leather Cork-Rubber	43816	3.99	43561	129.99

Description	Item #	Each	Item #	3 Dz.
A. Wilson A1075BPL-1 - Pony League: Leather Cover/Cork-Wool Core	43819	4.39	43379	144.99
B. Rawlings RPLB-1 - Pony League: Leather Cover/Cork-Rubber Core	43213	3.99	43392	134.99
C. Rawlings RLLB-1 - Little League: Leather Cover/Cork-Rubber Core	43204	3.99	43393	134.99
D. Wilson A1074BLL-1 - Little League: Leather Cover/Cork-Wool Core	43800	4.39	43394	139.99

SOFTBALLS

Slow Pitch Softballs

Description	Item #	Each	Item #	3 Dz.
A. 12" Dudley 4A-069Y - ASA: Synthetic Cover/Polycore .52/300	43136	\$4.59	43403	\$147.99
B. 11" Dudley 4A-923Y - ASA: Synthetic Cover/Polycore .52/300	43137	4.59	43404	147.99
C. 12" Dudley WC12HCY: Composite Cover/Polycore .52/275	43843	5.39	43454	175.99
D. 12" DeMarini WTASTONEL12YAB - ASA: Leather Cover/Polycore .52/300	43455	5.59	43456	199.99
E. 12" DeMarini WTASTONES12YAB - ASA: Synthetic Cover/ Polycore .52/300	43457	4.99	43458	169.99
F. 12" Dudley 4A-068Y - ASA: Composite Cover/Polycore .52/300	43467	5.39	43468	174.99

Fast Pitch Softballs

Description	Item #	Each	Item #	3 Dz.
A. 12" Wilson WTA9011BSST - NFHS: Leather Cover/Polycore .47/375	43459	\$7.29	43460	\$239.99
B. 12" Dudley 4H-311YSB12L - NFHSA: Leather Cover/Cork Core .47/375	43199	6.99	43461	229.99
C. 12" Dudley 4A-147Y - ASA: Leather Cover/Polycore .47/375	43842	5.99	43462	194.99
D. 12" Champro CSB8 - ASA: Synthetic Cover/ Polycore .47/375	43297	5.80	43463	189.99
E. 11" Dudley 4Y-611 - ASA: Leather Cover/Cork Core .47/375	43132	5.99	43464	194.99
F. 11" Champro CSB7 - ASA: Synthetic Cover/Polycore .47/375	43299	5.80	43465	189.99
G. 12" Rawlings IESA 12Y47L - IESA: Leather Cover/Polycore .47/375	43847	7.99	43466	244.99



Bucket of Baseballs

Item 43018 comes with the Rawlings bucket and 30 leather high school quality practice balls. All other sets come with the yellow bucket and 30 baseballs.

- 43018 Rawlings HS Leather Practice \$149.99 pk.
- 43470 Wilson A1010PROSST NFHSA 254.99 pk.
- 43437 Rawlings RLLB-1 147.99 pk.
- 43438 Wilson A1075BPL-1 158.99 pk.

BuyPacks and save!



Bucket of Softballs

Yellow bucket with lid and 18 softballs.

- 43440 Dudley 4A-069Y 12" SP \$89.99 pk.
- 43474 DeMarini WTASTONES12YAB 12" SP 109.99 pk.
- 43445 Dudley 4A-147Y 12" FP 117.99 pk.
- 43469 Wilson WTA9011BSST 12" FP 139.99 pk.

BuyPacks and save!



Ball Bag

Holds up to 36 baseballs or 18 softballs! Constructed with heavyweight vinyl coated nylon, reinforced handles, and heavy duty zipper.
43030 \$13.99 ea.

COMPETITION BATS



Franklin Venom Tee Ball Bat **TEE BALL**
 Pro tack grip, 2.25" barrel. For use with low compression balls only.
 43562 26"/16 oz. \$16.99 ea.



EASTON Alpha-10 **TEE BALL**
 Cushioned grip, alloy construction with 2.75" barrel.
 43123 25"/15 oz. \$24.99 ea.
 43124 26"/16 oz. 24.99 ea.



EASTON Rival Baseball Bat **FAST PITCH**
 Cushioned grip, full rolled over end with 2 1/4" barrel.
 43118 28"/18 oz. \$34.99 ea.
 43119 29"/19 oz. 34.99 ea.
 43120 30"/20 oz. 34.99 ea.
 43121 31"/21 oz. 34.99 ea.



EASTON Hammer **SLOW PITCH**
 Ultra thin 29/32" handle, full rolled over end, evenly balanced 12" barrel.
 43168 32"/25 oz. \$39.99 ea.
 43169 33"/26 oz. 39.99 ea.
 43170 34"/28 oz. 39.99 ea.



EASTON Rebel Softball Bat **SLOW PITCH**
 Cushion rubber grip, 29/32" handle, forged end with loaded end cap, 2 1/4" barrel.
 43158 33"/26 oz. \$59.99 ea.
 43159 34"/28 oz. 59.99 ea.



EASTON Rival Softball Bat **SLOW PITCH**
 Cushioned grip, 29/32" handle, forged end with loaded end cap and 2 1/4" barrel.
 43471 34"/26 oz. \$89.99 ea.
 43250 34"/27 oz. 89.99 ea.
 43256 34"/28 oz. 89.99 ea.



EASTON Pink Sapphire Softball Bat **FAST PITCH**
 29/32" handle with all sports grip, military grade aluminum.
 43045 27"/17 oz. \$29.99 ea.
 43046 28"/18 oz. 29.99 ea.
 43047 29"/19 oz. 29.99 ea.
 43048 30"/20 oz. 29.99 ea.

SAFETY BALLS

Plastic Balls

Plastic safety ball. Limited flight.
 10127 9" Baseball \$1.05 ea.
 10128 12" Softball 1.35 ea.
 10517 12" Softball-yellow 1.39 ea.



10X TOUGHER THAN OTHER PLASTIC BALLS!



Pickle-Ball® Dura Fast 40 Balls

The toughest ball on the market!

Seamless one piece 9" ball that's thicker than traditional plastic balls. Machine drilled hole pattern for excellent flight and bounce. Use indoor or out. Sold in dozen packs.

16043 White \$28.99 dz.
 16044 Yellow 28.99 dz.
 16046 Orange 28.99 dz.



Colored Plastic Balls

Plastic safety ball. Limited flight.

10520 SET OF 6 9" Baseball \$5.85 set
 10530 SET OF 6 12" Softball 6.99 set



PALOS RUFFSKIN™ 90 Set

Ideal for tennis, baseball, softball.



The 3.5" high bounce ball is user friendly for all kinds of activities.

10487 SET OF 6 RUFFSKIN™ 90 Set \$23.99 set

Uncoated Foam Multi-Use Balls

An affordable multi-purpose bouncy foam ball!

An excellent ball for entry level baseball/softball or tennis/paddle games. Assorted colors.

10221 2.75" Assorted colors \$2.89 ea.
 10222 3.5" Assorted colors 3.99 ea.
 10074 2.75" Yellow 1.69 ea.
 10076 3.5" Yellow 2.49 ea.



ZONE PX-4 Balls

High density, soft foam.

The 3.5" bounce free ball is ideal for use with or without a mitt. Textured surface. Great for tossing and catching.

10582 SET OF 6 \$18.99 set

SAFETY BATS



ZONE PX-27 Foam Bottle Bat & Ball Set

Oversized 3 1/2" diameter barrel for greater success!

The ideal beginner bat- durable foam for safety with a ribbed handle for improved grip. Set of six 27" bats and 6 foam 3.5" diameter balls.

24007 SET OF 6 \$59.99 set



ZONE 29" Foam Bottle Bat & Ball Set

Bigger barrel for the next level of hitting!

Lightweight, soft neoprene foam bats are easy to swing. Bats measure 29" L with a 2.75" diameter barrel balls measure 3.5" diameter.

24058 Bats only \$59.99 set

24008 Bats and Balls 74.99 set



ZONE Skinny PX-29 Foam Bat Set

Foam covered hollow plastic bat.

A perfect size, 29" long with a 2" diameter. Set includes 6 bats and 6 balls.

24037 SET OF 6 Bats & Balls \$61.99 SALE \$54.97 set

24038 Assorted Colors, 1 bat and 1 ball 10.50 ea.



Adjustable Foam Bat

Patent pending design adjusts length from 21" to 29"!

A twist of the handle and screw in motion to lock the size in place. Bat is made from pick proof foam with plastic molded handle. Handle lists length sizes for adjusting.

24020 \$14.99 ea.



ZONE Plastic Bat Set

30" Bat is weighted for balance!

Made from tough high density polyethylene with durable plastic grip handles.

24033 SET OF 6 \$24.99 set

24032 Assorted Colors 4.99 ea.



29" Plastic Bat

Lightweight beginner bat to be used with plastic balls.

24054 \$4.99 ea.



30" Plastic Bat

Extra heavy weight plastic bat!

Made from a thick, sturdy plastic with a bottleneck design for a larger sweet spot.

24003 \$5.99 ea.



ZONE Jumbo Plastic Bat Set

Bigger sweet spot allows for greater success!

The 27.5" oversized bat has a big 3.5" diameter perfect for young players!

24052 SET OF 6 \$29.99 set

24050 Assorted Colors 5.99 ea.



ZONE Catch Gloves

For left and right handed players!

These confidence building gloves have hook and loop palms and patches that catch the ball easily for younger players. Gloves are made from flexible neoprene. Includes 6 gloves and 6 soft balls.

16195 SET OF 6 \$64.99 SALE \$49.97 set

GLOVES

**Rawlings®
10.5" Youth Glove**

A perfect fit for smaller hands!
Designed for easy closing with a slanted basket web. Velcro® wrist strap keeps hand in place. Right throw only.



Description	Item #	Each
Rawlings 10.5" Right Throw	43243	\$16.99

**Rawlings®
11" Youth Glove**

An ideal utility glove for all positions.
Leather palm and shell with Neo Flex® back, Basket Web® pocket and Velcro® wrist strap. Ideal beginner glove that's easy to break in.



Description	Item #	Each
Rawlings 11" Right Throw	43864	\$19.99
Rawlings 11" Left Throw	43865	19.99

**Rawlings®
12" Baseball/Softball Gloves**

For infield or outfield positions for baseball or softball!
Versatile leather glove with deep pocket, Basket Web® with angled support strap for shape retention, Neo Flex® back with Velcro® wrist strap for exact fit.



Description	Item #	Each
Rawlings Baseball/Softball 12" Right Throw	43830	\$29.99
Rawlings Baseball/Softball 12" Left Throw	43832	29.99

Rawlings® 13" Baseball/Softball Glove

A great multi-position glove.
The full pattern creates a deep leather pocket with a composite back for strength and durability. Features an overlapping closed Fastback® with Velcro® strap for a custom fit around the wrist and an index finger pad for added protection.



Description	Item #	Each
Rawlings Baseball/Softball 13" Right Throw	43826	\$34.99
Rawlings Baseball/Softball 13" Left Throw	43827	34.99

**Champion Sports
Fielder's Glove**

Designed and made ready to use.
Nylon mesh back and soft synthetic leather front. Adjustable strap with Velcro® closure to fit multiple sizes. Right throw only.



Description	Item #	Each
Champion 10" Right Throw: Youth	43580	\$23.99
Champion 11" Right Throw: Elementary	43581	27.99
Champion 12" Right Throw: Elementary - H.S.	43582	29.99

**Franklin® Field Master®
Midnight Gloves**

Ready to play construction.
Sleek all black color scheme with premium supple synthetic leather construction. Contour fit with adjustable thumb. Right Throw only.



Description	Item #	Each
Franklin 11" Right Throw : Infield	43571	\$17.99
Franklin 12" Right Throw : Infield/Pitcher	43570	20.99
Franklin 13" Right Throw : Outfield	43569	22.49
Franklin 14" Right Throw : Outfield	43579	24.99

**Franklin® Field
Master® Gloves**

A broken in, ready to play glove.
A variety of sizes to fit your needs. The thicker synthetic leather provides a suppleness and durability of true leather for great performance. Basket weave webbing, contour fit.



Description	Right Hand Item #	Each	Left Hand Item #	Each
Franklin 10"	43567	\$17.49	43568	\$17.49
Franklin 11"	43565	17.99	43566	17.99
Franklin 12"	43344	19.99	43342	19.99
Franklin 13"	43345	22.99	43343	22.49

WHICH GLOVE IS RIGHT FOR YOU?



CLASS & TEAM PACKS

Baseball/Softball Glove Packs
12 gloves and a storage bag at a great price!

Buy Packs and save!



Champion Sports Fielder's Glove Pack
43583 11" Black/Tan All RT \$349.99 pk.
43584 12" Black/Tan All RT 369.99 pk.

Rawlings® Glove Packs
43577 11" Youth Glove Pack- 11 RT & 1 LT \$239.99 pk.
43578 12" BB/SB Glove Pack- 11 RT & 1 LT 349.99 pk.



Rawlings® 13" Glove Pack
43882 13" Glove Pack, 11 RT & 1 LT \$399.99 pk.



Franklin Field Master Glove Pack
43346 12" Glove Pack: 11 RT & 1 LT \$239.99 pk.
43347 13" Glove Pack: 11 RT & 1 LT 259.99 pk.



SEE PG. 71 FOR YOUR BUCKET OF BALLS (NOT INCLUDED IN PACKS)



T-Ball Basic Starter Pack
Everything you need to get a game going!
• 1 ea. 43234 Heavy Rubber Batting Tee
• 1 ea. 43123 25"/15 oz. Easton® Beast XT-Ball Bat
• 1 ea. 43124 26"/16 oz. Easton® Beast XT-Ball Bat
• 6 ea. 43202 9" Safe-T-Soft Balls
• 1 set 43233 Lightweight Throw Down Bases
• 1 ea. 36210 Equipment Bag
• 2 ea. 21017 9" Plastic Cone
66427 \$117.99 pk.



Plastic Bat & Ball Starter Pack
Lightweight balls and bottle barrel bats.
Ideal pack for games for all ages. Includes bases, cones, a pitching rubber, bats and balls in 2 sizes. Includes mesh carry bag.
Contents:
• 1 set 43253 Throw Down Bases w/ Pitching Rubber
• 2 sets 10520 9" Colored Plastic Ball Sets
• 2 sets 10530 12" Colored Plastic Ball Sets
• 2 ea. 21017 9" Plastic Cone
• 1 ea. 24003 30" Plastic bat
• 1 ea. 24050 Zone Jumbo Plastic Bat
• 1 ea. 36114 White mesh bag 24 x 36
66430 \$45.99 pk.



Softball Class Pack
Gloves are broken in and ready for play!
The perfect softball equipment pack for junior high and up!
Contents:
• 6 ea. 43192 12" Gym Balls
• 6 ea. 43844 12" Safe-T-Soft Balls
• 12 ea. 43345 13" Softball Gloves RH
• 1 ea. 43343 13" Softball Gloves LH
• 1 ea. 36210 Equipment Bag
43312 \$339.99 pk.



Bow Net® Big Mouth
Our most popular model!
Quick and easy to set up and will handle any age group from t-ball to college. Quickly sets up to a 7' x 7' heavy duty net with fiberglass poles, ground frame and 2 stakes in less than 5 minutes. Weighs 15 lbs. Includes a storage bag.
X43082 \$149.99 ea.

MADE FROM COATED 600 DENIER POLYESTER!



Heavyweight All Purpose Bag
Premium quality coated 600 denier polyester.
Sturdy enough to handle heavier items and made with a heavy material that won't break down. Full zipper closure with full wrap-around handles for additional support. Measures 36"L x 16"W x 16"H. Black only.
36210 \$22.99 SALE \$18.97 ea.

BASES



StayPut® Throw Down Bases
Skid resistant rubber backed carpeted mats!
These bases stay where you put them on any gym or multi-purpose room floor. Soft, nylon carpet is protected by Scotch-Guard® and an anti-microbial treatment to inhibit growth of mildew and mold. Excellent quality. Each base measures 15" x 15". Set includes 1st, 2nd, 3rd base with a home plate and pitcher's square.
43177 \$31.99 set



Batting Stance Trainer
Teach your beginners the proper way to bat!
Made from thick poly vinyl mat is the perfect tool to teach children the correct batting stance. Measures 58"L x 17"W.
43039 \$49.99 ea.



Poly Numbered Bases
Extra heavy oversized rubber training bases.



Large 16"x 16" rugged polyvinyl bases with molded-in numbers. Set includes three non-skid bases and home plate.
43258 \$48.99 set

Colored Throw Down Base Sets
Now available in 6 colors!

Divide fields by colors, use for multiple games in one gym! Thick, premium poly home plate and 3 base sets in vivid colors. Available as a set of 6 base sets- one of each color: red, orange, yellow, green, blue and purple or sold in individual base sets.



43024 Red..... \$24.50 set 43028 Green.... \$24.50 set
43026 Orange..... 24.50 set 43037 Blue 24.50 set
43027 Yellow 24.50 set 43038 Purple 24.50 set
43023 6 Color 6 Base Set- 6 home plates & 18 bases \$ 147.50 **SALE \$132.97 set**

Lightweight Throw Down Bases

Practice rubber bases and home plate.

All rubber throw down bases and home plate. Available in the traditional orange or bright optic yellow.



43233 Orange..... \$10.99 **SALE \$9.97 set**
43001 Yellow..... 13.99 **SALE 10.47 set**

Throw Down Bases w/ Pitching Rubber

Now with a pitching rubber!

All rubber throw down bases, home plate and pitching rubber for an all around play. Use indoors or outdoors. Available in traditional orange.



43253 \$11.99 set

Safe Slide Home Plate

Waffle bottom. Heavy duty white rubber with waffle bottom.

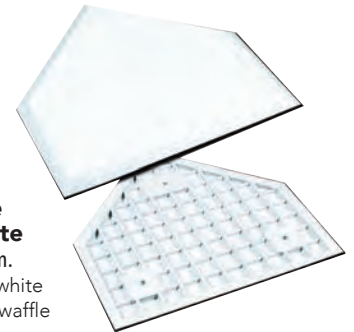

43229 No spikes 1" Thick \$12.99 ea.

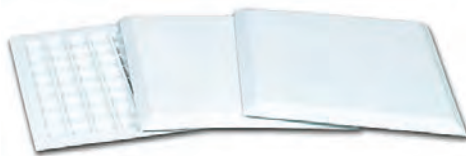

Waffle Bottom Bases
White heavy duty rubber.

Indoor/outdoor. Ribbed underside prevents sliding.
43227 Set of 3 1" Thick \$29.99 set
43241 Set of 3 1/2" Thick 25.89 set

Save-A-Leg Home Plate

Heavy duty rubber. White with black beveled edge. 5 removable spikes.



43230 \$25.99 ea.

Strike Mat

Extension of home plate. Provides an extension of the home plate for use with determining the strike zone in slow pitch softball. 26" L x 17" W. Home plate not included.



43308 \$9.99 ea.

Pro-Style Home Plate
Permanent ground anchor.

After the game it easily slides out of its permanent ground anchor. Heavy rubber construction with steel pan. Official size and shipped complete with ground anchor.

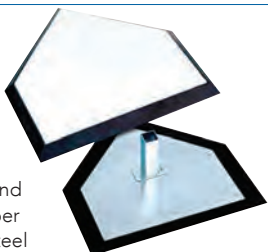

X43003 \$69.99 ea.

Professional Permanent Home Plate
Official size all rubber construction.

Constructed so the plate can be buried for permanent installation. UV resistant rubber.
43000 \$87.99 ea.

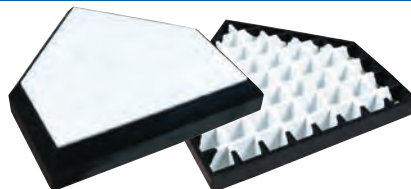

Jab Pitching Plates

Stakes down on the sides! Eliminates stakes ripping through the rubber by having metal supports on the sides. Includes two 8" stakes.



43209 Little League size \$16.99 ea.
43210 Official size 20.99 ea.

BASES

Pro Style Orange Safety Base

When a double first base is required, simply mount this side by side!

Thick, textured, UV rubber top prevents slipping and surface punctures. Inner heavy polyurethane foam padding and reinforced sidewalls to prevent collapse. Nickel plated steel anchor system and sanction pan. Includes 1 base, 1 ground anchor and 1 base plug.

X43017 \$83.99 **SALE \$78.97 ea.**

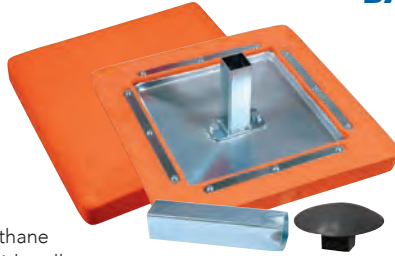

Professional Style Base

All natural rubber cover bonded around condensed foam.

All steel sanction pan and ground anchors. Set of 3 female ground stakes and 3 white bases.

X43221 \$149.99 **SALE \$140.97 set**



Safety Style Base Set

All rubber construction minimizes sliding injuries.

Durable 15" x 15" x 3" soft rubber base with rubber anchors that compress as runner makes contact reducing the possibility of injury. Set of 3 bases plus anchors.

X43021 \$169.99 **SALE \$156.97 set**



SPIKE-DOWN BASE SETS

Base Sets

Your choice of vinyl or heavy canvas.

Vinyl base set has a vinyl coated nylon shell with a firm foam filler. Canvas base set has an extra heavy canvas cover with a rebound fiber core. Both sets come in sets of 3 with 6 base spikes.

X43224 Vinyl Base Set, 15" x 15" x 3" \$49.99 set

X43226 Heavy Canvas Base Set, 15" x 15" x 3" 99.99 set



TOP SELLER

Heavy Rubber Batting Tees
Our number one seller!
Adjustable, durable tee adjusts from 24" to 47". Available in a set of six; one of each color.
X43355 SET OF 6 \$189.99 set

Pro Double First Base

A pro design that compresses at impact.

One piece molded rubber base, simulated quilted top. Complete with 2 posts and anchors. Measure 30" x 15" x 3".

X43304 \$119.99 ea.



Spike Down Double First Base

Prevent collisions at first base!

Use this foam filled, vinyl or canvas covered double first base for additional safety. Complete with 3 straps and spikes.

X43002 Vinyl Base; 30" x 15" x 3" \$33.99 ea.

X43051 Heavy Canvas Base; 30" x 15" x 3" 72.99 ea.

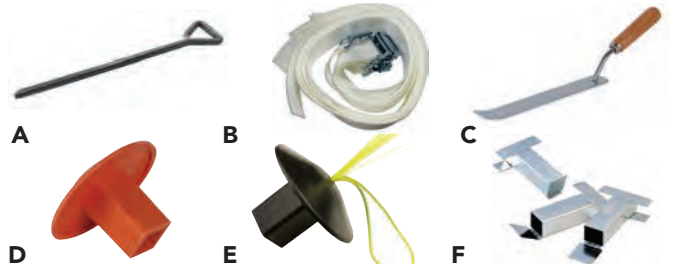

Base Accessories

Spikes and straps are thick and heavy duty. Digout tool is made of tempered steel with a wood handle. Universal fit base plugs indicate position and keep dirt from anchors. Replacement anchors fit most post style base sets.

- A. 43215 Steel Base Spike \$3.25 ea.
- B. 43217 Nylon Base Strap 3.25 ea.
- C. 43025 Steel/Wood Digout Tool 6.99 ea.
- D. 43222 Rubber Base Plug 4.99 ea.
- E. 43260 Deluxe Base Plug w/optic stem 6.99 ea.
- F. 43223 Replacement Female Steel Anchor 7.99 ea.



Heavy Rubber Batting Tee
Number one seller!

Adjustable, durable, all black batting tee. Adjusts from 24" to 47".

X43234 Batting Tee..... \$23.99 ea.

43235 Replacement top 6.99 ea.

18151 Big Bopper Insert..... 16.99 ea.



Portable Batting Tee

Folds down for storage and easy transport!

Adjusts from 24" to 27".

Constructed from hard plastic with a flexible top and weighted bottom for stability.

43279 \$29.99 ea.

HURDLES



SPORTS HEALTH Nexus Hurdles

Adjusts from 6" to 9" to 12" simply by lifting the bar!
Folds flat for storage. Made from molded plastic.

- 16720 Set of 6 Hurdles \$65.99 **SALE \$39.97 set**
- 17200 Set of 6 Hurdles with carry Strap 70.99 **SALE 43.97 set**



SPORTS HEALTH Six Color Training Hurdle Set

Great for defining stations or lanes!

These hurdles are made from sturdy PVC tubing.
Each size available in a set of 6, one of each color.

- 52517 SET OF 6 6" \$39.99 **SALE \$31.97 set**
- 16998 SET OF 6 6" hurdles with carry strap 56.99 **SALE 35.97 set**
- 52518 SET OF 6 12" 49.99 **SALE 39.97 set**
- 16999 SET OF 6 12" hurdles with carry strap 64.99 **SALE 43.97 set**



SPORTS HEALTH Training Hurdles

Change the way you train!

Increase speed, higher knee lift and gain agility skills with these sturdy .75" O.D. PVC hurdles. Orange only.

Description	Item #	Set of 6	SALE	Item #	Set of 6 w/Strap	SALE
A: 6"	42187	\$39.99	\$29.97	16994	\$47.99	\$33.97
B: 12"	42188	49.99	34.97	16995	57.99	38.97
C: 18"	42189	74.99	56.97	16996	82.99	60.97
D: 24"	42190	81.99	61.97	16997	89.99	65.97



Smart Hurdles™

Combine lateral, vertical and forward movement training!

Versatile hurdles for use in agility or over/under training. Each hurdle is constructed from high impact ABS plastic with a sturdy 3 point base and folding support leg for easy storage. All sets include carry handle.

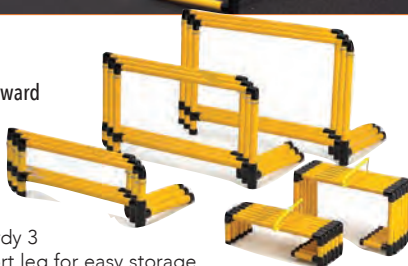

- 42103 Set of 6 6" Hurdles \$99.00 set
- 42104 Set of 6 12" Hurdles 109.00 set
- 42105 Set of 3 12"-18" Adjustable Hurdles 169.00 set
- 42106 Set of 3 21"-36" Adjustable Hurdles 199.00 set
- 42107 Set of 3 27"-42" Adjustable Hurdles 209.00 set



SKLZ Speed Hurdle Pro

Quick adjusting heights for varying training drills.

Hurdles feature a highly durable base, low profile design for feet of all sizes and innovative bounce back construction when stepped on. Adjusts from 6" to 9" to 12" high with one button. Folds for storage. Set of 6 hurdles and carry case.

- 16993 Set of 6 Hurdles with case \$62.99 set



SKLZ 6X Hurdles

Lightweight, durable and featuring bounce back construction.

Use for multi-directional speed, agility and plyometric training. One piece twist design will stand up to the biggest beatings and heaviest of athletes. 6" high, sold in a set of 6 hurdles.

- 16991 Set of 6 Hurdles \$44.99 set
- 16992 Set of 6 Hurdles with Carry Strap 48.99 set



Practice Hurdle

Adjustable to four settings.

Ideal for practice sessions, it adjusts via spring buttons to 30", 33", 36" and 39". Crossbar is 41" long. Frame is made of 1.25" galvanized steel tubing. Call for freight quote. Regular shipping policy does not apply.

- C42023 Single Hurdle \$68.99 ea.
- T66787 3-Pack Hurdles..... 194.99 pk.
- T66788 6-Pack Hurdles..... 389.99 pk.

HURDLES



Gill® Essentials™ Hurdle

Meets official pullover resistance at all heights.

Spring button adjustment to 30", 33", 36", 39" and 42" high. Rigid 41" long double-crossbar. Strong all steel construction. PVC gateboard. 20 lbs. Some assembly required. Call for freight quote. Regular shipping policy does not apply.

- C42116 Single Hurdle \$111.99 ea.
- T66789 3-Pack Hurdles..... 329.99 pk.
- T66790 6-Pack Hurdles..... 599.99 pk.



PowerMax® Versa Hurdle

Collapses on impact!

Simple solution for performing plyometric drills. Adjustable from 12" to 42". Made of 18 gauge tubular steel with a durable gateboard. Zippered mesh bag has handles and shoulder strap, holds up to 10 hurdles. Pack includes 5 hurdles and a bag.

- X42150 Versa-Hurdle \$45.99 ea.
- 42176 Versa-Hurdle Bag..... 25.99 ea.
- X42202 Versa-Hurdle Pack..... 224.99 ea.



ZONE Cone Set

Slotted on top; connecting holes in body!

A multi-purpose cone that allows you to make hurdles or display instruction sheets. 12" plastic cone with 12 holes. Set includes 6 cones in 6 colors and 3 yellow 28" plastic connecting poles.



- 21195 The Zone Cone Kit- 6 cones & 3 poles \$39.90 **SALE \$35.97 kit**
- 21198 SET OF 6 12" The Zone™ -Slotted Cones 31.99 **SALE 25.97 set**
- 17141 28" Yellow Plastic Poles-Set of 3..... 7.99 set



WEIGHTED RUBBER BASE

SlotCones™

The most versatile cone on the market!

Innovative slot design allows any size hoop or crossbar to be locked into the cone. Choose from 12 vertical positions or 5 horizontal (from 3" to 18" high). SlotCones™ are heavier than and twice as strong as a typical cone. Add optional weighted rubber bases for enhanced stability. Lock-In crossbars fit snugly into the horizontal slots. Cones: 18.5"H x 8"W. Crossbars: 40" long.

- 21217 SET OF 6 SlotCones™ \$48.99 set
- 21218 SET OF 6 Lock-In Crossbars 40"L..... 34.99 set
- 21219 Weighted Rubber Base 8.75"L x 8.75"W 7.99 ea.
- 66773 SlotCones Activity Kit - 6 ea. of SlotCones™ & 6 Lock-In Crossbars)..... 79.99 set



Ultimate Cone Crossbar

Adjusts to fit all plastic and vinyl cones!

Adjustable end loops expand and contract to fit any cone top or will rest flat on top of cone. Impact resistant plastic crossbars have a 1" diameter and are 40" long. Sold in sets of six.

- 42182 SET OF 6 \$48.99 set

Over-N-Under™ Training Hurdles

Swings away on contact!

Use multiple height cones for a variety of challenges. Unique anchor point allows for bar to safely swing away when touched by feet or legs. Bars measure 28" long with a 1" diameter. Cones sold separately.

- 42159 SET OF 6 \$79.99 set



SHOT PUTS & DISCUS



Rubber Discus

Solid, one piece construction.

- 42245 **PALOS** 1.0 kilo \$10.99 ea.
- 42038 Gill® 1.0 kilo 20.99 ea.
- 42246 **PALOS** 1.6 kilo 13.99 ea.
- 42039 Gill® 1.6 kilo 21.99 ea.



Gill® Steel Rim Discus

Meets NFHS, NCAA and IAAF specifications!

Smooth flight, great performance and durability! Both models are made with ABS plastic side plates and high quality steel rims.

- 42126 1.0 kilo- H.S. Girls/Jrs-For advanced throwers..... \$89.99 ea.
- 42127 1.6 kilo- H.S. Boys-For advanced throwers..... 86.99 ea.



Gill® Essentials™ Discus

Perfect for novice to intermediate throwers.

The combination of ABS plates and a steel rim gives the discus a 70% rim weight for greater rotation and longer throws. Meets NFHS, NCAA and IAAF specifications.

- 42154 1.0 kilo- H.S. Girls/Middle School - Pink..... \$59.99 ea.
- 42155 1.6 kilo- H.S. Boys - Green 76.99 ea.

Safety Vinyl Discus

Safely practice throwing skills and form.

Made of a flexible polymer, this rubbery disc is air injected so it keeps its shape when thrown. Weighs just under a 1/2 lb. so it's lightweight for elementary ages. Measures 6.25" wide and 1" tall at its highest point. Assorted colors.



- 42063 \$14.99 ea.

TruDisc™ Rubber Throwing Discs

Soft and safe for practice.

These 5.5" diameter discs are made from a firm rubber with a thick vinyl coating. Use for balance activities, tossing, catching or rolling. Sold in a set of 6.



- 13005 **SET OF 6** \$34.99 **SALE \$29.97 set**



Gill® Discus Carrier

Holds 2 discus or 1 discus and 1 shot. Heavy duty vinyl with shoulder strap.

- 42044 \$19.99 ea.

Gill® Shot Put Carrier

Carries 2 shots with room to spare!

Made from top quality, heavy duty vinyl with a handle, shoulder strap and snap top closure.

- 42056 \$19.99 ea.



Iron Shots

Made of cast iron.

Regulation size and weight.

- X42055 4 lb. Special Olympics..... \$31.99 ea.
- X42248 6 lb. **PALOS NEW** 11.99 ea.
- X42249 8 lb. **PALOS NEW** 11.99 ea.
- X42250 4 kilo **PALOS NEW** 11.99 ea.
- X42030 6 lb. Gill® 19.99 ea.
- X42031 8 lb. Gill® 23.99 ea.
- X42032 4 kilo Gill® 27.99 ea.
- X42033 12 lb. Gill® 32.99 ea.
- X42034 16 lb. Gill® 44.99 ea.



Gill® Indoor Softshell Shots

Made of pure polyvinyl plastic.

Filled to exact weights with fine lead shot. Solid red finish. Indoor use only.

- X42025 6 lb. \$78.99 ea.
- X42026 8 lb. 81.99 ea.
- X42027 4 kilo 82.99 ea.
- X42028 12 lb. 91.99 ea.
- X42029 16 lb. 123.99 ea.



Training Shot Put

Lightweight with a soft bounce!

Develop proper shot put form with

these pliable, rubbery PVC covered sand filled shots. Each weighs only 1.3 lbs. which makes them ideal for youngsters and beginners.

- 42146 Blue..... \$10.99 ea.
- 42153 Set of 4- red, yellow, green & blue 38.99 set



Safety Training Disc & Shot Pack

Ideal pack for beginner throwing!

Includes:

- 1 set 13005 TruDisc Rubber Throwing Discs
- 1 set 42153 Training Shot Put Set of 4

- 66716 \$69.99 **SALE \$45.97 pk.**



Gill® Middle School VALUEPACK™

The official middle school track pack.

Pack includes: 2 rubber and 2 Essential™ 1.0 kilo discus, 2 cast iron 4 kilo shot puts and 2 shot/discus carriers.

- X42158 \$257.90 **SALE \$234.97 pk.**

Track Wagon

Ideal for track or other outdoor equipment!

Heavy duty steel mesh deck with powder coat finish with large straight pull handle with padded grip. Folds down with removable sides. Large, 13" pneumatic treaded tires. Measures 34"L x 18"W x 21.75"W with a 400 lb. weight capacity.

- X42175 \$149.99



ACCESSORIES

Coated Foam Relay Batons

Excellent for beginners!
These durable soft coated foam batons are perfect for introducing relays to younger age groups. 10" long with a 1.25" diameter for easy grip.



Available in a set of 6, one of each color.
15062 SET OF 6 \$15.99 set

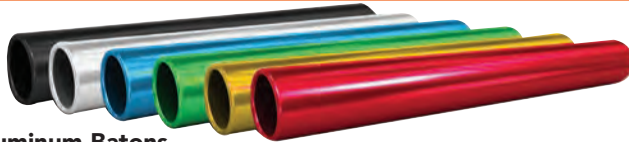

Aluminum Batons

Rounded ends for safety.
Official size, lightweight anodized aluminum.

Black	Silver	Blue	Green	Yellow	Red	Each	SALE
42035	42019	42015	42013	42012	42011	\$3.59	\$2.77



Plastic Baton

Official size, lightweight plastic.

42004 Yellow \$0.99 ea.

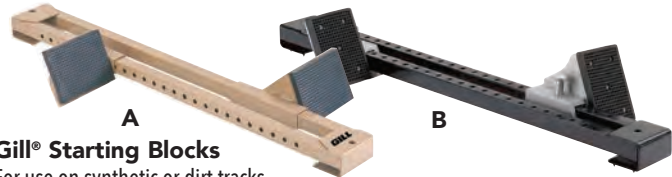

Gill® Starting Blocks

For use on synthetic or dirt tracks.

The Essentials Block "B" is designed with a spring lock pedal adjustment and all steel construction with rubber pedal pads. All Surface Block "A" has a slightly wider rubber faced pedals with 16 gauge steel assembly and snap lock pedal adjustment. Blocks feature built in set spike and includes anchor pins.

42119 A. All Surface Starting Block- 10 lbs. \$109.99 ea.

42120 B. Essentials™ Starting Block- 11 lbs. 86.99 ea.



Deluxe Starters Pistol

Larger size for better feel with blocked barrel and transfer bar for safety.

Five shot, swing out cylinder. Includes hard shell, foam lined case. Uses 209 Primers.

42064 Pistol \$157.99 ea.

42065 Primers-100 per box 8.99 box

Starter Sleeve

Elastic at both ends.

Slides over sleeve to protect clothing from starter pistol residue. Made of water resistant neon-orange nylon.

42108 \$11.99 ea.



Gill® Electronix Starting Device

An alternative to conventional starter pistols.

FinishLynx and Eagle Eye compatible. Connect to a speaker or megaphone to sound (not included). Comes with aux. cable and case. Strobe light tip flashes when device is fired. Uses 3 AA batteries (not included).

42247 \$249.99 ea.

CANOPIES

E-Z UP® Vantage™ Shelter

Reinforced inside and out!

- 10' x 10' with 11'5" peak
- Powder coated steel frame
- Recreational fabric grade
- Includes fabric top, folding frame, roller bag and spike kit
- High strength end caps
- Auto Slider® Pull-Pin
- Toggle leg adjustment
- Reinforced fabric top corners
- Weighs 50 lbs.
- No tools, ropes or loose parts required for assembly.



25. LB Weight Bags

E-Z UP® Pyramid™ Shelter

Spacious head room!

- 10' x 10' with 10'5" peak
- Powder coated steel frame
- Recreational fabric grade
- Includes fabric top, folding frame, roller bag and spike kit
- High strength end caps
- Auto Slider® Pull-Pin
- Toggle leg adjustment
- Reinforced fabric top corners
- Weighs 48 lbs.
- No tools, ropes or loose parts required for assembly.



Sidewalls

Description	Royal	White	Punch	Black	Orange	Steel	Splash	Limeade	Each
E-Z UP® Vantage™ Shelter	25915	25931	25888	25889	25890	25891	25892		\$279.99
E-Z UP® Pyramid™ Shelter	25960	25961		25963	25964	25965	25966	25967	219.99
Sidewalls	25950	25951	25952	25953	25954	25955	25956	25957	39.99
25. LB Wt. Bags-set of 4					25896	25895	25897	25894	49.99

TRAINING JAVELINS



TurboJav

Safe javelin throwing for any age!

The TurboJav is made from polyethylene with a reinforced wall, a special "Y" grip to teach proper grip, a solid tail and soft elastomer nose which will not mar floors. Have fun sharing important lessons on bio mechanics, leverage, center of gravity and motor memory skills of throwing. Colors will vary.

15231 300 gram TurboJav; 27"L Official javelin of the USATF and Jr. Olympics ... **\$37.99 ea.**

15895 400 gram TurboJav; 27"L Official javelin of the USATF and Jr. Olympics **38.99 ea.**

15896 500 gram Long Tom; 42"L Used around the world in many track programs .. **43.99 ea.**



TurboJav Packs

Choose either a 3 or 6 pack of the TurboJav- our most popular styles!

TurboJav 300

66431 3 Pack..... **\$98.99 pk.**

66432 6 pack..... **184.99 pk.**

TurboJav 400

66538 3 Pack..... **\$106.99 pk.**

66539 6 Pack..... **209.99 pk.**



ZONE Foam Rocket Javelin

Weighted for true flight!

A reinforcing tube is inserted in the foam body for extra support and to give additional weight for a smoother flight path. 30" long with a 2" diameter barrel, four 6.5" fins and a 4" soft tip.

15615 **\$8.99 ea.**



NEW

SPORTS HEALTH Station Pack

Everything needed to keep groups moving!

The book provides 6 week sport specific training programs or you can create your own. Items included are the most often used in the book.

Pack includes:

- 2 ea. 13123 SPH Colored Agility Ladder 4 Pk
- 1 ea. 54202 Speed Chute
- 1 ea. 52550 Speed Harness

- 6 ea. 52517 6" Hurdles
- 1 ea. 10126 3" Reaction Ball
- 6 ea. 21048 9" Plastic Cones
- 1 ea. 38090 Speed, Agility and Quickness Book & DVD

66499 **\$189.99 pk.**

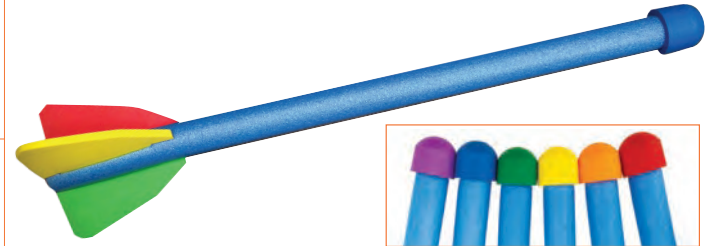

ZONE Bull-Nose Weighted Foam Javelins

Weighted head stabilizes javelin during flight!

Features a reinforced shaft for extra support, three 6.5" fins for better flight and a rubber weighted tip for stability. Can be used indoors or outside. Measures 35"L. Sold in a set of 6.

16198 SET OF 6 **\$74.99 set**



Poly Start and Finish Lines

Perfect for the playground or gym!

Highly visible for safe play! Each line measures 3" x 48" in bright yellow with black raised lettering. Great for using for relays, recess and more!

21143 Starting Line **\$5.99 ea.**

21144 Finish Line **5.99 ea.**



Champion 30 Watt Megaphone

Quality megaphone at a great price!

Features a 1000 yard range, power from 16 to 30 watts and a handheld microphone. Adjustable volume control, powerful siren and shoulder strap. One yr. guarantee. Requires 8C batteries (not included).

47070 **\$89.99 ea.**



Finish Line Tape

Bright red that's easy to see!

A foam 2.75" wide gauze tape, lightweight and easy to break. 30 yard roll.

42152 **\$1.99 roll**



Pennant Streamers

Used for multitude of events.

An inexpensive way to mark fields, direct crowds, attention compeller, cross country meets, etc. Sold in 100' lengths and plastic pennants are 18"L.

42070 **\$9.99 ea.**



Measuring Tapes

Imprinted in both inches and metric scale.

Fiberglass tape resists shrinking, breakage and rusting. Hard plastic casing resists breakage.

42050 100ft/30m Open **\$11.99 ea.**

42046 100ft/30m Closed **9.49 ea.**

Big Yellow 10" Measuring Wheel

5 digit counter reads to 10,000 units!

Measures feet and inches with a magnified lens with an accurate gear driven counter. Adds and subtracts with push reset button. 10" wheel with polyvinyl tread for indoors or out, telescoping handle with pistol grip. Includes kickstand. Overall height is 37.25".

54012 **\$63.99 ea.**



HIGH JUMP

NEW

PORTaPIT® Elementary High Jump Pit

Doesn't require a top pad for hassle-free use during each class.

Created to get the younger athlete involved at an early age, this system is ideal for use in elementary physical education classes and other non-competitive settings. No top pad required. Crossbar/standards not included. Ships by truck.

- T49087 5.5'L x 11'W x 24"H. \$1,999.99 ea.
- T49088 5.5'L x 11'W x 30"H. 2,249.99 ea.



Gill® Jr High & High School High Jump ValuePacks

ValuePacks include mat system, weather cover, standards and crossbar.

Mats are made from heavy duty 18 oz. vinyl coated woven polyester. Seams are folded and triple stitched. One piece design negates the need for a top pad or skirted mesh top! Mats measures 16'L x 8'W x 24"H. Royal blue only. Crossbar is made of fiberglass and measures 13'1" long. Ships by truck.

- 42111 Jr High/HS ValuePack \$4,599.99 SALE \$4,347.97 set
- 42089 Jr High/HS Landing Mat 3,549.99 ea.
- X42090 Jr High/HS School Weather Cover 641.99 ea.
- X42129 High Jump Standards: adjust from 24" to 96" 321.99 pr.



Gill® High School High Jump ValuePack

ValuePack includes mat system, weather cover, standards and crossbar.

Landing Mat measures 16'6"L x 8'W x 26"H and is made from dense polyurethane foam with a soft spot for landings. Heavy duty aluminum standards have a weighted steel base with wheels for easy mobility and adjust from 2' to 7'4". Crossbar is made of fiberglass and measures 13'1" long. Meets high school specifications. Royal blue mat only. Ships by truck.

- 42132 ValuePack \$6,690.99 SALE \$6,389.97 set
- 42133 Scholastic Mat Only 5,599.99 SALE 5,289.97 ea.
- X42134 Weather Cover 836.99 ea.



ZONE Elastic Foam Cross-Bar

Stretches between standards. Bright fluorescent orange cord with 1" diameter foam sections helps simulate the size of the actual bar.

- 42073 \$22.99 SALE \$16.97 ea.

Gill® Essentials Crossbar 3 Pack

Save freight on your bars! One piece pultruded fiberglass with replaceable ends. Meets NFHS specifications. Available for high jump or pole vault. Set of 3. Putter Upper fits over the end of any vaulting pole. Crossbars are not guaranteed against breakage. Inspect crossbars for visible and concealed damage before accepting delivery. 3 packs ship by truck.

- T42162 High Jump- 13' 1.5" (4m) long; 3 pack \$194.99 pk.
- T42163 Pole Vault- 14' 9" (4.52m) long; 3 pack 198.99 pk.
- 42164 Replacement Crossbar End 13.99 ea.
- 42165 Putter Upper Crossbar Placer 20.99 ea.

Gill® 3-Piece Crossbars

Finally a crossbar that can be shipped as efficiently as a small package!

Made from thick walled pultruded fiberglass for minimum sag and excellent durability and with one big benefit- reduced shipping cost! When properly assembled these bars meet NFHS and NCAA rules. Not Guaranteed against breaking.

- X42160 High Jump Crossbar-measures 13' 1.5" (4m) long \$139.99 ea.
- X42161 Pole Vault Crossbar-measures 14' 9" (4.52m) long 143.99 ea.

Ultrak® Watch & Printer Set

Now you can print or download!

The Interface Unit allows you to download from memory or real time on Windows® based computers. Timing functions include: 2000 dual split recallable memory, memory segregated by event, continuous display of event time, dual countdown timers, lap counter and automatic split release. Prints 13 digits per line with a selection of lap and/or cum splits and speed. Interface sold separately.

- 48137 Ultrak® Watch & Printer Set \$349.99 set
- 48138 Windows® Interface Unit 53.99 ea.
- 48139 Printer Paper- 3 rolls per set 24.99 set



Ultrak® 10 Lane Timer

Now with wireless button operation!

Time races with up to 10 lanes and cross country meets with up to 8,000 participants. Linkgate connects the 10 lane buttons to a separate unit and bib numbers can be pre-assigned to lanes in the track mode and entered at the finish for cross country events with an easy edit function. Windows interface so data can be uploaded to a PC or printed out. Includes 4 AA batteries. Prints 13 digits per line.

- 48015 Timer w/ 10 Wired Lane Buttons \$729.99 SALE \$687.97 ea.
- 48096 Timer w/ 10 Wireless Lane Buttons 1,039.99 SALE 987.97 ea.
- 48016 Vinyl Carrying Case for 10 Lane Timer 37.99 ea.
- 48018 Box of 3 rolls of paper 19.99 ea.

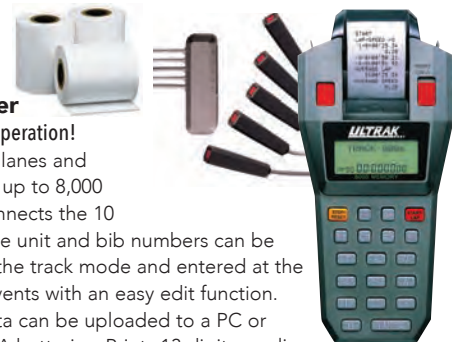

INTRODUCTORY SETS



ZONE Soft Lacrosse Set

A 12 player youth set!

Sticks measure 41.2" long with an aluminum octagonal shaft and a soft, flexible plastic head. Includes 6 red and 6 blue sticks. Softer vinyl ball for safety.

X15239 Set-12 sticks & 6 balls..... **\$109.99 SALE \$99.97 set**

X16006 Replacement Sticks- 1 of each color & 1 ball..... **18.99 pr.**

STX-Ball® Lacrosse Set

The original 12 player set!

Well made 36" stick with aluminum shaft and flexible plastic heads. Designed for long lasting play and durability. Deluxe Game Set includes: 12-sticks, 6 balls, & Brochure.

X15103 Red/Blue Game Set..... **\$159.99 set**

X35311 Green/Yellow Game Set..... **159.99 set**

Replacement Sticks Set of 6 only:

X15104 Sticks Green **X15105** Sticks Yellow..... **\$109.99 set**

X15106 Sticks Red **X15107** Sticks Blue..... **109.99 set**

15108 Orange Ball - Set of 6..... **25.99 set**



Coop® Hydro Lacrosse 12 Stick Pack

Shorter stick allows for greater success!

Sticks measures 16.5"L with a water proof foam handle and plastic head. Use with scooter boards, as an introductory stick, or in the pool! Pack includes 12 sticks in assorted colors and 6 soft, squishy balls.

58233..... **\$99.99 pk.**



Foam Lacrosse Game Set

A complete 12 player set!

Sticks measure 33.5" long with a plastic shaft and an oversized 9" x 12" foam head and large mesh pocket. Soft foam ball for safety.

X15238 Set- 12 sticks & 1 ball..... **\$164.99 set**



Fundamental Lacrosse Pack

Introductory sticks and soft foam balls for safety!

The sticks have an aluminum shaft and soft, flexible head and the balls are a hollow soft vinyl that gives on impact. Pack includes 24 sticks, 12 balls, 2 mini 3' x 3' lacrosse goals and an activity sheet.

Includes:

- 2 sets X15239 Soft Lacrosse Set
- 2 ea. X15919 Mini Lacrosse Goal

X16787..... **\$259.97 pk. SALE \$259.97 pk.**



ZONE 2-N-1 Lacrosse Stick Set

A 12 player dual purpose stick set!

The 36.5" long stick has an aluminum shaft and a soft, flexible plastic head attached to the shaft using a push pin system. Heads come off to play toss games! Includes 6 red and 6 blue sticks. Softer foam ball for safety. Ideal for beginners, youth players or for limited play areas.

X15272 Set- 12 sticks & 6 balls..... **\$189.99 SALE \$159.97 set.**

INTRODUCTORY SETS



4 COLORS AVAILABLE

STX Mini Power Lacrosse Set

A 12 player set!

A 36" stick made with a soft mesh pocket and durable aluminum handle

- X17266 Set- 12 (6 red/white/6 blue) Sticks and 12 balls **\$229.99 set**
- X16784 Set- 12 (6 white/6 green) Sticks and 12 balls **229.99 set**
- X16785 6 Stick Pack- 6 White Power Sticks & 6 balls **115.99 pk.**
- X16786 6 Stick Pack- 6 Green Power Sticks & 6 balls **115.99 pk.**
- X17264 6 Stick Pack- 6 Red Power Sticks & 6 balls **115.99 pk.**
- X17265 6 Stick Pack- 6 Blue Power Sticks & 6 balls **115.99 pk.**



FiddleSTX® Game Sets

Choose 7 or 14 player sets!

These sticks measure 32" long with a plastic handle and mesh pocket. The goalie sticks measure 48" long with a plastic handle and oversized mesh pocket and head. Balls are a softer vinyl for safety. Goals measure 3' x 3' and are made of PVC with a sleeve style slip on netting. 14 Player Set-12 sticks, 2 goalie sticks, 2 goals & 12 balls. 7 Player Set- 6 sticks, 1 goalie stick & 6 balls.

- X15243 14 Player Set **\$214.99 SALE \$197.97 set**
- X15215 7 Player Set **114.99 SALE 99.97 set**

LACROSSE SETS

STX® Mini Eclipse Goalie Stick

Open sidewalls keeps head lightweight.

The 48" miniature stick has an Eclipse head with soft goalie mesh pocket and durable metal handle.

- X17221 **\$26.99 ea.**



STX® Stallion 50™ Lacrosse Set

Entry level competition stick.

Soft mesh pocket makes catching easier with open sidewalls and made from a softer material for a forgiving response. Aluminum alloy shaft is thinner than standard size for younger hands. Overall stick length is 39". Set consists of 12 sticks and 12 soft solid practice balls.

- 16016 Set- 12 sticks & 12 balls. **\$274.97 SALE \$274.97 set**
- 16017 Replacement Stick **24.99 ea.**



STX® Stallion 200 Lacrosse Set

Entry level competition stick.

Wider face with a soft mesh pocket makes catching easier with open sidewalls and a flat scoop to get to the ball faster. Silver aluminum alloy shaft with classic octagon design for easy grip with white head and blue mesh pocket. Overall stick length is 42". Set consists of 12 sticks and 12 official white balls.

- 15817 Set- 12 White sticks & 12 balls **\$499.99 set**
- 17268 Set- 12 Black sticks & 12 balls **499.99 set**
- 15818 White Replacement Stick **39.99 ea.**
- 17267 Black Replacement Stick **39.99 ea.**

MAKES TRANSPORT EASY AND KEEPS THINGS NEAT

Lacrosse Cart

Stores up to

40 lacrosse sticks!

Extra baskets for balls and safety items. Made from impact resistant plastic and easy to assemble.

Cart measures 45.25"L x 19"W x 45"H.

- X36028 **\$284.99 ea.**



GOALS & BALLS

FOLDING GOAL

Folding Steel Lacrosse Goal

An easy storage solution!
Easy on Velcro attached 2.3mm braided polyethylene net with 1 5/8" steel tube construction. Measures 6' x 6'.

X15250 \$127.99 ea.



Steel Lacrosse Goals

Withstands hard shots without breaking!

Constructed from 1 5/8" steel tubing with a powder coat finish. The 2.3mm braided polyethylene net attaches easily with Velcro. Non-folding goals.

X15920 6' x 6' \$109.99 **SALE \$99.97 ea.**

X15922 4' x 4' 79.99 **SALE 69.97 ea.**



STX® Lacrosse Goal

Easy to move and store!

This official size 6' x 6' goal is made from heavy gauge 1.5" steel tubing with orange enamel finish. Includes 2mm official polyester net.

X15259 \$209.99 ea.



Mini Lacrosse Goals

Weighted bottom for stability.

Easy to assemble and breaks down for convenient storage. Goals are made from sturdy 1.5" O.D. PVC tubing with a durable poly/cotton net with nylon sleeves.

X15919 \$49.99 ea.

Champion Lacrosse Pop-Up Target Trainer

Four corner pockets help shooting accuracy!

Made with heavy duty 3/4" mesh netting and nylon binding. Flat steel corners provide stability during drills. Easy flat storage. Includes 4 - 10" ground spikes & carrying bag. Measures 4' X 4'.

18258 \$64.99 ea.



NEW

Rhino Lacrosse Combo Set

An excellent set for beginners to the sport.

Includes all of the body protection necessary to play the game. Featuring shoulder pads, arm guards, gloves, and a chest protector, this lacrosse equipment is designed to keep players safe and provide their upper-bodies with protection. Size small. Ages 5-9.

17358 \$113.99 set

Lacrosse Balls

Game balls are NFHS stamped and NCAA and NOCSAE approved!

15957 White- Official Men's \$23.99 dz.

15958 Yellow- Official Women's... 23.99 dz.

16782 Lime Green- Official Ball ... 24.99 dz.

16783 Royal Blue- Official Ball ... 23.99 dz.



Soft Practice Lacrosse Ball

Excellent for training Soft sponge ball with high bounce. 2.75" diameter.

15729 \$15.99 dz.



STX-Ball Vinyl Ball

High visibility orange!

Great vinyl ball, soft feel, low bounce. 3" diameter.

15108 Set of 6 \$25.99 set



Pink Foam Lacrosse Ball

High density foam pink ball with a high bounce!

Rubberized foam. 2.75" diameter.

16383 \$14.99 dz.



Vinyl Practice Ball Set

Ball weighs only 2.6 oz

Hollow, higher density low bounce ball. 2.75" diameter

16329 Set of 6 \$8.99 set



ZONE Soft Lacrosse Balls

The best, safest training ball on the market!

A soft hollow vinyl that gives on impact, yet allows players to develop their skills.

Plays great, flies true, and fits in the stick's pocket. 2.75" diameter.

16328 Set of 6 \$10.99 **SALE \$8.97 set**

MOST POPULAR



STICK GAMES



Floorball Indoor Winner Series Set
 Concaved, dual sided, blade allows accuracy for both left and right handed players. Heavy duty ABS blades with an innovative design for curved blade performance. Lightweight carbon fiber shafts and premium extra-long rubber grip for enhanced grip and stick handling. Includes: 12 Unihoc Winner sticks, 12 balls, equipment bag, Floorball guide and Floorball curriculum. Choose from 3 sizes.

- X35313 30" Elementary Set..... \$398.99 set
- X35314 34" Middle School Set..... 398.99 set
- X35315 38" High School Set..... 428.99 set



Floorball Outdoor Street Series Set
 Premium ABS blades last longer on outdoor surfaces. New blade design is concaved on both sides for greater accuracy for left and right handed players. Lightweight carbon fiber shafts and premium extra-long rubber grip for enhanced grip and stick handling. Includes: 12 Unihoc Winner sticks, 12 balls, equipment bag, Floorball guide and Floorball curriculum. Choose from 3 sizes.

- X35316 30" Elementary Set \$368.99 set
- X35317 34" Middle School Set 368.99 set
- X35318 38" High School Set 368.99 set



Dom® Field Hockey Set
 The Supersafe Skinex™ covering pads the head of the stick to eliminate fear and reduce injuries. Internal stick structure is designed to maintain a flat hitting surface for player success. Set includes 12-36" sticks, 6 orange and 6 yellow and 6 no bounce plastisol balls.

- X15296 \$196.99 set

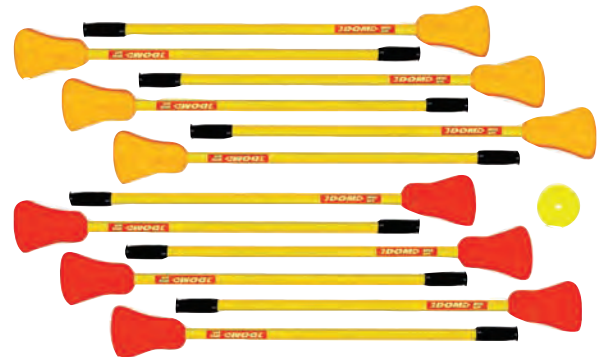

Dom® Broomball Set
 The ultimate floor game!
 Players sweep rather than strike the ball for a more stick controlled game. Made from the same safe design by padding the heads of the sticks with Supersafe Skinex, these 37" sticks are semi-rounded along the bottom for a flat hitting surface. Set includes: 12 sticks- 6 yellow, 6 orange and one 4" low bounce ball.

- X15297 Broomball Set- 12 sticks & 1 ball \$179.99 set

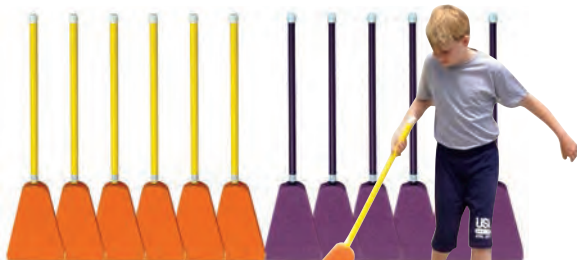

Sof Sweep™ Broomball
 Greater ball control and added safety!
 The over sized 9"W x 12"H Dura-Tuff™ foam heads offer almost twice as much surface area for greater ball handling and are light yet firm and sting free. High impact plastic shafts give a little for safety. Sets includes 12 sticks- 6 orange and 6 purple, one 2" foam ball and one 4" foam puck. 5 YEAR GUARANTEE!

- X35307 36" 12 Player Pack- 12 sticks, 1 ball & 1 puck..... \$119.99 pk.
- X35308 42" 12 Player Pack- 12 sticks, 1 ball & 1 puck..... 129.99 pk.

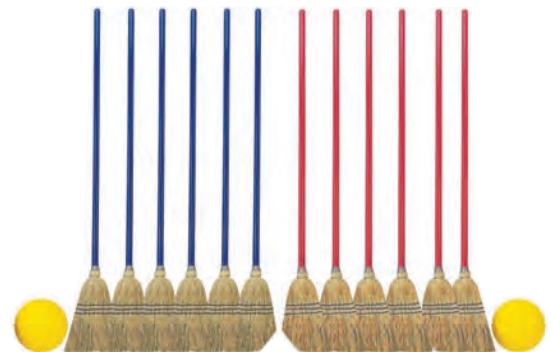

Classic Broomball
 Complete with the classic broom!
 Played by all ages indoors or out. Fast paced, high energy game! Set includes six 48" long red brooms, six 48" long blue brooms, 2 foam 7.5" balls and instructions.

- 15149 Complete Set- 12 sticks, 2 balls & instructions..... \$129.99 set

SHIELD® INDOOR SETS



Lightweight and ideal for youth play!
ABS plastic patented shafts with heavy duty plastic blades that last for years.

Description	Item #	Set
Set of 12: 42" Sticks, 1 Puck & 1 Ball: Ages 10-14	X35102	\$164.99
Set of 14: 12- 42" Sticks, 2 Goalie Sticks, 2 Pucks & 2 Balls: Ages 10-14	X35101	189.99
Extra Sticks: Red 35111 Blue 35115		\$19.99 ea.
Extra Blades: Red 35091 Blue 35095		\$4.49 ea.



Shield® 40" Goalie Sticks

40" sticks available with plastic, wood or aluminum shafts!

X35120 40" Plastic Goalie Stick	\$19.99 ea.
X35100 40" Hardwood Goalie Stick	19.99 ea.
X35208 40" Aluminator Goalie Stick	21.99 ea.



Shield® Hardwood Hockey Sets

Classic hockey stick with a wooden shaft.

Combines quality hardwood shafts with tough, reinforced durable blades.

Description	Item #	Set
Set of 12: 36" Sticks, 1 Puck & 1 Ball: Ages 8-11	X35303	\$132.99
Set of 12: 42" Sticks, 2 Pucks & 2 Balls: Ages 10-14	X35209	144.99
Set of 14: 12- 42" Sticks, 2 Goalie Sticks, 2 Pucks & 2 Balls: Ages 10-14	X35070	181.99
Set of 12: 47" Sticks, 2 Pucks & 2 Balls: Ages 15+	X35204	180.99
Set of 14: 47" Sticks, 2 Goalie Sticks, 2 Pucks & 2 Balls: Ages 15+	X35205	212.99

Extra Blades: Red 35091 Blue 35095 \$4.49 ea.



Shield® Aluminator Stick Set

Convex shaft is easy to grip!

Reinforced plastic blades and lightweight aluminum shaft improves stick handling.

Description	Item #	Set
Set of 12: 36" Sticks, 1 Puck & 1 Ball: Ages 8-11	X35304	\$128.99
Set of 12: 42" Sticks, 2 Pucks & 2 Balls: Ages 10-14	X35075	234.99
Set of 14: 12- 42" Sticks, 2 Goalie Sticks, 2 Pucks & 2 Balls: Ages 10-14	X35068	259.99
Set of 12: 47" Sticks, 2 Pucks & 2 Balls: Ages 15+	X35078	249.99
Set of 14: 2- 47" Sticks, 2 Goalie Sticks, 2 Pucks & 2 Balls: Ages 15+	X35069	274.99



Shield 888 36" Elementary LTG Indoor Set

Made with patented, one piece black ABS plastic shafts and reinforced blades.

Description	Item #	Set
Set of 12: 10- 36" Sticks, 2 Goalie Sticks & 2 Balls: Ages 8-11	X35044	\$115.99
Extra Blades: Red 35082 Blue 35083		\$3.99 ea.

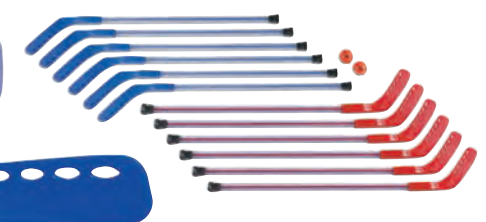

Shield 875 42" Middle School LTG Indoor Set

Made with reinforced plastic and a hollow fiberglass tube with reinforced blades.

Description	Item #	Set
Set of 12: 42" Sticks & 2 Balls: Ages 10-14	X35121	\$244.99
Extra Blades: Red 35091 Blue 35095		\$4.49 ea.



Shield 885 50" High School/Collegiate LTG Indoor Set

Made with black reinforced plastic with a solid fiberglass rod and reinforced blades.

Description	Item #	Set
Set of 12: 10- 50" Sticks, 2 Goalie Sticks & 2 Balls: Ages 15+	X35046	\$132.99
Extra Blades: Red 35091 Blue 35095		\$4.49 ea.

SHIELD® OUTDOOR SETS



IMPORTANT: OUTDOOR INDOOR

Shield Outdoor Blades

Shield Outdoor Blades are thicker than traditional blades and will hold up longer when used on asphalt or concrete. Should not be used indoors-may cause damage to gym floors.



Shield® Plastic Shaft Outdoor Stick Set

Lightweight and ideal for youth play!

Sticks are made with ABS plastic patented shafts with extra thick, reinforced, outdoor plastic blades.

Description	Item #	Set
Set of 12: 36" Sticks & 2 Balls: Ages 8-11	X35160	\$107.99
Set of 12: 42" Sticks & 2 Balls: Ages 10-14	X35161	169.99
Extra Blades: Red 35087 Blue 35088		\$4.99 ea.

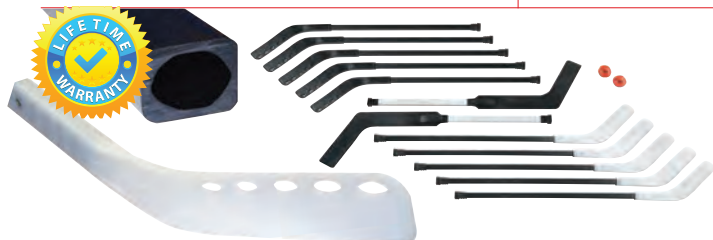

Shield 788 36" Elementary LTG Outdoor Set

Made with patented, one piece black ABS plastic shafts and reinforced blades.

Description	Item #	Set
Set of 12: 10- 36" Sticks, 2 Goalie Sticks & 2 Balls: Ages 8-11	X35045	\$124.99

Extra Blades: Red 35087 Blue 35088 \$4.99 ea.

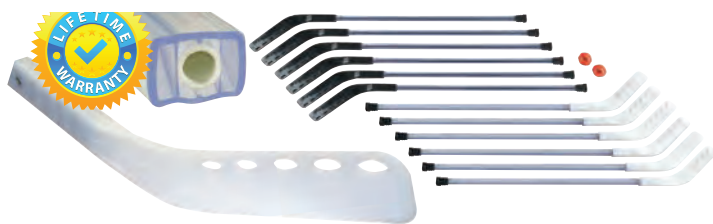

Shield 775 42" Middle School LTG Outdoor Set

Made with reinforced plastic and a hollow fiberglass tube with reinforced blades.

Description	Item #	Set
Set of 12: 42" Sticks & 2 Balls: Ages 10-14	X35132	\$265.99

Extra Blades: Red 35087 Blue 35088 \$4.99 ea.



Shield 785L 50" High School/Collegiate LTG Outdoor Set

Made with reinforced plastic with a solid fiberglass rod and reinforced blades.

Description	Item #	Set
10- 50" Sticks, 2 Goalie Sticks & 2 Balls: Ages 15+	X35047	\$212.99

Extra Blades: Red 35087 Blue 35088 \$4.99 ea.



Shield® Hardwood Outdoor Hockey Set

Classic wood shaft with outdoor blade!

Combines tough hardwood shafts with extra thick, reinforced, durable plastic outdoor blades.

Description	Item #	Set
Set of 12: 36" Sticks & 2 Balls: Ages 8-11	X35305	\$199.99
Set of 12: 42" Sticks & 2 Balls: Ages 10-14	X35092	175.99
Set of 12: 56" Sticks & 2 Balls: Ages 15+	X35134	217.99
Extra Blades: Red 35087 Blue 35088		\$4.99 ea.



Shield® Aluminator Outdoor Hockey Sets

Convex grip improves stick handling!

Reinforced plastic blades for heavy play and durability. Lightweight aluminum shaft is longer with flex for great shooting and control.

Description	Item #	Set
Set of 12: 36" Sticks & 2 Balls: Ages 8-11	X35306	\$121.99
Set of 12: 42" Sticks & 2 Balls: Ages 10-14	X35213	212.99
Set of 12: 47" Sticks & 2 Balls: Ages 15+	X35154	214.99
Set of 12: 53" Sticks & 2 Balls: Ages 15+	X35138	259.99

Extra Blades: Red 35087 Blue 35088 \$4.99 ea.



Cosom® Power Shaft Hockey Sticks

Strong polyethylene shaft with dual I-Beams and wood dowel for support! Blades are made from high density fiberglass and non-marring polyethylene.

Description	Item #	Set
Set of 12: 42" Sticks, 2 Extra Blades, 2 pucks & 2 Balls: Ages 10-14	X35103	\$196.99
Set of 12: 47" Sticks, 2 Extra Blades, 2 pucks & 2 Balls: Ages 15+	X35104	199.99
Set of 12: 52" Sticks, 2 Extra Blades, 2 pucks & 2 Balls: Ages 15+	X35105	206.99

Extra 42" Sticks:	Black 35106	Orange 35107	\$18.99 ea.
Extra 47" Sticks:	Black 35108	Orange 35109	20.99 ea.
Extra 52" Sticks:	Black 35112	Orange 35113	20.99 ea.
Extra Blades:	Black 35122	Orange 35131	5.99 ea.

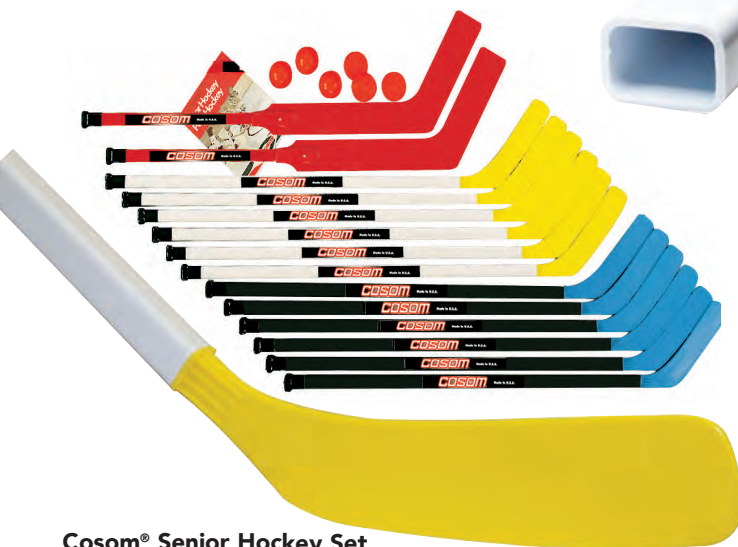

Cosom® Senior Hockey Set

For grades 5 through 12. Sticks are constructed of co-extruded ABS polycarbonate plastic with reinforced fiberglass blades

Description	Item #	Set
Set of 12: 43" Sticks, 2 Extra Blades, 2 pucks & 2 Balls: Ages 10-14	X35128	\$143.99
Set of 14: 12- 43" Sticks, 2 Goalie Sticks, 2 Extra Blades, 2 Pucks & 2 Balls: Ages 15+	X35129	184.99
Set of 14: 12- 47" Sticks, 2 Goalie Sticks, 2 Extra Blades, 2 Pucks & 2 Balls: Ages 15+	X35150	190.99

Extra 43" Sticks:	Blue 35143	Yellow 35144	\$15.99 ea.
Extra 47" Sticks:	Blue 35151	Yellow 35152	16.99 ea.
Extra Blades:	Blue 35145	Yellow 35146	4.99 ea.
Extra Goalie Sticks:	Red 35147	25.99 ea.



Ultra Shaft Hockey Stick Sets

Strong polyethylene shaft with dual I-Beams and wood dowel for support! High density blades with fiberglass reinforcement for strength and stability.

Description	Item #	Set	Sale
Set of 12: 42" Sticks, 2 Extra Blades, 2 pucks & 2 Balls: Ages 10-14	X35201	\$134.99	\$121.97
Set of 12: 47" Sticks, 2 Extra Blades, 2 pucks & 2 Balls: Ages 15+	X35202	144.99	134.97
Set of 12: 52" Sticks, 2 Extra Blades, 2 pucks & 2 Balls: Ages 15+	X35203	151.99	139.97



Rhino® 47" Deluxe Senior Hockey Set

Ideal high school set. Sticks are constructed of strong ABS plastic with high density polyethylene blades.

Description	Item #	Set
Set of 14: 12- 47" Sticks, 2 Goalie Sticks, 2 Extra Blades, 2 Pucks & 2 Balls: Ages 15+	X35254	\$119.99

Extra Blades: Yellow 35257 Blue 35256 \$2.99 ea.



Rhino® 43" Senior Hockey Set

For grades 5 through 12. Constructed of strong ABS plastic shaft with non-marring polyethylene blades.

Description	Item #	Set
Set of 12: 12- 43" Sticks, 2 Extra Blades, 2 Pucks & 2 Balls: Ages 15+	X35255	\$99.99

Extra Blades: Yellow 35257 Blue 35256 \$2.99 ea.



Dom® Replacement Blades

Plastic replacement blades.

For use with Excel, Cup, Pro or Vision sticks.

35182 Red 35183 Blue 35184 Black \$3.69 ea.

For use with Junior or Gain sticks.

35185 Red 35186 Blue \$3.69 ea.

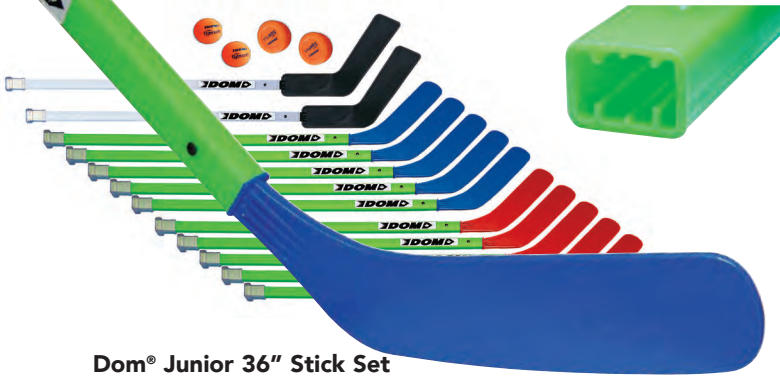

Dom® Junior 36" Stick Set

A lightweight yet sturdy stick for your youngest group!

Built for maximum safety and durability. High density polyethylene shaft with Dom's Superlight insert blade. Twin "I" beam ribs add strength so stick is flexible without breaking or kinking.

Description	Item #	Set
Set of 12: 10-36" Sticks, 2 Goalie Sticks, 2 Pucks & 2 Balls: Ages 8-11	X35116	\$105.99

Extra Sticks: Red 35167 Blue 35166 \$8.99 ea.



Mylec® Jet-Flo® Neon Hockey Stick Set

Neon blades are eye catching!

Lightweight fiberglass blade with a hardwood shaft. Includes 6 of each color.

Description	Item #	Set
Set of 12: 43" Sticks; Six of Each Color: Ages 10-14	X35258	\$114.99
Set of 12: 48" Sticks; Six of Each Color: Ages 15+	X35259	114.99

Extra 43" Sticks: Neon Orange 35260 Neon Yellow 35261 Set of 6 \$61.99 set.
 Extra 48" Sticks: Neon Orange 35262 Neon Yellow 35263 Set of 6 61.99 set.



Dom® Vision Floor Hockey Sticks Set

Blades are easy on gym floors and each stick is double stapled for safety! Shafts are stiffer than polyethylene ones, with twin I-beam rib structure with fiberglass reinforcement. Combination gives you better handling and shooting capabilities.

Description	Item #	Set
Set of 12: 45" Sticks, 2 Extra Blades, 2 Pucks & 2 Balls: Ages 15+	X35008	\$192.99
Set of 12: 52" Sticks, 2 Extra Blades, 2 Pucks & 2 Balls: Ages 15+	X35009	209.99



Dom® Excel 45" Stick Set

An outstanding stick for junior high age and up.

High-density polyethylene outer shell withstands impact and its 1/2" fiberglass reinforcement tubing provides strength and rigidity with a slight gain in weight.

Description	Item #	Set
Set of 12: 10-45" Sticks, 2 Goalie Sticks, 2 Pucks & 2 Balls: Ages 15+	X35117	\$159.99

Extra Sticks: Red 35171 Blue 35170 \$14.99 ea.

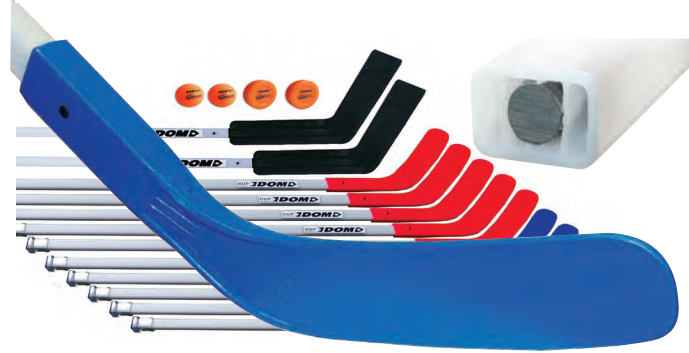

Dom® Cup & Pro Hockey Stick Sets

Includes a double stapled non-slip butt end and impact resistant blade!

High density poly shaft with 1/8" reinforced fiberglass rod, guaranteed not to break!

Description	Item #	Set
Set of 12: 10-47" Sticks, 2 Goalie Sticks, 2 Pucks & 2 Balls: Ages 15+	X35125	\$169.99
Set of 12: 10-52" Sticks, 2 Goalie Sticks, 2 Pucks & 2 Balls: Ages 15+	X35126	179.99

Extra 47" Cup Sticks: Red 35173 Blue 35172 \$16.99 set.
 Extra 52" Pro Sticks: Red 35175 Blue 35174 17.99 set.

CLASS PACKS



Rhino® Ultra Shaft Stick Packs

Available in 12 or 24 player packs in 3 different stick lengths!

High density, fiberglass reinforced blades & polyethylene shafts with wood dowel support. The ZONE POWRPRO 2-in-1 Goal – Reinforced PVC corners, 1.25" steel frame, 2" sq. mesh net, 42"L x 36"H. Pucks and replacement blades. Deluxe hockey cart (pg. 96) sold separately.

- X66450 42" 12 Player Class Pack- 12 sticks, 2 goals, 2 pucks, 2 blades. \$204.99 pk.
- X66451 47" 12 Player Class Pack- 12 sticks, 2 goals, 2 pucks, 2 blades. 214.99 pk.
- X66452 52" 12 Player Class Pack- 12 sticks, 2 goals, 2 pucks, 2 blades. 224.99 pk.
- X66453 42" 24 Player Class Pack- 24 sticks, 4 goals, 4 pucks, 4 blades. 394.99 pk.
- X66454 47" 24 Player Class Pack- 24 sticks, 4 goals, 4 pucks, 4 blades. 415.99 pk.
- X66455 52" 24 Player Class Pack- 24 sticks, 4 goals, 4 pucks, 4 blades. 454.99 pk.
- X36028 Deluxe Hockey Cart- 45.25"L x 19"W x 45"H. 201.99 ea.

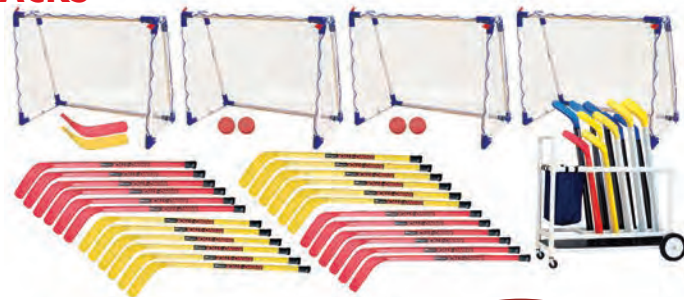

Buy Packs and save!

Rhino® Elementary Class Pack

Choose 12 or 24 packs!

Includes: 36" ABS plastic sticks with polyethylene reinforced blades. The ZONE POWRPRO 2-in-1 Goal – Reinforced PVC corners, 1.25" steel frame, 2" sq. mesh net, 42"L x 36"H. Pucks and replacement blades. Deluxe hockey cart (pg. 96) sold separately.

- X66448 12 Player Class Pack- 12 sticks, 2 goals, 2 pucks & blades \$159.99 pk.
- X66449 24 Player Class Pack- 24 sticks, 4 goals, 4 pucks & blades 315.99 pk.
- X36028 Deluxe Hockey Cart- 45.25"L x 19"W x 45"H. 201.99 ea.

YOUTH SETS



Shield® 36" Molded Elementary Hockey Set

No more broken shafts or blades with this stick!

Simple, one piece design, ribbed for extra strength and long lasting use.

Description	Item #	Set
Set of 12: 36" Sticks, 1 Puck & 1 Ball: Ages 8-11	X35133	\$105.99

Extra Sticks: Red X35136 Blue X35137 \$10.99 ea.



Rhino® 36" Elementary Hockey Set

Lightweight for younger ages!

Durable ABS plastic sticks with polyethylene reinforced, blades that will not mark the floor. Great balance and easy stick handling.

Description	Item #	Set
Set of 12: 36" Sticks, 2 Pucks & Extra Blades: Ages 8-11	X35135	\$89.99

COURT DIVIDERS



Border Patrol

Extra heavy foam padded panels can convert a parking lot or separate gyms into a floor hockey rink.

Constructed with tear-resistant vinyl over extra dense foam with 1.5" attached straps and reinforced corners. The Jumbo panel for behind the nets measures 10' x 22". Used in conjunction with the 10' x 12" side panels will allow you to make a complete rink or construct behind the goal boards. 4 - 5 week delivery time. Ships by truck.

- T35057 Jumbo Indoor/Outdoor 10'L x 22"H, 18 oz vinyl, wt. 36 lbs. \$499.99 ea.
- T35058 Indoor/Outdoor Section 10'L x 12"H, 18 oz vinyl, wt. 14 lbs. 237.99 ea.
- T35059 Indoor Section 10'L x 12"H, 14 oz vinyl, wt. 8 lbs. 227.99 ea.



Shield® Gorilla Bleacher Barriers

Standard

Gorilla

Sixty percent heavier than standard Shield® barriers.

Thicker plastic with a laminated bottom help them stay in place. Block balls and pucks from traveling under bleachers and more. Collapsible and interlocking. 39"L x 11"W x 10.5"H. Set of 8.

X93246 \$226.99 set



Shield® Standard Bleacher Barriers

Stops pucks and balls from sliding under bleachers.

Use to separate lanes, mark obstacle courses or act as hurdles. Collapsible and interlocking. 39"L x 10.5"H x 11"W. Set of 8.

X35049 \$129.99 set.

SPECIALTY SETS

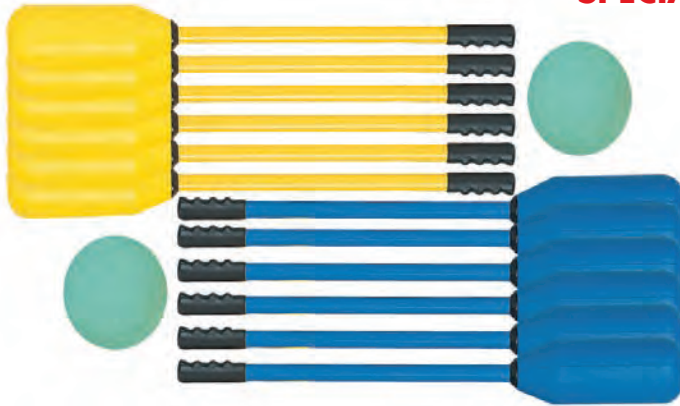

CAN BE USED INDOORS OR OUTDOORS!

ZONE Soft Polo Set

Safe soft foam heads. A fast paced game for 12 players. Perfect for elementary children. Can be played both indoors or outdoors. The 24" long sticks are attached to an extra heavy 6" long foam head.

- X15139 Complete Set- 12 sticks & 2 foam balls.....\$109.99 **SALE \$99.97 set**
- X35189 Double Set- 24 sticks & 4 foam balls.....219.9 **SALE 199.97 set**
- X35190 Replacement Sticks- 1 blue & 1 yellow..... 18.99 pr.



ZONE Softee Hockey

Elementary hockey without the hard plastic blade. This 30" long hockey stick has a soft urethane foam blade and hollow plastic shaft. Complete set comes with 10 sticks, 7" foam ball and 4" ethafoam puck. For indoor or outdoor use.

- X15142 Complete Set- 10 sticks, 1 ball & 1 puck \$99.99 set
- X35196 Double Set- 20 sticks, 2 balls & 2 pucks 197.99 set
- X35197 Replacement Sticks- 1 blue & 1 yellow..... 23.99 pr.



Dom Super Safe Hockey Sticks

Excellent for beginners! The oval shaped shaft provides a great grip, the blade is flexible, yet durable and soft. Constructed of a double "I" beam reinforced polyethylene shaft for superior flex and feel. The blade is a dense covered foam that is virtually indestructible.

- X35191 Complete 30" Set- 10 sticks, 2 pucks & 2 balls \$149.99 set
- X35130 Complete 36" Set- 10 sticks, 2 pucks & 2 balls 159.99 set



Foam Hockey Set

The only foam bladed stick set that combines durability with a softer blade for safety and control. Sticks are made with strong 2" thick ethafoam blades and rounded, flexible plastic shafts that won't kink or break.

- X35123 36" Complete Set- 12 sticks & 2 pucks \$107.99 set
- X35124 42" Complete Set- 12 sticks & 2 pucks 112.99 set



RhinoSkin Soft Polo Set

Lightweight and safe, yet built to last! Made with a sturdy, plastic shaft with a rounded foam head covered with a thick layer of RhinoSkin® to resist wear and tear.

- X15254 Complete Set- 12 sticks & 2 foam balls.....\$269.99 set
- X35194 Double Set- 24 sticks & 4 foam balls..... 499.99 set



RhinoSkin Soft Hockey Set

Oversized heads ideal for younger players! The heavy duty plastic shaft has a great grip and the large blade is made of soft foam with a thick layer of tough RhinoSkin® for durability.

- X15255 Complete Set- 12 sticks, 3 pucks & 3 balls.....\$249.99 set

GOALS



Combo Soccer/Hockey Goal

Use indoors or outdoors.

This deluxe goal is made from 15/8" O.D. ABS rod and is assembled with heavy duty PVC fittings. The 3mm nylon sleeve style netting securely slides over rods for a snug and secure fit. Use for hockey, soccer and more. Measures 4'H x 6'W x 18"D. Includes goal and net.

- X35233 \$154.99 ea.
- 35234 Replacement Net 59.99 ea.



FOLDS FOR EASY STORAGE!

Pro Style Collapse A Goal

Folds down to 5" deep for compact storage.

Fully foldable and collapsible goal is made from 1" diameter high impact ABS plastic with custom fittings for easy folding and all weather sleeve style net. Goal measures 72"W x 42"H x 27"D and includes a back bar for additional support.

- X35231 \$110.99 ea.



All Purpose Folding Goal

The high quality PVC tubing on the frame with center pipe and the extra heavy vinyl sleeving supports the netting.

This alone would make an outstanding goal; add in the easy folding feature for storage and this goal stands above all others. Measures 54"W x 44"H x 24"D.

- X35226 \$52.99 ea.



ZONE POWRPRO Junior Floor Hockey Goals

Perfect pair of goals for small sided games!

Easy-to-move floor hockey goals can be taken outside for soccer as well. Super-fast assembly. Includes 2 PVC goals, 6" soccer ball, hand pump, needle, and 8 ground stakes. Use goals indoors or outside. Measures 30"L x 24"H x 18"D.

- 54286 \$39.99 pr.



ZONE Pop Up Goal

One of the best pop-up goals on the market!

Heavy frame twists and folds to open and close. Heavy reinforced net sleeves with flexible wire retains shape. No assembly required, just twist and you have your goal. Includes carry bag.

- 54199 48"W x 40"H x 37"D. \$59.99 SALE \$49.97 pr.



Pro Style Mini Goal

With pro style top shelf design!

Excellent for no goalie hockey, shooting drills, station activities and more! Portable size of 30.5"W x 23"D with quick assembly. Made from sturdy high impact PVC with sleeve style netting. Includes 2 mini sticks and 1 foam mini ball.

- 50719 \$24.99 set



Bungee Slip-On Net

A floor hockey replacement net.

Simply slip the Bungee net over the frame. Net is made up of durable 32-ply nylon and comes with Velcro® net attachments for the corners of the net for a tighter fit. Net is available in 2 sizes: 72" x 48" x 36" and 48" x 36" x 24", smaller net will expand to fit a 54" x 44" x 24" goal.

- 35222 72" x 48" x 36" \$19.99 ea.
- 35223 48" x 36" x 24" 15.99 ea.

GOALS



STEEL FRAME

ZONE POWRPRO Pro Series 2 in 1 Goal

Excellent practice goal for soccer or floor hockey!

Premium reinforced PVC corners will not blemish gym floors making this goal ideal for outdoors and well as inside. Durable 1.25" diameter steel frame. Includes a braided 2" sq. mesh net with easy-on hooks and 4 metal stakes. Measures 42"L x 36"H x 24"D.

- 54283 \$64.99 ea.
- 66779 Pair of Goals..... 124.99 pr.



STEEL FRAME

SOCCER NET



HOCKEY NET



ZONE POWRPRO Floor Hockey/Soccer Goal

Easily switch sports with a simple change of the 2 included nets.

This versatile goal comes with 2 nets. Use the 4" net for soccer or swap out with the 1.75" net for floor hockey. Premium 1.25" diameter steel frame, reinforced PVC corner joints and twist-tight connectors. Blue twisted nets. Measures 6'L x 51"H x 36"D.

- 54290 \$126.99 ea. **SALE \$99.97 ea.**
- 66780 Pair of Goals..... 253.95 pr. **SALE 198.97 pr.**



Jaypro® Floor Hockey Goal

The most durable indoor/outdoor hockey goal available.

Lightweight 15/16" OD galvanized steel construction with heavy duty non-marring rubber feet to protect floors. Net is sleeved with 14 oz. vinyl with tough, polyethylene 13/4" mesh netting. Goals measure 4'H x 6'W x 20"D and weigh 34 lbs. each.

Description	Item #	Each	Item #	Pair
Blue Goal	35063	\$429.99	35018	\$719.99
Red Goal	35071	429.99	one of each color	
Blue Replacement Net	35064	98.99	35022	69.99
Red Replacement Net	35072	98.99	one of each color	

Mylec® Pro Style Steel Goals

Easy assembly- no tools required!

Made from heavy gauge 1.5" steel tubing with pro style top shelf, back support bar and heavy weight sleeve net system for easy assembly. Solid construction for outdoor play.



- X35217 72"W x 48"H x 33" deep..... \$169.99 ea.
- X35218 54"W x 44"H x 30" deep..... 122.99 ea.
- 35219 Replacement Net pair- for 72"W x 48"H Goal 109.99 pr.
- 35220 Replacement Net pair- for 54"W x 44"H Goal 99.99 pr.



Jaypro® Folding Multi-Purpose Goal

Rolls easy on non-marking wheels and folds flat for storage.

Made with a 1 3/4" O.D. steel frame that includes a durable knotless nylon net with vinyl sleeves and hook and loop closure. Measures 4'H x 6'W. Pair includes one red and one blue net.

- X50366 Pair of Goals..... \$469.99 pr.
- X50367 Red Replacement Net..... 92.99 ea.
- X50368 Blue Replacement Net 101.99 ea.



Shield Target Zone

Installs anywhere there is a basketball rim!

Easily and securely clamps to a basketball rim, made with durable vinyl panels with heavy duty snap fasteners. Targets help improve shooting accuracy and is ideal for all ages and skill levels. The Hockey and Solar Target has 5 scoring zones so there's no goalie needed. It also includes an activity guide full of game ideas. The Target Zone features a 5'H x 4'W scoring zone suitable a variety of activities. Measures 10'H x 5'W and folds for storage. Snap on panels available separately without mounting brackets.

- X16808 Target Zone Hockey Target Complete Unit \$209.99 ea.
- X17275 Target Zone Solar System Complete Unit..... 229.99 ea.
- X16809 Target Zone Complete Unit 209.99 ea.
- X17147 Target Zone Hockey Target only..... 49.99 ea.
- X17148 Target Zone Panel only..... 109.99 ea.
- X17276 Target Zone Solar System Panel Only 109.99 ea.

PUCKS & BALLS



Shield® Bean Bag Puck Set
Innovative new design.
Less vibration, more control and impact absorption due to the unique fill.
39244 SET OF 6 \$23.99 set



Shield Hex Puck
Less vibration and more accuracy!
Glides on gym floors and smooth surfaces 46% faster compared to regular pucks. Soft edge with plastic skid plate for maximum glide.
39241 \$5.59 ea.
66782 Pack of 12 \$31.99 pk.



Pro Puck
Plastic runners help reduce vibration absorb cracks and stay flat!
3" puck glides effortlessly and bounces off curbs adding new dimension to roller hockey. The heavier weight gives the puck a controlled feel, similar to that of ice hockey.
35041 \$8.99 ea.



Shield® Hexagon Hockey Ball
Shape keeps ball on the ground.
Rolls straight and true at a slower speed than vinyl hockey balls.
35310 SET OF 6 \$22.99 set



Plastic Puck
Lightweight hollow puck.
This lightweight, molded plastic puck is ideal for beginners or younger age groups.
35010 \$1.35 ea.
66783 Pack of 12 \$14.99 pk.



Shield Soft Shot Puck
Soft and safe puck!
A perfect weight hollow puck, smooth sliding on gym floors. Soft safe flexible vinyl makes this the most popular.
35011 \$2.99 ea.
66784 Pack of 12 \$31.99 pk.



ZONE Vinyl Puck
Soft, safe and flexible!
Molded rubberized plastic that gives on impact. Great handling on most surfaces.
35187 Vinyl Puck \$1.85 ea.
35269 Pack of 12 \$18.99 pk.



SuperSafe Foam Puck
Contoured edges for reduced drag.
The unique aerodynamics allow for better glide and less flipping.
35013 \$3.79 ea.



Shield® Hotballs
Colorful and low bounce.
Vinyl and one-piece seamless construction these hotballs are smooth rolling and great on all surfaces.
35012 Orange only \$2.99 ea.
35017 SET OF 6 \$16.99 set



ZONE Vinyl Hockey Ball
Low bounce with a great rebound!
Molded rubberized plastic that gives on impact. Great choice for most surfaces.
35188 \$1.85 ea.
35268 12 pack \$18.99 pk.



ZONE PX-4 Balls
High density, soft foam.
Low bounce ball absorbs impact. Multi-surface design.
10582 SET OF 6 \$18.99 set



ZONE Foam Puck Set
Soft and light!
Vinyl coated foam pucks ideal for youth play. Each puck weighs only half an ounce! Traditional size.
35309 SET OF 6 \$8.99 set

NEW

Shield® Felt Puck
Leather wrapped puck moves effortlessly.
Simulates the speed of a Shield Hotball®. Will keep its shape for years.
39245 Single \$5.99 ea.
66781 Pack of 6 \$32.99 pk.



Felt Puck
Layered for smooth play and safety.
This combination felt and durahyde puck feels great on the stick and is soft and safe. Measures 3" in diameter and 3/4" high.
35023 Single \$5.99 ea.
66785 Pack of 6 \$32.99 pk.

TRANSPORT YOUR STICKS, CONES, BALLS & PUCKS THE EASY WAY!

Floor Hockey Carrier
A storage cart and transporter for your floor hockey program.
Cart will hold up to 72 sticks (from 36" to 60" in length), cone compartment for 6" to 18" cones, two baskets for pucks, balls and goggles. Constructed of 1" galvanized steel tubing. 47"H x 30"W x 28"D.
X36144 \$340.99 ea.



Deluxe Hockey Cart
Large detachable bag for pucks and balls!
Made from sturdy, impact resistant PVC tubing with 3" swivel casters in front and 6" all terrain rear wheels. Measures 45.25" L x 19"W x 45"H.
X36028 \$284.99

PROTECTIVE EQUIPMENT



Mylec® Goalie Pack

With or without goalie mask!
Pack includes 27" flexible pads, catch glove for left hand and blocker for right hand. Goalie stick sold separately.

- 66556 Goalie Pack \$164.99 pk.
- 66557 Goalie Pack- with Ultra Pro Goalie Mask 244.99 pk.
- 35036 Ultra Pro Goalie Mask only - ages 12+ 49.99 ea.
- 35053 Goalie Blocker only - 14" x 7" 59.99 ea.
- 35054 Goalie Catch Glove only - ages 13 & under 66.99 ea.
- 35050 Goalie Pads only - 27" 93.99 pr.



Mylec All Purpose Pop Up Goal
Two goals in one!

Target on one side, open net on the other. Twist and fold pop up design, sets up in minutes. Includes carry bag and ground stakes. Measures 54" x 44".

- 35266 \$59.99 ea.

Mylec® Street Hockey Shin Pads

New design features 3/8" foam padding with additional double cushion in the knee. Provides protection from the knees to the instep. Black only, 13" long.

- 35034 \$27.99 pr.



Soccer Shin Guard

Our most popular shin guard. Lightweight design with an outside shell made of a hard plastic and bonded to a comfortable foam backing. Attaches with velcro.

- 50115 8" w/velcro strap \$4.5 pr.
- 50116 7" w/velcro strap 4.25 pr.



Shield Single Density Mouth Guard with Strap

Custom fit in 35 seconds! Comfortable for talking or breathing. One-piece quick release helmet strap. High quality dental vinyl.

- 18000 Clear... \$0.89 ea. 18254 Blue... \$0.79 ea.
- 18253 Black... \$0.79 ea. 18255 Yellow... \$0.79 ea.



Hockey Stick Hand Protector

No more bruised knuckles or fingers! Slides easily up and down the shaft to accommodate each player's grip. Made of a flexi-plastic which glides over shaft as grip position changes during play.

- 35014 \$34.99 dz.



Foam Blade Cover
Softer sticks for safe play!

Tough, durable, semi-soft foam blade covers will prolong the life of the sticks. Simply slip cover over blade. Fits over all standard floor hockey blades. Available in yellow or blue.

- 35215 Yellow \$8.99 ea.
- 35216 Blue 8.99 ea.
- 35267 12 Blade Pack-6 of each yellow and blue.. 99.99 pk.



Multi-Sport Helmet

One of the coolest helmets! Comes with a shock absorbing EPS liner, an ABS impact dispersing outer shell, quick release Nexus buckle and sponge foam adjustment set. Meets the CPSC standards. Available in 3 sizes.

- 13100 Small 21.25"- 22.5" ... \$15.99 SALE \$13.97 ea.
- 13101 Medium 22.5"- 23.25" .. 15.99 SALE 13.97 ea.
- 13102 Large 23.5"- 24.5" 15.99 SALE 13.97 ea.



Helmet with Wire Cage
A completely adjustable helmet.

Features a strong, lightweight helmet with heavy duty wire cage and foam chin cup. Black only.

- 35020 Adult ages 13+ \$52.99 ea.
- 35021 Junior ages 5 to 13 52.99 ea.



Mylec® Pro Goalie Face Mask
PRO model wrap around design with skull plate.

Adjustable straps allow mask to fit kids and adults. Can be painted and personalized.

- Available in white only.
- 35037 \$24.99 ea.



Anti-Fog Goggles

Polycarbonate lens prevents fogging! Made with soft PVC for comfort with an elastic headband for secure fit. Fits over most eyewear.

- 35158 \$3.29 ea.



RipTide™ Eye Guard

Contoured temple arms for snug fit. Ultra light frame for comfort, impact resistant polycarbonate lenses with UV protection.

- 56013 \$3.99 ea.



GreatSpecs®

Superior quality safety goggles! Constructed from shatterproof polycarbonate with anti-fog coating. Flow through ventilation design with an adjustable strap.

- 56017 \$7.99 ea.



Safety Eye Guard Bulk Pack

Polycarbonate lens with UV protection. Comfortable fit with a lightweight, stylish design. Sold in a box of 24 eye guards.

- 56022 \$75.99 box

PALOS

FOAM BALLS FOR EVERY BUDGET AND ACTIVITY!

CHOOSE FROM A VARIETY OF BOUNCE, DENSITY, COLORS, COATINGS AND SIZES.

POWERSKIN™

TUFFSKIN™

RUFFSKIN™



4 YEAR ✓
GUARANTEE

3 YEAR ✓
GUARANTEE

2 YEAR ✓
GUARANTEE

SUPERIOR HEAVY-DUTY VINYL COATING MAKES THIS BALL 50% STRONGER AND "PICK RESISTANT"!

OUR STANDARD, HIGH-QUALITY VINYL COATED FOAM BALL GUARDS AGAINST PEELING OR CRACKING!

DURABLE VINYL COAT AT OUR MOST COMPETITIVE PRICES FOR SCHOOLS ON A TIGHT BUDGET!

PICK THE BOUNCE OPTION THAT'S RIGHT FOR YOU!

▶ **SOFT-LOW BOUNCE**

Our most squishy and non-threatening foam ball.

▶ **MEDIUM BOUNCE**

Great for throwing, catching and target games. Slightly lighter than other foam balls.

▶ **HIGH BOUNCE**

Our most lively foam balls, great for bouncing, dribbling, and rebound games and targets.

SPIDERGRIP™



PALOS SPIDERGRIP™

Fun and cool new spider web-like grip!
The new textured design is applied to the cover of our medium-bounce, high quality Palos TUFFSKIN 3 year guaranteed foam balls. They offer the player a superb grip over traditional coated foam balls. Comes in sets of six colors and 2 different styles.

10580 SET OF 6 Dodgeball 6.3" \$129.99 **SALE \$89.97 set**
10581 SET OF 6 Multi-ball 6.3" \$129.99 **SALE \$89.97 set**

WEB TEXTURE FOR EASY GRIP!



PEWRSKIN™ PREMIUM VINYL COATED COVER

Soft Foam Center • Latex Free • 4 Year Guarantee



PEWRSKIN™ Low-Bounce Softi Sets

Now in 6 colors!

The same thick, triple bonded coated layer for durability and retains the soft, foam feel.

17255 SET OF 6 6.3"	\$79.99 set
17256 SET OF 6 7"	109.99 set
17257 SET OF 6 8.25"	125.99 set



PEWRSKIN™ Multi-Ball Sets

Soft but firm medium-bounce balls!

The same thick, triple bonded coated layer for durability and retains the soft, foam feel.

16157 SET OF 6 6.3"	\$83.99 set
16158 SET OF 6 7"	114.99 set
16159 SET OF 6 8.25"	132.99 set



PEWRSKIN™ High Bounce Foam Ball

High density foam core for extreme bounce!

Use for bouncing, dribbling and rebound games. Super durable coating for long lasting play.

10556 SET OF 6 6.3"	\$119.99 set
10555 SET OF 6 7"	149.99 set
10554 SET OF 6 8.25"	169.99 set



PEWRSKIN™ Dodgeballs

The thickest coated foam ball we've got!

With a triple bonded coated layer for extra toughness, yet the same light weight feel. Each ball measures 6.3". Sold in a set of six.

17269 SET OF 6 6.3"	\$84.99	SALE 74.97 set
---------------------	---------	----------------



PEWRSKIN™ Dodgeballs

The thickest coated foam ball we've got!

With a triple bonded coated layer for extra toughness, yet the same light weight feel. Each ball measures 6.3". Available in red or blue.

10473 6.3" Red	\$13.99 ea.
10894 6.3" Blue	13.99 ea.
66459 6.3" Red 6 Pack	84.99 SALE 74.97 pk.
66774 6.3" Blue 6 Pack	84.99 SALE 74.97 pk.
63100 6.3" 6 Red and 6 Blue-12 Pack	169.9 SALE 148.97 pk.

TUFFSKIN™ PREMIUM VINYL COATED COVER

Soft Foam Center • Latex Free • 3 Year Guarantee



TUFFSKIN™ LOW-BOUNCE Softi

A softer lower bounce ball.

Perfect for many throwing, catching, or kicking games. The low density means less chasing so you can keep playing. Sold in a set of 6.

10407 6.3" SET OF 6	\$64.99 set
17270 7" SET OF 6	95.99 set
17271 8.25" SET OF 6	109.99 set

TUFFSKIN™ Multi-BALL

Soft but firm medium-bounce balls!

A wide variety of activities can be played with this playball, smaller hands can grip and throw with ease. Sold in a set of 6.

10411 4.3" SET OF 6	\$59.99 set
10416 6.3" SET OF 6	69.99 set
10417 7" SET OF 6	96.99 set
10406 8.25" SET OF 6	114.99 set



TUFFSKIN™ Premium Ball Starter Pack

The perfect mix of our Softi and Multi-BALL vinyl coated balls!

Starter Pack includes:

- 1 ea. 10407 6.3" Low-Bounce Softi, Set of 6
- 1 ea. 17270 7" Low-Bounce Softi, Set of 6
- 1 ea. 17271 8.25" Low-Bounce Softi, Set of 6
- 1 ea. 10411 4.3" Multi-BALL, Set of 6
- 1 ea. 10416 6.3" Multi-BALL, Set of 6
- 1 ea. 10417 7" Multi-BALL, Set of 6
- 1 ea. 10406 8.25" Multi-BALL, Set of 6
- 1 ea. 36270 The Zone Duffel Bag
- 66755 \$627.99 pk. **SALE \$598.97 pk.**



PALOS TUFFSKIN™ Footballs

Cover resists peeling and picking!

The most durable coated foam football on the market. Sold in assorted colors or in a set of 6. Size 3, 10".

10490 SET OF 6	\$94.99 set
10408 Assorted Colors	16.99 ea.

PALOS TUFFSKIN™ Soccer Ball

Dense foam soccer ball with TUFFSKIN™ coating.

The most durable foam soccer ball on the market. Size 4.

10439 SET OF 6 7.5"	\$129.99 set
10480 Assorted colors	22.99 ea.

TUFFSKIN™ FOAM BALLS



PALOS TUFFSKIN™ Neon 6.3" Dodgeballs

Same vinyl coating as our TUFFSKIN™ balls!

Low density foam balls for safe play with a heavy duty vinyl cover. Available in six neon colors. Sold in a set of 6. Blue, yellow and green balls glow under blacklight.

- 10433 Neon Green \$64.99 set
- 10434 Neon Pink 64.99 set
- 10409 Neon Orange 64.99 set
- 10436 Neon Yellow 64.99 set



PALOS TUFFSKIN™ Neon 6.3" Dodgeball Set

Bright colors make them perfect for throwing and catching activities!

High quality coated foam balls in bright neon colors. Bright colors help increase visibility. Medium bounce.

- 10507 SET OF 6 \$64.99 set



PALOS TUFFSKIN™ Neon Class Pack

- 66751 Green/Orange Class Pack - 12 balls, 6 of each color \$129.90 pk. **SALE \$124.97 set**



PALOS TUFFSKIN™ Neon Class Pack

- 66752 Yellow/Pink Class Pack - 12 balls, 6 of each color \$129.90 pk. **SALE \$124.97 set**



PALOS TUFFSKIN™ 6.3" Traditional Dodgeball

Softness eliminates the fear of being hurt, available in white or black.

This ball can be squashed down but always bounces back to its original shape. TUFFSKIN™ toughness for durability. Add a variety of team games with the two colors.

- 10405 Black \$11.99 ea.
- 10472 White 11.99 ea.
- 66558 Black 6 Pack- 6 balls 64.99 pk.
- 66559 White 6 Pack- 6 balls 64.99 pk.
- 66403 Black Class Pack- 12 balls & bag 124.99 pk.
- 66456 White Class Pack- 12 balls & bag 124.99 pk.
- 66457 White/Black Class Pack- 12 balls, 6 of each color & bag 124.99 pk.
- 66458 White/Black Jumbo Class Pack- 24 balls, 12 of each color & bag 241.99 pk.



PALOS TUFFSKIN™ 6.3" Dodgeball

Perfect for dodgeball.

Great for a variety of games or just throwing back and forth, smaller hands won't have any trouble gripping this size. Sold in a set of 6.

- 10421 SET OF 6 \$64.99 **SALE \$59.97 set**

RUFFSKIN™ PREMIUM VINYL COATED COVER

Soft Foam Center • Latex Free • 2 Year Guarantee



PALOS RUFFSKIN™ Low-Bounce Softi
 Low impact and low bounce.
 The low density means less chasing so you can keep playing! Sold in a set of 6.

10426 6"	SET OF 6	\$47.99 set
10588 7"	SET OF 6	67.99 set
10589 8.25"	SET OF 6	98.99 set

PALOS RUFFSKIN™ Multi-BALL
 Durable cover resists picking and tearing!
 This medium bounce ball is perfect for beginner soccer drills or toss games. Sold in a set of 6.

10591 6"	SET OF 6	\$46.99 set
10430 7"	SET OF 6	66.99 set
10428 8.25"	SET OF 6	99.99 set

PALOS RUFFSKIN™ 90 High Bounce
 Ideal for tennis, baseball, softball or floor hockey.
 High bounce balls are user friendly for all kinds of activities. Sold in a set of 6.

10485 2.75"	SET OF 6	\$17.99 set
10487 3.5"	SET OF 6	23.99 set



PALOS RUFFSKIN™ Foam Team Handball/Tchoukball Set
 High density foam with thick vinyl cover!
 Great rebound off nets for excellent youth Tchoukball play. Firm foam yet soft enough for a solid grip. Ideal for team handball and other tossing games. 5.75" diameter.

16078	Size 0	SET OF 6	\$59.99 set
10592	Size 1	SET OF 6	66.99 set
10593	Size 2	SET OF 6	74.99 set
16092	Size 0	Assorted Colors	10.99 ea.
10595	Size 1	Assorted Colors	11.99 ea.
10596	Size 2	Assorted Colors	12.99 ea.



PALOS RUFFSKIN™ Foam Ball Starter Pack
 All of our popular RuffSKIN varieties in one convenient package!
 Starter Pack includes:

- 1 set 10426 6" Low-Bounce Softi
- 1 set 10588 7" Low-Bounce Softi
- 1 set 10589 8.25" Low-Bounce Softi
- 1 set 10591 6" Multi-BALL
- 1 set 10430 7" Multi-BALL
- 1 set 10428 8.25" Multi-BALL
- 1 set 10487 3.5" 90 High Bounce
- 1 ea. 36270 The Zone Duffel Bag

66756. \$467.00 pk. **SALE \$396.97 pk.**



RUFFSKIN™ FOAM BALLS



PALOS RUFFSKIN™ Dodgeball Class Pack

Our most popular dodgeball in a two color class pack! Use the two different colors to create different variation of the game requiring cooperation and strategies. Game idea sheet included or visit our website to view games. Each class pack includes mesh storage bags.

10504 6" Black Dodgeball	\$10.50	SALE \$9.47 ea.
10509 6" Grey Dodgeball	10.50	SALE 9.47 ea.
10461 6" Black Dodgeball set of 6	51.99	SALE 46.97 set
10462 6" Grey Dodgeball set of 6	51.99	SALE 46.97 set
66136 Small Pack-12 Dodgeballs (6-black, 6 grey).....	97.99	SALE 89.97 pk.
66137 Large Pack- 24 Dodgeballs (12-black, 12 grey)	193.99	SALE 179.97 pk.



PALOS RUFFSKIN™ Neon Dodgeball Class Packs

Vivid daylight colors that glow under black light! A great alternative ball for Team Dodgeball and more! Activity sheet included with packs or visit our website to view games. Each class pack includes mesh storage bag.

10800 6" Neon Orange Dodgeball	\$10.50 ea.
10801 6" Neon Pink Dodgeball.....	10.50 ea.
10559 6" Neon Orange Dodgeball Set of 6	51.99 pk.
10560 6" Neon Pink Dodgeball Set of 6.....	51.99 pk.
66515 Small Dodgeball Pack- includes 12 Dodgeballs (6 pink & 6 Orange).....	97.99 pk.
66516 Large Dodgeball Pack- includes 24 Dodgeballs (12 pink & 12 Orange).....	193.99 pk.



PALOS RUFFSKIN™ 6" Dodgeball

Soft, safe and economical! For target games, tossing activities and more! Excellent choice when you need low density for safety, yet a durable polyurethane cover for toughness.

10424 SET OF 6	\$54.99	SALE \$44.97 set
----------------------	---------	------------------



PALOS RUFFSKIN™ Soccer Ball

Excellent value ball with a 2 year guarantee! Heavy vinyl, peel resistant coating. It's just as dense- but with a slightly different polyurethane cover from the TUFFSKIN™ balls. Sold in assorted colors or in a set of 6. Size 4.

PALOS RUFFSKIN™ Footballs

Super soft and safe! Great soft feel, enough density in the foam to fly. Sold individually in assorted colors or in a set of 6. Size 3, 10.5" L.

10492.....	\$76.99	SALE \$66.97 set
10493 Assorted Colors.....	12.99 ea.	

10481 SET OF 6 ..	SALE \$71.97 set
10482 Assorted colors.....	14.99 ea.

FOAM ATHLETIC PLAYBALLS



NEW

Thermo Grip Play Balls

Covers change color right in the palm of your hand. Rhino Skin® coating for exceptional tear-resistance. The thermo enhanced covers are activated by body heat. They are sting-resistant, low-density and have a low-bounce foam core and soft exterior. Measures 6.3" in diameter.
 10600 SET OF 6 \$83.99 set



ZONE Foam Easy Grip Balls

Uniquely textured for greater grip!
 A high density, high rebound foam with a near pick proof vinyl coating. Ideal for toss and catch games; not recommended for dodgeball. 5.5" diameter.
 10569 SET OF 6 \$48.99 **SALE \$39.97 set**



RHINOskin™ Swirl 6" Dodgeball Set

Excellent eye tracking!
 Soft low density, 6" diameter balls. These dodgeballs are made of foam with a heavy duty vinyl cover. Use the bright colors for team color assignment or games and activities. Sold in a set of 6.
 10503 SET OF 6 \$79.99 set



RHINOskin™ Metallic 6" Dodgeball Set

Same vinyl coating as our TUFFSKIN™ balls!
 Low density foam balls for safe play with a heavy duty vinyl cover. Set of three: gold, silver and bronze.
 10438 Set of 3 \$43.99 set



PALOS Foam Ball Set

Bright Yellow color helps with tracking!
 High density 2.75" diameter foam with a thick, durable skin coating and molded seams. Available in a set of 6.
 66775 \$9.99 set



Dunlop® SpeedBall

One of the most durable high-bounce foam balls on the market!
 There's just something special about the foam that lets this ball bounce better, keep its shape, not tear or wear out. High density foam, 2 tone for tracking spin and 3.5" diameter
 41020 \$44.99 dz. **SALE \$39.97 dz.**

High Density Medium Bounce Coated Foam Balls

Extra dense foam balls with some body and bounce to it. Vinyl coated for extra durability. Red only.
 10122 4" \$2.99 **SALE \$2.17 ea.** 10124 7" \$8.50 **SALE \$6.97 ea.**
 10123 6" 5.99 **SALE 4.97 ea.** 10125 8.5" 9.99 **SALE 8.97 ea.**

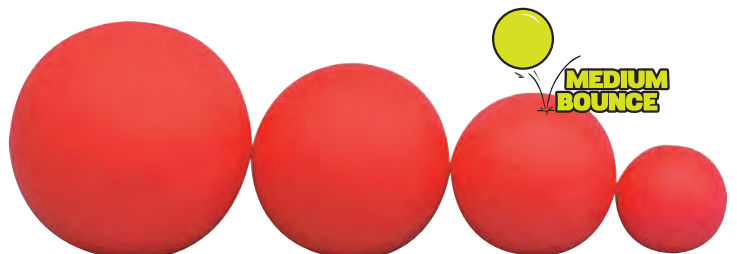

UNCOATED FOAM BALLS



PALOS Ultra-Light Low Bounce Uncoated Foam Balls
Soft, light, molded foam.

Terrific balls for indoor use where softness is important.

- 10585 4" SET OF 6 \$13.99 set
- 10586 6" SET OF 6 18.99 set
- 10587 7" SET OF 6 25.99 set



ZONE PX-4 Bounce Free Balls

Soft, safe and economical!

Specially designed low bounce foam ball. Balls are made from soft, safe foam with high density to last a long time.

- 10582 SET OF 6 \$18.99 set



PALOS Foam Ball Set
Bright, soft and with a heavy density!

These heavy density 8" uncoated foam balls can bring color and fun to your classroom. Sold in a set of 6.

- 10093 SET OF 6 \$49.99 set

PALOS Uncoated Foam Multi-Use Balls

An affordable multi-purpose bouncy foam ball!

Our own version of high bounce tennis balls at an economical price. Available in yellow only.

- 10074 2.75" \$1.69 ea.
- 10076 3.5" 2.49 ea.

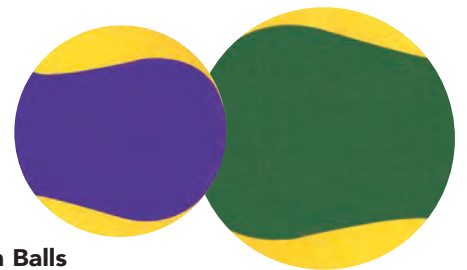

Two-Tone Foam Balls

Multi-toned for easier tracking!

High bounce tennis balls at an economical price. Balls come in assorted multi-toned colors that are easier to track and catch.

- 10221 2.75" \$2.89 ea.
- 10222 3.5" 3.99 ea.



ZONE Super Flings

Use individually, with partners or teams!

Bright colors are easy to see, the 32" nylon tail is easy to catch and the nylon covered soft ball is easy to throw! Ideal for young learners!

- 16103 SET OF 6 \$41.99 set



Tail Ball

A great tossing challenge!

Swing, throw and catch by the 3' tail or the 2.25" ball! The ball has a synthetic cover with a soft filling and is sewn into the multi-colored nylon sock.

- 11056 \$4.99 ea.

FOAM ATHLETIC PLAYBALLS



ZONE Foam Soccer Balls
Great feel, great look!

Nice density 8" foam ball covered with a thick vinyl cover. Sold in a set of 6.

59004 SET OF 6 \$64.99 SALE \$51.97 set



ZONE Foam Football

Two tone for easy eye tracking.

Nicely balanced feel with channels that fit your fingers comfortably. Density is perfect for indoors or outdoors. Ideal 9" long size with a 4.5" diameter for young hands.

29000 SET OF 6 \$44.99 SALE \$36.97 set



Streamer-Ball

Ribbons attached to a 2.25" coated foam ball!

Eye catching and exciting, these streamers can assist with eye tracking and add fun to all sorts of tossing and catching games! Overall length is 16".

10240 \$2.50 ea.



Gripper Multi-Trainer Ball
Ideal ball for many net games!

Combines a soft, tacky feel, grippy textured cover and an oversized 10" diameter to create an outstanding ball.

10995 \$21.99 ea.



Grip Zone V™ Footballs

Excellent all weather ball!

Cover consists of a wrap around textured grip pattern with an alternating grippy vinyl section. Raised laces improve spiral tosses. Butyl bladder.

32333 10.5" Grip Zone V™ - Assorted colors. \$18.99 ea.

32335 8.5" Grip Zone V™ Assorted colors 17.99 ea.



NEW

Grip Zone® Carbon Fiber Balls

Carbon fiber look in a soft, easy to catch design.

Mega grip patented surface makes these balls the easiest to grasp, throw and catch!

Non-threatening and safe for team sports or recreational play. Butyl bladder.

32366 10.5" Football \$17.99 ea.

32367 8.5" Football 16.99 ea.

32368 8" Soccer Ball 17.99 ea.



Gripper™ Balls

The special "Gripper™" mesh is non-slip allowing for sure-grip catches.

The Gripper™ Playballs are constructed with an ultra-light bladder and light nylon hand stitched cover. They are easy to catch, throw and durable enough to kick. Kids will love the wild graphics and texture.

10990 Soccer 10" Oversized \$19.99 ea.

10992 Volleyball Official size 19.99 ea.

10989 Soccer 8" Intermediate Size 18.99 ea.

10994 Basketball 7" \$14.99 ea.

10996 6" Soccer/Handball 13.99 ea.

10995 Multi-Trainer 10" Ball 21.99 ea.

10121 Spot Ball 8.5" \$19.99 ea.

10991 Football 8" Intermediate Size 17.99 ea.

10993 Football 10" Official Size 19.99 ea.

ATHLETIC PLAYBALLS



ZONE BIGFish Footballs
Shaped like footballs!

For indoor or outdoor play, these 28"L x 15"H balls have a soft and safe neoprene cover with machine stitched seams and a beach ball style vinyl bladder that's lightweight yet durable. Set includes 2 sharks and 4 fish.

16093 SET OF 6 \$84.99 **SALE \$69.97 set**



ZONE MiniFish Footballs
Catch, throw and Kick!

Cute and durable Minifish are ideal for water or land! Made from a high quality jerseyne cover with a rubber bladder and inflation valve. Measures 7.5". Set includes assorted fish and sharks.

17154 Set of 5.....\$63.99 set



NEW

The Satryan Ball™ Foam
It's part disc and part ball, but all fun.

Satryan ball can be tossed like a flying disc or kicked and bounced like a ball. Turn it on its side and it bounces. Play Satryan Soccer and more. The foam set is made with a durable polyurethane foam core and cover. Discs measure 8" in diameter.

17412 Satryan Foam SET OF 6 \$86.99 set



Funny Face Balls
Silly graphics to add to the fun!

Great all purpose vinyl ball! Easily inflates, has a sure grip coating for easy catching. 10" diameter. Set of 8 balls.

10449 \$34.99 set



ZONE Tchoukball/Team Hand Ball
Same ball used for Tchoukball.

Lite balls constructed with a synthetic hand stitched tacky cover, an ideal substitute for a soft playing team handball. Colors may vary.

13087 Size 1 \$21.99 **SALE \$15.97 ea.**
13088 Size 2 21.99 **SALE 15.97 ea.**



POWRGRIP Tchoukball

Great grip for easy catching and throwing! Cellular Rubber cover is durable yet soft and cushiony. The Japanese wound bladder provides greater air and shape retention. Multi-panel design with dimpled cover.

17208 Size 1 \$17.99 **SALE \$14.97 ea.**
17209 Size 2 17.99 **SALE 14.97 ea.**

LATEX FREE!



Mikasa® HandBall

Withstands games played against brick walls!

8.5" diameter, premium latex free rubber ball.
10186 \$7.49 ea.

CREATIVE PLAYBALLS



Fluff Balls

The ultimate lightweight fleece ball!

Synthetic fibers have less density than typical fleece balls to slow the movement a little.

- 10524 2.75" Set of 12.....\$7.99 set
- 10525 3.5" Set of 12.....8.99 set



ZONE Pellet Balls

Weighted, Tacky Vinyl balls

These pellet filled tacky vinyl balls are great multipurpose balls. Because of their size and weight, they are great for indoor tossing games where you need a "limited roll" for bocce type games, Juggling, bean bag toss games, and Adapted PE students love the tacky cover and sensory feel from the pellets inside the balls. Size is 2 1/2" diameter.

- 18252 SET OF 6 \$26.99 SALE \$19.97 set



Premium Fleece Balls

Lightweight versatile fleece balls. Soft, durable and safe. Completely washable. Sold in a set of 6.

- 10177 SET OF 6 3" \$14.99 set
- 10178 SET OF 6 4" 19.99 set



Dough Balls

Ideal 2.5" size is great for smaller hands!

Dimpled like a golf ball, super easy to squeeze, yet it still has density making this a really nice, low bounce ball. Not to be used as a golf ball (flight is not good). **⚠ CHOKING HAZARD (3) - CONTAINS A SMALL BALL.** Not for under 3 yrs.*

- 10174 SET OF 6..... \$7.99 set



Fleece Ball Mega Pack

36 balls in a mix of colors and sizes!

You get 18 of the 3" and 18 of the 4" soft fleece balls with a mesh bag for storage.

- 66293..... \$123.99 SALE \$89.97 pk.



Guate Foot Bags

Knitted foot bag.

Slightly larger than the original Hacky Sack, makes it easier to play with. A tightly woven knitted foot bag that is easy to break-in and extremely durable. Great buy!

- 15550.....\$3.99 ea.



Spider Ball

Put on the brakes!

These rubber balls have long rubbery tentacles that make it easier to catch, and provides brakes to quickly stop the ball when rolled.

- 10210 Measures 2.75"\$6.99 ea.



ZONE Tendril Balls

Rubber band-like tentacles cushion on impact.

Silky soft, easy to catch and super safe! A wonderful tactile ball with its eye catching colors, limited bounce and roll. Use for a wide variety of games and activities! Available in two sizes. Set of 6 available in 3.5" size only.

- 10281 Oversize 4.5" Multi-Colored \$4.99 ea.
- 10282 Regular 3.5" Assorted colors 4.99 ea.
- 16142 SET OF 6 Regular 3.5"31.99 SALE \$24.97 set

*Full CHOKING HAZARD descriptions on page 355.

CREATIVE PLAYBALLS



ZONE Grab Ball Set

Flexible vinyl rubber construction makes this ball long lasting and super durable.

Kids can step on this ball and it comes right back to its round shape. Easy to throw, easy to catch, always keeps its shape. Soft and safe. 6" diameter, sold in a set of 6.

17156 SET OF 6 \$45.99 set



ZONE

Tumble-N-Ball

Open design makes it easy to catch and toss!

Unique design and low bounce/low rebound features also makes this an excellent Adaptive PE addition. Made from woven plastic strips covered in soft, foam backed fabric. 7" diameter.

17241 \$13.99 SALE \$9.97 ea.



NEW

ZONE Neoprene 5" Game Ball

Perfect for numerous games and activities.

A combination of soft neoprene and honeycomb textured panels creates superior grip and takes the sting out of hits. The 5" diameter makes this ball excellent for tossing and targeting games. Use as a replacement ball for Sabakiball®. Color: black and red.

17369 \$13.99 ea.

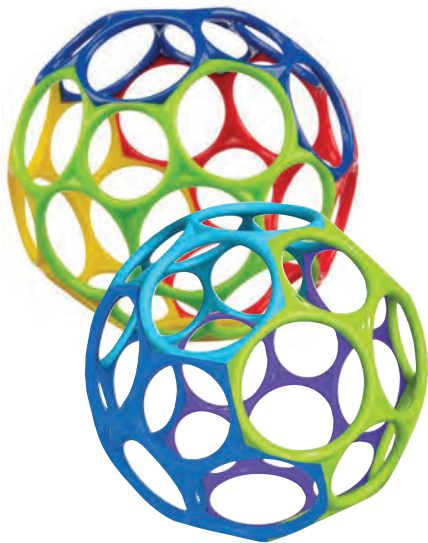

Oball™ Classic

Easy to grip, catch and throw!

Soft, flexible construction with 32 finger holes. 4" diameter. Assorted colors.

16788 \$6.99 ea.



NEW

Edushape Rainbow Soft Ball

Colorful mini-balls rattle inside when tossed.

This 7" clear inflatable ball is filled with miniature plastic balls that bounce around giving visual, auditory and tactile feedback to the thrower and the catcher. Phthalate free. Measures 7" in diameter.

17413 \$9.99 ea.



Fleece Bell Ball

Easy to grip, squeeze, toss and catch.

Brightly colored, soft-to-the-touch ball provides a multitude of sensory and tactile experiences. A great tool for large motor development. Washable. Bell provides added sensory stimulation and auditory tracking, and is safely housed inside a segment of the ball.

17352 6" \$32.00 ea.

17353 13.5" \$52.00 ea.



True Flight Play Ball Set

Soft, friendly, and durable balls for non-intimidating play!

Rhino Skin® foam coated balls are tear resistant, easy to clean and sting-free. Bright colors and an easy to grip hole pattern creates an enhanced visual and tactile experience, excellent for adapted PE programs. A hollow core makes the ball well balanced and provides truer flight. Size 5"D.

17292 SET OF 6 \$49.99 set



True Flight Soccer Ball Set

Soft, friendly, and durable balls for non-intimidating play!

Rhino Skin® foam coated balls are tear resistant, easy to clean and sting-free. Bright colors and an easy to grip hole pattern creates an enhanced visual and tactile experience, excellent for adapted PE programs. A hollow core makes the ball well balanced and provides truer flight. Official size 5.

17290 SET OF 6 \$119.99 set



True Flight Junior Football Set

Unique design helps prevent injuries during play!

Rhino Skin® foam coated balls are tear resistant, easy to clean and sting-free. Unlike traditional footballs, these balls will not hurt if a catch is missed – thanks to the hollow core. Bright colors and an easy to grip hole pattern make them a great addition to adapted PE programs. Junior size 8.5"D.

17291 SET OF 6 \$64.99 set

21"
OVERSIZED!

LATEX FREE!



NEW VALVE

ZONE 21" Grabby™ Ball

New and improved needle valve!

The 21" Grabby™ ball has the same durability and lightweight characteristics as the smaller model, but is easier to track, catch and handle.

16384 Single 21" Blue Ball \$9.99 ea.

PLAYGROUND BALLS



ZONE SupR-Safe Footballs

Lightweight, durable and easy to inflate.

Soft and safe and with a slight tacky feel, this ball is great for indoor or outdoor play. Measures 8.5" L.

32122 SET OF 6 \$48.99 **SALE \$36.97 set**

32104 Mini size (Yellow Only) \$6.99 ea.



LATEX FREE!

ZONE Grabby™ Balls

Inflate from 5" to 9" diameter.

Excellent for throwing, catching, kicking, squeezing, and bouncing. Non-toxic, soft textured PVC foam is as light as a balloon and as strong as a playground ball. New and improved needle valve inflation.

10136 SET OF 6 \$31.99 **Sale \$24.97 set**

NEW VALVE

LATEX FREE!



ZONE Clear Nobbie Football

Grabby™ texture gives it a great feel.

Nobbie design gives it a great grip. Clear look with six colors make this the hottest football out. They're easy to throw and catch, and the nobbie texture promotes play. Inflatable up to 12". Sold in a set of 6.

10135 SET OF 6 \$29.99 **SALE \$22.97 set**

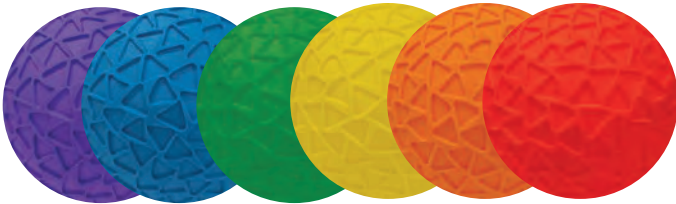

ZONE Easy Grip PX-6

Triangular pattern provides an easy grip for catching and throwing

The material is similar to the Playground Softies or Gertie® balls, yet closer to the weight of a rubber playground ball. Designed with a recessed inflating valve so you can control how bouncy or soft you want the ball.

10502 SET OF 6 3" \$16.99 set

10452 SET OF 6 6" 31.99 set

10270 SET OF 6 8" 33.99 set

LATEX FREE!

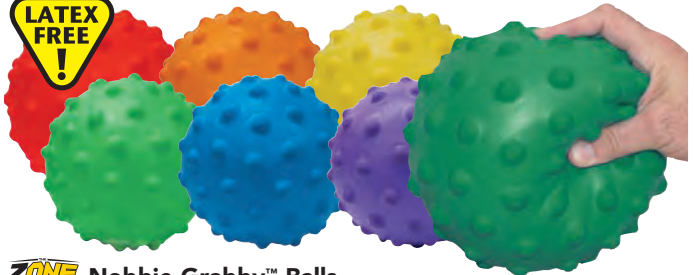

ZONE Nobbie Grabby™ Balls

The neat spongy feel of a Slo-Mo™ ball covered with bumps!

Excellent grip for easy catching. The tactile skin is extremely durable yet thin and lightweight. Inflates from 7" to 10". Sold in a set of 6.

10044 SET OF 6 \$29.99 set



Easy Grip Footballs

Soft touch, great feel!

Foam rubber construction with geometric panels and recessed valve. Soft tips for safety and ease of catching. 9" long. Sold in a set of 6.

10396 SET OF 6 \$42.99 set

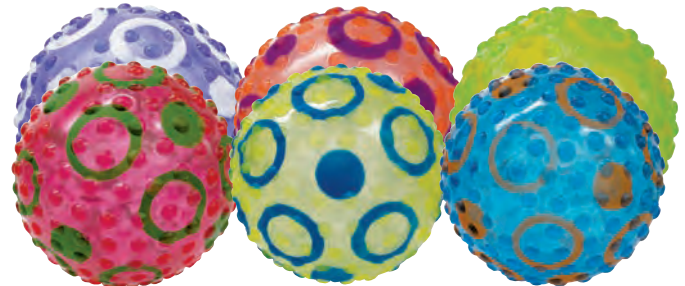

ZONE Bump Balls

A soft, dimpled multi-purpose ball.

Inflatable, soft vinyl ball with molded in bumps is ideal for indoor or outside. Inflates up to 8" dia.

10464 \$25.99 set

PLAYGROUND BALLS



ZONE Softies PGS-8

A cross between a foam and rubber ball!

It's the best of both worlds: soft and safe, yet bouncy and durable for all standard playground ball activities! A similar feel to Grabby™ balls except with thicker walls to last longer. Traditional playground ball stipple for grip and an improved, strong standard ball valve, instead of plug style.

10220 SET OF 6 \$39.99 SALE \$29.97 set



PG Sof's™

The world's softest playground ball!

Blending the best features of playground balls and coated foam balls to create a sting free ball you can squeeze, kick, bounce and more! Easy to throw and great to catch! No internal bladder so you can inflate them less for better squeeze or inflate a little more for a better bounce! Sold in sets of 6.

10261 SET OF 6 6" Playball \$16.99 set
10209 SET OF 6 7" Allround 21.99 set



Voit 4 Square Utility Balls

Nylon wound for increased air and shape retention!

Designed for the game of 4 square or for kicking, striking and hard impact activities. Numbered on one side for added game benefits. Set of 6 balls. Each ball measures 8.5" in diameter.

10546 SET OF 6 \$36.99 set

OUR STRONGEST BALL!



ZONE PX-850 Playground Balls

Weighs and feels like the classic rubber balls- premium quality!

Seamless design through rotational molding of liquid vinyl to prevent shape distortion and loss of air. Great bounce, keeps air and shape.

Textured for easy grip. Measures 8.5" in diameter. Sold in sets of 6.

10357 SET OF 6 \$49.99 SALE \$39.97 set



Rhino® Poly Playground Balls

Ultimate bladderless playground ball!

Made by a special process of rotational molding. Features seamless design, no shape distortion or air leakage even if over inflated Sold in sets of 6.

10354 SET OF 6 4" \$19.99 set 10358 SET OF 6 10" ... \$49.99 set
10355 SET OF 6 6" 29.99 set 10359 SET OF 6 13" 89.99 set
10356 SET OF 6 7" 33.99 set

Rhino® Utility Balls

Made for heavy play!

Constructed of textured, tough rubber with 100% nylon windings and 70% butyl bladder. Yellow only.

10371 8.5" \$9.99 ea.
10372 10" 11.99 ea.



EASY GRIP SURFACE!



Rhino® Four Square Ball Set

Colorful and eye catching!

There's a deep grain on the textured rubber cover for a good grip and ease of catching. Made with nylon windings and a 70% butyl bladder, these 8.5" diameter balls will retain their shape and not lose air. Sold in a set of 4 balls.

10373 \$39.99 set

PLAYGROUND PLAYBALLS



Tachikara® "Kick Ball"

Every class needs a "Kick Ball" for recess. This top grade rubber kickball has a pebbled cover and yarn winding for extra durability. Specially designed for playground use.
10097 \$9.99 ea.



LATEX FREE!

WAKA Kickball
 Official ball of the World Adult Kickball Association!

Premium latex free rubber kickball. Now in two sizes!
10316 8.5" . \$9.99 **SALE \$8.97 ea.**
10002 10" . 11.99 **SALE 10.97 ea.**

7 SIZES TO CHOOSE FROM!



PALOS PX-200™ Playground Balls

Scuff resistant rubber for long lasting play! Easy grip design with 2 ply construction. Air Lock valve for reduced leakage. Red only. Excellent valued priced ball!

- 10083** 5" \$3.79 ea.
- 10085** 6" 4.19 ea.
- 10086** 7" 4.69 ea.
- 10087** 8.5" 4.99 ea.
- 10088** 10" \$5.99 ea.
- 10089** 13" 11.19 ea.
- 10090** 16" 13.49 ea.



WAKA® Kickball Kits

Enough bases and balls to set up two games! Sets includes 4 Official WAKA® kickballs, two sets of rubber bases with pitching rubbers (43253), official WAKA® rules and a durable canvas bottom mesh carry bag (36121).

- 66323** 10" Ball Kit \$85.90 **SALE \$76.97 kit**
- 66566** 8.5" Ball Kit 77.99 **SALE 69.97 kit**

Mikasa Kickball Pack

Everything you need to get a game going! Deluxe 8.5" playground ball that will outlast traditional balls under heavy use. Pack includes a throw down base set with pitching rubber, deluxe 8.5" playground ball that will outlast traditional balls and bag.



- 10032** Mikasa Kickball only \$9.99 set
- 66299** Kickball Pack 20.99 pk.



Voit Enduro CS3 Kickball

Soft but durable rubber cover for all your tough kicking activities! Nylon wound construction provides increased shape and air retention. 8.5" diameter.

- 10547** SET OF 6 \$48.99 set



Rhino® World Kickball Set

Official ball of the World Kickball Association! Premium textured ball with butyl bladder. 10" diameter. The 9 ball set includes one of each ball: red, orange, yellow, green, blue, purple, pink, black and white.

- 10489** \$79.99 set



Rhino® Playground Ball Set

Long lasting, consistent bounce, tons of fun! A good buy as these 8.5" diameter balls will last longer than most rubber playground balls. Made with a tough rubber, textured cover, nylon windings and a 70% butyl bladder. Retains air and shape and offers a true bounce. Sold in a set of 6.

- 10360** SET OF 6 \$55.99 set

PLAYGROUND PLAYBALLS



NEW

Max Numbered Playground Ball Set

Printed numbers and words help improve hand-eye coordination and cognitive learning.

Rhino Skin® coated cover for exceptional tear-resistance. 100% nylon-wound premium textured cover for added grip. 8.5" D (Size 4).

10601 SET OF 6 \$62.99 set



Mikasa® 8.5" Playground Ball Set

Excellent for foursquare or playground use!

Heavy duty ball with deep textured cover provides easy gripping for throwing and catching. Sold in a set of 6.

10055 SET OF 6 \$41.99 set



Tachikara® Playground Balls

Antioxidant agent added to rubber composition for added durability.

Top quality 8.5" rubber balls. Double thickness and four piece construction. One of each color comes in the set of six: red, yellow, purple, green, blue, and orange.

10010 SET OF 6 \$31.99 set

SIZE	RED	ORANGE	YELLOW	GREEN	BLUE	PURPLE	PRICE
8.5"	10016	10013	10021	10012	10015	10014	\$5.50 ea.



Voit® Playground Balls

The playground ball that set the standard.

Classic 2 ply rubber construction with traditional stipple for grip.

Sold in a set of 6.

10367 SET OF 6 6" Size \$29.99 set

10399 SET OF 6 8.5" Size \$34.99 set

10368 SET OF 6 10" Size \$38.99 set



3 YEAR GUARANTEE

PALOS 8.5" PG Extreme™ Playground Balls

Heavy duty nylon wound utility balls.

Get the superior quality and the durability you expect when buying a playground ball. These extra-tough nylon wound balls will withstand the rough play of kicking and playground use. Made with a heavy nylon wounding not used in traditional playground balls for longer wear. Because of its heaviness, appropriate games and drills should be considered. Sold in a set of 6.

10110 SET OF 6 \$46.99 SALE \$39.97 set



PALOS PX-200™ 8.5" Playground Ball Set

Affordable! Scuff resistant rubber for long lasting play!

Easy grip design with 2 ply construction. Air Lock valve for reduced leakage. Sold in a set of 6.

10081 SET OF 6 \$31.99 SALE \$28.97 set

66335 48 Ball Pack- 8 of each color ball & 4 mesh bags ... \$25.90 SALE 229.97 set



Tachikara® Yellow Playground Balls

Hi-visibility, top quality yellow rubber.

Double thickness with an anti-oxidant agent added to rubber composition for added durability. Tachikara® playground balls are resilient, soft, with triple protection against ozone and weathering. ONE YEAR GUARANTEE.

10021 8.5" \$4.49 ea.

10022 10" \$5.99 ea

FOAM ATHLETIC PLAYBALLS



Rhino Soft-Eeze™ Balls

Soft, easy to grip, RhinoSkin tacky covers that are safe for beginners!

These junior size balls are soft, safe and ideal for elementary players first learning skills and techniques. Features a durable RhinoSkin tacky cover with a rubber/butyl bladder good for indoor and outdoor play. The 18 Ball Pack includes one set of each ball- Junior Volleyball, Soccer Ball, Junior Footballs and 2 mesh bags.

- 10374 SET OF 6 Junior Volleyball \$84.99 set
- 10195 SET OF 6 Size 4 Soccer Ball 89.99 set
- 10330 SET OF 6 Junior Footballs 69.99 set
- 66405 18 Ball Pack- 18 balls & 2 mesh bags 252.90 SALE 234.97 pk



ZONE SupR-Safe Ball Sets

Soft inflatable sport balls!

Soft and safe and with a slight tacky feel, this ball is great for indoor or outdoor play. Made from a foamed rubber process that is lightweight, durable and easy to inflate.

- 10066 SET OF 6 6" Soccer Ball \$36.99 SALE \$29.97 set
- 32122 SET OF 6 8.5" Youth Football 48.99 SALE 36.97 set
- 32364 SET OF 6 8.5" Youth Basketball 59.99 SALE 39.97 set
- 66776 18 Ball Pack- 18 balls & 2 mesh bags 153.90 SALE 109.97 pk.



PALOS K-5 Playball Pack

36 soft, safe balls and 2 mesh bags!

- Includes:
- 1 set 10136 Grabby Ball set of 6
 - 1 set 29000 Two Tone Swirl Football set of 6
 - 1 set 10066 The Zone™ SupR-Safe Soccer Balls set of 6
 - 1 set 10220 Playground Softies set of 6
 - 1 set 59004 Two Tone Foam Soccer balls set of 6
 - 2 each 36113 24" x 36" mesh bags

- 66715 \$218.99 SALE \$169.97 set



Fun Gripper™ Colored Ball Set

Unique tacky cover that kids will love.

Constructed with an ultra light bladder, nylon hand-stitched cover and Gripper™ panels. Soccer Ball is 8" in diameter, football is 8" long.

- 10998 SET OF 6 Soccer \$104.99 set
- 10987 SET OF 6 Football 101.99 set



ZONE Weighted Knock Down Targets

Add more fun to any game... the uses are endless.

These 9" targets have a durable, textured foam rubber cover, with a weighted base to prevent easy tipping. Use as station markers or replacements for cones during races. They make exciting alternatives to traditional bowling pins or relay batons. Set them up and then knock them down.

- 17227 SET OF 6 \$38.99 SALE \$27.97 set



INCLUDES 6 MATCHING COLORED BAGS

ZONE Slim Knock Down Pins

Thinner and taller than traditional bowling pins.

Create new configurations to challenge bowlers! Set includes 10 pins of each color with color coded storage bag: red, orange, yellow, green, blue and purple. Made from tough polyethylene with weighted bases. Measures 17" tall.

- 16175 6 color set \$149.99 set



BEACH TYPE BALLS



ZONE 30" Balloon Ball

Bouncy and lightweight!

Twill cloth cover with Velcro® closure.

Includes 1 latex bladder and string tie off.

⚠ CHOKING HAZARD (6) - BALLOON. Not for under 8 yrs.*

10578\$41.99 **SALE \$34.97 ea.**

10579 Replacement Bladder 7.99 ea.

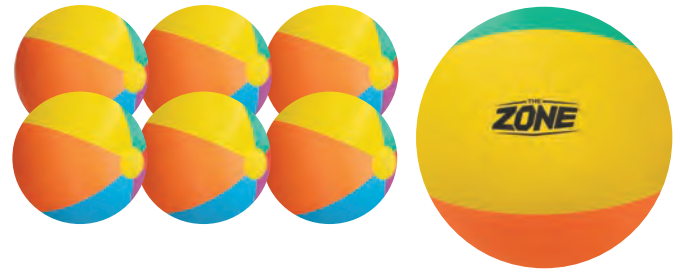

ZONE Heavy Weight Colored Beach Balls

Designed for long lasting use!

Built with thicker vinyl panels and stronger seams than standard beach balls.

10522 18" Set of 6 \$48.99 **SALE \$39.97 set**

10523 24" Set of 6 69.99 **SALE 59.97 set**



Heavyweight Beach Ball

Brightly colored beach balls, not just for the water.

Made of a heavy grade vinyl that will outlast traditional beach balls. This massive ball will provide hours of endless fun. Ideal for Crab Soccer or as a substitute for Cageball activities. Assorted patterns/colors.

10213 24" Diameter\$13.99 ea.

10214 36" Diameter 26.99 ea.



Lightweight Beach Balls

Multi-use lightweight beach balls.

These lightweight vinyl beach balls with an inflatable valve are perfect alternatives for volleyball or soccer balls.

10004 7" dia. \$1.50 ea. 10007 15" dia.\$2.99 ea.

10005 10" dia. 1.99 ea. 10191 23" dia. 6.99 ea.

10006 12" dia. 2.10 ea. 10899 30" dia. 8.99 ea.

35" OVERSIZED!



Jumbo Inflatable Volleyball

Oversized game, set and match fun!

Inflated to 35" in diameter, this vinyl beach ball type ball will score high points with your classes.

33443\$15.99 ea.



Zebra Beach Ball

Exciting Zebra-like stripes will attract attention in any activity.

Made with a durable PVC cover, this ball will outlast traditional beach balls. This brightly striped ball inflates to 20" diameter and weighs 8 oz.

10077 \$5.99 ea.

Balloons

Assorted sizes for a variety of games!

Play games like balloon volleyball, use for relays and fun days! Perfect for teaching eye-hand coordination. Sold in assorted colors. 144 balloons per bag.

⚠ CHOKING HAZARD (6) - BALLOON. Not for under 8 yrs.*

10218 5"\$6.99 bag 10216 9"\$9.99 bag

10217 7" 7.99 bag 10215 11" 17.99 bag



6 FEET TALL

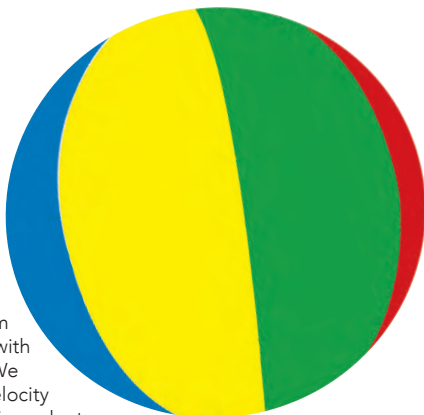

Giant Beach Ball

A humongous 6' ball!

Great for field day, crab soccer, net games and push ball games. Made from heavy duty raft grade vinyl with a large rapid inflate valve. We recommend using a high velocity inflator with oversized inflating adapter.

10529 \$71.99 ea.

Neon Punch Balls

A great coordination enhancer!

Playful punch balls inspire movement and are a great lead up to other games! Inflates up to 10" diameter. Pack of 50.

⚠ CHOKING HAZARD (6) - BALLOON. Not for under 8 yrs.*

10009\$16.99 pk.



Balloon Pump

Dual action inflates balloons quickly!

All plastic design. Lightweight and portable to take anywhere!

44004 \$4.99 ea.

*Full CHOKING HAZARD descriptions on page 355.

CAGE BALLS



Ultra-Lite Cage Balls

Half the weight of traditional cage balls on certain sizes.

Made with a 100% nylon, double stitched cover with an extra wide zipper opening for bladder insertion. The lightweight bladder is easy to inflate with our Heavy Duty Inflator #10305. The bigger the ball the more weight saving you will gain with the Ultra-Lite cage balls compared to traditional cage balls. **⚠ CHOKING HAZARD (6) - BALLOON.** Not for under 8 yrs.*

SZ.	WT.	SET	BLADDER ONLY	COVER ONLY
24"	2 lbs.	10531 \$49.99 set	10536 \$13.99 ea.	10541 \$38.99 ea.
36"	4 lbs.	10532 82.99 set	10537 30.99 ea.	10542 54.99 ea.
48"	5 lbs.	10533 115.99 set	10538 50.99 ea.	10543 69.99 ea.
60"	7 lbs.	10534 182.99 set	10539 76.99 ea.	10544 114.99 ea.
72"	9 lbs.	10535 226.99 set	10540 99.99 ea.	10545 137.99 ea.



40" CLOTH COVERED OVERSIZED BALL

ZONE Oversized Volleyball

Serve up some big fun with this huge volleyball.

Made with a washable polyester cover and durable vinyl bladder, this ball can withstand heavy play. It's perfect for group volleyball, field day, and push ball games. Measures 40" in diameter. **⚠ CHOKING HAZARD (6) - BALLOON.** Not for under 8 yrs.*



10321 40" Volleyball.....\$89.99 **SALE \$79.97 ea.**
 10807 Replacement Bladder for 40" Playballs.....38.99 ea.

40" CLOTH COVERED OVERSIZED BALL

ZONE Oversized Soccer Ball

You'll get a kick out of this giant sized ball.

Made with washable polyester covers and durable vinyl bladders, these balls will withstand heavy play. Great for crab soccer, field days, group volleyball and push ball games. Available in two styles - volleyball and soccer. **⚠ CHOKING HAZARD (6) - BALLOON.** Not for under 8 yrs.*



10323 40" Soccer Ball.....\$89.99 **SALE \$79.97 ea.**
 10807 Replacement Bladder for 40" Playballs.....38.99 ea

INCLUDES HEAVY POLY BLADDER! OUTLASTS VINYL BLADDER BY 3X!



Heavy Duty Cageballs & Pushballs

These super giant balls help develop coordination and cooperative play. Play games like crab soccer, volleyball with parachutes, or games that allow a large number of students to participate. Specially constructed multicolored nylon cover with polyurethane bladder. New improved heavy duty quality. **⚠ CHOKING HAZARD (6) - BALLOON.** Not for under 8 yrs.*

Sz/Wt	SET	BLADDER ONLY	COVER ONLY
18"/1.4 lb	10153 \$26.99 set	10167 \$13.99 ea.	10160 \$15.99 ea.
24"/2.4 lb	10154 37.99 set	10168 19.99 ea.	10161 19.99 ea.
30"/3.4 lb	10155 50.99 set	10169 29.99 ea.	10162 24.99 ea.
36"/4.9 lb	10156 66.99 set	10170 39.99 ea.	10163 29.99 ea.
48"/8.6 lb	10157 126.99 set	10171 76.99 ea.	10164 56.99 ea.
60"/13 lb	10158 184.99 set	10172 109.99 ea.	10165 87.99 ea.
72"/19 lb	10159 274.99 set	10173 185.99 ea.	10166 99.99 ea.

* Full **CHOKING HAZARD** descriptions on page 355.

OMNIKIN® BALLS



OMNIKIN® KIN-BALL®

This fast moving game develops physical, cooperative, social and intellectual skills. The game is played with 3 teams of 4 players. One team serves to another and that team has 5 seconds to serve to the next. The ball must never hit the floor which allows for a fun, fast moving game. The KIN-BALL® weighs less than 2 lbs. and is made of tough, waterproof 100% nylon for durability indoors and outdoors with a lightweight latex bladder. **⚠ CHOKING HAZARD (6) - BALLOON.** Not for under 8 yrs.*

- 10103 Official KIN-BALL® Pink 48" w/2 bladders \$331.99 ea.
- 10109 Official KIN-BALL® Black 48" w/2 bladders 331.99 ea.
- 10105 Bladder for 40" or 48" Ball (1 each)..... 60.99 ea.

OMNIKIN® Multi-Color KIN-BALLS®

This feather light, non-threatening balloon bladder ball is a great alternative to those heavy cageballs. The Multi-Colored ball comes in two smaller sizes and can also be substituted as a KIN-BALL® or used as a cageball. Made of tough, waterproof 100% nylon for durability indoors and outdoors. Feather-light (under 2 lbs.) **⚠ CHOKING HAZARD (6) - BALLOON.** Not for under 8 yrs.*



- 10091 Multicolor 40" w/2 Bladders \$283.99 ea.
- 10092 Multicolor 33" w/2 Bladders 207.99 ea.
- 10105 Bladder for 40" or 48" Ball (1 each) 60.99 ea.
- 10104 Bladder for 33" Ball (1 each)..... 47.99 ea.

OMNIKIN® AIR Ball®

Ultra Lightweight beach style ball. The heavy duty and waterproof nylon cover and exclusive polymer bladder bring the OMNIKIN® AIR Ball® to a new level of quality. Use this ball as a substitute for cageballs and discover a new excitement. Intended for faster sports, AIR Ball® is smaller than the other OMNIKIN® Balls to maximize the dynamics of bouncing. Its ultra-lightness helps to maintain the safety characteristic, while its construction assures durability. **⚠ CHOKING HAZARD (6) - BALLOON.** Not for under 8 yrs.*



- 10319 24" w/2 Bladders \$92.99 set
- 10320 18"/24" Bladder only 21.99 ea.

VIDEO ONLINE

OMNIKIN® Ultra Ball

The biggest lightest ball ever. These multi-colored lightweight balls are lighter than the KIN-BALL® and are not recommended as a substitute for it or other cage balls. Constructed with an extremely durable nylon cover and a unique nonthreatening balloon bladder make these balls safe. They are completely waterproof allowing them to be used in any pool. **⚠ CHOKING HAZARD (6) - BALLOON.** Not for under 8 yrs.*



- 10325 48" Ultra Ball w/2 bladders..... \$323.99 ea.
- 10326 60" Ultra Ball w/2 bladders..... 398.99 ea.
- 10105 Bladder for 40" or 48" Ball 60.99 ea.
- 10398 60" Bladder..... 68.99 ea.



OMNIKIN® Six Ball

Bright colors for eye tracking! This 18" diameter ball includes a 420D nylon cover and lightweight latex bladder which is water resistant. Sold in assorted colors or in a set of 6. **⚠ CHOKING HAZARD (6) - BALLOON.** Not for under 8 yrs.*

- 10342 SET OF 6 Balls w/Bladders \$359.99 set
- 10343 Assorted Colors 59.99 ea.
- 10320 18"/24" Bladder only 21.99 ea.

VIDEO ONLINE



OMNIKIN® Giant Footballs

Nylon covers are guaranteed for 3 years! A lightweight, 20" football shaped ball made from high quality 420D nylon with double stitched seams and durable bladder. Sold in a set of six or individually in assorted colors. Super Games Manual features 25 games. **⚠ CHOKING HAZARD (6) - BALLOON.** Not for under 8 yrs.*

- 10286 SET OF 6 OMNIKIN® Super Ball w/12 bladders \$399.99 set
- 10287 Assorted Colors each w/2 bladders..... 67.99 ea.
- 10518 Bladder only 39.99 ea.

BIG BALL INFLATOR INCLUDES 3 ADAPTERS!

Heavy Duty Inflator

Quickly inflates large valve balls!

This 4.5 horse power electric inflator includes a filter that helps avoid dust getting into the bladder during inflation. Includes 3 adapters for a variety of balls.

- 10305 \$269.99 ea.



* Full CHOKING HAZARD descriptions on page 355.

SCRIMMAGE VESTS



Mesh Scrimmage Vests

Extremely popular and affordable 100% polyester mesh scrimmage vest. Available in youth (ages 9 and under) or adult (ages 10 and up). Elastic bottom at waist.

66560 SET OF 6 Youth \$20.94 **SALE \$16.97 set**
 66561 SET OF 6 Adult..... 20.94 **SALE 16.97 set**

Description	Red	Orange	Yellow	Green	Blue	Purple	Each	SALE
Youth Size	22051	22057	22052	22053	22055	22058	\$3.49	\$2.87
Adult Size	22061	22067	22062	22063	22065	22068	3.49	2.87

36 Player 6 Color Pack

This pack contains 6 of each color vest in either youth or adult sizes. Includes a 24" x 36" black mesh bag.

66310 Youth..... \$108.60 **SALE \$99.97 pk.**
 66311 Adult..... 108.60 **SALE 99.97 pk.**

EXTREMELY POPULAR AND AFFORDABLE!



Mesh Scrimmage Vest Packs

24 or 36 packs in youth or adult sizes!
 Each 24 or 36 pack includes a 24" x 36" black mesh storage bag. 24 packs contain 12 of each color and 36 packs contain 18 of each color.

Description	RD	BL	GR	YEL	PU	OR	Pack	SALE
Youth Size 24 Pk	66192		66193		66194		\$99.75	\$67.97
Adult Size 24 Pk	66195		66196		66197		99.75	67.97
Youth Size 36 Pk	66304		66305		66306		108.60	99.97
Adult Size 36 Pk	66307		66308		66309		108.60	99.97



NUMBERED 1-12

Numbered Scrimmage Vests

100% Nylon mesh vest numbered 1 through 12. This set of 12, all one color, elastic bottom vests are great for team activities. They are numbered 1-12 on front and back. They are available in Youth (2nd thru 4th Grade) and Adult (5th Grade and up) and come in 4 colors.

Description	Scarlet	Gold	Kelly	Royal	Pack
Youth 12 Pk.	22013	22010	22011	22012	\$33.99
Adult 12 Pk.	22017	22014	22015	22016	33.99



Reversible Mesh Scrimmage Vest

Buy one scrimmage vest and get two colors. Eliminate all those different colors and styles. This medium weight 100% nylon vest has extra heavy stitching at all stress points, elastic waist bottom and available in adult sizes only (ages 12 and up). One size fits all.
Please Specify Color..... \$4.99 ea.

BLUE	RED	GREEN	GOLD	BLUE	GREEN	GOLD	RED	BLUE	GOLD	RED	GREEN
22004		22005		22006		22007		22008		22009	

SCRIMMAGE VESTS



ULTRA-MESH™ Scrimmage Vest

Extra tough polyester mesh that will withstand all the punishment you can dish out. Designed for all types of intramural activities. Heavy polyester mesh combined with a unique securely sewn neck, arm and bottom to prevent unraveling. Elastic free at the bottom makes for a more comfortable fit. Universal size fitting for individuals between 115 lbs. to 215 lbs.

66562 SET OF 6 Adult \$29.99 set

Description	Red	Orange	Yellow	Green	Blue	Purple	Each
Adult	22079	22080	22081	22082	22083	22084	\$5.99



ULTRA-MESH™ Vest Packs

Your choice of 24 or 36 packs!

We've picked our 2 most popular color combinations for you to choose from! Each 24 or 36 pack includes a 24" x 36" mesh storage bag. All vests are adult size for individuals between 115 lbs to 215 lbs. 24 packs contain 12 of each color and 36 packs contain 18 of each color.

Description	Red	Blue	Green	Yellow	Purple	Orange	Pack
Adult 24 Pk	66294		66295		66312		\$139.99 pk.
Adult 36 Pk	66296		66297		66313		199.99 pk.



Micro-Mesh Scrimmage Vests

Soft comfortable fabric with open hemmed bottom for an excellent fit.

Made from 100% micro mesh with reinforced seams and openings. Available in Youth (2nd thru 4th Grade) and Adult(5th Grade and up). Includes mesh bag.

66563 SET OF 6 Adult \$23.94 SALE \$16.97 set
 22123 SET OF 6 Youth 23.94 SALE 16.97 set

Description	Neon	Neon	Red	Blue	Purple	Neon	Each	SALE
Youth	22026	22027	22018	22019	22121	22122	\$3.99	\$2.87
Adult	22028	22029	22030	22031	22003	22002	3.99	2.87
Youth 24 Pk	66190		66333		22130		\$99.70	67.97
Adult 24 Pk	66191		66334		66534		119.76	67.97
Youth 36 Pk	66440		66441		22131		\$147.60	100.97
Adult 36 Pk	66442		66443		66535		179.64	100.97
Youth 72 Pk	66444		66445		22132		\$291.00	199.97
Adult 72 Pk	66446		66447		66536		359.28	199.97





Micro Mesh Numbered Scrimmage Vests
 Numbered 1 thru 12.
 100% nylon micro mesh with silkscreened numbers on front and back.

Size	Red	Blue	Price
Youth	22032	22033	\$46.99
Adult	22034	22035	46.99

TEAM IDENTIFICATION



Nylon Pinnies

Heavyweight pull-on nylon pinnies. Inexpensive and easy for kids to put on and take off. One size fits all. For 60-120 lb. children. Sold in sets of 12.

Description	Red	Orange	Yellow	Green	Blue	Purple	Pack	SALE
12 Pk.	22101	22107	22102	22103	22105	22108	\$25.99	\$21.97



Sleeve-It™ Arm Pinnies

So eye catching!

Easy for youngsters to put on- just slide up the arm and use the Velcro® closure to secure. Vinyl mini flags sewn in on sides. A more hygienic alternative to over the head pinnies. Made from polyester mesh, 16" long with adjustable 6" Velcro® closure top and elastic bottom. Set of 6 pinnies in one color. 24 player packs come with 12 of each color.



Description	Red	Orange	Yellow	Green	Blue	Purple	Pack
6 Pk	22112	22114	22113	22115	22116	22117	\$27.99
24 Pk.	22118	22119	22120	22120	22120	22120	104.99

EASY ELASTIC VELCRO CLOSURE!



Referee Pinnie

Quickly spot your referees!

Heavyweight nylon with easy elastic Velcro® closure. One size fits most.

22050.....\$4.99 ea.



Waist Pinnies

The easy to use identification pinnie.

These lightweight, tough vinyl belts have wide Velcro® strips that make them easy to put on and take off. Will fit any waist size 28" to 36".

Description	Red	Yellow	Green	Blue	Each
Fits All	22070	22072	22099	22071	\$2.99



Mesh Pinnies

Deluxe nylon mesh with no tie elastic waist band. Ventilated mesh, reinforced seams, easy on and off! Available in youth (elementary) and adult (middle school and up) sizes.

66564 SET OF 6 Youth.....\$22.99 set

66565 SET OF 6 Adult.....22.99 set

Description	Red	Orange	Yellow	Green	Blue	Purple	Each
Youth	22037	22038	22039	22040	22041	22042	\$3.99
Adult	22043	22044	22045	22046	22047	22048	3.99



Wristbands

Easy team recognition!

Just have students reach into a bag or box of wristbands and the teams are formed on their own. No arguments, hurt feelings or time lost. Highly visible and easily washable. Also excellent for tag type activities. Sold in a set of 6, 1 pair of each or individual colors in pairs.

22201 SET OF 6.....\$19.99 set

Description	Red	Orange	Yellow	Green	Blue	Purple	Pair
Pair	22202	22203	22204	22205	22206	22207	\$3.69

FLOOR MARKERS



Liquid Lines

A quick and easy way create boundary lines on gym floors!

Design custom borders and outlines whenever you need them with this all-in-one floor paint! One bottle equals up to 3 rolls of traditional 1" floor tape. Quickly apply the non-toxic, temporary floor paint using the bottle and application pad, leaving long-lasting and non-marring lines. To remove, simply spray with water and wipe with a rag. Store at room temperature.

29564 White, 1.5"L x 1.5"W x 5"H, 4 oz. \$11.99 ea.



FloormarX Floor Marker Set

Everything you need to create quick and durable floor lines and symbols!

Quick drying formula for long-lasting durability. Extra-large marker writes on sealed wood floors and other non-porous surfaces. The ink can stand up to heavy foot traffic. Use FloormarX Foot Wipes to wipe clean. The extra-large ink supply will last as long as five rolls of average floor tape. Markers: 5.5"L x 1.5"W. Wipes: 6.3" x 7.9".

29565 Marker/Wipe Set. \$39.99 set 29567 Green Marker \$11.99 ea.
29566 Blue Marker. 11.99 ea. 29568 Wipes 50 count. 19.99 ea.



Boundary Markers

Portable throw down vinyl lines and corners.

Change size for different games, class sizes and skill levels! These markers have a textured back. Lines measure 3"W x 13"L and corners are 10" x 10" x 3"W. Set includes 10 blue lines, 10 yellow lines, 2 blue corners and 2 yellow corners.

21010 \$55.99 **SALE \$ 46.97 set**



Long Lines

Bright optic yellow!

Sure to be seen, these non-slip poly strips are 24" long and 3" wide. Excellent for start/finish lines, relay races, boundary markers or for creating target areas. Sold in a set of 12.

21011 Set of 12 \$46.99 set



Roll Out Lines

Use as a long line or cut to fit to suit your needs!

Lines are available in 33' or 60' long sections and are 3" wide. Great for creating boundaries for mini courts, target areas or movement guides. Beveled edges are smooth and safe.

21160 3" W x 60'L \$93.99 ea.
21084 33'L x 3"W x 1/8" thick 50.99 ea.



Poly Start and Finish Lines

Perfect for the playground or in the gym.

Highly visible for safe play! Each line measures 3" x 48" in bright yellow with black raised lettering. Great for using for relays, recess and more!

21143 Starting Line \$5.99 ea.
21144 Finish Line 5.99 ea.



Heavy Duty Mat Tape

Extra heavy duty!

Use this clear mat tape for holding two mats together. Comes in rolls of 36 yards.

21080 3" Mat Tape \$7.99 ea.
21081 4" Mat Tape 9.99 ea.



Hand Held Tape Layer

Lays floor tape on gym floors.

Rubber rollers allow curved or straight lines. Can use 1" or 2" tape. All steel construction. 36" long handle.

21046 \$49.99 ea.



Floor Marking Tape

Heavy gauge vinyl designed to mark your gym floors, courts, or any hard smooth surface. Made of tough vinyl, this floor tape comes off clean and won't scuff your floors, but is strong enough to hold up to foot traffic and equipment. The 1" and 2" floor tape come in rolls of 60 yards and the 1/2" tape comes in 36 yards per roll.

66760 SET OF 6 1" \$24.99 pk.
66761 SET OF 6 2" 49.99 pk.

Description	Red	Orange	Yellow	Green	Blue	Purple	Black	White	Each
5"	21051	21057	21052	21053	21055	N/A	21054	21056	\$1.99
1"	21061	21067	21062	21063	21065	21068	21064	21066	4.50
2"	21071	21077	21072	21073	21075	21078	21074	21076	8.50

SPOT MARKERS

PREMIUM SPOT MARKERS IN 4 SIZES!



Premium Poly Spot Markers

Made in the U.S.A., won't rip or tear.

Poly Spot Markers are an ideal substitute for cones. Coordinate your stations with different color spot markers. Available in 5", 9", 12" and 19" sizes to create a multiple of spots on the floor. Made of durable PVC and can be used indoors or out. Made in the U.S.A. and quality is evident. Sold in sets of six in, 5", 9", 12" or 19"-one of each color, or individual colors in 9" only.

- 21089 SET OF 6 5" size \$15.50 set
- 21093 SET OF 6 9" size 21.99 set
- 21094 SET OF 6 12" size 37.99 set
- 21158 SET OF 6 19" size 94.99 set

Description	Red	Orange	Yellow	Green	Blue	Purple	Each
9"	21090	21087	21082	21083	21085	21088	\$3.99

JUMBO SIZE SPOT MARKERS



Jumbo 19" Rubber Spot Marker

Heavy duty, won't slip.

Use for stations, place markers, shooting stations and more. Set of 6.

- 21214 SET OF 6 \$61.99 set



Rubber Spot Sets

Colored Poly Spots at an affordable price.

Flat 9" or 12" rubber discs for indoors or out. Sold in a set of six, one of each color: red, green, blue, yellow, orange and purple.

- 21026 SET OF 6 9" size \$13.99 SALE \$11.97 set
- 21059 SET OF 6 12" size 28.99 SALE 24.97 set

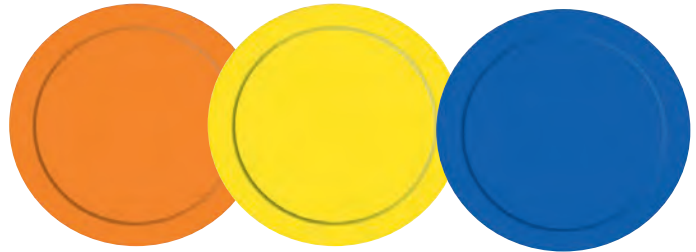

Individual Rubber Spots

Economically priced rubber spots.

Flat 9" rubber discs for indoor or outdoor. Sold individually or in set of 12.

Individual	Set of 12
21001 Orange only \$2.39 ea.	21150 \$19.99 set
21044 Yellow only 2.39 ea.	21151 19.99 set
21045 Blue only 2.39 ea.	21152 19.99 set



ZONE Hidden Spots

Flip them over to reveal the secret color.

These double sided vinyl spots are perfect for matching games and more. Trying advancing from spot to spot by turning one over and advancing to the color underneath. Work individually or in pairs. 10" diameter. Set of 30.

- 21213 \$119.99 SALE \$99.97 set



SPOT MARKERS



NEW

A to Z Alphabet Poly Spots

Keeps kids moving while promoting literacy!

These spots are a dynamic tool which can be used to enhance spelling, reading and vocabulary while simultaneously meeting PE standards. Use for stations, obstacle courses and more. Safe and durable molded PVC measures 9" across and only .200" thick. Bright, large letters are easy to read and will not rub off. Includes 26 spots.

70061 \$109.99 **SALE \$97.97 set**



Neon Orange Spot Markers

Numbered 1-30.

These bright spot markers measure 8.25" and feature a flexible slip resistant backing so they stay where you want them. Spots are made of vinyl and are numbered 1 through 30. Use for a variety of games and activities.

21200 \$68.99 **SALE \$57.97 set**



5" Number Spot Set

Use for stations, relays, as targets and more!

Molded poly vinyl spots will not tear or slide on floors. The 5" size makes these spots easy to transport, ideal for multiple game use, even for the classroom! Set of 30 spots, numbered 1-30. Made in the U.S.A.

21149 \$75.99 set



NUMBERED SPOT MARKERS

NEW

Numbered Spot Marker Sets

Large digits are easy to read.

Colorful vinyl spots measure 10" in diameter and have a slip resistant backing. Choose from sets #1-10 or #11-20 in 6 different colors or choose a complete pack with all 12 colored sets (#1-10 & #11-20 – 1 set of each color).

66810 Complete #1-20 Pack (1 set of ea. color - 120 spots total) \$239.99 pk.

Description	Red	Orange	Yellow	Green	Blue	Purple	Each
#1-10	21222	21223	21224	21225	21226	21227	\$23.99
#11-20	21228	21229	21230	21231	21232	21233	23.99



Poly Numbers

Count on fun with these!

Excellent for numbering stations, groups, sequencing activities and counting. Bright yellow 5" numbers are on 9" round blue spots for easy recognition and numbered 1-100. Made of durable non-skid vinyl that's easy to clean.

X21119 \$305.99 set



NEW

Fruits and Veggies Spot Markers

Learn about healthy eating while getting active.

Reinforce healthy eating habits during gym classes or recreational activities. Create fun circuit games or use to designate teams. Durable 9" markers are skid resistant and lay flat. Made of foam rubber with a neoprene cover. Set of 12.

74596 \$18.20 set



NEW

Marine Wildlife Spot Markers

Create exciting games and learn about sea life.

Perfect for numerous station and movement activities. Students will have fun exploring the ocean while learning about the names, sounds and movements of sea creatures. Set of 12. Durable 9" markers are skid resistant and lay flat. Made of foam rubber with a neoprene cover.

21221 \$32.99 set

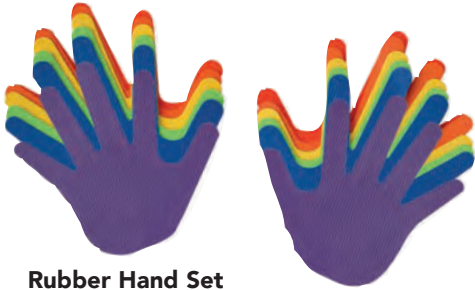

Rubber Hand Set

Give 'em a hand!

Point the way to fun with these colorful non-skid hand shaped floor markers! Constructed of all rubber non-slip material. 7"L x 6"W. Sold in a set of 12, 2 of each color.

21095 SET OF 12..... \$13.99 set

SPOT MARKERS



Rubber Arrow Sets

These rubberized arrow sets are a must for your classes! Direct groups for stations, circuit training, orienteering and more! Straight arrows are 15"L x 3.5" wide stem. Curved arrows are 10"x 10".

21028 SET OF 6 Straight..... \$13.99 set
21012 SET OF 6 Curved..... 13.99 set

**AVAILABLE
IN 2 SIZES**



Rubber Squares

A twist on round spot markers!

These heavy duty poly spot markers are a perfect addition to the traditional round markers. Use them as a substitute for bases, stations or targets in toss games. Available in two sizes. Sold in sets of six, one of each color.

21211 SET OF 6 9"..... \$16.99 set
21092 SET OF 6 14"..... 19.99 set



Rubber Foot Set

Use feet to show dance or aerobic moves, obstacle course markers, color identification and more!

Constructed of all rubber non-slip material. Measures 8.5"L x 4"W. Sold in a set of 12, 2 of each color.

21096 SET OF 12..... \$13.99 set



Rubber Star Set

A star is born!

Use in conjunction with the round and square markers and set up an intergalactic maze on your gym floor. Each star is approximately 9" across. Sold in sets of 6.

21091 SET OF 6..... \$13.99 set



Poly Numbered Bases

Extra heavy oversized rubber training bases.

Teach your beginning ball players with these large 16"x 16" rugged poly vinyl bases. Molded-in numbers 1-4 makes base running easy and fun.

Set includes three non-skid bases and home plate. 43258..... \$48.99 set



Basketball Spots

Numbered 1-10.

Ideal for shooting stations, drill placement or scatter on the court for designing plays. For indoor or outdoor play. 12" diameter.

21210..... \$60.99 set



Poly Traffic Sign Spot Markers

Bright and colorful Colors will not wear out or bleed.

Durable vinyl poly spots are useful in teaching traffic safety or for directing traffic in your gym! Each three pack contains 4 of each sign.

21115 Go/Slow/Stop Spot Set..... \$54.99 set
21116 One Way/Yield Spot Set..... 53.99 set

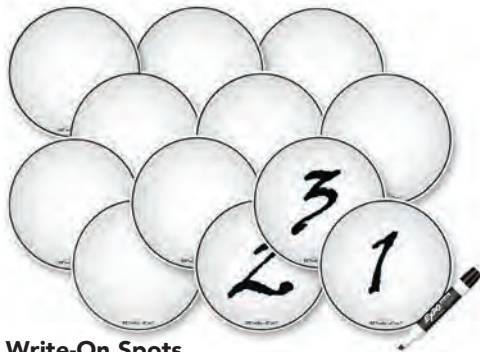

HotSpot Write-On Spots

Dry erase set allows you to customize or create new activities with your very own unique messages!

Possibilities include numbers, letters, directions, instructions, words, math symbols or team names! Set includes 12 ABS plastic spots. Spots measuring 8.5" in diameter, works with either dry erase or water based markers not included.

21212..... \$46.99 set



21139 - Jump Rope



21172 - Hoops



21118 - Calisthenics



21137 - Tubing Exercise



21140 - Exercise Ball



21171 - Cardio



21138 - Core Exercise



21135 - Yoga

HotSpots™

Wear resistant thermoplastic elastomer spots!

Each spot has a detailed explanation of how to perform drills with supporting graphics won't scuff or tear! Just spread them out and your stations are set. Includes 12 HotSpots™ and activity guide.

Specify Style Measure 8.5" in diameter..... \$44.99 set

CLASS PACKS



Directional Spot Pack

A 30 piece pack.

Includes:

- 1 set 21091 Star Spots
- 1 set 21095 Hand Spots
- 1 set 21096 Feet Spots
- 1 set 21012 Curved Arrow Spots
- 1 set 21028 Straight Arrow Spots

66718 \$64.99 pk.



Essential Spot Pack

A 54 piece spot set.

Includes:

- 1 set 21026 9" Rubber Spot Set
- 1 set 21059 12" Rubber Spot Set
- 1 set 21200 30 Pack Numbered Spots
- 1 set 21150 9" Orange Spot Set

66736 \$119.99 pk.



Plastic Cone Pack

A 90 piece pack.

Includes:

- 24 ea. 21017 9" Orange Cones
- 12 ea. 21024 12" Orange Cones
- 24 ea. 21032 Yellow Half Cones
- 24 ea. 21037 Orange Half Cones
- 1 set 21048 9" Cones

21168 \$116.80 SALE \$99.97 pk.



Plastic Cone Kit

All the 9" and 12" cones you need.

Includes:

- 1 set 66484 9" Orange 50 pack
- 3 sets 21048 9" Colored Set
- 1 set 66485 12" Orange 50 pack
- 3 sets 21049 12" Colored Set

66738 \$149.99 kit



3C's HotSpot™ Class Pack

Calisthenics, cardio and core!

No equipment needed! 36 spots & activity guides.

Contents:

- 1 set 21118 Calisthenics HotSpots
- 1 set 21171 Cardio HotSpots
- 1 set 21138 Core HotSpots

21208 \$134.90 SALE \$124.97 pk.



Elementary Movement Pack

For high energy or calming classes.

Includes:

- 1 set 21172 Hoops HotSpots
- 1 set 21139 Jump Rope HotSpots
- 1 set 21135 Yoga HotSpots

66737 134.90 SALE \$124.97 pk.

CONE TRANSPORTERS



Cone/Scooter Cart

Simply stack your scooters or cones on the two stacking poles!

Stores and transports eighty 12", fifty 18" cones, or a combination of cones and scooters. This rugged steel unit measures 47"H x 30"W x 18"D and features durable rubber wheels.

X36149 \$139.99 ea.



Cone Cart

A smooth rolling cone cart.

Holds 60 of the 12" PVC or 200 plastic cones. Features a 1" diameter steel tube frame with powder coat finish with 10" pneumatic wheels with roller bearings. Measures 45"H x 26"W x 16"D; weighs 30 lbs.

X36092 \$134.99 ea.



WEIGHTED RUBBER BASE

SlotCones™

The most versatile cone on the market!

Innovative slot design allows any size hoop or crossbar to be locked into the cone. Choose from 12 vertical positions or 5 horizontal (from 3" to 18" high). SlotCones™ are heavier than and twice as strong as a typical cone. Add optional weighted rubber bases for enhanced stability. Lock-In crossbars fit snugly into the horizontal slots. Cones: 18.5"H x 8"W. Crossbars: 40" long. Hoops not included.

21217 SET OF 6 SlotCones™ \$48.99 set

21218 SET OF 6 Lock-In Crossbars 40"L 34.99 set

21219 Weighted Rubber Base 8.75"L x 8.75"W (optional) 7.99 ea.

66773 SlotCones Activity Kit - 6 ea. of SlotCones™ & Lock-In Crossbars only 79.99 set

PLASTIC CONES



ZONE Cone Set

Slotted on top; connecting holes in body!

A multi-purpose cone that allows you to connect plastic poles to make hurdles or display instruction sheets. 12" plastic cone with 12 holes. Set includes 6 cones in 6 colors and 3 yellow 28" plastic connecting poles.

- 21195 TheZone Cone Kit- 6 cones & 3 poles..... \$55.98 **SALE \$35.97 kit**
- 21198 Set of 6 12" Zone Slotted Cones w/Holes 31.99 **SALE 25.97 set**
- 17141 28" Plastic Poles- 3 per set..... 7.99 set



Colored Cone Sets

Now in 3 sizes!

Lightweight, colorful, high-impact polyethylene cones and markers. Use indoor or outdoor for obstacle course markers, boundary markers, relay lanes, etc. Easy to stack and carry.

- 21048 SETOF6 9" Cone Set..... \$9.99 **SALE \$6.97 set**
- 21049 SETOF6 12" Cone Set..... 11.99 set
- 21162 SETOF6 18" Cone Set..... 24.99 set



Mini Markers

An inexpensive way to set up obstacles!

These 6.5" high markers provide an inexpensive way to set up obstacles, direct the flow of traffic, define boundaries, etc. They have a 3.75" diameter base for stability. Set of 48- 8 of each color.

- 21002 SETOF48.....\$64.99 **SALE \$49.97 set**

18"

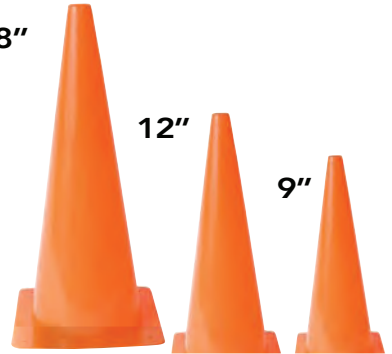

Plastic Cones

High visibility orange molded plastic cones.

Available in 9", 12" or 18" tall. These cones are inexpensive, light weight, easily stackable and are perfect for a number of activities such as game markers or station markers. Because they are light weight, it is easy to stack a number of cones and carry them out to your preferred destination.

	9"	PRICE	12"	PRICE	18"	PRICE
EACHES	21017	\$0.89 ea.	21027	\$1.69 ea.	21029	\$4.75 ea.
50 PACK	66484	39.99 pk.	66485	79.99 pk.	66486	199.99 pk.

18"

12"



9"

6"

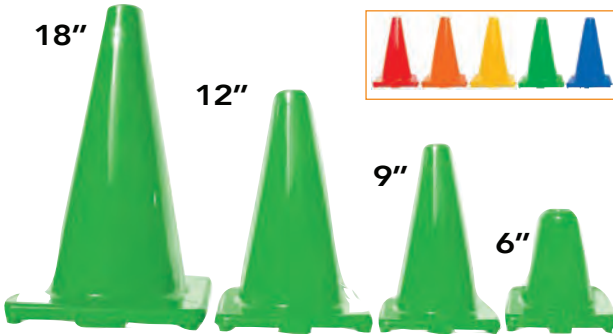

Poly Colored Cones

New one-piece construction, flexible and durable!

Available in 6 bright colors to identify team lanes and boundaries. Easy to stack and carry. Now available in 4 sizes for multi-use; 6", 9", 12" and 18". Mix and match for relays, obstacles or dividers.

- X21104 SETOF6 6" Size.....\$19.99 set
- X21176 SETOF6 9" Size..... 24.99 set
- X21106 SETOF6 12" Size 47.90 **SALE 39.97 set**
- X21107 SETOF6 18" Size 66.99 set

SIZE	RED	ORANGE	YELLOW	GREEN	BLUE	PURPLE	PRICE
12"	X21120	X21121	X21122	X21123	X21124	X21125	\$7.99 ea.
18"	X21126	X21127	X21128	X21129	X21130	X21131	11.25 ea.

36"

28"

SUPER HEAVYWEIGHT

18"

12"

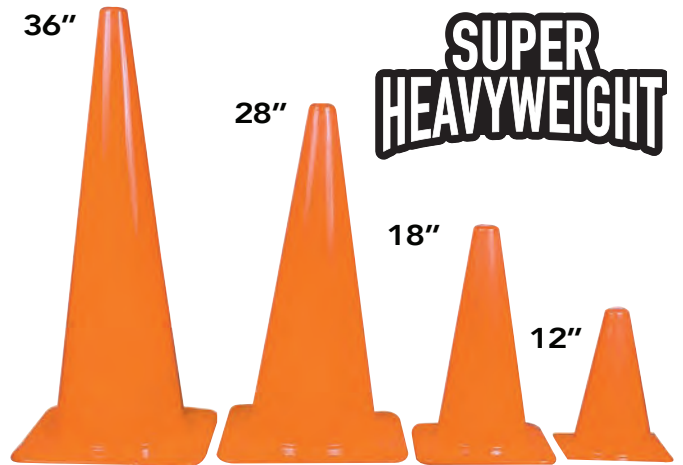

Heavyweight Traffic Cones

Heavy orange fluorescent vinyl.

Same durable type as used on highways. Four popular sizes that can be used with cone hurdles or by themselves as boundary markers and lane dividers.

- X21008 12"\$7.99 ea.
- X21009 18" 11.25 ea.
- X21040 28" 22.99 ea.
- X21043 36" Set of 4 only..... 144.99 set

HALF CONES

Jumbo Half Cones

Oversized with a 12" diameter!
Stands 5" high and made from flexible vinyl so it can be stepped on safely.



- 21186 Orange \$2.25 ea. 66482 Orange - Case of 48 ... \$94.99 cs.
- 21187 Yellow 2.25 ea. 66483 Yellow - Case of 48 94.99 cs.

Standard Half Cones

Flexible yet strong!
Molded plastic round disc shaped cone that stands 3" off the ground with a diameter of 7". They are flexible enough to be stepped on without breaking. Available in yellow or orange. Sold in eaches or a case of 50.



- 21037 Orange \$0.99 **SALE \$0.77 ea.**
- 21032 Yellow 0.99 **SALE 0.77 ea.**
- 66480 Orange - Case of 50 49.50 **SALE 34.97 cs.**
- 66481 Yellow - Case of 50 49.50 **SALE 34.97 cs.**



Standard Colored Half Cone Sets

Lightweight, colorful and safe.
Flexible half cones that stand 3" off the ground with a diameter of 7". They stack easily and are flexible enough to be stepped on without breaking. Set of 6.

- 21033 SET OF 6 \$6.99 **SALE \$5.27 set**

Standard Half Cone Class Pack

36 half cones and a carrying rack.
Sold in a set of 36, six of each color: red, yellow, green, blue, purple and orange. Wire Cone carrier comes with set and can be purchased separately.



- 21025 Half Cone Class Pack \$29.99 **SALE \$23.97 set**
- 21036 Half Cone Carrier-only 3.59 ea.

Mini Half Cone Class Pack

Flexible plastic collapses when stepped on.
Ideal for younger classes, indoor use and so much more. Measures 4.75" in diameter and stands only 1.5" high. Set of 48 includes 8 of each color with nylon carry strap.



- 21175 \$26.99 **SALE \$21.97 set**

PALOS POINTER!

WHICH CONE IS RIGHT FOR YOU?

JUMBO SIZE

STANDARD SIZE

MINI SIZE



12"
DIAMETER

7"
DIAMETER

4.75"
DIAMETER



Dome Cones Sets

Markers, obstacles or stepping stones.
Super strength polyethylene domes that can support up to 200 lbs! Stacks neatly on its own stacking/carrying pole. Cone size 7.75" dia. x 3.5"H. Set of 36: 6 of each color.

- 13050 SET OF 36 \$47.99 **SALE \$41.97 set**



Soft Dome Cones Sets

Collapsible dome cones.
The same versatility as our traditional Dome Cones but made with a softer material that collapses when stepped on. Offers a greater sensation for balance and won't crack. Stacks neatly on its own stacking carrying pole. Cone size 7.75" diameter x 3.5"H. Set of 36: 6 of each color.

- 13121 SET OF 36 \$47.99 **SALE \$41.97 set**



NEW

ZONE Cones & Noodle Kit

As many uses and configurations as you can imagine.
Create hurdles, obstacles and even arches. The flexible caterpillar connectors and bendable foam noodles makes this one of the most versatile packages available. Includes: (12) Zone Slotted Cones 12", (12) ea. of 10" and 6" Noodle Connectors, and (10) Foam Noodles 58"L x 2.75"D.
X66797 \$119.99 kit

CONE IDENTIFICATION



Station Board Holders
Excellent for stations!

The holder fits over cones, has a slotted top for the boards to fit and is made from polyethylene. White boards are dry erase, and made from a slick polypropylene. The holders measure 6" tall and the boards measure 8.5" x 11". Boards and holders sold separately in sets of 6 or together in a pack of 6 white boards and 6 holders. Dry erase pen and cones not included.

- 21201 SET OF 6 Station Board Holder..... \$21.99 **SALE \$14.97 set**
- 21202 White Boards Set of 6 19.99 **SALE 15.97 set**
- 21205 Station Board Pack- 6 White Boards & 6 Holders 41.90 **SALE 35.97 set**



Cone Folders
Great for setting up stations!

Simply insert an activity or instruction sheet into the clear pocket and place the folder over a cone. Folders have pockets on each side, made from sturdy vinyl and accepts paper up to 8.5" x 11". The 2.5" diameter hole allows for easy on and off use. Set of 6. Cones not included.

- 21192 SET OF 6..... \$49.99 set



Fitness Station Set

10 activities ready to go- anywhere!

You get the cones, the CONE-Sleeves™ and pre-printed fitness cards- ideal for teachers on the go, quick and easy stations, warm-ups and more! Just announce the repetitions you want and you are all set! Set includes: 10-12" plastic cones, 12- illustrated fitness cards and 1 set of 10 CONE-Sleeves™- 2 of each color.

- 52327 10 CONE-Sleeves™, 12 Exercise Cards & 10 cones \$54.99 set
- 55588 Exercise Cards only (set of 12) 5.99 set
- 21133 Pocket CONE-Sleeves™ -set of 10 19.99 set



Numbered CONE-Sleeves™
Slides on top of cones!

Brighten cones up with these cool collars! Available with an imprinted number. Great for organizing skill stations, marking fields, relay races or field day activities. Made from a heavy grade nylon with reinforced edges, these collars fit on cones 9" and up. Numbered set of 10. Each set includes 2 of each color. Cones not included.

- 21132 Set of 10..... \$18.99 set



Wall Organizers
Use for stations, activities, messages or students of the week!

Made from sturdy vinyl with 4 separate pockets that fit 8.5" x 11" paper and has grommets at the top for easy wall hanging. Measures 43.5"L x 12.25"W.

- 21193 Set of 6..... \$74.99 **SALE \$59.97 set**



Hang-Emz™
Dry-erase writing surface that hangs off the top of a cone!

Fits any size traffic cone. Individual hangers measure 11"L x 7.5"W. Use indoors or outside, water resistant. Sets include dry-erase pen and activity guide. Cones sold separately.

- 21155 Blank Set: 20 Hang-Emz™..... \$44.99 set



ADAPTED P.E.



ZONE 21" Grabby™ Ball

An oversized version of our popular Grabby™ balls.

The 21" Grabby™ ball has the same durability and lightweight characteristics as the smaller model, but is easier to track, catch and handle. New and improved needle valve inflation. Color: blue.

16384 Single Ball \$9.99 ea.



ZONE Grabby™ Balls

Inflate from 5" to 9" diameter.

Excellent for throwing, catching, kicking, squeezing, and bouncing. Non-toxic, soft textured PVC foam is as light as a balloon and as strong as a playground ball. New and improved needle valve inflation.

10136 SET OF 6 \$31.99 SALE \$24.97 set



True Flight Soccer Ball Set

Soft, friendly, and durable balls for non-intimidating play!

Rhino Skin® foam coated balls are tear resistant, easy to clean and sting-free. Bright colors and an easy to grip hole pattern creates an enhanced visual and tactile experience, excellent for adapted PE programs. A hollow core makes the ball well balanced and provides truer flight. Official size 5.

17290 SET OF 6 \$119.99 set

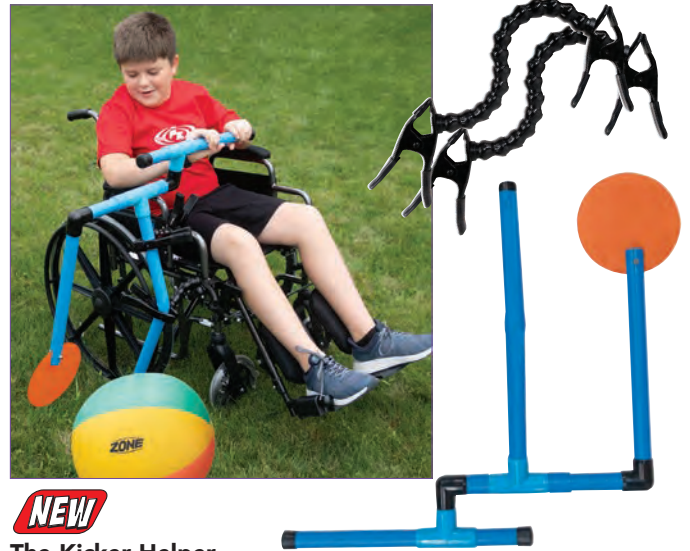

The Kicker Helper

Designed to help students in wheelchairs participate in recess games and physical education.

The Kicker Helper is an innovative tool that attaches easily to most wheelchairs via sturdy, bendable clamps. Students use their upper body to move the extra-long handle which swings the circular paddle. This action allows students, who otherwise are unable, to participate in sports that involve kicking and pushing motions. Kicker Helper works best with large, lightweight balls. Made of durable PVC. Assembled dimensions: 28.5"H x 29"W. Wheelchair not included.

66818 Kicker Helper \$349.99 ea.

66813 Kicker Helper w/ set of 6 (18") Heavyweight Beach Balls 369.99 set



ZONE Wheelchair Soccer Pad

Adjustable widths to fit most wheelchairs!

Never again use cardboard and duct tape to attach a blocking pad to the front of a wheelchair. Made from durable .5" thick closed cell foam. Has three different width adjustments and uses 4 Velcro straps and multiple attachment options to fit all wheelchair sizes and styles. Measures 21" L x 8"H. Wheelchair not included.

17170 \$49.99 ea.



ZONE POWGRIP BELL BALL

Includes two bells inside the bladders that make noise, helping vision impaired students track the progress of the ball when in use. They also include superior Cellular Rubber grips making it easier for vision impaired students to handle.

37587 Basketball Size 6 \$19.99 ea.

50173 Soccer Ball Size 4 19.99 ea.

ADAPTED P.E.

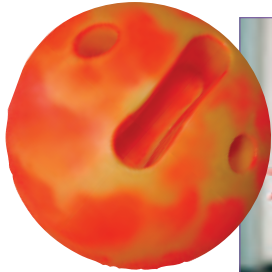

ZONE Adaptive Bowling Ball

Easy to grip and roll.

Special finger slot and multi-hole design makes this ball easier for special needs students to hold and release. Constructed of unbreakable vinyl. For indoor or outdoor use.

17243 \$29.99 ea.



ZONE APE Bowling Bell Bands

Add a bell to your favorite equipment.

Scrunchy style band with bells inside uses Velcro to add bells to standard items such as bowling pins for auditory reinforcement. Set of 10.

17252 \$24.99 set



Aluminum Bowling Ramp

Make bowling fun for everyone!

Not only great for students in wheelchairs, but for students with limited upper body strength and mobility. Simply line the ramp up with the pins, give it a slight push and you're in the game! Made of high strength aluminum alloy with clear anodized finish and easily assembles with push pins, no tools required. Assembled ramp is 58" long with four rubber feet to protect floor and add support. U-shaped rear frame is 25" x 25". Weighs 5 lbs.

X15180 \$219.99 ea.

Mesh Dribble Aid
Allows students to practice the dribbling motion of a real basketball!

Attach each end of the bungee cord to a fixed standard or wall hook, insert deflated junior size ball into the mesh bag, and inflate to full size. Students then push the balls downward. The innovative designs ensures the ball will return to the original position. Includes one mesh ball bag with stretchable opening, affixed bungees and swivel attachments.

39236 \$16.99 ea.



ZONE Beeper Ball

Perfect for audio guided activities!

The 8" foam ball has a medium density, thick vinyl cover and can be thrown, kicked and bounced just like other foam balls. The beeper is encased in a hardened module that slides into the ball and generates a loud, sharp beep. Ideal for limited vision classes or use blindfolds with sighted players. Module can be removed and used without the ball. Operates for approx. 170 hours on one 9V battery. Battery not included.



16095 8" Ball & Module \$52.99 ea.



True Flight Play Ball Set

Soft, friendly, and durable balls for non-intimidating play!

Rhino Skin® foam coated balls are tear resistant, easy to clean and sting-free. Bright colors and an easy to grip hole pattern creates an enhanced visual and tactile experience, excellent for adapted PE programs. A hollow core makes the ball well balanced and provides truer flight. Size 5"D.

17292 SET OF 6 \$49.99 set



True Flight Junior Football Set

Unique design helps prevent injuries during play!

Rhino Skin® foam coated balls are tear resistant, easy to clean and sting-free. Unlike traditional footballs, these balls will not hurt if a catch is missed – thanks to the hollow core. Bright colors and an easy to grip hole pattern make them a great addition to adapted PE programs. Junior size 8.5"D.

17291 SET OF 6 \$64.99 set

ADAPTED P.E.

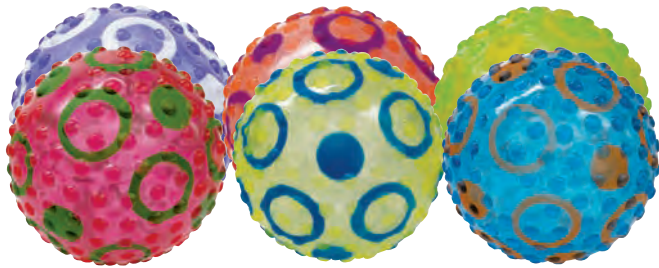

ZONE Bump Balls

A soft, dimpled multi-purpose ball.

Inflatable, soft vinyl ball with molded in bumps is ideal for indoor or outside. Inflates up to 8" dia.

10464\$25.99 set

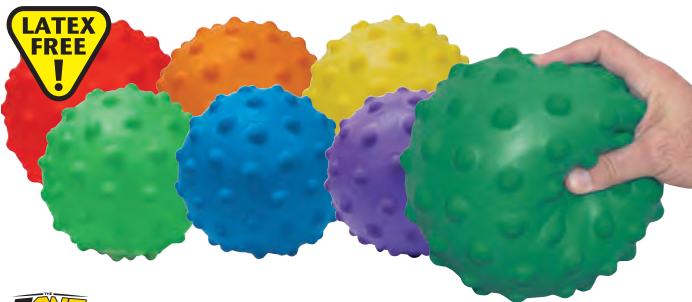

ZONE Nobbie Grabby™ Balls

The neat spongy feel of a Slo-Mo™ ball covered with bumps!

Excellent grip for easy catching. The tactile skin is extremely durable yet thin and lightweight. Inflates from 7" to 10". Sold in a set of 6.

10044 SET OF 6\$29.99 set



ZONE Grab Ball Set

Flexible vinyl rubber construction makes this ball long lasting and super durable.

Kids can step on this ball and it comes right back to its round shape.

Easy to throw, easy to catch, always keeps it's shape. Soft and safe. 6" diameter, sold in a set of 6.

17156 SET OF 6\$45.99 set

ZONE Tumble-N-Ball

Open design makes it easy to catch and toss!

Unique design and low bounce/ low rebound features also makes this an excellent Adaptive PE addition. Made from woven plastic strips covered in soft, foam backed fabric. 7" diameter.

17241\$13.99 SALE \$9.97 ea.



FOR LEFT AND RIGHT HAND THROWERS



ZONE Catch Gloves

For left and right handed players!

These confidence building gloves have hook and loop palms and patches that catch the ball easily for younger players. Gloves are made from flexible neoprene. Includes 6 gloves and 6 soft cloth balls.

16195 SET OF 6\$64.99 SALE \$49.97 set



NEW

Palm Catchers

An excellent option for students with difficulty wearing traditional gloves or mitts. Each set includes a pair of neoprene wraps, with a Velcro patch on the palm, and a 3.5" diameter fleece ball. Wraps are easily placed around the hand and secured with Velcro.

17397\$12.99 pr.



ZONE Tendril Balls

Rubber band-like tentacles cushion on impact.

Silky soft, easy to catch and super safe! A wonderful tactile ball with its eye catching colors, limited bounce and roll. Use for a wide variety of games and activities! Available in two sizes. Set of 6 available in 3.5" size only.

10281 Oversize 4.5" Multi-Colored\$4.99 ea.

10282 Regular 3.5" Assorted colors 4.99 ea.

16142 SET OF 6 Regular 3.5" 31.99 SALE 24.97 set



Fleece Ball Mega Pack

36 balls in a mix of colors and sizes!

You get 18 of the 3" and 18 of the 4" soft fleece balls with a mesh bag for storage.

66293\$123.99 SALE \$89.97 pk.

ADAPTED P.E.

ZONE Pirate Wheel

Fine motor skill development tool. Use your fingers to move the balls through the Pirate wheel. Each tip is color coded and has a matching color ball. The goal is to get each colored ball in the correct spot. Made with a clear and durable vinyl. 6" diameter and 11"L. 17247 \$14.99 ea.



ZONE Rumble Roller

Vibrating sensory aid. The peanut shaped Rumble Roller has weighted balls on the inside that create both a rumbling sound when rolled and a vibrating sensation that can be felt when rolled back and forth. Great for students who need audio and sensory stimulation. Can also be used as a standard peanut shaped fitness ball. Item is approx. 20"L w/12" diameter. 17248 \$24.99 ea.



Tactile Discs

Challenges children's sense of touch on both hands and feet!

Each set contains 5 pairs of discs. Each pair has its own tactile structure and color. Ideal for tactile recognition, matching, patterning, color recognition, and blindfold games. Set includes 5 large 10.5" discs, 5 small 4.5" discs, blindfold, storage bag, and instructions. Latex-free rubber construction. Weight capacity 220 lbs. Choose from 3 sets.

- 17293 Set 1 - 10 Discs \$96.99 set
- 17294 Set 2 - 10 Discs 96.99 set
- 17295 Complete Set - 20 Discs 183.99 set



BENDABLE NOODLE CONNECTORS Squats



Foam Noodles & Noodle Connectors

Hundreds of uses outside of the pool! Create safe obstacle courses, make foam hurdles, target circles or cut them up and use as pins or taggers. Makes a great fitness item as well. Connectors are bendable foam inserts that join multiple noodles into various shapes, targets, goals, crossbars and more! Choose from two lengths of connector. X58021 Foam Noodles - Box of 12, Assorted Colors, 58"L x 2.75"D \$75.99 box
32363 Noodle Connectors 6" - Set of 12 31.99 SALE 24.97 set
32362 Noodle Connectors 10" - Set of 12 39.99 SALE 29.97 set

* Full **CHOKING HAZARD** descriptions on page 355.

ZONE Whirl-O-Rope

A great jumping trainer! Ideal for limited spaces or novice jumpers learning proper technique. Develops rhythm, timing and provides a great aerobic workout. Plastic handles, vinyl cord and plastic balls to improve rotation. Sold as a pair or a class pack of 24 pairs.

- 12049 Whirl-O-Rope \$7.99 SALE \$5.97 pr.
- 12058 Class Pack- 24 pairs 191.76 SALE 139.97 pr.



Jump Rope Pad

Designed for visually impaired students. Students start in the center and jump rope. When they feel that they have moved and are no longer jumping on the pad, they stop, re-center, and start again. This makes it safe to have many vision impaired students jumping rope without having to worry about them coming into contact with other students. Made from a closed cell foam, like yoga mats, with a 35" diameter. Jump rope not included

- 12131 \$46.99 ea

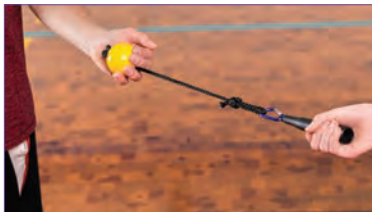

Assisted Running Handles

Created to aid students with vision impairments. The student with good vision helps guide the student with vision impairment by each holding one end of the handle. Handle is connected by a cord which stretches to prevent falls due to trips or stumbles. Handle may be dropped immediately if runner needs to stop. Includes 2 interchangeable handles (standard & ball grip) and 14" L rope. 17288 \$24.99 set

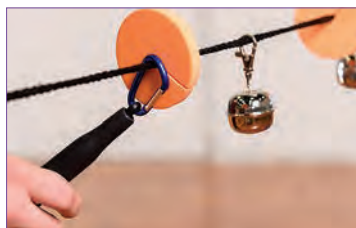

Assisted Running Rope

Allows vision-impaired students to run without a partner! Move from one end to the other by grabbing a handle and moving alongside the rope. Attached noise makers and foam stoppers help slow down runners and alert them to the end of the rope. Reset foam stoppers after run. Includes: 6 handles and 75 ft. long rope. **CHOKING HAZARD (1) - SMALL PARTS.** Not for under 3 yrs.*

- 17287 \$57.99 set

ADAPTED PE



Rainbow Mesh Tunnel
Great for Adaptive PE!

Made of a durable stretchy nylon mesh with two handles to hold open at each end. The student crawls through the tunnel and the teacher uses the handles to hold one end to control the difficulty level for the student. Tunnel is 95" long.

17166 \$45.99 ea.



Peekaboo Animals Sleeves

Stretchy nylon sleeves that you use with the MAC-T Sea Critter set. Students have to put the sleeve over the Sea Critter and then move the Sea Critter through the sleeve until it comes out the other end. This is great for Adaptive students who need to fidget and work on finger dexterity. Set of 6 sleeves.

26089 Sleeves with Sea Critters \$47.99 set
26090 Sleeves only Set of 6 16.99 set



ZONE Balloon Badminton Paddles

Perfect for balloons, tendlil, fleece and other lightweight balls. An alternative to traditional badminton paddles, these have a lightweight 11" diameter wire frame with nylon cover, a strong micro mesh hitting surface, and contoured foam handle. 18" long. Includes 30 balloons.

⚠️ CHOKING HAZARD (6) - BALLOON. Not for under 8 yrs.*

15993 SET OF 6 with 30 balloons \$84.99 set
10217 7" Balloons (144ct) 7.99 bag
10216 9" Balloons (144ct) 9.99 bag
10215 11" Balloons (144ct) 17.99 bag



APE Assisted Cannon Launcher Set
Let it go and watch it fly!

Designed for students in Adapted PE programs, learn cause and effect through the fun of launching balls and cannon cubes from our Zone Cannon Launchers. As an alternative to stomping, students or teachers use the eyebolt and rope to lift a vinyl weight over the launcher. The weight is then released, landing on the launcher and firing the ball or soft cube. Safe for all gym floor types. Set includes: 2 POWRBases, 2 tall posts, crossbar, and APE Conversion Kit (vinyl weight, rope, and eyebolt). Launchers and balls sold separately.

30259 Complete Set: 2 POWRBases, 2 Tall Posts, Crossbar, APE Conversion Kit \$299.99 set
17251 APE Conversion Kit - Vinyl weight, rope, eyebolt 19.99 set
17414 Single Cannon Launcher w/6 Foam Balls 32.99 ea.



PLEASE CALL FOR FREIGHT QUOTE

Giant Top - Rocking Disc

Helpful for kids who have trouble with core stability and bilateral coordination. Students develop physical coordination and gain vestibular stimulation when they spin, rock and sway. Raised edges helps to prevent finger pinching or loss of air when flipped over. Fits 1 to 2 children (Ages 3+). Durable indoor/outdoor plastic. 30.5"D x 17"H.

C17289 \$79.00 ea.



Balance Dome

Develop core stability and strength.

Use for multiple exercises and can be used upside down for additional Adapted PE activities. Made from strong vinyl construction. Dome measures 8" high when inflated and has a 17.5" diameter.

16669 \$46.99 ea.

*Full CHOKING HAZARD descriptions on page 355.

BRAINball™ A PHYSICAL EDUCATION CROSS CURRICULAR SYSTEM

"Learning through play."



What is BRAINball™?

BRAINball™ is an innovative and unique physical education learning system that merges physical activity and academic learning through play. Instructors and students use 100 mini soccer and basketballs and 100 lesson plans to develop math, reading, grammar, spelling, anatomy and foreign language skills. In addition to the physical benefits, significant improvement will be seen in gross and fine motor skills, cooperative and cognitive learning. BRAINball™ can be incorporated into Adapted Physical Education programs as well as those teaching students with learning disabilities, such as dyslexia.

BRAINball™ is broadly adaptable across elementary and secondary grades, and while an excellent tool for physical education, it is also perfect for use in the classroom, after-school, recreation and sports programs.

Why use BRAINball™?

Developed by the University School of Physical Education, Wroclaw, Poland in 2002, BRAINball™ has almost two decades of proven research published in numerous books, research publications, and doctoral dissertations. See our website for more information. Ask us how to set up a professional development workshop at your school.

What does BRAINball™ include?

Each set includes a lesson book filled with 100 games/activities, 100 mini basketballs and soccer balls (size 3) in five colors – red, orange, yellow, blue and green – and premium equipment bags with carry strap. There are 40 yellow and 40 green basketballs with letters (upper & lower case) and numbers, 8 red and 8 blue soccer balls with math symbols, and 4 orange "wild card" (blank) balls. BRAINball™ book is not sold individually.

49082 BRAINball™ Set - 100 balls and 100 lesson plans..... **\$789.99 set**

Skillastics®

Engage up to 100 children at the same time!

Maximum participation • Incorporates academic principals like STEM, math & reading • Aligns with P.E. standards



Skillastics® Activity Systems

An innovative twist on traditional circuit training systems!

Players set-up mats throughout playing area and use task cards to assign repetitions based on skill level. Players jog to the big mat, roll their die and move their marker to an activity based on the number rolled. Players jog back to the team (mini mat), points out activity and team completes the task based on assigned reps. Play is repeated. All kits include: 1 - 5'x7' big mat, 6 - 20" x 27" mini mats, 6 colored dice, 6 beanbag markers, 26 - 5" x 7" laminated task cards, instructional DVD/manual, storage bag. ⚠️ CHOKING HAZARD (1) - SMALL PARTS. Not for under 3 yrs.*

Skillastics® is a research-based physical activity system that combines active, academic, social, emotional, and cooperative learning with the development of fitness and or sport skills development. Over 10 million students are enjoying the benefits of Skillastics®!

Speed Stacks® Skillastics® Set

Combines the best of two worlds!

Learn Sport Stacking through the proven Skillastics® method. It offers 26 unique activities that enhances MVPA while simultaneously increasing Sport Stacking agility and skills. Includes: 1- 5'x7' big mat, 6 - 20" x 27" miniature mats, 6 colored dice & beanbag markers, 26 - 5" x 7" laminated task cards, instructional DVD & manual, backpack storage bag. (Speed Stacks cups sold separately. Recommended 1 set per student.)

17274 Speed Stacks® Skillastics® Set \$229.99 set

16388 Speed Stacks Cups, Set of 6 119.94 set



Basketball Skillastics™

37207 \$229.95 set



Soccer Skillastics™

50799 \$229.99 set

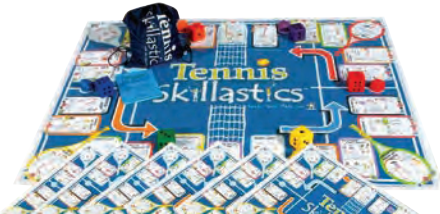

Tennis Skillastics™

41018 \$224.99 set



Volleyball Skillastics™

52205 \$229.99 set



Fitness Extreme Skillastics™

52512 \$229.99 set



Let's Move in School Skillastics™

16069 \$299.99 set



Fitness Skillastics™

52233 \$299.99 set



Character is Cool Skillastics™

53248 \$299.99 set



STEM Skillastics™

16835 \$299.99 set



Half Pint Skillastics™

52995 \$114.99 set



Skillastics™ Nutritional Card Set

52206 Nutritional Card Set \$64.99 set

53861 Lower Elementary Card Set 69.99 set

* Full CHOKING HAZARD descriptions on page 355.



TARGET OPTIONS



Target mat & Crossbar
Secure to crossbar and tall posts



Target Mat Only
Hang your own targets



ZONE POWRBase
Single bolt system locks posts in place



Tall Side Post
Adjusts from 61" - 95"H



Crossbar Only
Support for target mat: 8.3' L

Swivel Joint Connector
Connect multiple systems at angles

ZONE Dual Sided Target Mat System

The most value and action packed gaming system in the industry. Limited only by the imagination, the Target Mat is a dual-sided, Velcro® lined mat designed to add excitement, value, and versatility to PE and Adapted Physical Education Programs. Apply various cloth targets to the mat and use accessories such as Cannon Launchers, Cannon Cubes, Target Balls, and more to play fun group and relay games. Use the optional Crossbar to secure multiple mats side-by-side to create an affordable gym divider. Create angled mat configurations using the optional Swivel Connector. Use the mat alone to play no-peek volleyball. Dimensions: 8.25'W x 5'H.



Swivel Joint Connector

ALLOWS YOU TO CONNECT MULTIPLE SYSTEMS AT VARIOUS ANGLES



Choose the right package for your class!

- X30257 Super Deluxe Set: Target Mat, Crossbar, 2 POWRBase, 2 Tall Posts, 1 set ea. of - Alien Targets, Bullseye Targets, Sticky Cannon Cubes, Target Ball \$699.99 set
- X30256 Deluxe Set: Target Mat, Crossbar, 1 set ea. of - Alien Targets, Bullseye Targets, Sticky Cannon Cubes, Target Balls (Bases and Posts Sold Separately) 449.99 set
- X30255 Target Mat & Crossbar 159.99 set
- 30252 Target Mat (only) 99.99 ea.
- X30242 Zone POWRBase: Single bolt system locks posts in place 79.99 ea.
- X30243 Tall Side Post (60" - 95"): Locking system adjusts from 61" - 95"H 64.99 ea.
- X30253 Crossbar (only) 8.3'L: Support for target mat: 8.3' L 49.99 ea.
- 30260 Swivel Joint Connector: Connect multiple systems at angles 14.95 ea.

ZONE Alien Target Set

Not your typical little green invaders. These soft cloth targets are designed to be secured to a Velcro® surface, such as the ZONE Target Mat. Launch Sticky Cannon Cubes at them or use the assorted parts to create fun relay puzzles races. Each set includes 6 aliens - 36 pieces total.



30254 SET OF 6 \$199.99 set

ZONE Bullseye Target Set

Designed for use with The ZONE Target Mat System. The large colorful bullseyes are made of a soft cloth and can be secured to a Velcro® surface. Launch Sticky Cannon Cubes at them to see who can get the most points. 27" diameter.



17250 SET OF 6 \$99.99 set



ZONE Cannon Launchers

So much fun, no one can resist stomping!

Launchers are one of the most exciting and innovative products in the PE market. Students place one of the included foam balls, or optional soft cubes, into the mouth of the device. He or she then gives it their best stomp and watches in awe as it goes flying through the air towards the intended goal. The ZONE Launchers are perfect for group games or field days. They go especially well with The ZONE Target Mat System. Find exciting game ideas at pewithpalos.com. Measures: 9.5"W x 5"H. Choose from a set of 6 or 1 launcher. Includes foam balls.

- 16178 SET OF 6 w/ 36 Foam Balls..... \$159.99 set
- 17414 Single Launcher w/6 Foam Balls, Assorted Colors..... 32.99 ea.



ZONE Cannon Cubes

Choose from Sticky Velcro® or regular cubes.

Soft, polyester filled cubes are designed to fit into Cannon Launchers, and are also safe to toss. Sticky Cubes have Velcro® on the sides and will stick to all ZONE Targets sets. Includes 12 cubes: 2 of each color. Measures: 3" x 3" x 3".

- 26013 Standard Cubes Set of 12..... \$29.99 set
- 17249 Sticky Cubes Set of 12..... 45.99 set



ZONE Target Balls

Excellent for target tossing and even golf chipping.

Each ball has a textured surface and 6 Velcro® dots which makes them ideal for use with all ZONE Target sets. Students can also use with ZONE golf clubs to practice chipping skills. Easy to grip baseball size. (Does not fit in Cannon Launchers)

- 17253 SET OF 6..... \$19.99 set

GROUP GAMES



ZONE Alien Spaceship Battle

Which team will be the first to stop the alien invasion?

Teams place their ships randomly on their side of the court. The weighted alien targets are placed on each spaceship. Teams toss foam balls, or flying discs, at the opposing targets. First team to knock them all over wins. Use targets and ships for a fun spin on bowling. Find multiple game variations at pewithpalos.com. Each set includes: 17 green aliens, 17 orange aliens, 5 green UFO's, 5 orange UFO's.

- 17228 Alien Spaceship Battle - 34 Alien Targets & 10 UFO Bases \$164.99 set
- 66824 Alien Spaceship Battle & (18) 5.5" Easy Grip Foam Balls (10569)..... 299.99 set



ZONE Flying Saucer Face Off

An exciting spin on the original Alien Spaceship Battle.

Gameplay is similar to the rules of Alien Spaceship Battle. however, additional strategy is needed. Teams arrange their ships and targets on their side of the court. Soft ZONE DodgeDISCS are placed on the baselines. At the signal, students launch their flying saucers (discs) at the opposing alien targets. The first team to knock them all over wins. Game includes 34 weighted alien targets, 10 foam UFO bases and 18 DodgeDISCS.

- 66825.....\$359.99 set



ZONE Weighted Target Bowling Set

A 9" tall, narrower, colorful alternative to the traditional white pin.

Made with a durable foam rubber cover and a weighted base to prevent tipping, The Zone targets add a new twist to bowling. Use for relays and targeting games as well. RUFFSKIN bowling balls include 2 sets of holes and are made with a durable polyurethane coating. Set includes: 60 Targets (10 sets of 6) and a set of 6 RUFFSKIN bowling balls.

- 66794.....\$339.99 set



ZONE DodgeDISC

A softer and lighter alternative to the DodgeBee® Disk

Use as a non-threatening substitute to hard disks. Also great for catch and target games. Constructed of a durable nylon cover with foam inserts. DodgeDISC game instructions included. 10" diameter. Color may vary.

- 17242 Single, Assorted Colors \$13.99 SALE \$9.97 ea.
- 17368 SET OF 6.....\$69.99 SALE 54.97 set



ZONE FlipZ

So many uses, you'll flip!

FlipZ have a unique design and colors which make them versatile and an exceptional value for any group program. Teams can compete to flip the most of their color on top in a set time. Try a new spin on catch-a-ball with partners. Also great for pyramid stacking, relays and as ball holders. Made from safe and durable foam rubber. Set of 24.

- 17206.....\$139.99 SALE \$114.97 set



ZONE Weighted Knock Down Targets

Add more fun to any game... the uses are endless.

These 9" targets have a durable, textured foam rubber cover, with a weighted base to prevent easy tipping. Use as station markers or replacements for cones during races. They make exciting alternatives to traditional bowling pins or relay batons. Set them up and then knock them down.

- 17227 SET OF 6.....\$38.99 SALE \$27.97 set

GROUP GAMES



ZONE Straps & Flags

Create a multitude of cooperative games! Straps are 2" wide with tabbed ends for easy removal, hook and loop design allows for multiple belts to be connected and multiple flags on each belt. Super Flags measure 15"L x 1.5"W and are made from nylon webbing with hook tabs for easy attachment to straps. Medium straps measure up to 44" and large up to 56".

BELT SIZE	RED	ORANGE	YELLOW	GREEN	BLUE	PURPLE	PRICE
MEDIUM	32194	32195	32196	32197	32198	32199	\$3.99 ea.
LARGE	32253	32254	32255	32256	32257	32258	4.99 ea.
FLAGS	32206	32207	32208	32215	32210	32211	0.99 ea.



ZONE 12 Belt Class Packs

Each pack includes 12 belts; 6 of each color, 36 flags; 18 of each color, and mesh storage bag.

BELT SIZE	YELLOW	BLUE	RED	GREEN	ORANGE	PURPLE	PRICE
MEDIUM	32260		32261		32262		\$79.99 pk.
LARGE	32263		32264		32265		89.99 pk.



ZONE 36 Belt Class Packs

Each pack includes 36 belts, 108 flags, and mesh storage bag.

32266	Medium 36 Belt Class Pack	\$239.99 pk.
32267	Large 36 Belt Class Pack	269.99 pk.



ZONE Ice Cream Scoop Relay

We all scream for ice cream!

Each team has one of six colored foam ice cream scoops. The goal is to be the first team to collect all six colors of ice cream scoops. Includes 6 ice cream cones and 36 ice cream scoops.

17204..... \$89.99 set



ZONE Giant Egg and Spoon Set

A large version of the classic egg-and-spoon race!

Develops hand-eye coordination and balancing skills. Eggs and spoons can easily be used in other activities. Both eggs and spoons are covered in a soft fabric. Includes 6 eggs measuring 12" x 20" and 6 spoons measuring 8" x 15". Sold in a set of 6.

17161 SET OF 6..... \$99.99 set



ZONE Hidden Spots

Flip them over to reveal the secret color.

These double sided vinyl spots are perfect for matching games and more. Each colored spot has a random color on the opposite side. Partners take turns tossing a ball to each other. The thrower looks at the color underneath after they toss the ball and then moves to a spot of that color. Play is repeated until time runs out. Vary gameplay by using soccer balls, rings and more. Work individually or in pairs. 10" diameter.

21213..... \$119.99 SALE \$99.97 set

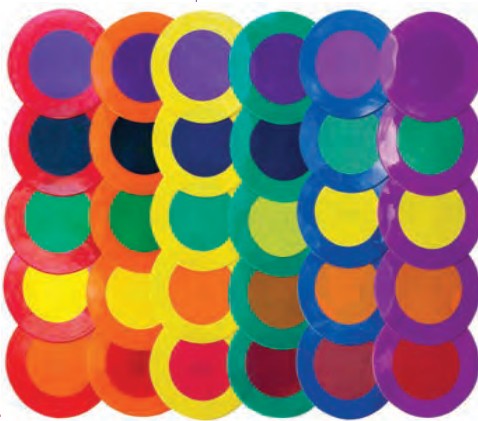

Tchoukball

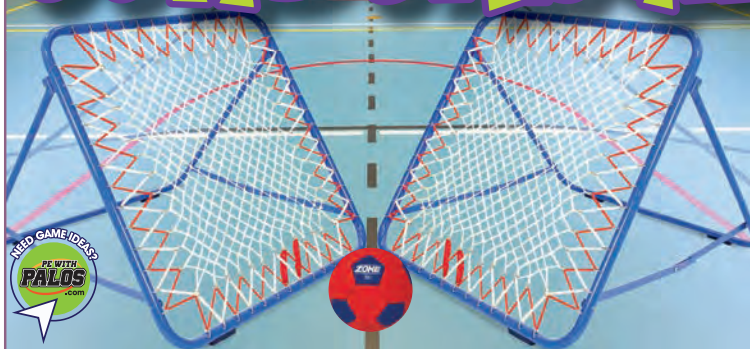

Tchoukball

Fast moving sport blending skill and strategy!

The object of the game is to score points for your team by throwing the ball at the net in such a way the opposing team cannot catch the rebound. Teams rely on quick passes to move the ball down the court before taking their shot at the net-there's no blocking or interference. Dropped passes result in a change of possession. Can adapt to many class sizes for indoor or outdoor play. Both sets include two 39" square super taut angled nets, 1 Tchoukball (middle school uses size 1 ball and high school uses size 2 ball) and rules of the game..

X15900 Middle School Set.....	\$449.99	SALE	\$349.97 set
X15979 High School Set.....	449.99	SALE	349.97 set
X15953 Nets only, 39" x 39", 20 lbs.....	399.99	SALE	329.97 pr.



PALOS RUFFSKIN™ Foam Team Handball/Tchoukball Set

High bounce and high density foam with thick vinyl cover!

Great rebound off nets for excellent Tchoukball play. Firm foam yet soft enough for a solid grip. Ideal for team handball and other tossing games.

16078 SETOF6 Size 0 Elementary School	\$59.99 set
10592 SETOF6 Size 1 Elementary/Middle School.....	66.99 set
10593 SETOF6 Size 2 High School	74.99 set
16092 Size 0 Elementary School (assorted colors)	10.99 ea.
10595 Size 1 Elementary/Middle School (assorted colors)	11.99 ea.
10596 Size 2 High School (assorted colors)	12.99 ea.

Trial Team Handball

Safe play and true bounce!

Italian-crafted, 3 ply, rotationally molded with handball pattern seam-free covers. Soft and safe for all ages with professional playability. Slightly textured, latex free non-slip surface. Colors may vary.

10001 Size 1 Junior 6.5"..... \$33.99 ea.



ZONE Tchoukball/Team Hand Ball

Same ball used for Tchoukball.

Lite balls constructed with a synthetic hand stitched tacky cover, an ideal substitute for a soft playing team handball. Colors may vary.

13087 Size 1 Elementary/Middle School.....	\$21.99	SALE	\$15.97 ea.
13088 Size 2 High School.....	21.99	SALE	15.97 ea.



POWRGRIP Tchoukball

Great grip for easy catching and throwing!

Cellular Rubber cover is durable yet soft and cushiony. The Japanese wound bladder provides greater air and shape retention. Multi-panel design with dimpled cover.

17208 Size 1 Elementary/Middle School.....	\$17.99	SALE	\$14.97 ea.
17209 Size 2 High School.....	17.99	SALE	14.97 ea.

GROUP GAMES



ZONE Bounder BALL

A fast paced rebounding game with a twist. Teams score by throwing a 6" diameter ball into the center pocket surrounded by a rebounding panel. Missed shots bounce back into place helping to improve reaction times. Vary gameplay with rules similar to Ultimate Frisbee or Tchoukball. Full set includes 2 adjustable angle, heavy-duty steel goals and (3) size 1 game balls – POWRGRIP Tchoukball, ZONE Tchoukball, and RUFFSKIN Foam Handball. Frame measures 40"L x 39.5"W.
X54291 Bounder BALL Full Set..... **\$349.99 set**
X54289 Goal Pair Only..... **319.99 set**



Zoner Game Set
Fast moving team game!

This non contact sport is easy to learn, fun to play and makes for a great aerobic workout. The unique A-framed 41.5"L x 30"W x 37 1/2"H goal has scoring pockets on one side. Place the goal at the end of any rectangle sized playing area and teams score points by throwing ball into the scoring pocket. Teams advance the ball by dribbling and passing it to team members. Includes 2 goals, two 6" inflatable balls and game instructions.
X16397 **\$249.99 set**



BowNet
Team Handball Goal
Designed with non-marking rubber feet to protect floors!

Set up a game wherever you might need it with this portable, official size goal. Features a nylon net, ground frame, poles and a carry bag. Designed for either indoor or outdoor use. Measures 2m x 3m and weighs 25 lbs. Includes carry bag. Sets up in 2 minutes with 2 people.
16433 **\$399.99 ea.**



ZONE POWRPRO
Series Handball/Soccer Goal

Premium steel framed goal can be used for multiple sports. POWRPRO goals are extremely durable, high-quality goals that allow you to maximize your PE budget and assemble easily. The 1.25" diameter steel frame is great indoors or outside. Made with reinforced PVC corners joints and twist-tight connectors. Includes 4" braided net. Measures 6'L x 51"H x 36"D.
54282 Soccer Goal, Braided 4" Mesh Net Only..... **\$110.99 SALE \$89.97 ea.**

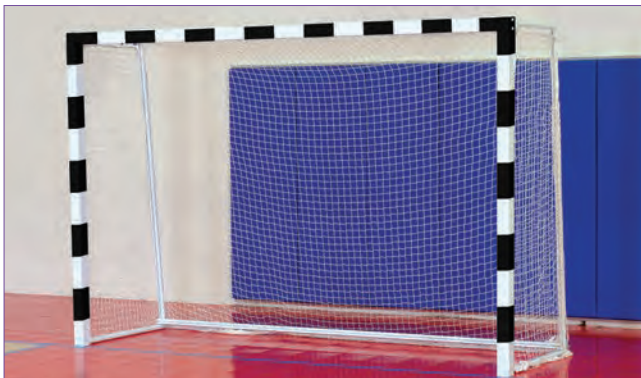

Bison® Official Team Handball Goal
Features fast and easy QwikTrack net attachment.

Constructed of 3" square aluminum extrusion tubing with anti-skid floor protectors and portable ballast bags and net. Nets not returnable once opened. Measures official size 2m x 3m. Goals weigh 88 lbs. each. Ships by truck.
T17188 **\$2,099.99 pr.**



eUROPA 360 Team Handball
Top grade team handball!

Super grip, 32 panel, hand stitched composite cover. Multilayer Super Bladder technology. Size 2.
57008 **\$21.99 ea.**

GROUP GAMES



ZONE Adjustable Height Round Base Goal

Customizable goal available in 40" full-size and 20" compact versions!

Both models come with a closed bottom net. Use as a large shooting goal or for 360° soccer/ floor hockey. Place sideways for use as a traditional goal. Adjustable heights: 28", 30", 35" and 40".

Additional options include:

- V2 Open Bottom Net (40" goal only) – Allows goals to be scored from the side without rebounding back. Create obstacle courses when tipped on its side allowing students to pass through the goal.
- Round Base Goal Ring Covers – Simple nylon fabric covers stretch over the goals top ring to convert them into unique colored goals. Set of 6 colors. Two sizes: 20" dia or 40" dia.

17190 40" Adjustable Goal	\$129.99 ea.
17278 20" Adjustable Goal	99.99 ea.
18250 SET OF 6 40" Ring Covers	59.99 set
17279 SET OF 6 20" Ring Covers	39.99 set
17189 40" V2 Open Net only	49.99 ea.



COVER AVAILABLE IN 6 COLORS



USE V2 OPEN NET FOR SOCCER OR FLOOR HOCKEY

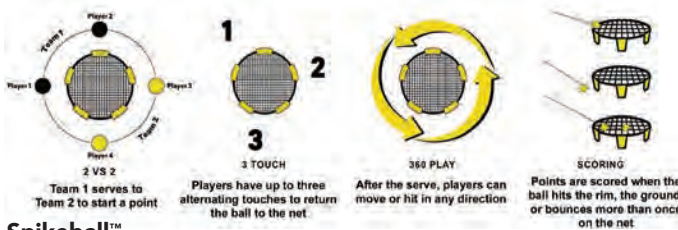

Spikeball™

Spikeball is played 2 on 2 with rules similar to volleyball.

Intense and fast! A taut net is placed at ankle level between a pair of two-player teams. Players smack the air filled, rubbery ball down on the net so it ricochets up at their opponents. They have up to three hits between them (just like volleyball) to control it and bounce it back to the other team. When they miss, the other team scores. First team to 21 wins.

10575 Original Kit Includes: net, 3 balls and carry bag.....	\$59.00 ea.
10583 Pro Kit includes: net, 2 balls, official serving line, ball pump and gauge and backpack.....	99.00 ea.
10584 Rookie Kit includes: XL net, 1 XL ball rule book and carry bag.....	60.00 ea.
10597 Replacement Ball 2 pack (for Original Kit only)	9.99 set



ORIGINAL KIT

- 36" net
- 3; 3.5" balls
- Carry Bag



OFFICIAL SET OF USA SPIKEBALL TOURNAMENTS

PRO KIT

- 36" net
- 2; 3.5" Proballs
- Backpack
- Serving Line
- Ball Pump and Gauge



ROOKIE KIT

- XL 45" net
- 6.5" ball
- Rule Book
- Carry Bag

GROUP GAMES



Sabakiball® Games Sets

Total movement, total involvement!

Pass the ball within 3 seconds to their teammate, 3 passes must be completed before throwing at the pin. If a ball is thrown out of play, another is immediately put in play so there's no stoppage of time- the game continues! The 6" BakiBall® is easy to grip and made with a soft cloth cover and rubber bladder. The BakiPin® measures 6" L x 6" W x 22" H, is made from foam with a nylon cover and a sandbag base to remain upright. PE Set includes 2 47" W x 32" H vinyl hanging backboards and the PRO Set includes 2 free standing 47" W x 32" H PVC backboards that are foldable and have a handle for ease of portability.

VIDEO ONLINE

- X16124 PE Set: 9 balls, 2 pins & 2 vinyl backboards \$329.99 set
- X16125 PRO Set: 9 balls, 2 pins & 2 freestanding backboards 699.99 set
- 17369 5" Replacement Ball - Red/Black 13.99 ea

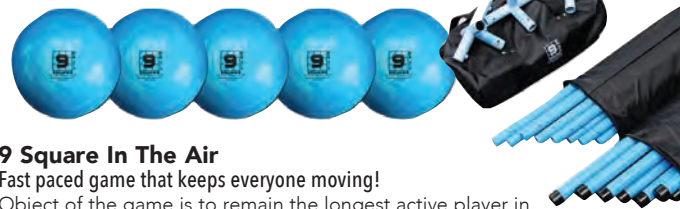

9 Square In The Air

Fast paced game that keeps everyone moving!

Object of the game is to remain the longest active player in the squares. The center square serves the ball by striking it into any other square. If the ball goes out of bounds the last player to touch it is out, leaves their square and the remaining players move up a square. A new player enters the square for the last position. The fast paced game means nobody stays out for long. Constructed from PVC pipe, Set includes all of the PVC pipes, legs, metal connectors, assembly tools, game ball, carry bags and activity guide.

- X16392 Measures 18' x 18', adjusts from 5' to 7' heights..... \$899.99 set
- 18257 5 Ball Replacement Pack 32.99 pk.



RampShot™

A 4 player game with constant movement!

Develop hand eye coordination, throwing skills, strategy and teamwork. Players attempt to throw ball into the goal while their partner attempts to catch any rebound for points. But watch out! The stealer will try to catch the ball as well in order to win an extra toss! First team to 15 points wins. Includes 2 ramps, 2 nets, 4 balls and instructions.

- X16385 \$69.99 set



TriGoal™ Net

The Original Goal For Circular Soccer!

Made from pop wire and nylon technology, the TriGoal™ simply twists and folds for easy set up and storage. Unique top zipper feature quickly aligns the net and reinforces stability. Includes 6 steel pegs to use on grass and 3 rubber weights for indoor or turf play. The 3 sided net measures 48" W x 39" H. Includes three 8" diameter starting spots and twelve 8" boundary spots. Includes carry bag and directions to play Circular Soccer. Use as a shooting target- get more players involved in a smaller space. Activity sheet included for alternative games.

- 16580 \$109.99 SALE \$89.97 ea.



TOSS GAMES



Class Pack Rubber Horseshoe Set

Rubber horseshoe is easy and safe to throw!

The 8 oz., 6.5"H x 5.5"W flexible shoe is firm yet not brittle and has realistic horseshoe markings, and weighs 8 ounces. Modify the rules that every player's horseshoe that touches the pad gets a point and ringers are three. The Class Pack Set includes 36 horseshoes and 6 stakes color coded for six teams and a storage bag. The Single Set includes one Indoor/outdoor plastic 9.5" high stake with 10" diameter base, and 6 horseshoes; one of each color.

- 15407 SET OF 6 Single Set-1 base, 6 shoes \$24.99 SALE \$19.97 set
- 15493 SET OF 12 Double Set-2 bases, 12 shoes 49.90 SALE 37.97 set
- 66343 36 Player Class Pack: 36 shoes (6 each color), 6 stakes & storage bag 154.50 SALE 112.97 set

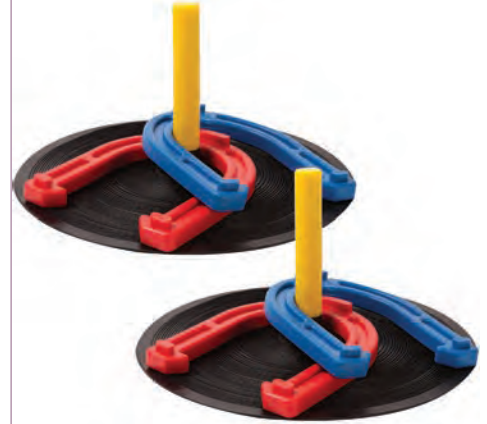

Rubber Horseshoe Sets

Use indoors or out!

A safe, affordable and extremely popular game. The set has two rubber mats with stake for indoor play and two plastic stakes for outdoors. Also includes 4 rubber horseshoes.

- 15054 \$17.99 set

The Official Bagger Game

Raise your bean bag toss game to a new level!

Boards face each other with players standing and tossing bean bags from the side. Players toss the bean bags onto the board or in the hole for points. Boards are made from sturdy polyethylene with vinyl surfaces to withstand heavy use. The set comes with 2 boards, 8 twill bean bags, instructions, rules, distance regulator and wall bracket for mounting. Boards nest together for compact carrying and storage.

Measures 20"W x 34"L, weighs 20 lbs.

- X15579 Official Bagger Game \$109.99 SALE \$99.97 set
- 15593 Replacement Bean Bags-Set of 8; 4 Red 4 Blue 19.99 set



Recreational Horseshoe Set

Ideal for parks and organizations.

Official size, weight and dimensions. Set includes 4 official 2.5 lb. steel shoes, 2 solid 24" stakes, official rule book and court layout instructions. Stores away in its own hard plastic carrying case. For ages 12+.

- X15056 \$44.99 set

Junior Bean Bag Toss Set

Smaller for limited space!

Boards measure 2'L x 1'W and are made from MDF with vinyl surface. Includes 2 boards and six 5" x 5" bean bags and game rules. Boards Velcro® together to hold bags with carry handles.

- 16805 \$39.99 set



3 Hole Bean Bag Toss

3 chances to score on the board!

Lightweight composite construction with mesh pockets, score keeper on each board and folding design for transport and storage. Includes 4" bean bags- 3 blue and 3 black and carry case. Measures 18"L x 24"W.

- 16160 \$49.99 set

TOSS GAMES

NEW

Shield® Ball Slam®

Easy setup for indoor or outdoor play. Teams compete with a 5" playground ball and two scoring containers. Helps develop throwing, ball control and eye-hand coordination. Easy and fun for all ages. Includes 2 goals, 5" rubber playground ball and activity guide, which includes 8 Ball Slam® games.
17403.....\$54.99 set



Kan Jam Game

Encourages exercise and improved coordination! Partners toss the disk toward their goal and score points by hitting the goal or deflecting the disc in. Goals are made of plastic and fold flat. Game set: Includes 2 goals, 1 official 11" disc and instructions. School Set- Includes 10 goals, 5 discs & instructions. Goals measure 11.4"L x 9.8"W x 20.5"H.
16171 Game Set..... \$39.99 set
16172 School Set..... 169.99 set

Disc Slam™

Score extra points through the front slot!

Players score points by throwing their disc through the target slot or having their partner tip the disc into the open top. Targets are made of nylon and measure 19" high with a 15" diameter. Disc Slam™ includes two 8.5" discs, two collapsible targets and storage bag.
16040.....\$29.99 set
66548 Class Pack- 24 players..... 164.99 set



ZONE

3-Color Foam Ring Set

Vibrant flying rings make toss and catch games fun! Players toss rings and try to get their chosen color closest to a stake, or teams earn points by catching the rings on the color assigned. Made of soft durable foam. Includes 3 - 13.75" rings.
17229 Set of 3..... \$21.99 **SALE \$16.97 set**



Deck Rings

Ideal for tossing, catching and ring toss games. The Jumbo Deck Rings are 14" in diameter and made with a 2" thick urethane foam core with heavy duty vinyl covering. The Rubber Deck Tennis Rings are made of a 1.25" thick light sponge rubber with a 6.5" diameter. Both ring styles are made to withstand heavy everyday use and are sold in a set of 6.
15408 SET OF 6 14" Jumbo Deck Rings w/activity sheet.....\$48.99 **SALE \$36.97 set**
15484 SET OF 6 6.5" Rubber Deck Tennis Rings.....16.99 **SALE 13.97 set**



Fold-N-Go® Washer Toss

Great for field day or tossing stations! Ideal for developing accuracy, motor skills and integrating math in your classes. Includes two 12" x 12" octagon targets and six 2" diameter steel washers. Targets pop up for compact storage with the included carry bag.
15960.....\$26.99 **SALE \$23.97 set**



Foam Ring Toss Set

Safest ring toss game yet! Can be played indoors or out! Constructed of sturdy PVC plastic covered in foam. Includes 4 high density coated foam rings (2-green 2-black). Comes with carry case. Dimensions: 7"H x 9"W.
15549..... \$15.99 set



Ring Toss Set

An extremely popular game! The X-shaped five peg wooden toss game with four flexi-rubber rings will give kids a greater chance of success. 8"H x 16"W.
15074.....\$19.99 set

TOSS GAMES



Indoor/Outdoor Soft Bocce Ball Packs

Get the whole class involved!

Sets include pliable 3.5" diameter balls weighing 1.3 lbs. with soft, thick rubbery PVC covers that deadens when tossed on a gym floor, and 2.75" vinyl jacks. Balls do not damage floors and can be used outdoors. Choose the 4 player pack or get the whole class involved with our team packs.



ZONE 8 Ball Basic Pack

A classic 4 player game!

Includes 8 balls- 2 green, 2 red, 2 yellow and 2 blue, 1 jack and carry bag.

66317 \$94.50 **SALE \$49.97 pk.**



ZONE 32 Ball 2 Team Pack

For up to 32 players!

Includes 16 green balls, 16 yellow balls, 2 jacks and two yellow storage buckets.

66315 \$382.99 **SALE \$199.97 pk.**



ZONE 32 Ball 4 Team Pack

For up to 32 players!

Includes 8 green, 8 red, 8 yellow and 8 blue, 2 jacks and two yellow storage buckets.

66316 \$382.99 **SALE \$199.97 pk.**



Franklin® Recreational Bocce Set

A durable entry level set at a great price!

Includes: eight 3.5" (90mm) composite molded balls (2 red, 2 green, 2 blue and 2 yellow), one 1.5" (40mm) jack, rules and carry bag.

⚠ CHOKING HAZARD (3) - CONTAINS A SMALL BALL. Not for under 3 yrs.*

X15543 \$26.99 **SALE \$23.97 set**



Franklin® Professional Bocce Set

Excellent for institutional play!

Includes: 8 - approx. size 4" (100mm) all-weather resin balls (2 each of red, yellow, blue & green), 1 - 2" (50mm) white jack, and deluxe carry bag.

⚠ CHOKING HAZARD (3) - CONTAINS A SMALL BALL. Not for under 3 yrs.*

15524 \$66.99 set



NEW

Franklin® Soft Bocce Set

Soft low-impact balls are great for indoor play.

Includes: (8) 90mm all-weather soft PVC balls, (1) 40mm jack, rules and carry bag. Indoor/outdoor play. ⚠ CHOKING HAZARD (3) - CONTAINS A SMALL BALL. Not for under 3 yrs.*

17404 \$40.99 set

* Full CHOKING HAZARD descriptions on page 355.

TEAM BUILDING



NEW
Select Series Bocce Set

Designed for competitive play.

Includes: Top quality 3.9" (107mm) resin balls (4 red, 4 blue), 1.6" (60 mm) jack, rules and deluxe carry bag. **⚠ CHOKING HAZARD (3) - CONTAINS A SMALL BALL.** Not for under 3 yrs.*

15547 \$69.99 set



ZONE Super Flings

Use individually, with partners or teams!

Bright colors are easy to see, the 32" nylon tail is easy to catch and the nylon covered soft ball is easy to throw! Ideal for young learners!

16103 SET OF 6 \$41.99 SALE \$34.97 set



ZONE Indoor Bocce Set

For up to 6 players!

Less rolling makes this set perfect for playing inside! Made with a durable neoprene cover. Includes: 12 balls (2 of each color), 1 jack, and carry bag. **⚠ CHOKING HAZARD (3) - CONTAINS A SMALL BALL.** Not for under 3 yrs.*

17240 \$59.99 SALE \$48.97 set



Tail Ball

A great tossing challenge!

Swing, throw and catch by the 3' tail or the 2.25" ball! The ball has a synthetic cover with a soft filling and is sewn into the multi-colored nylon sock.

11056 \$4.99 ea.



Bean Bag Bocce Class Pack

For up to 48 players!

Get the whole class involved with this set of 48 bean bags and 12 bean bag jacks. Pack includes four dozen 5" nylon bean bags and one dozen 3" vinyl bean bags. Divide class by colors and use the 3" bags as your targets. Use extra 3" bean bags for dual target games. Includes mesh tote bag for storage.

66105 \$65.99 pk.



ZONE Team Tossers Class Pack

Race to score points!

Simply divide the class into 6 color groups, have relay tosses or add locomotor skills, exercises or an obstacle course into the tossing fun! Set includes 48 canvas 4" bean bags in 6 colors and 6 targets with adjustable 16" steel coated frames. **⚠ CHOKING HAZARD (3) - CONTAINS A SMALL BALL.** Not for under 3 yrs.*

66527 \$226.90 SALE \$179.97 set

*Full CHOKING HAZARD descriptions on page 355.

NEW

Golf Bocce

Practice your chipping skills while competing in a fun bocce themed game.

Played with rules similar to bocce ball, players take turns chipping their larger fleece balls towards the smaller Short Flyte ball (or jack). Play continues until one team reaches a score of 11. Includes: Set of 6 ZONE 7 Irons, set of 2 sets of 6, 3" premium fleece balls and set of 4, Short Flyte practice golf balls.



66793 \$54.99 set

TEAM BUILDING



SOFT FOAM TOSSING BOLOS FOR INDOOR OR OUTDOOR PLAY!

ZONE Premium Ladder Golf Set

A fun toss game with soft foam bolos, play indoor or out! Easy to set up and play. Goals are constructed of premium 1" dia. heavy duty PVC for maximum durability. Bolos are made of durable all-weather foam. Includes 2 goals and 6 bolos (3 yellow and 3 orange). Goals measure 27" L x 24" W x 29" H.

16200 \$59.99 **SALE \$46.97 set**
 17402 6 pk Replacement Bolos (3 Yellow & 3 Orange) 16.99 set

Ladder Ball Game Set

A soft alternative! Tossing bolos are made from soft, weighted polyurethane sponge for safe play. Frames are made from 1" diameter plastic and assemble easy. Earn points by throwing bolos at different color scoring rungs. Frames measure 39" H x 22" W with deep bases for stability. Set includes 2 frames and 6 colored tossing bolos.

X15584 \$33.99 set



Outdoor Toss Class Pack

Create stations for up to 32 players! Ideal for PE toss units, rainy day activities, field day and more!

- Pack includes:
- 1 set 16040 Disc Slam®
 - 1 set 15960 Fold and Go® Washer Toss
 - 1 set X15584 Ladder Ball Game
 - 1 set 66317 8 Ball Soft Bocce Ball pack
 - 1 set 15500 Hi Lo Scoop game Set of 6
 - 1 set X15579 Baggio Game

X66468 \$369.99 **SALE \$279.97 pk.**



Katch-A-Basket™

Use for dozens of catch, toss, balance and cooperative games! These 5" diameter baskets have 5" long removable handles. Take off handles and use baskets for stacking, ground targets or for easy storage. Includes 6 free scooter arms that snap onto square handled scooters to create rolling targets. Set includes 6 colored baskets, 6 handles, 6 scooter arms and activity guide.

15894 \$51.99 set



Catch-A Ball

Flip the ball in the air and try to catch it in the cup! Sounds simple enough and its even easier with this oversized plastic cup. All plastic, it includes a baseball size whiffle ball attached to a sturdy nylon cord that loops around the handle. Remove the ball and cord and play bounce catch with tennis balls, play relay races with yarn balls, balance larger balls on them, the ideas are all in the cup. Sold in set of 6.

15554 SET OF 6 \$19.99 **SALE \$14.97 set**

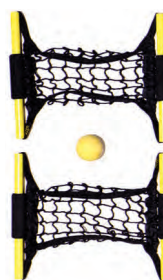

Trapp Ball

An exciting game of catch. Trapp Ball has a net-like mitt that will launch a foam ball over 50 feet and will also catch the ball when launched back to you. Also can be used as a water balloon launcher if desired. Includes 2 net launchers and one foam ball.

15512 \$19.99 set

TOSS GAMES



ZONE Scoop Ball 36 Player Class Pack

Get everyone involved!

Create color teams, use colors as point values and more! Set includes 36 scoops- 3 pairs of each color and 18 balls- 3 of each color and 2 mesh storage bags.

66750.....\$103.70 **SALE \$79.97 pk.**



FOR USE ON LEFT OR RIGHT HAND

ZONE Safe Catch Gloves

For left and right handed players!

These confidence building gloves have hook and loop palms and patches that catch the ball easily for younger players. Gloves are made from flexible neoprene. Includes 6 gloves and 6 soft soft balls.

16195 SET OF 6.....\$64.99 **SALE \$49.97 set**



ZONE Hi-Lo Scoop Game

An old time game that still has no substitute for eye-hand coordination.

Now in a set of six colors to identify teams. Each game consists of 2 scoops and 1-12" plastic ball. Sold as a set of 6; 2 scoops and 1 ball one of each color.

15500 SET OF 6.....\$64.99 **SALE \$49.97 set**



ZONE Catch Pads

Soft and flexible!

Adjustable hand straps with hook and loop closure. Made from a durable neoprene. Includes 6 catch pads and 6 soft fuzzy balls.

16196 SET OF 6.....\$38.99 **SALE \$29.97 set**



ZONE Ball Launcher

Send the ball high in the air!

Stomp and catch with this molded plastic launcher. Has a channel for the ball to roll down. Includes 3" vinyl ball. Measures 24"L x 4"W.

16386.....\$15.99 ea.



Supercatch™

Improved and more durable!

You throw the tennis-like ball with your strongest arm and wear the catch pad on your catching hand. Excellent for success orientated activities as well as hand-eye coordination.

15481 Set-2 Paddles & Ball.....\$6.99 set



Molded Rocket Launch™

Roll, stomp and catch!

Holds balls from 2"-7" in diameter. Easily launches items such as bean bags or other non-rolling items. Made from injection molded plastic. Measures 24"L x 5"W.

15485.....\$23.99 ea.

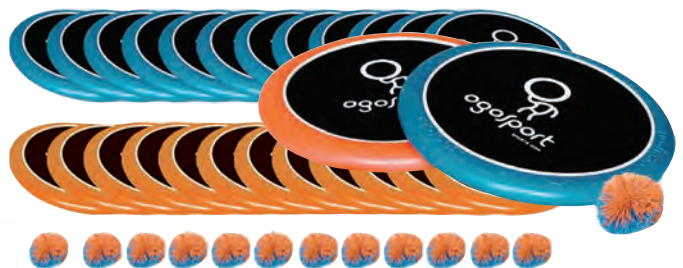

OgoSport™ SuperSports Disk

Catch and throw balls up to 150 feet!

Extremely versatile- can be used as a flying disc as well! Use with all types of balls for a variety of catch play- even water balloons! Use as a paddle for net games or create a bouncy baseball game! SuperSports Disks are made with a dense coated foam ring with attached reinforced fine mesh catching surface. Available in 2 sizes: 12" or 15" diameter.

16073 15" SuperSports Disk Set - 2 disks and 1 ball.....\$29.99 set

66417 15" SuperSports Disk Class Pack- 24 disks & 12 balls.....\$349.99 pk.

GAME ACTIVITIES



Franklin® Six Player Croquet Set

Well made for serious play.

Set includes: Six – 7" x 1.8" wooden mallet heads with caps and 26" long chestnut finished wood shaft, 6 – 2.75" all weather molded balls, 2 – 18" long painted wood stakes, 9 all-weather coated bent wire wickets, and carry bag.

15183 \$59.99 set



Franklin® Intermediate Croquet Set

Makes a great starter set!

Includes: 2 – 26" and 2 – 24" mallets with 7" x 1.8" wooden heads with caps and chestnut finished wood shafts, 4 – 2.75" all weather molded balls, 2 – 16" long painted wood stakes, 9 all-weather coated bent wire wickets, and carry bag. Choose a single or double set.

15199 Single Set (4 mallets, 4 balls, 2 stakes, 9 wickets) \$37.99 set

66768 Double Set (8 mallets, 8 balls, 4 stakes, 18 wickets) \$4.99 set



Kwik Cricket Set

Great for learning the basics of cricket!

Made from high impact plastic with an easy to assemble 28" high wicket, a 32" long bat and a 2.75" vinyl cricket softball. Includes sturdy carry bag.

15981 \$64.99 set

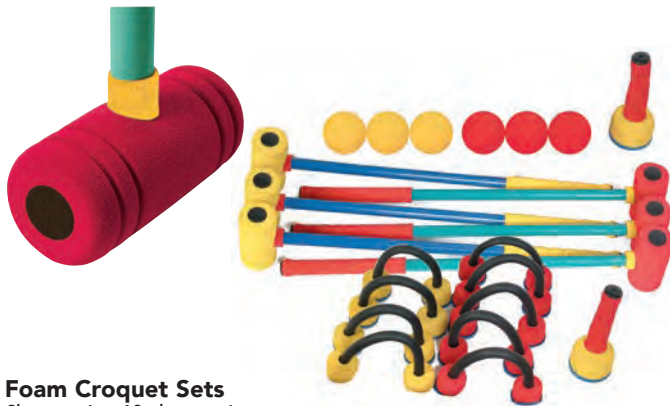

Foam Croquet Sets

Choose a 6 or 18 player set!

This foam alternative is made with such dense foam, picking is nearly impossible. Mallets are 27" long with foam covered head and grip with a firm plastic shaft; the wickets have a foam covered reinforced base with tubing crosspiece; the stakes are all reinforced foam and 6.5" high. Wickets and stakes have a smooth plastic bottom for stable placement indoors. Also includes super dense, no bounce 2.5" foam balls and carry bag.

6 Player Foam Croquet Class Pack

Includes 6 mallets, 9 wickets, 6 balls, 2 point stakes and a carry bag.

15174 \$74.99 **SALE \$59.97 set**

12 Player Foam Croquet Class Pack

Includes 12 mallets, 18 wickets, 12 balls, 4 point stakes and 2 carry bags.

66549 \$149.90 **SALE \$98.97 set**



NEW

4FUN Wicked Kick Croquet

Have big fun with this giant version of the traditional game.

In this version, kids guide giant 14" balls through a course of wickets using only their legs and feet. This high energy game can be made more or less difficult by how the wickets are arranged. Set Includes (2) 14" high density PVC balls, (7) powder coated wickets, 2 poles and 1 hand pump.

17405 \$31.99 set

GROUP GAMES

Shuffleboard

Shuffleboard is a game all ages can play.

It not only teaches hand/eye coordination it also enhances addition/subtraction skills. Can be played individually or as a team. The complete set includes 4 lightweight 68" L aluminum cues and eight 6" discs (4 yellow/ 4 black). Court not included.



- 15064 Complete set.....\$82.99 set **SALE \$69.97 set**
- 15063 Rep. Discs-Set of 8 (4 yellow, 4 black)49.99 set



NEW

Shuffle Zone® Game Carpet

Classic shuffleboard game on a colorful carpet court.

An active game, which contains elements of strategy, shuffleboard is great for students of all ages. Set includes a high quality indoor/outdoor carpet, two wooden cues and ten wooden pucks. Cues: approx. 48"L. Carpet Court: approx. 2¼'W x 12'L.

- 17407.....\$109.99 set



EXCELLENT FOR OUTDOOR & INDOOR USE!



Beginners Shuffleboard Set with Court

For indoor or outdoor use.

The court is 15' long and made of special plastic with a memory. It always lays flat and water dampness won't hurt it. Set includes the court, 4 cues, 4 yellow discs, 4 black discs and playing rules.

- 15070.....\$89.99 **SALE \$79.97 set**

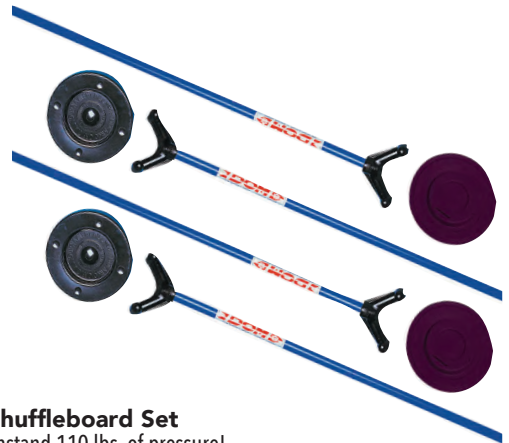

Dom® Shuffleboard Set

Shafts withstand 110 lbs. of pressure!

The 67" long shafts are made of fiberglass wrapped in polyester for added strength and durability. One piece molded tips have rounded edges for ease of play. Set includes 4 sticks, 8- 6" diameter discs (4 maroon, 4 black), and playing rules.

- X15192.....\$164.99 set



Scatter Ball

A new twist to dodgeball!

A 6 player game in which a numbered color dot Scramball is rolled, the player whose colored wristband matches then picks up the Scramball and attempts to throw it at the other players as they "scatter". If they are struck, they must give up a wristband but if they catch the Scramball, the person who was throwing must give up a wristband. The person who collects the most wristbands is the winner. Set contains 18 colored wristbands, 1 colored foam 4.5" Scramball and instruction sheet.

- 15589.....\$37.99 set

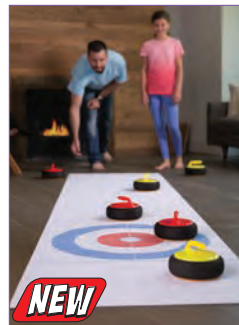

NEW

Air Zone™ Electronic Curling Game

Bring the popular winter sport of curling indoors.

Curling is a game of coordination and strategy that is excellent for team building. Players glide the 6 included stones toward the target, and the one closest to the bullseye scores a point. Similar to air hockey, these curling stones glide on a bed of air. They are made of firm plastic and feature a foam bumper for protection. Durable mat is 11.5"L x 2.5'W. Each stone requires 4 AA batteries (not included).

- 17406.....\$99.99 set





Angleball Full-Court Set

Designed for inclusion and to enhance, strengt, speed and precision!

Two teams attempt to knock off the opponent's target ball with their Angleball. Includes everything needed to set up for a fun period of gameplay: 2 water-base indoor/outdoor standards, 2 target balls, 2 Angleballs, 32" carry bag, rules & setup guide. Target ball: 10"D; Angleball: 4"D; Adjustable standards: 4', 6', 8' and 10'. 15lbs (unfilled). 1 year full warranty.

X17304 \$468.99 set

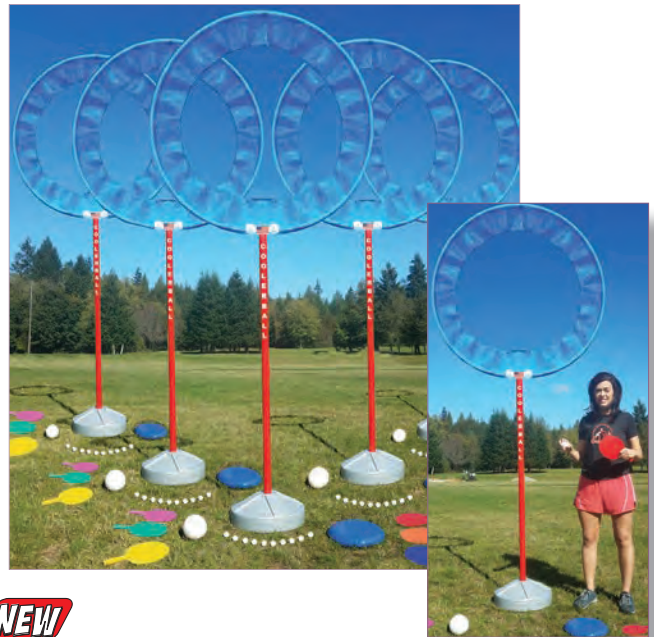

NEW

Coolerball & Disc™ Sets

The innovative, adjustable rings and accessories allow for an unlimited number of group games.

From the creators of Angleball™, in CoolerBall™, players paddle the ball through the ring with 3 touches allowed per side.

CoolerDisc™ is played 360° around the ring. One point is scored when a player sends the disc through the ring, 2 points if a teammate catches it on the other side, and a bonus point from the outer circle. Play Ring-Pong™ and more! Ring adjusts from 30" – 48" D. Pole adjusts from 24" – 72" H. Includes: soft foam and firm plastic 2" balls, 10" discs, 13"L x 8"W plastic paddles, throwballs and instructions for dozens of sport and game varieties. Single set is for 6 – 12 players. Class Pack accommodates up to 30 players.

17408 Single Set \$249.99 set

Single Set – 6 paddles, 20 balls (6 soft, 14 plastic), 1 each – goal w/ fillable base, disc, throwball & carry bag

17409 Class Pack 998.99 pk.

Class Pack – 30 paddles, 100 balls (30 soft, 70 plastic), 5 each – goals w/ fillable bases, discs, throwballs & carry bags



NEW

CROSSNET

Four square meets volleyball.

Crossnet is the first official four-way volleyball game. It combines traditional four square and volleyball rules in a competitive game. Games play to 11 points, with the winner by 2 points. Quickly adjust from four-way competition to traditional volleyball short court play or three-way skills training. The four-way net is adjustable for children's, women's, and men's outdoor volleyball heights. Set up in grass or sand. Each Crossnet includes a convenient travel backpack, a volleyball and a ball inflator pump.

33628 \$144.99 ea.



NEW

Franklin® Foot Golf

Interlocking design assembles in seconds.

Foot golf combines the skills of soccer and golf together to form a fun and exciting new game. Play indoors or outside foot golf is perfect for recess, field day, and recreation. The set includes: (3) 20" target holes with flags, (1) size 1 rotationally molded soccer ball, inflation pump with needle, and instructions.

17410 \$34.99 set



NEW IMPROVED DESIGN!



Cannon Launcher

Stomp on the launcher and watch the ball fly with great velocity!
 Made from heavy duty vinyl, the launcher works with most 3" foam balls.
 Launchers measure 5"H x 9.5"W. Set includes 6 launchers and 36 foam balls.
16178 SET OF 6 **\$159.99 set**
17414 Single Canon Launcher **32.99 ea.**



NEW

Ringmaster™

A fast paced game of scoring and evasion.
 Players toss and run the rope ring around the playing field attempting to get it to a Ringmaster in 1 of 3 designated squares who must catch the ring on his catching stick. Each square earns different points. First team to 30 or more becomes Master of The Ring. Modify the rules to vary gameplay. Each set includes: 8 foam catching sticks (4 red/4 blue), 1 rope ring and instructions. Squares may be created with poly spots or cones (not included).
17411 **\$104.99 set**

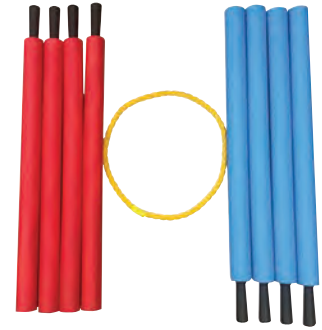

WAKA® Kickball Kits

Enough bases and balls to set up two games!
 Sets includes 4 Official WAKA® kickballs, two sets of rubber bases with pitching rubbers (43253), official WAKA® rules and a durable canvas bottom mesh carry bag (36121).
66323 10" Ball Kit **\$85.90 SALE \$76.97 kit**
66566 8.5" Ball Kit **77.99 SALE 69.97 kit**



BENDABLE NOODLE CONNECTORS

Foam Noodles & Noodle Connectors

Hundreds of uses outside of the pool!
 Create safe obstacle courses, make foam hurdles, target circles or cut them up and use as pins or taggers. Makes a great fitness item as well. Connectors are bendable foam inserts that join multiple noodles into various shapes, targets, goals, crossbars and more! Choose from two sizes of connector.
32363 Noodle Connectors 6" - Set of 12 **\$31.99 SALE \$24.97 set**
32362 Noodle Connectors 10" - Set of 12 **39.99 SALE 29.97 set**
X58021 Foam Noodles - Box of 12, Assorted Colors, 58"L x 2.75"D **75.99 box**



Takraw Ball

Ideal for kick volleyball!
 Play over a net with your feet instead of your hands! Plastic, hand-woven design for lots of rebound and ease of control.
 145 grams; 5.25" diameter.
15019 **\$27.99 ea.**

Guate Foot Bags

Knitted foot bag.
 Slightly larger than the original Hacky Sack, makes it easier to play with. A tightly woven knitted foot bag that is easy to break-in and extremely durable. Great buy!
15550 **\$3.99 ea.**



Dart Ball

No one can resist playing this game.
 A 25" nylon inflatable target with velcro patches strategically sewn on target for tennis-like ball to stick to when contact is made. Comes complete with 3 balls, one inflatable air chamber, and straps to hold on to or hang on a wall.
15526 **\$24.99 set**



GROUP GAMES



TeamWebs™

Team building made affordable!

Communication, maneuvering and spacing gets your team in position around the pick up object. Move items from one spot to another, challenge groups to see how many items they can pick up and move in a timed event! Includes basket, 10 nylon support ropes with Velcro® connectors and activity guide.

15883.....\$49.99 ea.



Co-Op-A-Mat

Great team building activity!

Teach your students cooperation, communication and team work with this large durable vinyl mat. Measures approximately 30'L x 39"W.

16140.....\$79.97 **SALE \$79.97 ea.**



Team Bucket Challenge

Accommodates 8 to 24 players!

Create meaningful lessons such as saving the world from drought or food shortages or just have fun with these bucket exchange games! Includes 2 rubber rings with 6 ropes with handles to carry the buckets, 2 blue solid bottom buckets, 2 green buckets with holes in the bottom and instructions for 4 team building games.

16803.....\$49.99 pk.



Team Transport Challenge

Work together to carefully transport the object!

Two sided platform has an easy side with a depression that helps hold the ball in place, or a harder flat side. Switch out the ball with other sized balls or objects, like a bowling pin to add variety. Each set contains a 6.5" platform with 6- 34" long ropes with foam handles and a 2.25" diameter ball. Includes a blue set, a green set and an activity guide.

16804.....\$49.99 pk.



Bucket Ball Transfer

Stop the spread of radioactivity!

Players must transfer and dump the nuclear particles, which in this case are brightly colored balls, into the bucket. Includes ten 5' ropes with handles, a plastic mesh bucket, balls, dumping bucket and activity guide.

15482.....\$99.99 **SALE \$86.97 set**



The RunningMan™

Play one on one, in pairs or in teams!

Watch as he runs from one end to the other or see who can roll up the string to reach The Running™ man first! Excellent workout for the wrists, forearms and other muscle groups. Each Running Man™ is made with two 17" long handles, a 16' long cord and the 12"L x 10"W plastic molded Running Man™. Sold in a six color set of one of each to involve up to 24 players. Set includes: 6 sets of the Running Man™, one of each color, instructions and activity guide.

15470 **SET OF 6**.....\$119.99 **SALE \$109.97 set**

GROUP GAMES



Marble Maze™

Move the marble through the course avoiding obstacles and holes!

While holding their rope, players must tilt and angle the maze as the marble passes by. Set includes the maze base, 3 different inserts and 5 movable obstacles to continue to challenge players, 3 small and 3 large marbles, 6 handles and an activity guide. **⚠️ CHOKING HAZARD (5) - CONTAINS A MARBLE. Not for under 3 yrs.***
15803\$171.00 set



Ball Transfer Game

A great game for 30 players!

Teams of 5 work together to pick up a ball and move it from post to post. Includes weighted foam bases with posts measuring 7" H x 6.25"W, 2.75" foam balls and ball holders with cords. Set is sold as a set of 6 colors with 12 bases, 6 balls, and 6 ball holders with cords. For indoor or outdoor use.

16188 Set of 6.....\$119.99 set



TeamPoles™

Keep it steady or lose it all!

Move over, under and through obstacles to toss, load and unload objects from basket to basket. The 36" long poles are constructed of high impact plastic. Set includes 6 pairs of poles and 6 buckets in 6 colors. Includes activity guide with more than 24 challenges.

X15887\$129.99 **SALE \$119.97 set**



Catch & Balance Set

The challenges are endless!

Teamwork is a must as players work together to move objects from one location to another, perform relays or launch the ball off their catcher towards a target! Catchers have 24" long nylon web straps with a 13.5" diameter mesh and nylon catching area. Set includes six catchers, one of each color and 6" vinyl ball.

15804 SET OF 6.....\$61.97 **SALE \$61.97 set**



Team Building Pack

Our most popular basic pack!

Includes:

- 1 set 15406 Blindfold Color Set
- 1 set 15804 Catch & Balance Set
- 1 set 15864 Human Hoops
- 1 set 15201 Partner Straps
- 1 set 15474 Marble Run

⚠️ CHOKING HAZARD (5) - CONTAINS A MARBLE. Not for under 3 yrs.*

66720\$209.99 pk.



Marble Run

Great group challenge!

Work the marbles through the tubes without dropping! Adding to the challenge is the fact that once the marble is in the tube, players cannot see it. Vary your design- start with a straight line, change it to a circle or make a random pattern to complete. Set includes 8 sectional PVC tubes, 1 removable end cap, 2 plastic balls and carry bag. Activity guide included.

⚠️ CHOKING HAZARD (5) - CONTAINS A MARBLE. Not for under 3 yrs.*
15474\$49.99 set

* Full CHOKING HAZARD descriptions on page 355.

GROUP GAMES

ZONE ParaTossers™

Toss and fling foam balls, rubber chickens and more!
Create fast moving tossing games for partners or teams. Pass balls from chute to chute, use for oversized team relays, or play a wacky version of kickball! Parachutes measure 48" L x 32" W and are made from durable nylon with a 1" wide outer reinforced band and looped corners. Measures 48" L x 32" W. Set of 6.

16220 SET OF 6 \$54.99 SALE \$45.97 set

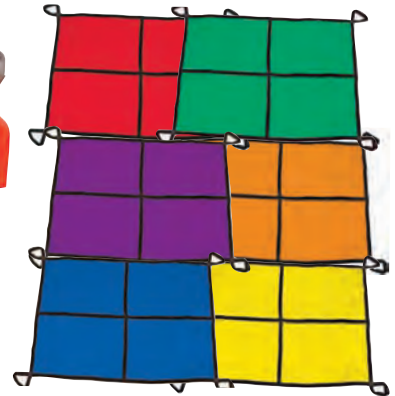

Team Connect-A-Chute™

Create multiple chute configurations!
Includes 6, 42" x 30" rectangular sections, 2 sections with holes and four corners sections measuring 30" x 30". Sections feature handles plus hook and loop fasteners to connect. Connect them together to create a runway to transfer objects from end to end. Connect a hole and corner to heighten the challenge or form a grid for a rectangular parachute. Includes activity guide.

16186 \$98.99 set



Blindfold Activity Kit

24 blindfolds, 60 plastic gym pins and carry bags.
Reinforce teamwork, communication and trust in your students. Sighted partners guide the blindfolded through a maze you create with the pins. Increase the challenge by adding obstacles, timing the event and adding scooters! Includes activity sheet.

66749 \$189.99 SALE \$129.97 kit



Egg Protector Game

Try to steal the eggs without getting caught!
A fast paced game where 1 player protects the eggs inside a roped area while other teams try to steal them. Team with most eggs wins! Maximum 6 teams. Includes 6 large 47.5" diameter rope circles, 36 foam eggs- 6 of each color.

16096 \$41.99 set



Partner Straps

Use for relays or any type of cooperative games.
These two-piece 12" straps create a 21" pull strap with a loop on each end for 2 people to use. They are made to make cooperation activities easier. The colored straps have velcro hook and loop fasteners on them that are designed to separate when too much pressure is created by the partners. Includes 15 two-piece straps per set, instruction guide and rules.

15201 \$41.99 set



Blindfold Color Set

With a no peek flap!
This nylon blindfold includes an adjustable head band with hook and loop closure to fit youth and adult sizes. Sold in a set of six. Activity sheet included.

15406 SET OF 6 \$13.99 SALE \$9.97 set

GROUP GAMES

Memory Maze™
Build cooperation, memory and problem solving skills! Square by square they move through the grid from start to finish, starting over each time an incorrect square is stepped on. Set includes an 8'10" nylon Memory Maze™ and a 10 card set of mazes for all skill levels.



X15847\$121.00 set



Escapades®
Over 300 games and activities!

An array of games representing team building, character education, physical challenges, problem solving and quiet, thought provoking activities. Designed for all ages, 2 or more players.



15426\$27.99 ea.

Brunton® Compass Class Packs

Course instruction for all ages! Class Packs include: Navigation Curriculum CD, a compass and map instructional DVD, instructor study guide, reproducible student workbooks, wall poster, overhead instructor compass and hard case with foam insert for compass storage. Available in packs of 12 or 24.



28522 12 Compass Class Pack\$249.99 pk.
28523 24 Compass Class Pack\$349.99 pk.



Navigating Physical Activity™

Hands on approach to learning compass and orienteering skills! Provides all the necessary tools needed for teaching students about compasses and orienteering. Set includes 12 high quality compasses, symbolic props for teaching messages, a 16.5"L x 11.5"W x 6.25"H storage tote and program guide with activities. Ages 8 and up.

16010\$174.99 SALE \$159.97 set



FREE LESSON PLANS
FOR PE TEACHERS!

We've created an online resource that features innovative lesson plans with great visual aids and equipment lists right at your finger tips.



Start planning at

www.pewithpalos.com



ZONE Plaque Buster Giant Foam Toothbrush

Brushing is a BIG deal!

Fight plaque on a larger scale with this extra durable 17" long foam toothbrush. It's sure to get kids excited about oral hygiene! Not only can this be used as a health education tool, it can also be used for relay games or classroom activities.

17226 Assorted colors\$9.99 ea.



Team Relay Puzzles

Set of 4 puzzles to keep everyone moving!

This 41 piece set includes a cat, frog, pig and rabbit made from heavy duty poly material and will not tear apart or break. Each puzzle measures 30" x 24". Includes activity sheet with game ideas.

X21070\$69.99 set

FIELD DAY

Field Day Pack

Create stations to keep over 50 kids moving!

Sack races, target tosses, kickball, relay races and more! This pack has everything you need! **CHOKING HAZARD (6) - BALLOON.** Not for under 8 yrs.*

Contents:

- 1 set 10424 RuffSKIN Dodgeball
- 6 ea. 13002 Potato Sacks
- 1 dz. X14014 30" No Kink Hoops
- 1 set 15062 Ultra Foam Batons
- 6 ea. 21029 18" Plastic Cones
- 1 set 11019 9" Colored Discs
- 12 ea. 21037 Orange Half Cones
- 1 ea. 10237 Grip-Rite Football
- 2 ea. 10002 WAKA Kickballs
- 1 set 43252 Thrown Down Rubber Bases
- 1 set 16799 Colored Egg & Spoon Set
- 1 ea. X20003 50' Tug Of War Rope
- 1 ea. 15529 Water Balloon Sling Shot
- 10 ea. 55050 1st Place Ribbons
- 10 ea. 55051 2nd Place Ribbons
- 10 ea. 55052 3rd Place Ribbons
- 2 ea. 36121 Canvas Bottom Mesh Bags
- 1 ea. 48102 Ultrak 310 Stopwatch

X66356 **\$369.97 SALE \$369.97 pk.**



Water Balloon Sling-Shot

Great fun for summer camps and YMCA's.

This involves team work, coordination and timing. Constructed of surgical tubing, a heavy duty canvas pouch and tear proof vinyl grips. Each set includes 1 sling shot, 1 filler nozzle and 72-4" biodegradable balloons. Adult supervision is recommended. **CHOKING HAZARD (6) - BALLOON.** Not for under 8 yrs.*

15529 Water Balloon Sling Shot Set **\$17.99 set**
15629 Extra Balloons (144-pack) **4.99 pk.**



HumanHoops™

A new spin on tossing games!

Simply weave the "D" ring buckle belts through the basket webbing and secure around the waist to instantly create a moving, catching and tossing goal! Ideal for relays, team building and more. Use foam or fleece balls for safe tossing fun! Set of six includes 6 baskets (one of each color), 6 belts and activity guide.

15864 **\$46.99 set**



Belly Bumpers

Human bumper cars!

A terrific aggression release; kids will benefit from the cardiovascular workout they'll get from bumping. Made of heavy duty vinyl with two molded plastic handles on top. Not recommended for pool use. **CHOKING HAZARD (1) - SMALL PARTS.** Not for under 3 yrs.*

15475 36" For ages 12 and under **\$57.99 ea.**



Double Potato Sack

Stitched together for partner fun!

Talk about team work and coordination! Classic, genuine, burlap potato sack with double stitched seams provide each user a 24" wide compartment. Measures 48"W x 40"H.

16020 **\$9.99 ea.**



Poly Potato Sack

Durable and easy to clean!

Made from a heavy duty polyethylene that allows you to wipe away mud and water. Measures 40"L x 23"W.

16807 **\$39.99 SALE \$33.97 dz.**



Potato Sacks

Enhances motor skills and coordination!

Large heavy duty burlap bag, ideal for repeat use. Just like the kind grandpa used in the old county fair races. Each bag measures 36"L x 22"W. Pack includes 12 Potato sacks.

13002 Potato Sack **\$2.99 ea.**
13155 Potato Sack Pack **35.80 SALE 30.97 pk.**

*Full **CHOKING HAZARD** descriptions on page 355.

TUG-OF-WAR ROPES



Tug of War Ropes

Encourages teamwork while developing strength and endurance. Each rope has a firmly woven "anchor man" end loop. Now offering a variety of diameters and materials to suit multiple age groups.

	SIZE	1"	1.5"	2"
MANILA	25'	X20002 \$44.99 ea.	X20020 \$144.99ea.	X20024 \$211.99ea.
	50'	X20003 79.99 ea.	X20021 217.99 ea.	X20025 327.99 ea.
	75'	X20015 104.99 ea.	X20022 297.99 ea.	X20026 460.99 ea.
	100'	X20016 133.99 ea.	X20023 377.99 ea.	X20027 590.99 ea.
UN-MANILA	25'	X20030 \$76.99 ea.	X20034 \$136.99ea.	X20038 \$185.99ea.
	50'	X20031 112.99 ea.	X20035 209.99 ea.	X20039 302.99 ea.
	75'	X20032 149.99 ea.	X20036 290.99 ea.	X20040 449.99 ea.
	100'	X20033 183.99 ea.	X20037 371.99 ea.	X20041 583.99 ea.
POLYDAC	25'	X20042 \$83.99 ea.	X20046 \$150.99ea.	X20050 \$186.99ea.
	50'	X20043 122.99 ea.	X20047 217.99 ea.	X20051 327.99 ea.
	75'	X20044 159.99 ea.	X20048 297.99 ea.	X20052 460.99 ea.
	100'	X20045 197.99 ea.	X20049 378.99 ea.	X20053 590.99 ea.

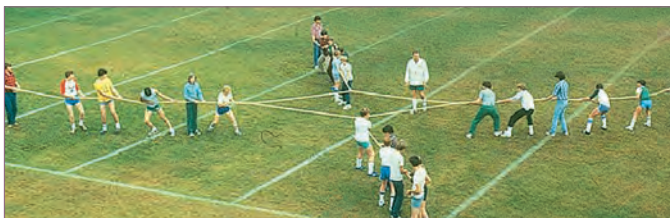

4 Team Tug of War Ropes

Encourages isotonic pulling to achieve group goals or let each team fend for themselves! 20' team lines extending from 10' square with hand loops on each end.
X20001 Manila-1" Diameter Rope..... \$212.99 ea.
X20028 Un-Manila-1" Diameter Rope 243.99 ea.
X20029 Polydac-1" Diameter Rope..... 265.99 ea.

WHICH TUG OF WAR ROPE IS RIGHT FOR YOU?



MANILA
Classic Natural fiber, best used under dry conditions



UN-MANILA
Natural look and feel of manila, yet made from polypropylene, lighter and not affected by moisture.



POLYDAC
A softer feel, superior strenght and stands up best agasint UV rays, moisture and abrasion.



4 Way Tug Of War

A classic Gladiator game! Four players going in four opposite directions, trying to be the first to grab the ball from their corner. A demanding, intense, but fun physical challenge. Set includes: 1- 4 way harness, 4 belts, 4 balls, 4 cones, 8 carabineers and carry bag.

20054..... \$169.99 set



PowerPull™ Tug of War Ropes

Designed for great grip without slipping! Made from water resistant web strapping with nylon pull loops to enhance pulling ability without interference from other pullers. Permanent centerline for accurate judging. Includes anchor loops for balanced anchoring. MultiPull 4 Way Rope has 4 ropes, a center ring with pulls and anchors for up to 40 people.
20017 20 Player Rope-20 loops; 40' \$134.99 **SALE \$121.97 ea.**
20018 28 Player Rope- 28 loops; 50'..... 149.99 **SALE 139.97 ea.**
20019 40 Player MultiPull 4 Way Rope- 40 loops; 40' x 40' 299.99 **SALE 281.97 ea.**



SofTug Tug-of-War Rope

Now in 3 sizes!
 Eliminate splinters with this 100% cotton rope! Easy on the hands, a great feeling, firmly woven 1" cotton rope with a center tag. Pull tested for elementary grade levels.
X20004 50'..... \$169.99 **SALE \$139.97 ea.**
X20009 75'..... 179.99 **SALE 157.99 ea.**
X20010 100' 199.99 **SALE 185.97 ea.**



Tug Ball™

A fast paced tug of war game! Run, pass and kick the ball in any direction to get your ball to the goal. Teams then tug for extra points! Play involves quickness and agility combined with power and stamina. The 9" diameter vinyl ball is enclosed in nylon web strapping and will endure heavy play. Includes activity guide.
16018..... \$59.99 ea.



BEAN BAGS



Animal Bean Bag Sets

Your classroom will come alive with these cute, adorable animals! Soft, pellet filled with vinyl covering and silkscreened eyes. Bean bag sizes vary and are approximately 4.5" x 3". Available in a set of 6.

- 26004 SET OF 6 Turtles..... \$19.99 set
- 26025 SET OF 6 Frogs..... 19.99 set
- 26027 SET OF 6 Variety Pack-Bunny, Penguin, Frog, Lizard, Lion and Platypus..... 20.99 set

Animal Bean Bag Assorted Class Pack

A 24 piece surprise assortment set of cute animals! You get a surprise assortment of frogs, turtles, hippos, alligators, penguins, bunnies and lizards! All animals are made from heavy duty PVC vinyl silkscreened on eyes. Includes storage bag.



- 26003..... \$79.99 pk.



Sea Critters Bean Bag Set

Filled with weighted plastic pellets for feel and sensation! Made from a spun rubber vinyl, low bounce, cleans easily, and has a great feel. Set of 6 critters include: octopus, whale, fish, blow fish, seal and turtle.

- 26020..... \$38.99 set

DOUBLE-SIDED BEANBAGS!



NEW

Marine Organisms Bean Bags

Neoprene shell with plastic pellets. Each bean bag has a soft outer cover with a picture of a marine organism on the front side and its corresponding name on the back. Measures 4.5" in diameter. Set of 12.

- 26091..... \$34.99 set



Alphabet Bean Bags

Pack of 26 bean bags! Heavy canvas. 5" x 5" bean bags imprinted with upper and lower case letters. Assorted colors.

- 26010..... \$29.99 SALE \$25.97 set



Numbered Canvas Bean Bags

Numbered 1-10. Heavy canvas 5" x 5" pellet filled assorted colored bean bags.

- 26015..... \$15.99 SALE \$13.97 set



Tendril Ball

Rubber band-like tentacles cushion on impact.

Silky soft, easy to catch and super safe! A wonderful tactile ball with its eye catching colors, limited bounce and roll. Available in two sizes. Set of 6 available in 3.5" size only.

- 10281 Oversize 4.5" Multi-Colored..... \$4.99 ea.
- 10282 Regular 3.5" Assorted colors..... 4.99 ea.
- 16142 SET OF 6 Regular 3.5"..... 31.99 SALE 24.97 set



Garden Heroes™ Bean Bags

Plush fruit and vegetable characters will be a hit in your classes!

Designed with P.E. in mind! Weighted for great tossing and embroidered so no parts come loose! Durable seams, machine washable. Measures 3" to 7" tall. The Fruit & Veggie Fun Book includes creative and challenging elementary games and activities for physical education. Book provides equipment lists, set up diagrams, instructions and more. Kit includes Fun Book, 12 Fruit & 12 Veggie Garden Heroes.

- 50310 Fruit & Veggie Fun Book & 24 Garden Heroes..... \$99.99 kit
- 50311 Fruit Garden Heroes Set of 12..... 49.99 set
- 50312 Veggie Garden Heroes Set of 12..... 49.99 set

BEAN BAGS



Fleece Bean Bags

These fuzzy bean bags are a favorite with kids. An exciting fabric that will bring new life into any bean bag activity. These plastic pellet filled bean bags are covered with a soft, furry, polar fleece cover. The feel is irresistible. Sold in dozen pack only, two of each color.

- 26011 SETOF12 4" Square \$10.99 dz.
- 26012 SETOF12 5" Square 13.99 dz.



Canvas Bean Bags

Nice weight and feel! Pliable canvas bags filled with plastic pellets. Available in two sizes- 4" or 5". Sold in dozen sets, 2 of each color.

- 26009 SETOF12 4" \$11.99 dz.
- 26050 SETOF12 5" 13.99 dz.



Vinyl Square Bean Bags

Heavy vinyl with plastic pellets. Shipped in six colors, 2 of each per dozen.

- 26070 SETOF12 3" \$13.99 SALE \$9.97 dz.
- 26071 SETOF12 4" 14.99 SALE 11.97 dz.
- 26072 SETOF12 5" 16.99 SALE 12.97 dz.
- 26073 SETOF12 6" 24.99 SALE 21.97 dz.



Nylon Bean Bags

For activities that need a bean bag that slides! Made out of durable, double stitched nylon, making them easy to clean and able to stand up to everyday wear and tear. Shipped in 6 colors 2 of each color.

- 26077 SETOF12 4" \$13.99 dz. SALE \$9.97 dz.
- 26078 SETOF12 5" 14.99 dz. SALE 10.97 dz.



Bean Bag Mega Class Packs

You choose the bean bag you want! Just the basics here: 48 bean bags- 24 of the 4" and 24 of the 5" and a black 24" x 36" Ultra-MESH™ Shoulder Bag for transport and storage. Your choice of bean bags: canvas, nylon, vinyl or fleece.

- 66101 Canvas Mega Pack - 48 bean bags & bag \$53.99 SALE \$44.97 pk.
- 66102 Nylon Mega Pack - 48 bean bags & bag 58.99 SALE 41.97 pk.
- 66104 Fleece Mega Pack - 48 bean bags & bag 53.99 SALE 44.97 pk.
- 66103 Vinyl Mega Pack - 48 bean bags & bag 61.99 SALE 46.97 pk.



Bean Bag Bocce Class Pack

For up to 48 players! Get the whole class involved with this set of 48 bean bags and 12 bean bag jacks. Pack includes four dozen 5" nylon bean bags and one dozen 3" vinyl bean bags. Divide class by colors and use the 3" bags as your targets. Use extra 3" bean bags for dual target games. Includes mesh tote bag for storage.

- 66105 \$65.99 pk.



ZONE Floor Target Toss

Easy to set up! Durable vinyl mat provides a quick target for tossing games. Ships rolled up so it lays flat and can be used indoors or outdoors. 60" x 48".

- 17239 \$29.99 ea.

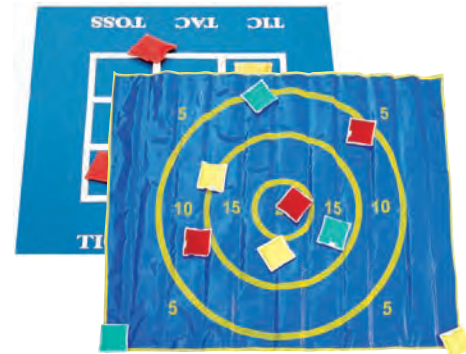

Tic-Tac-Toss/Bull's Eye Mat

Two sided toss mat! Made from PVC vinyl with silkscreened markings on both sides. Folds and stores in a nylon bag included. Measures about 54"W x 43"H square. Includes 9 bean bags 4" x 4", yellow, red and blue.

- 26030 \$39.99 ea.

BEAN BAG GAMES

The Official Baggo Game

Raise your bean bag toss game to a new level!

Distance regulator measures board placement for official Baggo action! Boards face each other with players standing and tossing bean bags from the side. Players toss the bean bags onto the board or in the hole for points. Boards are made from sturdy polyethylene with vinyl surfaces to withstand heavy use. The set comes with 2 boards, 8 twill bean bags, instructions, rules, distance regulator and wall bracket for mounting. Boards nest together for compact carrying and storage. 20"W x 34"L, weighs 20 lbs.

X15579 Official Baggo Game..... \$109.99 **SALE \$99.97 set**

15593 Replacement Bean Bags-Set of 8; 4 Red and 4 Blue 19.99 set



BEAN BAGS STORE AWAY INSIDE; FOLDS FLAT FOR STORAGE



Custom Baggo Game

You design it!

Send us your logo or design style via email and we'll take care of the rest! We will also send you an artwork approval to be signed off. Minimum of 3 Baggo Games per design. Call Customer Service for additional details.



X15592 Custom Baggo Game Set; Minimum Order 3 sets \$144.95/3+



Bean Bag Toss Class Pack

Get the whole class involved!

Pack includes two different toss game boards, 12 buckets, a tic-tac-toe mat and a 48 nylon bean bag mega pack with storage bag.

66590 \$202.99 **SALE \$189.97 pk.**



INCLUDES 10 TRIANGULAR BEAN BAGS IN 2 COLORS

4FUN 6-in-1 Table Toss Game

Switch between 6 different games in just seconds.

Includes six games: corn hole, poker pass, football frenzy, shuffle board, tic-tac-toe, and Skee-Bag. Built-in storage compartment keeps games organized. Convenient handles and wheels. Measures: 38½"L x 25"W x 8"H.

17391 \$169.99 ea.



3 Hole Bean Bag Toss

3 chances to score on the board!

Lightweight composite construction with mesh pockets, score keeper on each board and folding design for transport and storage. Includes 4" bean bags- 3 blue and 3 black and carry case. Measures 18"L x 24"W.

16160 \$49.99 ea.



NEW QUICK AND EASY SETUP!

Franklin® Kids Bean Bag Toss

Pyramid toss for points!

Includes sturdy 31" x 33" PVC frame with nylon target face and mesh pockets, six bean bags (3 red & 3 blue) and carry box. Compact foldable legs. Easy assembly.

16021 \$36.99 set



Challenge™ Bean Bag Toss

Multi-point toss game!

More scoring opportunities for greater success, fast games and more fun! Sturdy 40" x 40" steel frame supports the poly/PVC throwing target with 5 score zones. Includes 6 bean bags and carry bag to take anywhere!

15121 \$26.99 ea.

BEAN BAG GAMES



TriGoal Toss Pack

For color matching toss games!

Create exciting, fast paced games, relays and more! Each side of the TriGoal is color coded for easy matching, creating different point values or for directional play. Made from pop wire and nylon technology, the TriGoal™ simply twists and folds for easy set up and storage. Unique top zipper feature quickly aligns the net and reinforces stability. Includes 6 steel pegs to use on grass and 3 rubber weights for indoor or turf play. The 3 sided net measures 48" W x 39" H. Includes three 8" diameter starting spots and twelve 8" boundary spots. Includes carry bag and directions to play Circular Soccer. Pack includes 1 TriGoal Net and 6 dozen 4" canvas bean bags in 6 colors.

66721 TriGoal Toss Pack \$181.80 **SALE \$139.97 pk**
 16580 TriGoal Net only 109.99 **SALE 89.97 ea.**



Team Toss Class Pack

Race to score points!

Simply divide the class into 6 color groups, have relay tosses or add locomotor skills, exercises or an obstacle course into the tossing fun! Set includes 48 canvas 4" bean bags in colors and 6 targets with adjustable 16" steel coated frames.

66527 \$226.90 **SALE \$179.97 set**



ZONE Indoor Bocce Set

For up to 6 players!

Less rolling makes this set perfect for playing inside! Made with a durable neoprene cover. Includes: 12 balls (2 of each color), 1 jack, and carry bag.

17240 \$59.99 **SALE \$48.97 set**



ZONE Pellet Balls

The pellets limit rolling!

These pellet filled tacky vinyl balls are great multipurpose balls. Because of their size and weight, they are great for indoor tossing games where you need a "limited roll" for bocce type games, juggling, bean bag toss games and Adapted PE students love the tacky cover and sensory feel from the pellets inside the balls. Size is 2 1/2" diameter.

18252 SET OF 6 \$26.99 **SALE \$19.97 set**



6 Color Target Set

Create scoring stations, spread out for distance tossing or use colors for points!

Fully adjustable for increased challenge, set up for distance throwing, disc golf practice or team relay throwing contests. Made with a powder coated steel frame with a 16" diameter netting. Sold in set of 6 or individually in blue only.

27137 SET OF 6 \$114.99 **SALE \$105.97 set**
 27001 Assorted colors 23.99 **SALE 19.97 ea.**



Baseball & Golf Bean Bag Game

Two great games in one!

Play 9 innings of baseball or 18 holes of golf! Excellent toss game made from 3/4" thick corrugated plastic built to withstand heavy play. Board measures 24" x 36" with 10 scoring holes. Includes 6 bean bags, score sheets for both games and rules.

X15577 \$69.99 ea.



Bean Bag Bucketz

Just aim, toss, and score.

Combines classic concepts from games like bean bag toss and disc golf.

First team to reach 21 by tossing their bags into the multi-level buckets wins. Each level counts for a different point amount. Includes: 16 bean bags (8 blue/8 yellow), 7 buckets, stand and carrying bag. Assembled height: 60" tall.

17393 \$59.99 set



Buckets

Multiple uses for multiplied fun!

Use these buckets for obstacle courses or relay races. Stack them for challenging target games or cooperative group activities. Made of a heavy duty vinyl resin and standing 8.5" high and 8" diameter, these buckets will withstand your toughest class.

15609 Assorted colors only \$4.99 ea.
 15607 Set of 12, 3 of each color 39.99 set
 16023 Set of 36 Buckets 9 ea. color 99.99 set

GAMES



ZONE Exer-Dice

11 different exercises- no equipment necessary! Lunges, push-ups, bicycle, crab kicks, jumping jacks and more. Dice are made from firm foam with a durable vinyl cover. They measure 6.25" high. Sold in a set of 6 or individually in assorted colors.

- 16982 SET OF 6 \$114.99 **SALE \$99.97 set**
- 17146 Individual Exer-Dice Assorted Colors 21.99 **SALE 18.97 ea**



ZONE Exer-Dice Packs

Pair up with our 20 sided dice! Divide classes into 6 color groups for easy warm ups and cool downs! Pack includes 6 Exer-Dice and 6 20 Sided Dice. Exer-Dice Mini pack includes: 1 Exer-Dice and 1 20 Sided Dice in assorted colors.

- 66701 Exer-Dice Pack- 6 of each dice \$173.50 **SALE \$114.97 pk.**
- 66735 Exer-Dice Mini Pack- 1 pair; assorted colors 24.50 **SALE 21.97 pr.**

ZONE Pocket Cubes

Create your own activity cubes! Use for repetition markers, quick quizzes, station activities, field day and more! These 6" cubes are poly filled with a vinyl covering and have clear, thick pockets that will hold a 5.75"L x 5.25"H piece of paper. Sold in a set of 6.



- 16981 SET OF 6 \$48.99 set



ZONE 20 Sided Dice

More options for number fun! Made from durable polyurethane with molded in numbers that won't wear down. 6" tall. Set of 6.

- 16161 SET OF 6 \$34.99 set



Foam Dice Set

Soft, safe and colorful! Use these soft vinyl dice for number practice or playing games. 3" dice are soft and safe to toss around. Sold in set of 6.

- 15034 SET OF 6 \$20.99 **SALE \$16.97 set**



Coated Foam Dice

Soft, safe and very economical. These 6" vinyl Coated Foam Dice will be a center part of many games or just for counting practice. Sold in sets of 2. Yellow only.

- 15013 \$13.99 set



WonderFoam® Block Set

Use in a variety of manners! High density 1 1/2" square foam blocks with letters, numbers, pictures and words will help with spelling, counting and recognizing words. Set of 30 blocks.

- 15284 \$35.99 set

Hopscotch Mat

A soil and stain resistant washable carpet. Withstands rugged wear and has a durable latex gel skid proof backing. Meets ASTM safety standards, has the highest anti-flammable rating in the industry. Measures 80"L x 26"W, includes 2 bean bags.

- 15576 \$49.99 ea.



NEW

jWAY Hopping Game

An interactive spin off traditional hopscotch. Players compete to take over the board. The player with the most spaces claimed when the board is all filled up wins. Includes: game board (6' x 6'), dry erase marker, board stickers, activity guide poster, rules and carrying case.

- 17392 \$79.99 ea.



Sidewalk Chalk

Every kids favorite! Use for writing and creating on the sidewalk or making boundaries for four-square, hopscotch or other ground games. Instantly disappears with water. Each box contains 36 pieces of 4" non-toxic biodegradable chalk in assorted colors. **CHOKING HAZARD (1) - SMALL PARTS.** Not for under 3 yrs.*

- 15007 \$9.99 bx.

* Full **CHOKING HAZARD** descriptions on page 355.

MULTI-USE APARATUS



Multi-Domes™

New and more functional design!

New design now holds any diameter hoop including Skinny No-Kink Hoops! Now with 4 perimeter holes for dozens of new over, under and through obstacles. Constructed with heavy ABS plastic, they will withstand rough daily use. With a center cavity and horizontal slot, you can quickly create a complete obstacle course or target game. Multi-Domes™ measure 9" in diameter and 5" high and weigh up to 12 lbs. when filled with sand. Junior Multi-Domes™ measure 6" in diameter and 4" high and weigh up to 6 lbs. when filled with sand. Either style is sold in a set of six, one of each color. Hoops not included.

- X13162 SET OF 6 6" Multi-Domes™ Jr. \$69.99 set
- X13057 SET OF 6 9" Multi-Domes™ 105.99 set
- X13098 9" Multi-Domes™ Assorted Colors 18.99 ea.

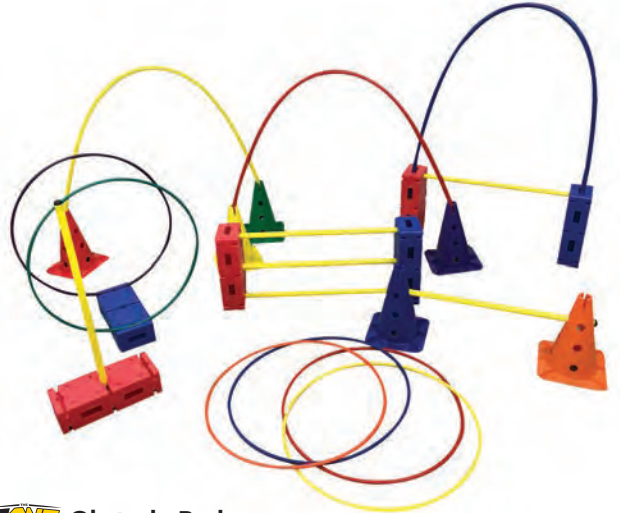

ZONE Obstacle Pack

Create multiple obstacles to climb through, over, under or around!

This pack includes 6 plastic 28" poles to use as hurdles or agility sticks, 6 Skinny No-Kink 24" hoops for use as targets or crawl zones, 3 multi-use arches for crawl unders, 6 plastic 14.25"L x 5.87"W x 3.75"H bricks with three openings for poles and 6 slotted 12" The Zone Cones with multiple openings for pole placements.

- 13159 \$120.93 SALE \$114.97 set



Multi-Dome™ Activity Pack

For use with hoops and poles!

Pack includes 6 multiple-attachment stems with colored posts and 6 Multi-Domes™ to create obstacle courses using hoops and poles. Hoops and poles sold separately. Course shown with two Multi-Dome™ Activity Packs.

- 13160 Multi-Dome™ Activity Pack: 6 stems with 6 colored posts & 6 domes \$194.99 pk.
- 13060 Activity Kit: 6 stems with 6 colored posts only 96.99 kit
- X13057 SET OF 6 9" Multi-Domes™ only 105.99 set



Over-N-Under™ Training Hurdles

Swings away on contact!

Use multiple height cones for a variety of challenges. Bars measure 28" long with a 1" diameter. Cones sold separately.

- 42159 SET OF 6 \$79.99 set



Multi-Dome™ ArchGates

Use your imagination!

These ArchGates can be used to create your own 30" goals, obstacles, tunnels and more! For use with 9" Multi-Domes™ sold separately. (X13057)

- 15125 SET OF 6 \$56.99 set



Action Domes™ Obstacle Pack

Create poles, arches or hoops for your classes.

Pack includes 12 high impact 34" poles, sectional segments to create high arches or hoops and a set of 24 Action Domes™. The 5 hole dome has a locking center hole- use with a single post for obstacles or use with hoop holders and snap together segments to create crawl tunnels or tossing targets. Use the four side holes for horizontal pole positioning to challenge users with jumping activities. Use the dome alone for balance challenges, as floor markers, simple goals and more. Dome Obstacle Kit includes six 34" high impact poles, sectional segments to create six 24" high arches or six 30" diameter hoops. Domes are made from impact resistant plastic with a 9" diameter and 4" height.

- 13161 Obstacle Pack: 12; 34" poles, sectional segments and 24 Action Domes™ \$209.99 pk.
- 13142 Obstacle Kit only: 6; 34" poles and sectional segments only 99.99 kit
- 13141 Set of 24 Action Domes™ only 36.99 set

Multi-Dome™ Floor Tennis Net

Portable, compact and easy to store!

Simply insert posts into the Multi-Domes™ and slide the net corner pockets down over the post. No system sets up more quickly. Net measures 10'L x 30"H with vinyl/nylon sleeves and tape. For use with 9" Multi-Domes™ sold separately (X13057).

- 15111 \$74.99 SALE \$66.97 set



TUNNELS & MAZES



BENDABLE NOODLE CONNECTORS

Foam Noodles & Noodle Connectors

Hundreds of uses outside of the pool!

Create safe obstacle courses, make foam hurdles, target circles or cut them up and use as pins or taggers. Makes a great fitness item as well. Connectors are bendable foam inserts that join multiple noodles into various shapes, targets, goals, crossbars and more! Choose from two sizes of connector.

- X58021 Foam Noodles - Box of 12, Assorted Colors, 58"L x 2.75"D..... **\$75.99 box**
- 32363 Noodle Connectors 6" - Set of 12..... **31.99 SALE 24.97 set**
- 32362 Noodle Connectors 10" - Set of 12..... **39.99 SALE 29.97 set**

Tunnels of Fun

A 4 way tunnel with a mesh center!

Set includes four 3' long, 18" diameter tunnels, one 18.5"H x 35.5" diameter tunnel junction and nylon storage bag.

Unit is made from 70 Denier polyester

Taffeta with an easy to clean, moisture proof polyethylene floor.

Mesh center provides ventilation and visibility.

Self-erecting pop up design, folds in seconds for storage.

15884 9'L x 9"W x 2'H **\$98.99 ea.**



6' Multi-Color Tunnel

Folds flat for easy storage!

Sturdy steel spring construction keeps its shape and the padded interior wires keep play safe! Made from flame retardant 70 Denier Nylon and has a 19" diameter. Great for hours of fun play!

15885 6'L x 19" diameter **\$43.99 SALE \$38.97 ea.**



Elementary Obstacle Course Class Pack

A perfect selection of shapes, beams, tunnel, arches and more to set up a fun, creative and challenging obstacle course for elementary level students.

- 1 ea. 15885 6' Tunnel
 - 1 ea. 45036 Curve-A-Beam
 - 1 set (6)13147 7"-12" Foam Spots
 - 1 ea. 13142 Dome Obstacle Kit
 - 1 set (6)13148 Geometric 10" Shapes
 - 1 set 13141 Action Domes Set 66540
- \$297.90 SALE \$249.97 pk.**



INSTITUTIONAL QUALITY

Institutional Polyester Dacron Tunnel

15' long with a 24" opening!

Features sturdy frame construction and padded interior for safer play. Flame retardant fabric meet CPAI-84 standards. Fold down flat with Velcro for easy storage.

17225 15'L **\$119.99 ea.**



Mesh Play Tunnel

They can see out and you can see in!

Ideal for children who are timid about crawling in tunnels and excellent for maintaining proper supervision. This tunnel has a sturdy steel spring instruction with fine durable mesh with 70 Denier Nylon ends and cover and padded interior for comfort and safety. Folds flat for easy storage. Measures 6' long with a 19" diameter.

15886 6'L x 19" diameter **\$34.99 ea.**

SPEED STACKS



Speed Stacks Sport Packs

The most economical way to get a sport stacking program started.

Provides everything you need for a successful sport stacking program with enough equipment for your entire class to participate at once. Step by step instructions and curriculum available. Choose from a 15 or a 30 set package. 30 set pack includes: (5) stacks ea. (red, blue, green, yellow, orange & purple), 6 StackMats w/ timer, curriculum guide, and soft carry case. 15 set pack includes: (5) stacks ea. (red, blue, & green), 3 StackMats w/ timer, curriculum, and soft carry case.

- 15713 15 Set Sport Pack.....\$399.99 pk.
- 15714 30 Set Sport Pack.....499.99 pk.



Speed Stacks®

Part of P.E. curriculums in over 20,000 schools worldwide!

Sport stacking has been shown to improve hand-eye coordination, bilateral proficiency and reaction time, leading up to many other sports and activities. Sport stacking requires players to stack and unstack 12 specially designed, high tech plastic cups in pre-determined sequences for the fastest time and allows players of all ability levels to achieve success.

- Specify Color \$19.99 set
- 16388 SET OF 6.....119.94 set

RED	ORANGE	NEON YELLOW	GREEN	BLUE	PURPLE	PINK
15705	15706	15707	15708	15709	15710	15712



Speed Stacks Jumbo Stacks

Speed Stacks Jumbo Stacks

Floor relays and doubles stacking are a whole new challenge with these large scale cups. Six different color sets of 6 Jumbo cups are included so the whole class can participate at once. Cups measure 10.5"H x 9"D.

- X15166 36 Jumbo Cups..... \$199.99 set



Speed Stacks® Skillastics® Deluxe Set

For up to 30 students!

Perfect for larger classes. Comes with everything you receive in the regular package plus Speed Stacks® stacking cups. Includes: 30 sets of Speed Stacks® with storage bag; 1, 5'x 7' big mat; 6 - 20" x 27" mini mats; 6 colored dice & beanbag markers; 26 - 5"x 7" laminated task cards; instructions, mat storage bag. ⚠ CHOKING HAZARD (1) - SMALL PARTS. Not for under 3 yrs.*

- 17277 \$849.00 set



Speed Stacks® Skillastics® Set

Combines the best of two worlds!

Learn Sport Stacking through the proven Skillastics® method. It offers 26 unique activities that enhances MVPA while simultaneously increasing Sport Stacking agility and skills. Includes: 1- 5'x7' big mat, 6 - 20" x 27" miniature mats, 6 colored dice & beanbag markers, 26 - 5"x7" laminated task cards, instructional DVD & manual, backpack storage bag. (Speed Stacks cups sold separately. Recommended 1 set per student.) ⚠ CHOKING HAZARD (1) - SMALL PARTS. Not for under 3 yrs.*

- 17274 Speed Stacks® Skillastics® Set \$229.99 set
- 16388 Speed Stacks Cups, Set of 6 119.94 set



StackMat®

Ideal surface for stacking!

Feels like a very dense mousepad with a grippy, non-slip backside. Limits cups sliding and rolling away during stacking events. Use the StackMat® with Timer for competition and can be used with the Tournament Display. For practice use the StackMat® without timer and give all students a level stacking surface. Measures 29"L x 11"W.

- 15716 StackMat® with Timer..... \$34.99 ea.
- 15717 StackMat® without Timer..... 15.99 ea.

* Full CHOKING HAZARD descriptions on page 355.

GIANT GAMES



NEW

ZONE Giant Floor Chess or Checkers

An extra-large take on the classic games of strategy.

Choose between chess or checkers. Each game comes with a 6' x 5' foldable foam mat with hemmed edges and 3.25" diameter game pieces – Chess (32) or Checkers (24). Play indoors or outside. 2 – 4 players.

- 17366 Chess \$49.99 set
- 17365 Checkers 49.99 set



Giant Chess or Checkers Set

Oversized fun for everyone.

Two great strategy games taken to a whole new size. Chess comes with 32 oversized game pieces between 17" – 25" tall. Checkers has (24) 4" high game pieces. Both sets comes with a 10' x 10' vinyl game mat and ground anchors. Play indoors or outside.

- 16030 Complete Chess Set - 32 game pieces & mat \$579.99 set
- 16031 Set of 32 Chess Pieces (only) 499.99 set
- 15897 Complete Checkers Set - 24 game pieces & mat 279.99 set
- 16029 Set of 24 Checkers Pieces (only) 226.99 set

Up 4 It
A game of skill, strategy and luck!

Take turns to drop your counters into the frame to try to form a line of 4 and stop your opponent from doing the same. Includes 42 counter discs and instructions. Game is made from heavy duty plastic and measures 57"W x 45"H x 18"D. Weighs 40 lbs.



- X10303 \$299.99 **SALE \$269.97 ea.**

Get Knotted

Lose your balance and fall over you are out of the game!

Like a giant Twister game, throw the two giant inflatable dice to find out which part of your body you have to place on which color flower! Ideal for teaching colors, left and right, listening skills and coordination. For up to 15 players. Includes giant 10' x 10' vinyl playing mat, 8 anchor pegs and 2 oversized inflatable dice.



- 15827 \$89.99 **SALE \$79.97 ea.**



Giant Dominoes

Play the classic game or turn on end to let them tumble down!

Each set includes 28 solid, sustainably sourced wooden dominoes with painted pips and smooth finish. Each one measures 7" x 3.5" x .5". Excellent for all ages. Ideal for math related activities. Includes carry bag and game instructions.

- 17165 \$48.99 set



Giant Toppling Tower

Grows to over 5 feet tall!

A game of skill and strategy! Included game sheet provides numbered activities that correspond to the numbered blocks. When each block is pulled, the activity must be completed. Also includes custom dry erase board to make your own rules. 54 solid wood blocks, each measuring 7.5"L x 2.5"W x 1.5"H and carry bag.



- X16810 \$89.99 ea.

NEW

Rollzee Giant Wooden Dice Game

All the fun of the classic family game – supersized.

Designed to bring giant size fun to any existing dice game. Each hand sanded piece is made with heat stamped number dots that will never rub off. Game set includes: (6) 3.5" x 3.5" x 3.5" dice, double sided dry erase board with pen, and canvas carrying bag.



- 17396 \$31.99 set

*Full **CHOKING HAZARD** descriptions on page 355.

Atomic Gladiator Foesball Table

With octagonal wood handles for better grip!

Features a .75" MDF play field with 1.25" solid MDF support braces and traditional style men on 3/8" chrome steel rods with nylon bushings. Big 15" x 2" thick MDF aprons, sturdy 4.75" square laminated MDF legs with 3.5" levelers. Internal ball return and entry and solid wood slide scoring. Includes 4 balls. Measures 56"L x 31.25"W x 34.75"H; weighs 189 lbs. **CHOKING HAZARD (3) - CONTAINS A SMALL BALL.** Not for under 3 yrs.*



- T16048 \$499.99 **SALE \$459.97 ea.**

MORE TABLE GAMES ONLINE

BOARD GAMES



⚠ CHOKING HAZARD (1) - SMALL PARTS. Not for under 3 yrs.*

Basic Bingo Set

Includes 7" wire ball cage, set of colored bingo balls and plastic master board.
15368 \$64.99 set

BattleShip

Game of strategy and wits. Ages 8+. 2 players.
15322 \$24.99 ea.

Candy Land

A great beginner game! For 2-4 players, ages 3-6.
15323 \$12.99 ea.

Checkers

A basic folding board and pieces.
15330 \$5.99 ea.

Chess

Defeat your opponent's king in order to win!
15339 \$5.99 ea.

Chutes & Ladders

For 2-4 players ages 4-7.
15326 \$12.99 ea.

Connect Four

Similar to Tic-Tac-Toe. For 2 players, ages 7+.
15328 \$15.99 ea.

Guess Who?

Guess the correct character! Ages 5 & up.
16812 \$21.99 ea

Dominoes

Strategy game. 28 large wood pieces. Ages 5+.
15338 \$4.99 ea.

Jenga

Remove the wooden pieces and try to keep the tower from toppling. For 1 or more players ages 3+.
15329 \$17.99 ea.

Memory

The original game of memorization and association. For 1 or more players ages 3 and up.
15342 \$13.99 ea.

Monopoly

Classic game of buying and selling, for ages 8+.
15321 \$24.99 ea.

Scrabble

A spelling game, for ages 6+.
15353 \$24.99 ea.

Sorry

A race to get your pawn home first! For 2-4 players Ages 6+.
15325 \$15.99 ea.

Trouble

The bumping back, racing ahead game for 2 to 4 players. Ages 5+.
15396 \$16.99 ea.

Twister Ultimate

A fun interaction game of balance and flexibility.
15324 \$24.99 ea.

BUY PACKS AND SAVE



⚠ CHOKING HAZARD (1) - SMALL PARTS. Not for under 3 yrs.*



⚠ CHOKING HAZARD (1) - SMALL PARTS. Not for under 3 yrs.*

Strategy Games Pack

It takes a plan to win the game!
• 1 ea. 15322 BattleShip • 1 ea. 15353 Scrabble
• 1 ea. 15329 Jenga • 1 ea. 15324 Twister
• 1 ea. 15321 Monopoly • 1 ea. 15396 Trouble
66319 \$129.99 pk.

Favorites Pack

A collection of our most popular games!
• 3 ea. 15339 Chess • 2 ea. 15328 Connect Four
• 3 ea. 15330 Checkers • 2 ea. 15325 Sorry
• 2 ea. 15353 Scrabble
66318 \$134.99 pk.

Early Elementary Game Pack

Perfect for the younger crowd!
• 1 ea. 15396 Trouble • 1 ea. 15327 Uno
• 1 ea. 15326 Chutes & Ladders
• 1 ea. 15325 Sorry
• 1 ea. 15323 Candy Land
66357 \$61.99 pk.

Classic Game Pack

Assortment of classic board games.
• 1 ea. 15322 BattleShip • 1 ea. 15321 Monopoly
• 1 ea. 15325 Sorry • 1 ea. 15330 Checkers
• 1 ea. 15396 Trouble • 1 ea. 15339 Chess
• 1 ea. 15328 Connect Four
66722 \$99.99 pk.



Uno Cards
15327 \$7.99 ea.

Playing Cards
15343 \$1.99 ea.

Classic Card Pack
66111 \$28.99 pk.

Jacks and Ball Set

Set consists of 1-1" rubber ball and 10-3/4" jacks. Not intended for ages 3 and under.

⚠ CHOKING HAZARD (3) - CONTAINS A SMALL BALL. Not for under 3 yrs.*

15331 \$1.99 set



* Full CHOKING HAZARD descriptions on page 355.

PLASTIC DISCS



Power Disc

Sold in six color sets for group play!
A great alternative for disc golf!

- 11019 **SET OF 6** Appx. 95 grams, 9" diameter \$13.99 **SALE \$10.97 set**
- 11025 **SET OF 6** Appx. 125 grams, 9.5" diameter \$14.99 **SALE 12.97 set**
- 11026 **SET OF 6** Appx. 165 grams, 11" diameter \$19.99 **SALE 15.97 set**



Class Pack

An 18 disc pack!

- Includes:
- 1 set 11019 Set of 6 9" dia. discs
 - 1 set 11026 Set of 6 11" dia. discs
 - 1 set 11025 Set of 6 9.5" dia. discs
 - 1 ea. 36114 24" x 36" white mesh bag
- 66466 \$53.00 **SALE \$39.97 pk.**



Spin Jammer® Discs

Spin like a pro!

Unique center cone provides great balance and easy spinning. Assorted colors only. Spin Jammer School Pack; sets your class up in minutes with 15 Spin Jammer® discs in assorted colors, instructional video and nine chapter guide book. Choose between the 100g 9" or 140g 10" disc pack.

- 11027 9" diameter 100g \$3.75 ea.
- 11028 Pro Comp, 10" diameter 140g 5.50 ea.
- 11031 School Pack 100g 9" diameter 71.99 pk.
- 11032 School Pack 140g 10" diameter 93.99 pk.

Frisbee® Ultimate Sport Disc

175 grams, 10.5" diameter.

Meets the official standards for the game of "Ultimate". Excellent balance and flight stability.

- 11007 Assorted colors \$8.99! ea.
- 66572 Set of 6 50.99 set



Frisbee® Freestyle Disc

160 grams, 10.5" diameter.

A truly balanced disc. Excellent flight control and stability.

- 11002 Assorted colors \$7.99 ea.
- 66573 Set of 6 44.99 set

Frisbee® Heavyweight Disc

200 grams, 11" diameter.

The slightly larger and heavier disc will fly farther and straighter in the windiest of conditions.

- 11003 Assorted colors .. \$9.99 ea.
- 66574 Set of 6 58.99 set



Frisbee® Pro-Classic Disc

130 grams, 10" diameter.

U-Flex® makes this disc flexible, easier to catch and easier to throw!

- 11048 Assorted colors \$6.99 ea.
- 66570 Set of 6 40.99 set

SOFT-SAFE DISCS



Orbit One™ Uncoated Foam Discs
Soft safe foam disc.

9" foam disc with rounded edges. Safe to throw and catch. Sold in a set of 6.
11006 SET OF 6 \$19.99 SALE \$15.97 set



Revo Disc™ Vinyl Coated Foam Discs
Soft, vinyl coated foam disc!

Soft foam coated with a durable polyurethane covering. Even weight for a true flight. Sold in a set of 6.
11022 SET OF 6 \$22.99 SALE \$18.97 set



3 YEAR GUARANTEE



Renegade™ TuffSKIN™ Discs
"Tuffest" foam disc on the market.

High density 9" foam disc with our special "TuffSKIN™" coating. Rounded contour edges make for perfect throws and catches. Sold in a set of 6.
11000 SET OF \$55.99 SALE \$48.97 set



Flex Flyer™
Folds and flexes and flies fantastic!

Made from a PVC material allowing these flyers to bend, fold and flex but still fly just like a regular flying disc. Eye catching design, great quality and safe for kids. 10" diameter. Sold in a set of 6.
11060 SET OF 6 \$30.99 set



Fun Gripper™ Disc
Tie-Dye soft cloth-like flying disc.

A totally unique design with a patented "Mega-Grip"-the same as found on our Gripper™ Balls. Stuffed with plastic pellets on the edges making it easy to catch and won't hurt like the hard plastic discs. Design allows same type of super long throws holding the disc upside down. Available in 2 sizes, both adaptable for all ages.

11151 9" \$13.99 ea.
11088 12" 14.99 ea.



Flexible Numbered Flying Disc Set
Combines comprehensive learning with fun.

Each colored disc displays a number (1-6) in English, French, German and numerical form, along with counting dots. Made of a soft collapsible vinyl with sturdy outer ring. Measures 8" in. diameter. Set of 6.
11095 SET OF 6 \$59.99 set



Flexible Number Wheel Disc

Perfect for developing catching, throwing & counting skills. Each disc has (2) six color sides. One side has numbers 1-6 in numerical form. The other side displays 1-6 in English, Spanish and French, along with counting dots. Made of a soft collapsible vinyl with sturdy outer ring. Measures 8.5" in. diameter.
11096 \$17.99 ea.

DISC GAMES



ZONE DodgeDISC

A softer and lighter alternative to the DodgeBee® Disk. Use as a non-threatening substitute to hard disks. Also great for catch and target games. Constructed of a durable nylon cover with foam inserts. DodgeDISC game instructions included. 10" diameter. Color may vary.

- 17242 Single, Assorted Colors \$13.99 **SALE \$9.97 ea.**
- 17368 SET OF 6 69.99 **SALE 54.97 set**



ZONE Flying Saucer Face Off

An exciting spin on the original Alien Spaceship Battle. Gameplay is similar to the rules of Alien Spaceship Battle. However, additional strategy is needed. Teams arrange their ships and targets on their side of the court. Soft ZONE DodgeDISCS are placed on the baselines. At the signal, students launch their flying saucers (discs) at the opposing alien targets. The first team to knock them all over wins. Game includes 34 weighted alien targets, 10 foam UFO bases and 18 DodgeDISCS – 3 sets of 6. **66825 \$359.99 set**



DodgeBee®

A versatile safe disc used by itself or in the game of DodgeBee!

Set up like a typical dodgeball game, the exception with DodgeBee is that players who are "out", still remain active. They move to the 3 sides surrounding the opposing team and DodgeBee is played from all sides. Made from a heavy duty nylon canvas with a soft foam reinforced deep rim for excellent grip and true flight. Assorted colors. Includes instructions.

- 11068 11" DodgeBee Disc \$15.99 ea.



Disc Slam™

Score extra points through the front slot!

Players score points by throwing their disc through the target slot or having their partner tip the disc into the open top. Targets are made of nylon and measure 19" high with a 15" diameter. Class Pack includes 12- 8.5" discs, 12 collapsible targets and storage bags.

- 16040 Disc Slam: Includes two 8.5" discs, two collapsible targets and storage bag. \$29.99 set
- 66548 Class Pack- 24 players; 12- 8.5" discs, 12 collapsible targets and storage bags. 164.99 pk.



The Satryan Ball™ Foam

It's part disc and part ball, but all fun.

Satryan ball can be tossed like a flying disc or kicked and bounced like a ball or turn it on its side and it bounces. The foam set is made with a durable polyurethane foam core and cover. Discs measure 8" in diameter.

- 17412 Satryan Foam SET OF 6 \$86.99 set



Beamo®

It just glides through the air!

Soft and safe, these discs are made from lycra with foam encased edging for safety. Use indoors or out with any age group! Super lightweight, yet glide's smooth through the air! Assorted colors.

- 11101 30" diameter \$22.99 **SALE \$19.97 ea.**
- 11103 15.75" diameter 9.99 ea.



Aerobie® Discs

Easy to grip- easy to throw!

Perfectly balanced, made with soft flexible edges for easy catching. Assorted colors.

- 11015 Pro Ring- 13" diameter \$8.99 ea.
- 11016 Sprint Ring- 10" diameter 7.29 ea.



Kan Jam Game
Improves coordination!

Partners toss the disk toward their goal and score points by hitting the goal or deflecting the disc in. Goals are made of plastic and fold flat.

- 16171 2 goals, 1 official 11" disc and instructions \$39.99 set
- 16172 School Set- 20 players; 10 goals, 5 official 11" discs and instructions 169.99 set
- 66575 Class Pack- 40 players; 20 goals, 10 official 11" discs and instructions 339.98 pk.



DISC GAMES



Class Pack Target Set

Divide classes by colors or use colors for scoring!

Fully adjustable for increased challenge, set up for distance throwing, disc golf practice or team relay throwing contests. Made with a powder coated steel frame with a 16" diameter netting. Ideal for throwing, catching and disc golf lead up. Pack includes 2 sets of 6 Colored Targets and 36 competition 9.5" diameter, 125 gram discs (6 of each colors).

66314 Class Pack- 12 targets and 36 discs **\$319.90 SALE \$263.97 pk.**
27137 SET OF 6 Targets only..... **114.99 SALE 105.97 set**



NEW

Verti-Goal™

A simple vertical goal system for team games and skills practice. Ideal for indoor/outdoor passing activities such as disc sports, football and team handball. Easy hanging installation via Velcro straps. Nylon ribbons allow for visual confirmation of successful throws. Includes 1 goal. 26" diameter.

11097 **\$59.99 ea.**



Disc Dive

A fun outdoor disc toss game!

Hit the pole for 1 point or knock the bottle off for 3 points! First to 21 wins! Adjustable chrome pole with multiple height options for increased playability. Lightweight with a folding base with a built in stake system for outdoor play. Includes 2 targets, 2 scoring bottles and a disc.

16814 **\$60.99 set**



Nine Hole Deluxe Disc Golf Set

Comes with everything you need!

A challenging and fun activity for students and group play! Complete set with everything you need to just set up and play. Set includes 9 lightweight durable PVC and plastic numbered 48" targets, 36- 95 gram discs, 9 steel ground sockets and a heavy-duty nylon 36"L x 18"W carry bag to store and transport entire set. Disc Golf Equipment Cart sold separately.

X15825 9-48" targets, 36 discs, 9 sockets, storage bag **\$449.99 SALE \$434.97 set**
X15569 Disc Golf Cart-can hold entire Disc Golf Set..... **309.99 SALE 289.97 ea.**

55"H x 24"W x 21"D



Outdoor Disc Golf Set

Create your own course!

Offer your students an exciting, challenging and fun activity that will help them develop coordination, cooperation and confidence. 9 hole set includes 9 numbered target hoops, (3-40" hoops, 3-52" hoops and 3-64" hoops), 9-90 gram discs, 9-10" numbered plastic "tees" and 9 steel ground sockets. 3 hole sets come with target hoops and ground sockets only. The 9 Hole Indoor Course includes: 3- 40" center, 3- 52" center and 3- 64" center height targets, 9 discs and 9- 14" diameter steel bases.

X15652 Outdoor 9 Hole Complete Set-9 hoops, 9 discs, 9 tees, 9 sockets..... **\$374.99 set**
X15829 Outdoor 3 Hole set- 1-40", 1- 52", 1- 64" hoops, ground sockets..... **179.99 set**
X15651 Indoor 9 Hole Set- 9 hoops, 9 discs, 9 bases..... **734.99 set**



Outdoor 9 Hole Complete Set

Indoor Outdoor

DISCS



Innova® Polecat All Purpose Golf Discs

One of our most popular Middle School golf disc.

A perfect way to introduce your class to Disc-Golf. Colors may vary

11033 110 grams; 20.5 cm diameter **\$6.99 ea.**

11078 Class Pack of 24 with storage bag **167.76 SALE 151.97 set**

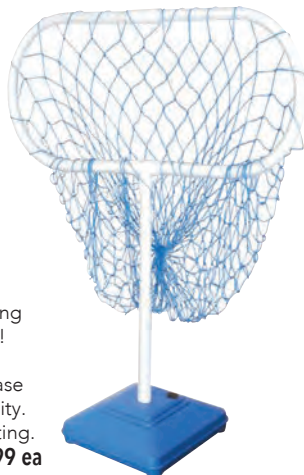

Disc Target

A multi-use target for discs and more!

A single unit target hoop with an opening of 14" x 30" to catch whatever you toss!

Telescopic pole allows for three height adjustments: 24", 34" or 36". Square base

fills with sand or water for greater stability.

Made from durable PVC with mesh netting.

X15635.....**\$36.99 ea**



Franklin 3 Disc Golf Pack

Suitable for beginners and advanced players to hone their skills!

Set features three specially-engineered discs that are ideal for tournament or recreational play. Pack includes 1 Albatross 160g driver engineered for maximum distance, 1 Sparrow 160g mid-range disc engineered for maximum stability and 1 Night Owl 167g putter engineered for accuracy.

11104 3 Disc Golf Pack **\$12.99 pk.**

11108 Large 36 Pack with Storage Bag **149.99 pk.**



Innova® DX Golf Discs

Excellent beginner discs at an affordable price!

An excellent all weather disc. Assorted colors.

11038 Leopard Fairway Driver Disc-175 grams; 21.2 cm diameter..... **\$7.50 ea.**

11036 Shark Mid Range Disc 175-grams; 21.2 cm diameter..... **7.50 ea.**

11037 Aviar Putt & Approach Disc-175 grams; 21.2 cm diameter..... **7.50 ea.**

11035 Set of 3, 1 each; Leopard, Shark, Aviar **21.99 set**



CHOOSE 3 OR 9 TARGET PACKS WITH 24 DISKS!

Beginner Disc Golf Pack

Start off with a great multi-purpose disc and pop up target!

Pack includes 24 Polecat 110 gram stable flying discs, a carry bag for the discs and your choice of a 3 DISCatcher Traveler pop up target or 9 target pack. Play indoors or outside.

X66577 24 discs, bag & 3 targets..... **\$529.97 SALE \$529.97 pk.**

X66578 24 discs, bag & 9 targets..... **1,247.97 SALE 1,247.97 pk.**

DISC GOLF TARGETS



DISCatcher® Traveler Target

Simple one step set up!

Official height target made with lightweight, durable mesh netting, nylon reinforced edges, official chains, metal 5 leg base and sturdy upright frame. Weighs less than 15 lbs. and measures 30"W x 64"H. Includes removable flag and carry bag.

X11063 Red.....	\$133.99 ea.	X11092 Black	\$133.99 ea.
X11064 Blue	133.99 ea.	X11093 Orange	133.99 ea.
X11066 Yellow.....	133.99 ea.		
X11079 3 Target Set - 1 red, 1 blue, 1 yellow.....			379.99 set
X11053 9 Target Set - 3 red, 3 blue, 3 yellow.....			999.99 set



Skill-Shot™ Target

Folds down for storage and transport!

A 3 legged steel base supports the heavy canvas basket with stopper chains and cover. Eye catching flag at top for aiming. Measures approx. 66" tall and 27" wide. Approved by the Professional Disc Golf Association.

X15630 Skill-Shot Target- Blue only	\$146.99 ea.
X15695 3 Target Set- 1 red, 1 blue, 1 black	419.99 set
X15690 9 Target Set- 3 red, 3 blue, 3 black	1,149.99 set



Permanent or Portable DisCatcher
Professional model Disc-catcher.

Create your own disc Golf Course with these professional disc catchers. The lower basket is constructed of metal, galvanized chain and thick oven baked paint. Stands 4' above ground with a permanent in-ground installation. The target basket is 26" wide. The chain hangs from the top of a 22" diameter frame and deadens the disc on impact. Also available is this same unit attached to a 23.5" round base allowing for a portable unit. Each unit comes un-numbered, but if specified when ordering, units can be numbered for no extra charge.

X15567 Permanent.....	\$459.99	SALE	\$429.97 ea.
X15568 Portable.....	459.99	SALE	429.97 ea.
X66581 Permanent 3 Target Set.....	1,299.99	SALE	1,199.97 set
T66582 Permanent 9 Target Set	3,550.99	SALE	3,449.97 set
X66583 Portable 3 Target Set	1,299.99	SALE	1,199.97 set
T66584 Portable 9 Target Set	3,550.99	SALE	3,449.97 set

Franklin® Disc Golf Target Set

Ideal beginner/elementary target.

Easy to build frame design sets up in seconds! Unique umbrella design lets you set it up on nearly any surface and play.

Set includes: foldable target, 3 golf discs (1-RT 160 gm driver, 1-RT 160 gm mid-range disc, 1-RT 167 gm putter), carrying bag. Dimensions: 25.5"W x 52.5"H.

16390.....	\$74.99 set
16391 3-Target Set.....	209.99 set



BOWS/ARROWS

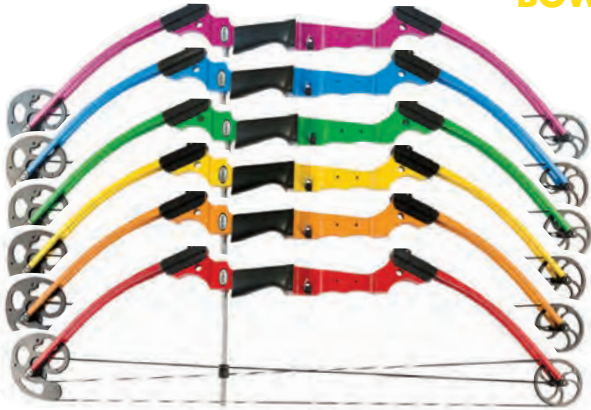

Genesis® Bows

Official bow of the National Archery in the Schools Program!

One cam design, lightweight, durable construction and adjustable 10-20 lb. Ideal for multiple ages 9 through adult. Easy to shoot with 15"- 30" draw lengths. Mini Bow weighs 2 lbs. with a 6-12 lb. draw weight for ages 5-8. Colored bows available for right hand shooters.

- 31066 Black Right Hand \$169.99 ea.
- 31067 Black Left Hand..... 169.99 ea.
- 31068 Mini Bow Right Hand..... 169.99 ea.
- 31069 Mini Bow Left Hand..... 169.99 ea.
- 31058 6 Color Right Hand Shooter Pack 979.99 set
- Genesis® Bow Specify Color-Right Hand-only 169.99 ea.

Red	Orange	Yellow	Green	Blue	Purple
31060	31061	31062	31063	31064	31065



Bear Archery® Youth Flash Recurve Bow

Ambidextrous riser for left- and right-handed shooters.

The integrated Whisker Biscuit Arrow Rest® – the safest rest in the archery industry – and sight pin are helpful in learning how to shoot. The Flash features a draw length range of 16 to 24 inches, a 5 to 18 lb. peak draw weight, and a brace height of 7". The let off is 60%. Includes: bow, two Safetyglass™ arrows, arrow quiver, finger rollers, and armguard. 47 inches long. Recommended ages 11 & up.

- 31110 Red..... \$44.99 ea.



Bear® Youth Composite Bows

Excellent bows for institutional use. Beginner bows feature ambidextrous riser for left or right hand use and durable composite limbs.

- 31029 Wizard 44" Ages 5-10 . \$18.99 ea.
- 31030 Crusader 51" Ages 9+... 26.99 ea.
- 31031 Titan 60" Ages 12+ 46.99 ea.
- 31032 Firebird 60" Ages 12+... 49.99 ea.



Bear® Bullseye X Bow

A Take-Down bow designed for older, more experienced children! Bow is made from a hardy, lightweight multi-laminate. Riser offers sight and arrow rest mounting holes. Fits right handed archer's only. 62"L with a 30 lb. draw wt.

- 31109..... \$111.99 ea.

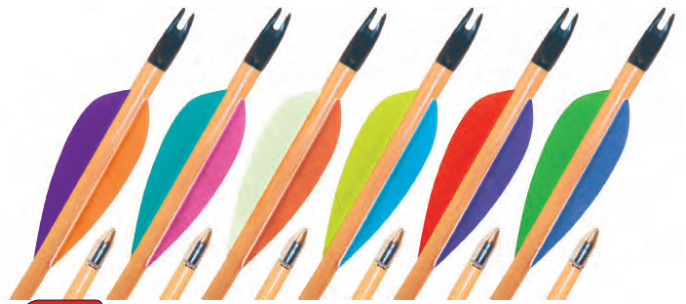

NEW

Hardwood 5/16" Target Arrows

Popular for youth archery programs using traditional bows.

Shafts are wood-grain with 3" parabolic feathers, snap-on nocks & crimped-on steel target points. For bow weights up to 35 lbs. Choose between 2 lengths.

- 31026 28" Pack of 72..... \$269.99 pk.
- 31027 30" Pack of 72..... 269.99 pk.



1/4" Fiberglass Arrows

Spined for bow weights of 25 lbs.

2 1/2" vinyl fletching, glued on vane and crimp on target point. Pack of 72.

- 31205 28".....\$219.99 **SALE \$199.97 ea.**
- 31206 30".....219.99 **SALE 119.97 ea.**



Classic Fiberglass Arrows

Spined for bow weights of 40 lbs.

3" vinyl vanes, fiberglass shaft, crimp on target point.

- 31240 28" Set of 12..... \$49.99 dz.
- 31241 30" Set of 12..... 49.99 dz.
- 31242 28" Pack of 72..... 228.99 pk.
- 31243 30" Pack of 72..... 228.99 pk.



Genesis® Aluminum Arrow

For use with Genesis® Bows.

Official NASP arrows. Assembled with Genesis 1820 shafts, Version 2 target points, AAE G-Nocks and Arizona Elite Plastifletch vanes. Set of 12.

- 31071 30" \$99.99 **SALE \$86.97 dz.**

TARGETS

HybriMAT™ Target

Lightweight, inexpensive, easy to maintain and long lasting!

Excellent target choice for your youth archery programs. This target mat will take tens of thousands of shots, then simply replace the inexpensive foam core which is backed by the compression BallistiCore center. Made from a hybrid system of laminated foam backing with 3 piece construction. The target base measures 34" x 34" x 10" deep with a replaceable 20" large core, constructed with 4" heat bonded laminated foam and a 10" diameter small core which is made of solid foam with BallistiCore backing.

- X31055 Complete 34" x 34" x 10" Target; 32 lbs. \$254.99 ea.
- X31056 Replacement 20" Large Core..... 40.99 ea.
- X31057 Replacement 10" Small Core 28.99 ea.



Ethafoam Target

Our most popular target.

Constructed of wound ethafoam. Heat bonded and resistant to wear weather and insects. Self healing. Cart sold separately. Call for freight quote- our regular shipping policy does not apply to 48" C39094.

- X31049 24" Target \$71.99 ea.
- X31013 36" Target 164.99 ea.
- C39094 48" Target 216.99 ea.

Free Standing Target Mat

A fast set up target.

Solves the problem of additional storage for stands by having a flat surface on the bottom of the round target. Made from layers of ethafoam, heat bonded for strength and durability and is 12" thick to last longer. A 36" round target with four color hang on face target and built in carry handle to relocate quickly and easily.

- X31015 \$299.99 SALE \$284.97 ea.



School Practice Cube

Freestanding, lightweight and durable!

Easy arrow removal with 4 target faces to use. Use with compound bows up to 450 FPS. Easy to transport with built in handle. Long lasting. Excellent value. Measures 21" x 21" x 21".

- X31078\$99.99 ea.

EZ Target

Replace your straw targets!

Easy to setup, easy to store, this new design foam target is bug proof, waterproof and long lasting. Made from closed cell foam to absorb repeated arrow impact and easy arrow removal. Includes stand, weighs only 9.5 lbs. and measures 36" x 36" x 4".

- X31017\$112.99 ea.



Square Target Faces

Square target faces are an inexpensive way to start your archery program.

Use nails with large washers or something similar to attach these target faces to anything; hay stacks, stuffed cardboard boxes, etc. The Glass cloth has tear resistant polyspun fibers and will not tear like paper faces.

- 31001 Glass cloth 36"\$13.99 ea.
- 31002 Glass cloth 48" 21.99 ea.

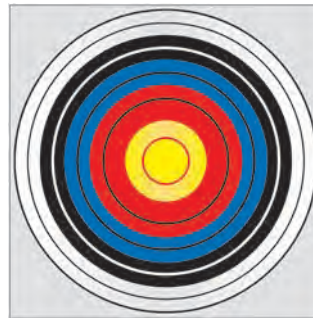

Round Skirted Target Faces

Two grades of faces.

The Glass cloth is a long lasting weather resistant face made of polyspun fibers. The Glass Flex is a much more durable fabric with more tear resistant fibers for longer wear. Both are slip-on and skirted, and are excellent for institutional use.

- 31100 Glass cloth 24" \$22.99 ea.
- 31003 Glass cloth 48" 30.99 ea.
- 31004 Glass cloth 36"-40"..... 22.99 ea.
- 31005 Glass Flex 48" 37.99 ea.
- 31006 Glass Flex 36"-40" 30.99 ea.



NEW

Morrell NASP Eternity School Target & Face Kit

Commercial grade target is the official target for NASP competition.

Features an internal frame system and tilt proof stabilizing bar to prevent tipping. Casters for easy maneuvering. 80 cm FITA bullseye on the front. Back side is solid white. Measures 32"H x 33"W x 12"D. Weighs 65 lbs. Includes (2) target faces made of durable polypropylene with 4 easy hang grommets. Baseball and golf designs. Faces measure 26"L x 26"W.

- X66798 Eternity Target w/ 2 Faces \$214.99 set
- X31111 Eternity Target only..... 209.99 ea.
- 66799 Baseball Target Face 6pk..... 74.99 pk.
- 66800 Golf Target Face 6pk..... 74.99 pk.
- 31112 Baseball Target Face Single..... 13.99 ea.
- 31113 Golf Target Face Single 13.99 ea.

ARCHERY ACCESSORIES



NEW

Essentials Youth Archery Kit

For up to 12 students.

Includes: Multipurpose Cart 46"H x 29"W x 30"D, (6) 51" Crusader Bows, (6) 60" Firebird Bows, (1) 28" Hardwood 5/16" Arrows 72 pk., (1) 30" Hardwood 5/16" Arrows 72 pk., and (12) Outdoor Quivers. Bows feature ambidextrous risers and composite limbs. Arrows feature 3" parabolic feathers, snap-on nocks & crimped-on steel target points. Quivers are made of steel and stick into the ground.

X66801 \$1,199.99 set

Multi-Purpose Cart

Ideal for archery!

Keep all of the gear in one place. Constructed of 1" powder coated steel tubing with a heavy duty polyester bag. Smooth wheels for easy transport. Measures 46"H x 29"W x 30"D; weighs 29 lbs.

X31083 \$164.99 ea.



Outdoor Quivers

Keeps arrows organized while target shooting.

Steel construction that sticks into the ground to keep arrows safe, visible and convenient.

31033 \$8.99 ea.



Gloves

Economical, scientifically designed back and finger tips.

Velcro closure.

31098 Medium \$6.99 ea.

31099 Large 6.99 ea.



Armguards

Polyethylene armguard designed for institutional use. One size fits all.

31035 \$5.99 ea.



Archery Cart Kit

All in one kit has everything you need!

The 53"L x 25"W x 28.5"H cart is made from 1" O.D. 18 gauge steel tubing with powder coat finish, weather resistant zinc plated hardware and 6" heavy duty molded casters. Kit contains: 3-Ethafoam 36" targets, 3-Glassflex® 36" target faces, 3-tripod target stands, 3-Titan 60" bows with 25-30 lbs. draw weight, 3-Scout 60" bows with 30-35 draw weight, 72-SafetyGlass™ 28" arrows, 6-armguards, 3-medium and 3-large shooting gloves, 3-ground quivers and a manual. Ships by truck.

T31039 \$1,399.99 **SALE \$1,349.97 set**



Archery Target Stands

Holds targets in place!

Steel tube construction with powder coat finish.

Tripod stand has cushioned feet for indoor use.

X31023 Wheeled Target Stand- for use with 36" & 48" targets \$84.99 ea.

X31024 Tripod Target Stand- for use with 24" & 48" targets 72.99 **SALE 59.97 ea.**

Recurve Youth Bowstrings

Institutional quality braided strings.

Double loop available for specific bow sizes and single loop for bows up to 66" in length.

31084 40" Double Loop 5.99 ea.

31085 50" Double Loop 5.99 ea.

31086 60" Double Loop 5.99 ea.



Nylon Archery Nets

Make your archery range safer!

Nylon net limits arrow loss and breakage. Bound top and grommet holes spaced 12" apart for simple set up behind your targets.

Not recommended for over 30 lb. draw weights.

X31226 9'L x 10'H \$319.99 ea.

X31227 18'L x 10'H 649.99 ea.

X31228 30'L x 10'H 949.99 ea.

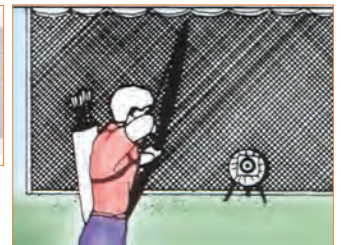



NEW

ZONE 5 Gallon Bucket Drum Set

For classes of up to 24 students.
Heavy duty plastic buckets with handles.
The red and blue buckets do not include lids. The yellow buckets come with lids.

Components:

- (8) 5 gal. Red Buckets
- (8) 5 gal. Blue Buckets
- (8) 5 gal. Yellow Buckets w/ Lids
- 16" Drumsticks – 24 pairs

66811 \$349.99 set



SPORTS HEALTH Fitness Ball & Stick Pack

Keep the beat and receive an amazing workout!

Create high energy classes to develop rhythm, burn calories and relieve stress. Each pack contains 24 – 25" fitness balls with feet for stability, and 24 pairs of 16" long drumsticks.

66742 Ball & Stick Pack \$449.99 pk.
17230 16" Drumsticks - 6 Pairs 24.99 pk.



NEW

ZONE Small Bucket Drum Set

For classes of up to 36 students.
Made of a heavy duty vinyl resin and standing 8.5" high and 8" diameter.

Components:

- (9) 8.5" Red Buckets
- (9) 8.5" Blue Buckets
- (9) 8.5" Green Buckets
- (9) 8.5" Yellow Buckets
- 16" Drumsticks – 36 pairs

66812 \$239.99 set



Dancing Scarves

Brightly colored with hemmed edges.

Designed for versatility and durability, these scarves can be used to highlight smooth movement and flowing rhythmic dance routines. Measures approximately 16" x 16".

15219 Set of 12 \$13.99 SALE \$9.97 set
15077 School Pack (108 pcs.) 135.00 SALE 88.97 set



ZONE 16" Wood Drumsticks

Solid wood construction.
Each pack includes 6 pairs of sticks constructed from one piece solid wood.
17230 \$24.99 pk.



Dancing Ribbons

Get your students dancing!

Also available are 72" ribbons attached to the same 9" handle. A more suitable length for upper elementary. Set of six, one of each color.

15050 SET OF 6 36" Ribbons \$14.99 SALE \$13.97 set
15051 SET OF 6 72" Ribbons 14.99 SALE 13.97 set

Deluxe Rhythm Stick Set

Top quality, painted wood sticks!
Use to develop rhythm and listening skills, coordination and perceptual motor skills. Set of 10 sticks measure 14" in length and 1/2" diameter.
15037 \$15.99 set SALE \$12.97 set



SPECIALTY ROPES



ZONE Ball Hop

An ankle jump rope.

With the unique handcuff ring to fit any foot, just swing the ball around, jumping with the other foot as the ball returns. Teaches eye-foot coordination and balance. A super tough plastic ball attached to a 17" speed rope. Speed channel located in ankle cuff allows for cord length change and speed of the ball.

15002 SET OF 6 \$24.99 SALE \$18.97 set



Ball Hop II

Puck design for improved rotation!

Designed with the 5.75" diameter open and shut "handcuff ring" for greater play. The ring snaps into place and stops from sliding off or having to remove shoes to get it on. ! Ring is attached to 22" long vinyl cord and plastic puck. Adjust cord length with the speed channel.

12007 SET OF 6 \$26.99 set



ZONE Twirl 'N' Jump

It's a one handed jump rope!

A rope jumping activity where the twirler, or 1 or 2 more can jump in! A slight circular motion on the 31" long baton gets the rope and ball going around in circles on the ground. Sold in a set of 6.

13009 SET OF 6 \$38.99 SALE \$29.97 set



NEW

Monkey Business Bungee Jumper

Brings the springy fun of "pogoing" to younger children.

Perfect for kids who have not yet developed the motor skills and balance to use a traditional pogo stick. Features a squishy foam base with a tethered handle. Measures 21" tall from the base to the handle. Ages 6+. Weight limit 250 lbs.

13090 \$22.99 ea.



Starter Jump Class Pack

An assortment of items to get a whole class jumping!

This pack has a variety of equipment to keep an entire elementary class trying different types of jumping activities.

Contents:

- | | | | |
|-----------|-------------------------------|-----------|------------------------------|
| 1 st. (6) | 15002 Ball Hops | 1 st. (6) | 13009 Twirl-N-Jump Batons |
| 12 ea. | 12041 8' Segmented Jump Ropes | 2 pr. | 12013 16' Double Dutch Ropes |
| 2 pr. | 13039 Jump Bands | 1 ea. | 36109 Mesh Storage bag |

66144 \$129.99 pk.



My First Flybar

Ideal for developing hand eye coordination, balance and strength!

Made from durable soft foam with soft handles and bungee cord. Squeaks when you hop. Maximum weight capacity 250 lbs.

13157 \$16.99 ea.

13158 Pack of 6 \$101.90 SALE 92.97 pk.

TINIKLING

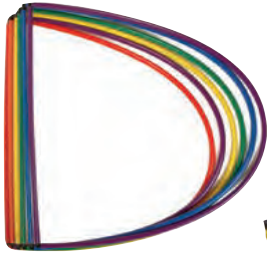

Hoop Jumpers™

A confidence building jumper!

Made from flexible, no-kink polyethylene, these jumpers snap together quickly and you can use them in many different activities! Use as a jumper, snap into Multi-Domes™ for crawl over/under or targets, attach the straight bar separately to cones and use as a hurdle! Sold in a set of 6, one of each color.

15135 SET OF 6 \$64.99 set



Jump Bands

Develops coordination, rhythm, teamwork and good social skills!

These official Jump Bands have loops at each end to wear around the ankles and the "pole holders" now can jump up, down, in and out to increase the jumping challenge to players! Bands sold in pairs in assorted colors. Other components available are the Jump Band DVD which presents excellent jumping activities and Activity Cards which includes 12 sheets of illustrated steps. The Jump Band Starter Kit includes: 6 assorted pairs of bands, Jump Band DVD, Activity Cards and a CD with 10 jumpy sections.

13039 Jump Bands- assorted colors \$22.99 SALE \$18.97 pr.

39024 Jump Band DVD- 6 min..... 15.99 ea.

13040 Activity Cards- set of 12 7.99 set

13031 Jump Band Starter Kit- 6 pr. of bands, DVD, cards & CD 127.99 set



Tinikling Poles with Handles™

Takes away the fear of pinched fingers!

The L shaped design eliminates fingers near the floor and the need for slides or crossbars. These poles are made from sturdy impact resistant plastic and adjust in length from 5' to 8' without tools.

X15086 \$94.99 pr.

DOUBLE DUTCH



Double Dutch Rope

The ultimate challenge in jump roping.

Available in cotton ropes (one continuous rope) or PVC vinyl rope which comes in a pair with looped ends for handles.

12011 12' Vinyl..... \$4.99 pr. 12037 32' Cotton Rope \$10.49 ea.

12013 16' Vinyl..... 5.99 pr. 12038 48' Cotton Rope 14.99 ea.

12014 30' Vinyl 8.50 pr. 12039 64' Cotton Rope 19.99 ea.

Double Dutch Jump Rope Packs

Ideal for large classes!

Your choice of vinyl or cotton packs.



Vinyl Double Dutch Jump Rope Pack

Includes:

3 pr. 12011 12' Rope

6 pr. 12013 16' Rope

3 pr. 12014 30' Rope

12132 Assorted Colors \$69.99 pk.

Cotton Double Dutch Jump Rope Pack

Includes:

3 ea. 12037 32' Rope

3ea. 12038 48' Rope

1ea. 12039 64' Rope

12136 \$89.99 pk.



Chinese Jump

Extremely popular with the young and young at heart.

Elastic ropes are safe for use

in a variety of games and activities. Helps build coordination, endurance and agility. 40 minute DVD features 11 fun and easy to learn games.

12035 8' Ropes \$28.99 dz.

12036 16' Ropes 31.99 dz.

39192 Chinese Jump Rope DVD 40 minutes 17.99 ea.



JUMP ROPES

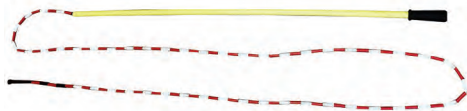

NEW

Sidewinder™ Rope Activity

Involve the entire class with one piece of equipment. The Sidewinder is a combination pole and 14' segmented jump rope with a weighted end. It can be pulled or rotated around the gym floor in various patterns while students jump over it.

12172 \$54.99 ea.



ZONE Whirl-O-Rope

A great jumping trainer! Ideal for limited spaces or novice jumpers learning proper technique. Develops rhythm, timing and provides a great aerobic workout. Plastic handles, vinyl cord and plastic balls to improve rotation. Sold as a pair or a class pack of 24 pairs.

12049 Whirl-O-Rope \$7.99 **SALE \$5.97 pr.**
 12058 Class Pack- 24 pairs 191.76 **SALE 139.97 pk**



Jump Rope HotSpots®

Membrane printed graphics won't scuff or tear! New wear resistant thermoplastic elastomer spots measure 8.5" in diameter. Each disc has a detailed explanation of how to perform drill with supporting graphics. Just spread them out and your stations are set. Includes an activity guide.
 21139 Set of 12 \$44.99 set



"Safe" All-Rope Jump Ropes

Children will love the softness. These nylon braided jump ropes are perfect for all ages. They are knotted on each end for an easy grip. Make additional knots to adjust sizes. Sold in a set of 6, one of each color. Great addition for your jump rope program.

12062 SET OF 6 7' \$13.99 set 12065 SET OF 6 10' \$16.99 set
 12063 SET OF 6 8' 14.99 set 12066 SET OF 6 16' 22.99 set
 12064 SET OF 6 9' 15.99 set 12067 SET OF 6 32' 38.99 set



Elementary Safe Jump Rope Pack

36 jump ropes!
 Includes:
 4 sets 12062 7' Safe All-Rope Jump Ropes sets of 6
 2 sets 12063 8' Safe All-Rope Jump Ropes sets of 6
 12129 \$69.99 pk.

Middle School Safe Jump Rope Pack

24 jump ropes!
 Includes:
 3 sets 12063 8' Safe All-Rope Jump Ropes sets of 6
 1 set 12064 9' Safe All-Rope Jump Ropes sets of 6
 12130 \$49.99 pk.



Nylon Jump Ropes

Heavyweight rope with wood handles.
 12026 7' \$2.75 ea.
 12023 8' 2.89 ea.
 12024 9' 3.20 ea.
 12025 16' 3.49 ea.

SEGMENTED ROPES



ZONE X-Heavy Plastic Segmented Ropes

Now with a heavier gauge plastic and rope.

Unbreakable plastic sections on an extra heavy nylon rope. This jump rope is one of the most popular available because of its even weight distribution making a slower, easier rope for jumping. Color coded. 3 Year Guarantee!



- 12001 6' White Handles - Green/White Segments \$2.50 ea.
- 12040 7' White Handles-Blue/Red Segments 2.70 ea.
- 12041 8' Blue Handles-White/Blue Segments 2.80 ea.
- 12042 9' Red Handles-White/Blue Segments 2.99 ea.
- 12043 10' Black Handles-Red/White Segments 3.30 ea.
- 12044 16' Red Handles - Red/White/Blue Segments 4.99 ea.



ZONE Elementary School Jump Rope Pack

Our most popular elementary rope!

Includes:

- 36 ea. 12040 7' Plastic Segmented Ropes
- 12 ea. 12041 8' Plastic Segmented Ropes
- 12134 \$130.80 **SALE \$119.97 pk.**

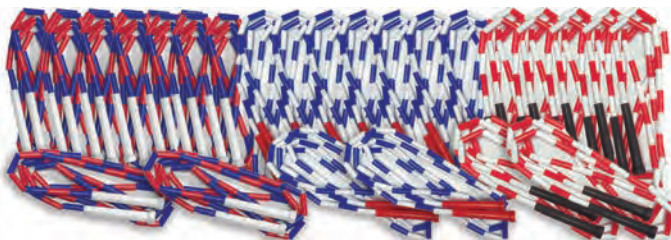

ZONE Middle School Jump Rope Pack

A favorite rope for 6th thru 8th grades!

Includes:

- 12ea. 12040 7' Plastic Segmented Ropes
- 24 ea. 12042 9' Plastic Segmented Ropes
- 12 ea. 12043 10' Plastic Segmented Ropes
- 12135 \$143.70 **SALE \$139.97 pk.**

WHICH JUMP ROPE IS RIGHT FOR YOU?

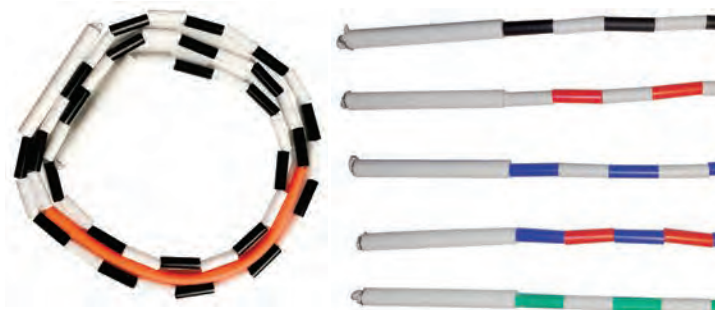

ZONE Beaded Tubing Ropes

Surgical latex tubing absorbs impact!

Latex tubing inserted in the bottom where the rope impacts the floor results in less wear and tear and longer rope life. The tubing absorbs the impact, stings a little less on the legs and is quieter than conventional beaded ropes.

- 12045 7' Black/White \$4.29 ea.
- 12046 8' Red/White 4.49 ea.
- 12047 9' Blue/White 4.99 ea.
- 12059 10' Blue/Red 5.49 ea.
- 12048 16' Green/White 6.99 ea.



Kanga Beaded Ropes

The highest quality segmented jump rope on the market!

With a slightly thicker, multi-weave nylon rope and near unbreakable plastic segments, these ropes have nice balance and will last.

Sold by the dozen.

- 12101 7' Red/White \$63.99 dz.
- 12102 8' Blue/White 66.99 dz.
- 12103 9' Green/White 69.99 dz.
- 12104 10' Yellow/White 74.99 dz.
- 12105 14' Red/White 120.99dz.
- 12106 16' Blue/White 126.99dz.



SPEED ROPES



ZONE Licorice Speed Ropes

An economical speed rope.

PVC vinyl cord with unbreakable plastic handles. Organize jump rope sizes and brighten up classes with a colorful look. Sold in a set of 6, one of each color. Sizes are identified by handle colors.

- 12071 SETOF6 6' Black Handles..... \$10.99 set
- 12072 SETOF6 7' Red Handles..... 11.99 set
- 12073 SETOF6 8' Yellow Handles..... 12.99 set
- 12074 SETOF6 9' Blue Handles..... 13.99 set
- 12087 SETOF6 16' Orange Handles..... 19.99 set



ZONE Adjustable Jump Ropes

Length changes in seconds to suit your size!

These 9' ropes can adjust down to any size quickly and easily- simply slide and move the rope within the two internal chambers! Soft and flexible, made from a slightly thicker PVC, these ropes have an unbreakable plastic handle. Sold in a set of 6, one of each color.

- 12091 SETOF6 \$17.99 set



Exer-Rope® Speed Jump Ropes

Same jump rope as used by Jump Rope for Heart.

One of the best speed ropes on the market. Constructed with plastic handles and a 2 color vinyl twist rope. Color coded for size. Sold in sets of 6.

- 12031 7' Orange Handle..... \$14.99 set
- 12032 8' Red Handle..... 15.99 set
- 12033 9' Green Handle..... 16.99 set
- 12034 10' Black Handle..... 17.99 set



Ball Bearing Speed Ropes

Smooth spinning, great grip!

Contoured ball bearing handle with licorice speed rope. Sizes are color coded for easy identification.

- 12060 SETOF6 8' Yellow Handle \$13.99 set
- 12061 SETOF6 9' Blue Handle 14.99 set
- 12069 SETOF6 10' Green Handle 15.99 set



Elementary Jump Rope Class Pack

For ages 6-11, includes 36 jump ropes, HotSpots® and DVD.

- Contents:
- 2 sets 12071 6' Licorice Speed Ropes- set of 6
 - 2 sets 12072 7' Licorice Speed Ropes - set of 6
 - 2 sets 12073 8' Licorice Speed Ropes - set of 6
 - 1 set 21139 Jump Rope HotSpots®
 - 1 ea. 39025 Fundamentals of Rope Jumping DVD

66273 \$139.99 **SALE \$124.97 pk.**



Middle/High School Jump Rope Class Pack

For ages 12 and up, includes 36 Exer-Rope® jump ropes, HotSpots® and DVD.

- Contents:
- 2 sets 12032 8' Exer-Rope® Speed Ropes- set of 6
 - 3 sets 12033 9' Exer-Rope® Speed Ropes - set of 6
 - 1 set 12034 10' Exer-Rope® Speed Ropes - set of 6
 - 1 set 21139 Jump Rope HotSpots®
 - 1 ea. 39025 Fundamentals of Rope Jumping DVD

66274 \$168.99 **SALE \$154.97 pk.**



SPORTS HEALTH Speed Ropes

Available in 3 lengths!
Relaxed vinyl rope straightens out quickly and twirls great.
Handles are contoured with ball bearings for smooth swivel.

SZ.	COLOR	EACH		6 PACK	
8'	BLACK	12169	\$9.99 ea. SALE \$4.97 ea.	12126	\$29.82 pk. SALE \$24.97 pk.
9'	RED	12170	9.99 ea. SALE 4.97 ea.	12127	29.82 pk. SALE 24.97 pk.
10'	BLUE	12171	9.99 ea. SALE 4.97 ea.	12128	29.82 pk. SALE 24.97 pk.

ROPE STORAGE

STORES UP TO 180 JUMP ROPES & 50 HOOPS!



Jump Rope & Hoop Cart

Stores up to 180 ropes and 50 hoops!
Made from strong structural plastic with non-marring casters, a low center of gravity to prevent tipping and simple assembly.
Measures 29" L x 19" W x 70" H.
X36016.....\$164.99 ea.



Double Bearing Speed Rope Set

Adjustable screws allow length change.
Made with a 3mm durable wire cable with a 15cm ergonomic handle with double bearing. 9' length.
12161 SET OF 6.....\$29.99 set



ZONE Multi-Use Wall Rack

Organize by size!
This convenient rack/holder will allow you to "untangle" the mess and hang jump ropes out of the way by size and type.
Steel rack is 2"W x 24"L. Five 12" pegs will hold 100 jump ropes. Mounting hardware included.
36172.....\$41.99 **SALE \$34.97 ea.**



Weighted PVC Jump Rope

Ergonomic handles for comfort!
Handles are a little over .5 lb. each to give a bit extra effort in training. PVC rope flies true with excellent rotation.
12117 9'.....\$16.99 ea.



Weighted Jump Ropes

Add an extra kick to your cardio workout!
Made of solid rubber with foam covered swivel ball bearing handles. All ropes are 9' long.
12082 1 lb. Green.....\$24.99 ea. 12084 3 lbs. Yellow.....\$41.99 ea.
12083 2 lbs. Orange.....28.99 ea. 12085 4 lbs. Blue.....47.99 ea.

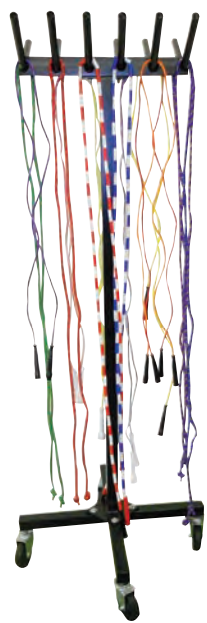

Steel Jump Rope Cart

Extremely well built!
Steel cart has twelve 8" posts to store up to 100 jump ropes. Constructed of square powder coated steel with rubber casters. Use it for resistance tubing as well!
Cart measures 26" L x 19" W x 65" H.
X15893.....\$129.99 ea.

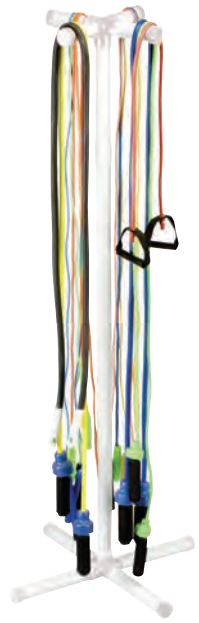

Jump Rope Tree

Holds over 100 ropes!
Made from strong 1.75" diameter plastic tubing, assembles in minutes. Allows any size rope. Measures 20" L x 20" W x 64" H.
X36017.....\$49.99 ea.

PARACHUTE PLAY



The Zone Parachute Games Toss Kit

A fun packed set to keep the entire class moving. This toss kit includes dozens of fun pieces plus a book and DVD loaded with games. All you need to bring is a parachute.

- Contents:
- Set of 12 – 15219 16" Juggling Scarves
 - Set of 12 – 10524 2.75" Fluff Balls
 - Set of 6 – 10522 18" Heavyweight Beach Balls
 - Set of 6 – 10520 9" Colored Whiffle Balls
 - Set of 6 – 10582 PX-4 Bounce Free Balls
 - Set of 6 – 26020 Sea Critters Bean Bags
 - Set of 5 – 17154 MiniFish Footballs
 - Pk. of 144 – 10216 9" Latex Balloons
 - Each – 17171 22" Hav-A-Ball™ Volleyball
 - Each – 10240 2.25" Streamer Ball
 - Each – 38018 Parachutes Games Book/DVD
- ⚠ CHOKING HAZARD (6) - BALLOON. Not for under 8 yrs.*

66808 (Parachute sold separately).....\$229.99 kit

Parachute Games

Book features 59 new games plus a DVD with 28 activities!

Use minimal equipment and involve a maximum of participants of all ages and skill levels. Grades K-8.

38018 Book and DVD \$28.99 ea.

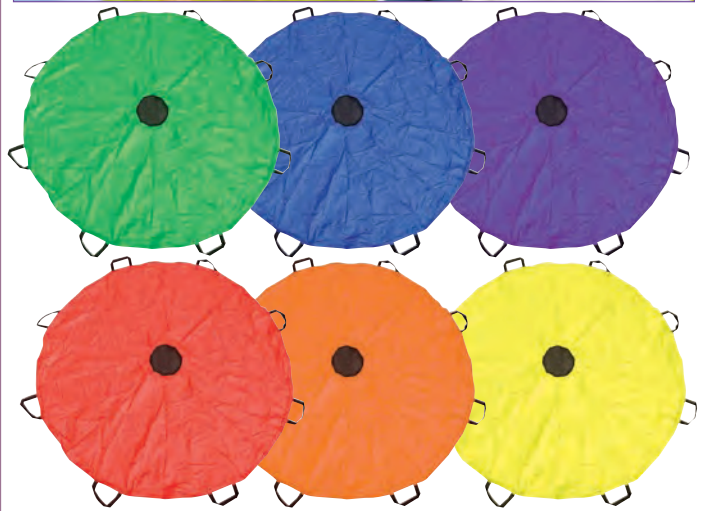

Solid Color Parachute Set

Great for team play!

These 6' parachutes are made from 70 denier nylon with over locked seams and reinforced, wrapped handles. Handles are attached to 1" nylon webbing around the entire perimeter of the parachute. Virtually eliminates torn handles.

16081 SET OF 6 8 handles \$79.99 set

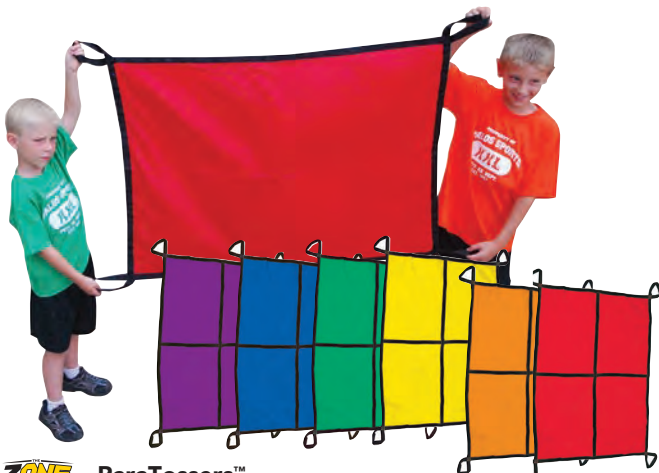

ZONE ParaTossers™

Toss and fling foam balls, rubber chickens and more!

Create fast moving tossing games for partners or teams. Pass balls from chute to chute, use for oversized team relays, or play a wacky version of kickball! Parachutes measure 48" L x 32" W and are made from durable nylon with a 1" wide outer reinforced band and looped corners.

Measures 48" L x 32" W. Sold in a set of 6, one of each color. 16220 SET OF 6 \$54.99 SALE \$45.97 set

*Full CHOKING HAZARD descriptions on page 355.



Team Connect-A-Chute™

Create multiple chute configurations!

6 rectangular chutes, 2 chutes with holes and 4 corner sections offer endless opportunities for team activities! Each section features handles plus hook and loop fasteners to connect. Connect them together to create a runway to transfer objects from end to end. Connect a hole and corner to heighten the challenge or form a grid for a rectangular parachute. Includes activity guide.

16186..... \$98.99 set

BEST PARACHUTES FOR YOUR MONEY! 1" HEAVY NYLON PERIMETER WEBBING & 70 DENIER NYLON BODY.



Heavy Duty Standard Parachutes

An affordable quality parachute with reinforced handles.

All parachute handles are attached to a 1" nylon webbing that runs around the entire perimeter of each parachute which virtually eliminates torn handles. One of the most flexible and popular tools available to Special Ed. or Adapted PE instructors. These brightly colored parachutes are fun and exciting for all ages. Constructed with quality 70 denier nylon. All seams are over-locked and handles are wrapped and reinforced.



Size	Handles	Item	Price	Sale
6 Feet	8	15487	\$18.99 ea.	\$14.97 ea.
12 Feet	12	15488	36.99 ea.	28.97 ea.
20 Feet	20	15489	82.99 ea.	69.97 ea.
24 Feet	24	15490	102.99 ea.	88.97 ea.
30 Feet	30	15491	144.99 ea.	128.97 ea.
35 Feet	30	15587	192.99 ea.	178.97 ea.
45 Feet	32	15588	299.99 ea.	266.97 ea.

No Handle Parachutes

No more fighting over who gets to hold the handles!

Made from durable 210 rip stop nylon with reinforced seams for long lasting play. Available in 12', 24' and 30' diameters. Includes carry bag.

- 15594 12' Parachute \$60.99 ea.
- 15595 24' Parachute 146.99 ea.
- 15596 30' Parachute 224.99 ea.



HOOPS

HOOPS!

AVAILABLE IN RAINBOW COLORS



Skinny No-Kink™ Hoops

1/2" the diameter and half the weight of standard hoops!

Easier for younger, smaller students to spin and twirl. Their low profile make them the perfect quick step run through hoops! 2 of each color.

- 14028 SET OF 12 24" \$40.99 dz.
- X14029 SET OF 12 30" 44.99 dz.
- X14030 SET OF 12 36" 50.99 dz.



Standard Hoops

Three sizes at an affordable price.

Lighter weight but still extremely popular for a number of hoop activities. 2 of each color.

- X14019 SET OF 12 24" \$44.99 SALE \$37.97 dz.
- X14020 SET OF 12 30" 49.99 SALE 43.97 dz.
- X14034 SET OF 12 36" 58.99 SALE 49.97 dz.



Deluxe Hoops

A traditional product for modern rhythmic gymnastics, exercise and fun.

An excellent quality hoop shipped in dozen packs: 2 of each color.

- X14015 SET OF 12 24" \$60.99 SALE \$52.97 dz.
- X14016 SET OF 12 30" 64.99 SALE 57.97 dz.
- X14017 SET OF 12 36" 71.99 SALE 63.97 dz.



No-Kink® Hoops

The most durable hoop made!

Hoops will hold up to heavy classroom abuse.

No-Kink Hoops cost more initially, but over the long run they will outlast traditional hoops making it a hassle free investment. 2 of each color.

- X14013 SET OF 12 24" \$61.99 dz.
- X14014 SET OF 12 30" 63.99 dz.
- X14018 SET OF 12 36" 68.99 dz.



Flat Hoops

Durable injection molded flat hoops are great for a variety of uses.

One piece design means no joints to break and because they are flat students will not trip over them. Use them for marking stations, agility drills and athletic training. Sold in a set of 12.

- 14036 SET OF 12 14" Flat Hoop \$38.99 SALE \$29.97 dz.
- 14037 SET OF 12 20" Flat Hoop 48.99 SALE 39.97 dz.
- 14038 SET OF 12 24" Flat Hoop 52.99 SALE 45.97 dz.



HotSpot™ Hoops!™

All you need are some hoops!

Place these 8.5" diameter spots on the floor and have participants perform the featured hoop exercise. Great for developing strength, flexibility, social skills, and more. Set includes 12 molded vinyl spots and instruction guide. Challenging for all ages!

- 21172 \$44.99 set



HOOP ACCESSORIES



ZONE Foam Dual Hoop Holders

Able to hold flat hoops and standard hoops at the same time! Choose to set up one flat, one standard, or two hoops at once. Two separate channels make these holders a more versatile option versus typical holders. Hoops not included.

17280 Set of 6 pairs \$89.90 **SALE \$27.97 set**

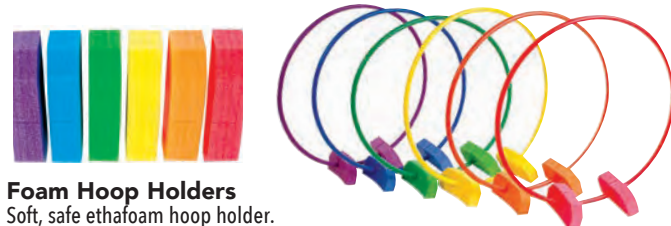

Foam Hoop Holders

Soft, safe ethafoam hoop holder. Can also hold the hoop horizontally on the floor so they can experience stepping and jumping in and out. Hoop holders are made of strong Ethafoam that the hoop slips into. Hoops not included.

14003 SET OF 6 2 of each color \$29.99 set



Multi-Domes™

New design now holds any diameter hoop including Skinny No-Kink Hoops! Now with 4 perimeter holes for dozens of new over, under and through obstacles. Either style is sold in a set of six, one of each color. Hoops not included.

X13162 SET OF 6 6" Multi-Domes™ Jr. \$69.99 set

X13057 SET OF 6 9" Multi-Domes™ 105.99 set

X13098 9" Multi-Domes™ Assorted Colors 18.99 ea.



HoopKlipperz™

Create new possibilities for hoops! A unique design allows hoops and wands to be held with more stability and in more positions than ever before. Hoops fit snugly into "C" clips which have rubber-like inserts that further grab the hoop. Sold in a set of 6.

14000 SET OF 6 \$48.99 **SALE \$42.97 set**

HOOP STORAGE



ZONE Hoop Holder

Organize and/or transport. Made from nylon with web strap handle and Velcro® closure. Measures 7.75" L. Hoops not included.

54207 \$6.99 **SALE \$4.97 ea.**



Hoop Storage Bags

Holds up to 12 hoops! An ideal way to transport and store your hoops! Made from rip stop nylon with zipper closure.

14031 24" \$19.99 ea.

14032 30" 22.99 ea.

14033 36" 25.99 ea.



Wall Hoop Holder

Neatly organizes hoops. Steel rack is 2"W x 24"L. Five 12" long pegs hold approximately 50 hoops depending on the size. Mounting hardware included.

36172 \$41.99 **SALE \$34.97 ea.**



STORES UP TO 180 JUMP ROPES & 50 HOOPS!

Jump Rope & Hoop Cart

Stores up to 180 ropes and 50 hoops! Made from strong structural plastic with non-marring casters, a low center of gravity to prevent tipping and simple assembly. Measures 29" L x 19" W x 70" H. Hoops and ropes not included.

X36016 \$164.99 **SALE \$149.97 ea.**



Hoop Cart

Holds up to 100 hoops! Organize hoops on multi-level hooks to maximize storage capacity. Cart is made from impact resistant, heavy duty plastic with 10" diameter rear wheels and 3" diameter swivel casters. Measures 26" L x 26" W x 47" H. Hoops not included.

X36015 .. \$134.99 **SALE \$119.97 ea.**



#1 SELLER

BOWLING BALLS



ZONE Vinyl Bowling Balls

Realistic looking with vibrant colors and marble patterns.

Made with one piece seamless vinyl construction, and two sets of finger holes on opposite sides to fit a variety of hand sizes. Latex free, safe for all floors.

- 16394 3 lb. Electric Lime/Yellow Ball \$29.99 ea.
- 16395 4 lb. Electric Orange/Yellow 37.99 ea.
- 16396 5 lb. Electric Blue/Yellow 48.99 ea.



ZONE Bowling Sets

A budget friendly set that remains fun and vibrant.

Each bowling set contains one Zone bowling ball and one set of Zone sand weighted 15" plastic pins. Balls are made of one piece seamless vinyl with 2 sets of finger holes on opposite sides to fit a variety of hand sizes. Choose from 3 weights.

- 15911 3 lb. Ball & 10 Pins \$94.90 **SALE \$72.97 set**
- 15912 4 lb. Ball & 10 Pins 104.90 **SALE 78.97 set**
- 15913 5 lb. Ball & 10 Pins 110.90 **SALE 83.97 set**
- 15078 Set Up Sheet Only (not included in sets) 7.99 ea.



Standard Rubber Bowling Ball

A hard rubber hollow ball.

The rubber balls have two sets of finger holes, choose either a 2.5 lb. (2-finger) or 5lb. (3 finger) ball.

- 15048 2.5 lb. ball w/ 2 finger holes \$29.99 ea.
- 15049 5 lb. ball w/ 3 finger holes 51.99 ea.

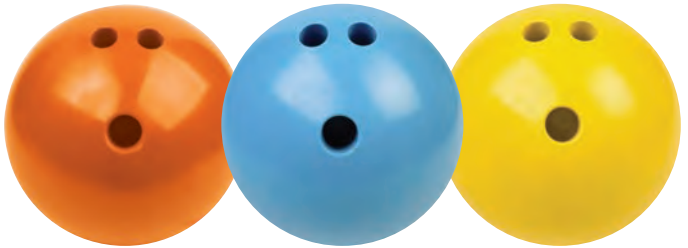

PVC Rubberized Bowling Balls

Roto molded design with one set of 3 finger holes.

An excellent value ball. Easy to grip with 3 weights for all ages.

- 15890 3 lb. Orange Ball \$29.90 ea.
- 15891 4 lb. Blue Ball 39.99 ea.
- 15892 5 lb. Yellow Ball 45.99 ea.



RhinoSKIN Ultra Foam Bowling Ball

A revolutionary weighted bowling ball!

Unique polyurethane foam construction with a tough outer skin that resists peeling, splitting and moisture. Excellent low bounce, smooth rolling weighted ball. Designed with 2 sets of finger hole patterns for a perfect fit for all hand sizes.

- 15279 1 lb. Red \$24.99 ea.
- 15280 2.5 lb. Blue 36.99 ea.
- 15281 5 lb. Green 56.99 ea.

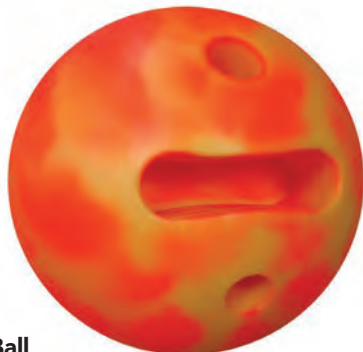

ZONE Adaptive Bowling Ball

Easy to grip and roll.

Special finger slot and multi-hole design makes this ball easier for special needs students to hold and release. Constructed of unbreakable vinyl. For indoor or outdoor use.

- 17243 \$29.99 ea.

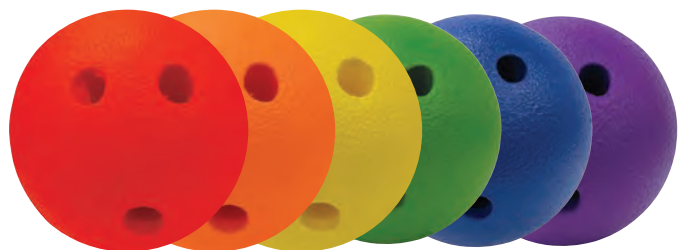

PALOS RUFFSKIN Vinyl Coated Foam Bowling Balls

Lightweight vinyl coated bowling balls.

Made with durable dense foam with multiple finger holes and coated with a long lasting polyurethane cover.

- 15387 Assorted colors \$19.99 ea.
- 15380 SET OF 6 109.99 set

BOWLING PINS



Multi-Colored Bowling Pin Set

Add some color to your lanes or pin games!

Standard size weighted pins sold as a set of 10- 2 of each color: red, orange, yellow, green and blue. Includes set up sheet and score pad.

15367\$46.99 set



Foam Bowling Pin Sets

The most durable foam pins on the market!

These 14 oz. weighted pins have a plastic inner shell with a soft, virtually pick proof foam outer lining (cover not removable). Pins measure 15"H with a 4.75" diameter. Set of 10.

17181 60 Pin Pack- 1 set of each color \$ 479.90 SALE \$429.97 pk.

Red	Orange	Yellow	Green	Blue	Purple	Set
16180	16181	16182	16183	16184	16185	\$79.99



INCLUDES 6 MATCHING COLORED BAGS

ZONE Slim Bowling Pins

Thinner and taller than traditional bowling pins.

Create new configurations to challenge bowlers! Set includes 10 pins of each color with color coded storage bag: red, orange, yellow, green, blue and purple. Made from tough polyethylene with weighted bases. Measures 17" tall.

16175 6 color set \$149.99 set

ZONE Bowling Pins

The most affordable weighted pins on the market.

Sand weighted 15" plastic pins have a slightly thinner wall than our traditional pins yet still weigh about 10 ounces.

Set of 10 pins only.

15910\$64.99 SALE \$49.97 set



Foam Colored Bowling Pins

Now available in colors!

Soft, polyurethane foam pins won't clatter or echo in your gym! These 15" tall pins are sold in a set of 10, two of each color.

X15759\$54.99 set

Traditional Plastic Bowling Pin Sets

The premium quality bowling pins used in the industry.

Constructed of heavy duty, thick walled plastic, pins are 15" tall and weighted. Sets include 10 pins, set up sheet and score pad.

15047 Heavy Duty 6 oz. Pin Set \$43.99 set

15046 Heavy Duty 10 oz. Sand Filled Pin Set..... \$79.99 set

15078 Set Up Sheet only.....7.99 ea.



Foam Bowling Set

A soft and safe choice for beginners.

Durable polyurethane covering on both the pins and bowling ball makes them soft, safe and quiet! Set includes 1-8" bowling ball with multiple finger holes, 10- 8.5" pins and vinyl carry bag.

15173.....\$54.99 set

Foam Bowling Toss Targets

Virtually indestructible!

These can be used as bowling pins or as targets in any type of toss game. Their 4" diameter base allows them extra stability. Set includes 10-12" pins and 4 (6" dia.) flyer foam saucers.

15090\$83.99 set



ZONE Weighted Knock Down Targets

A colorful & fun alternative to the traditional white bowling pin.

These 9" targets are made with a durable foam rubber cover, with a weighted base to prevent easy tipping. The uses are endless. Use in capture the flag games, or as a fun alternative to bowling pins or relay batons.

17227 SET OF 6..... \$38.99 SALE \$27.97 set



BOWLING CLASS PACKS



6 Lane Bowling Pack

Set 6 lanes up fast and easy with this pack!

Includes a set of 6 RuffSKIN vinyl coated foam bowling balls and 6 sets of 10 foam bowling pins for a total of 6 balls and 60 pins. Includes 6 mesh carry bags.

17158 \$629.88 **SALE \$531.97 pk.**

**CHOOSE FROM
FOAM OR VINYL BALLS**



NEW ZONE Weighted Target Bowling Sets

A 9" tall, narrower, colorful alternative to the traditional white pin.

Made with a durable foam rubber cover and a weighted base to prevent tipping, The Zone targets add a new twist to bowling. Use for relays and targeting games as well. Foam Ball Set includes: Ruffskin Foam Bowling Balls (set of 6), Targets (10 sets of 6 - 60 total). Ruffskin balls are made with a durable polyurethane cover. Vinyl Ball Set includes: Zone 3 lb. Vinyl Bowling Balls (6), Targets (10 sets of 6 - 60 total). Zone Vinyl balls are seamless, one piece construction with 2 sets of holes for a variety of hand sizes.

66794 Foam Ball Set - Set of 6 Ruffskin Bowling Balls & 10 sets of targets **\$339.99 set**

66795 Vinyl Ball Set - Six 3 lb. Electric Lime/Yellow Balls & 10 sets of targets **499.99 set**

66809 Weighted Targets (only), Set of 60 - 10 of each color **269.99 set**



ZONE Bowling Class Pack

Everything you need for beginner bowlers!

Pack includes:

- 3 ea. 16394 3 lb. THE ZONE Bowling Balls
- 3 ea. 16395 4 lb. THE ZONE Bowling Balls
- 4 st. 15910 THE ZONE Weighted Bowling Pin Sets
- 4 ea. 15078 Pin Set Up Sheets
- 2 ea. 36210 Storage Bags

X66113 **\$509.80 SALE \$349.97 pk.**



In-School Bowling® Set

Everything you need to start teaching bowling skills to your students.

The 35 page teachers curriculum along with the instructional video offers a step by step teaching progression. The curriculum includes fun bowling games that reinforce math skills, spelling, adapted P.E. and language art skills along with motivating fitness activities that increase your heart rate and offer tips for advanced bowlers. The Deluxe package includes one heavy duty 20' x 40" carpeted bowling lane with pin layout template and realistic target arrows, 10 durable 15.5" PVC weighted pins, one 4 lb. rubber bowling ball, score pad, in-school educator kit, curriculum guide with 13 lesson plans, instructional video, and a nylon storage bag.

X15931 Deluxe Package; lane, pins, ball, curriculum, video, and storage bag **\$299.99 set**

X15158 Carpet Lane 20'L x 40"W; 20 lbs. **199.99 ea.**

X15159 Carpet Lane 30'L x 40"W; 30 lbs. **239.99 ea.**



4 Lane Bowling Pack

Everything you need for a fun bowling station!

Includes:

- 4 ea. 16395 4 lb. THE ZONE Bowling Balls
- 4 sets 15910 Bowling Pins
- 4 ea. X15290 Bowling Pin Backstop
- 4 ea. 15078 Set Up Sheet

X66406 4 Lane Bowling Pack **\$749.97 SALE \$749.97 pk.**



ZONE 2 Lane Pack

Quickly reset pins to keep the game moving!

Pack includes:

- 2 15910 THE ZONE Weighted Bowling Pin Sets
- 2 16395 4 lb. THE ZONE Bowling Balls
- 2 16 Pin Placement Pads
- 1 36210 Storage Bag

X66114 **\$322.90 SALE \$259.97 pk.**

ACCESSORIES



FOLDS DOWN FOR EASY STORAGE!



Bowling Pin Backstop

Keep your pins in place!

Save time setting pins up by keeping them corralled! This backstop is made from a .75" thick powder coated steel frame with honeybee pattern mesh netting and Velcro® attachment. Measures 48"W x 12"H. Folds for storage. Red only.

X15290 Bowling Pin Backstop.....\$94.99 SALE \$78.97 ea.

X15274 Backstop 4 Pack.....329.99 SALE 309.97 pk.

Bowling Lane

Lightweight, portable, easy to use and economical!

It simulates a real bowling lane and is perfect for bowlers of all ages. The lane is made of special plastic with a "memory" so it always lays flat. Dampness will not harm it and it can be rolled for compact storage. Pin placement dots and directional arrows attribute to the authentic bowling experience. Measures 42"W x 20'L. Pins not included.

15168.....\$112.99 SALE \$104.97 ea.

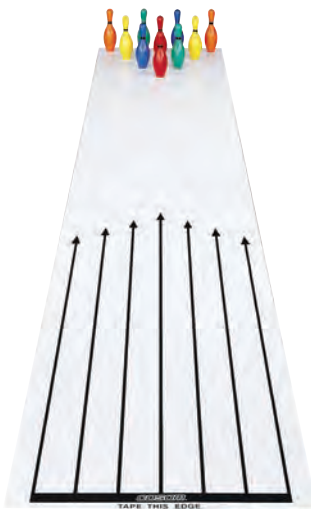

Pin Placement Pad

Quick and easy way to set up your lanes!

A heavy weight vinyl floor pad with silk screened graphics. Proper pin placement every time!

15009 54".....\$44.99 ea.

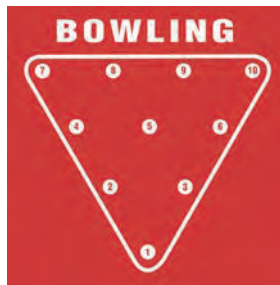

Set Up Sheet

Set pins exact- every time!

Cardboard form with vinyl coat has cutouts to show pin placement. Pins not included.

15078 40".....\$7.99 ea.



Aluminum Bowling Ramp

Make bowling fun for everyone!

Not only great for students in wheelchairs, but

for students with limited upper body strength and mobility. Simply line the ramp up with the pins, give it a slight push and you're in the game! Made of high strength aluminum alloy with clear anodized finish and easily assembles with push pins, no tools required. Assembled ramp is 58" long with four rubber feet to protect floor and add support. U-shaped rear frame is 25" x 25". Weighs 5 lbs.

X15180\$219.99 ea.



ZONE APE Bowling Bell Bands

Add a bell to your favorite equipment.

Scrunchy style band with bells inside uses Velcro to add bells to standard items such as bowling pins for auditory reinforcement. Set of 10. Pins sold separately.

17252\$24.99 set



Deluxe Bowling Cart

Conveniently stores and safely transports bowling equipment.

Features four large baskets and a ball shelf. Top corner bars serve as push/pull handles or hold accessories. Holds up to 12 regulation-size bowling balls or 60 pins. Heavy duty 3" swivel locking casters, no-mar rubber wheels. Baskets measure 27"L x 18"W x 12"H. Cart measures: 41"L x 24"W x 56"H. (Bowling equipment not included.)

X36232\$239.99 ea.

SCOOTERS

OUR MOST POPULAR
SCOOTER
IS AVAILABLE IN 2 SIZES!

12" OR 16"



ZONE Heavy Duty 12" Scooter Set

With handles for safety!

Built tough with molded polyurethane construction. Features non-marring rubber wheels with ball bearing casters. Use connectors on page 196 for attaching scooters to each other. Sold in a set of 6 only.

17076 SET OF 6 \$105.99 **SALE \$89.97 set**

ZONE Heavy Duty 16" Scooter Set

Smooth rolling rubber wheels!

Big 16" x 16" molded polyurethane platform is reinforced for strength. Wheels will not mar floors. Use connectors on page 190 for attaching scooters to each other. Sold in a set of 6 only.

X17092 SET OF 6 \$144.99 **SALE \$129.97 set**

EASY ROLLING

TONGUE AND GROOVE CONNECTION



Ultra Glide Connecting Scooter Boards

Improved platform-now connecting!

These scooter boards have the latest design in a ribbed reinforced platform with a patented connect-a-scooter feature that allows scooters to be connected to each other. The platform carries a 5 YEAR WARRANTY.

Available in two sizes in sets of 6.

X17072 SET OF 6 12" x 12" \$139.99 set

X17047 SET OF 6 16" x 16" 179.99 set

17116 Replacement Wheels - Set of 6 34.99 set

EXTRA RUGGED

TONGUE AND GROOVE CONNECTION



Rubber Wheel Connect-A-Scooters™

For indoor or outdoor use!

High impact plastic board with 2" rubber composite wheels.

Features a tongue and groove component that allows scooters to be connected together. Available in two sizes in sets of 6 or individually in yellow or blue.

X17120 SET OF 6 12" x 12" \$134.99 set

X17122 SET OF 6 16" x 16" 164.99 set

17121 12" Yellow 17125 12" Blue 24.99 ea.

X17123 16" Yellow X17126 16" Blue 34.99 ea.

17117 Replacement Wheels - Set of 6 35.99 set



No Handle Scooters

Just the basic scooter.

Made from high impact plastic with non-marring swivel casters. Available in 12" or 16" in sets of 6 or individually.

17032 12" Yellow \$15.99 ea.

X66471 12" Yellow -Set of 6 87.99 set

X17033 16" Blue 19.99 ea.

X66472 16" Blue -Set of 6 103.99 set

SCOOTERS



ZONE 12" Scooter Set with 3" Wheels

Ideal for indoors or outside!

Tough 12"x12" scooter with molded plastic construction. Features 3" all-terrain rubber wheels. Sold in a set of 6 only.

X17139 SET OF 6 \$159.99 SALE \$139.97 set

ZONE 16" Scooter Set with 3" Wheels

Smooth rolling 3" wheels!

Big 16" x 16" molded plastic platform is reinforced for strength. 3" all-terrain wheels will not mar floors. Sold in a set of 6 only.

X17140 SET OF 6 \$229.99 SALE \$199.97 set

SUPER TOUGH



TONGUE AND GROOVE CONNECTION



All Surface Scooters

Rugged enough for asphalt or concrete!

High impact plastic board with handles and 4" all surface heavy duty casters. Available in two sizes in sets of 6 or individually in blue only.

- X17038 SET OF 6 12" x 12" \$229.99 set
- X17065 SET OF 6 16" x 16" 259.99 set
- X17040 12" Blue 45.99 ea.
- X17042 16" Blue 55.99 ea.
- 17132 Replacement Wheels- Set of 4 37.99 set

INDOOR/OUTDOOR



TONGUE AND GROOVE CONNECTION



Inline Wheel Scooters

Pivots quick to change direction!

Sits up high on 4" inline skate style casters that makes this the smoothest rolling scooter on the market! High impact plastic. Available in two sizes in sets of 6 or individually in blue only.

- X17030 SET OF 6 12" x 12" \$234.99 set
- X17107 SET OF 6 16" x 16" 264.99 set
- X17035 12" Blue 48.99 ea.
- X17037 16" Blue 57.99 ea.
- 17133 Replacement Wheels- Set of 4 37.99 set



Contoured Scooter

Curved design for better control!

Quicker and flowing movements for arms and feet with handles for finger protection. Made from high impact plastic with non-marring casters. Measures 12" x 16". Blue only.

- 17001 \$15.99 ea.
- X66473 Set of 12 191.80 set



Two-Fer™ Double Scooters

Ideal partner scooter!

Great for relay races, scooter hockey and more! Measures 28" L x 14" W and is made from high impact plastic with 6 non-marring swivel casters and 4 hand protecting side handles. Sold in a pair, one yellow and one blue scooter.

- X17012 \$79.99 pr.

NEED GAME IDEAS? Visit www.PEwithpalos.com for FREE games and activities.



SCOOTER GAMES



NEW

Shield® Scooter Hockey Colored Sticks

Perfect for pairing with matching scooters.

Made from ABS plastic in six assorted colors. Measures 21.5" L.

17356.....\$42.99 set



Basic Scooterboard Hockey Set

The floor hockey set played on scooter boards.

Lightweight plastic sticks with a uniquely curved blade. The blade shape allows for a smoother safer play for younger kids. Recommended for grades 1-3 only. The sets contain 12 sticks (6 red and 6 yellow), one 6" foam ball and two pucks.

17002.....\$25.99 set



ZONE Soft Scooter Hockey Set

Soft foam with rounded edges!

Vinyl coated foam blades and handles allow safe and fun play. Set includes: 12-sticks: 6- blue, 6-yellow, 1-7" foam ball and 1-4" puck.

17093.....\$92.99 **SALE \$79.97 set**

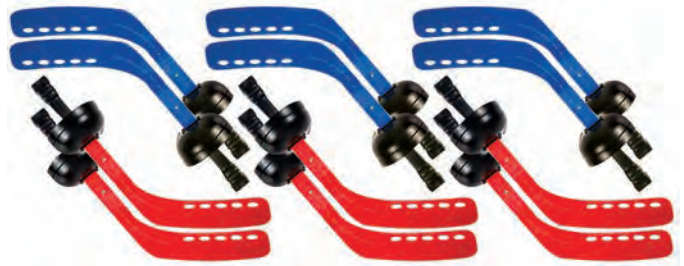

Shield® Scooter Hockey Set

Hand shields protects players from errant pucks, sticks and scooters!

Made from ABS plastic with plastic blades and shields. Pack includes 12 sticks (6 red & 6 blue) 1 Hot Ball and 2 Soft Shot Pucks.

17025 Red- Set of 6 sticks.....\$47.99 set

17028 Blue- Set of 6 sticks.....47.99 set

66517 12 Player Pack- 12 sticks, 2 pucks & 1 ball.....85.99 pk.



Scooter Board Hockey Set

Scooters + Hockey = Major Cardio Fun!

Plastic sticks with molded handle. Set includes 12 sticks- 6 red, 6 yellow, a vinyl hockey ball and puck.

17137.....\$36.99 set



Scooter Link

Connect scooters together to create new scooter activities.

Use to link any two scooters of the same height. Create a scooter train by connecting more than one. Made from durable polypropylene plastic. Use two links per scooter. 3"L x 2"W.

66541 Set of 6 (3 pairs).....\$8.99 set

66786 Set of 36 (18 pairs).....46.99 set

Scooter Games

New ideas that are easy to play!

Over 100 activities for developing social, physical and cognitive skills. and incorporating math, health, science, teamwork, problem solving and sportsmanship concepts. Includes 50 reproducibles to assist in assessment, explain games and stress safety.

38162 208 pages.....\$26.99 ea.



ZONE Scooter Pack

With game book full of activities!

Includes:

2 sets 17076 Heavy Duty 12" Scooter Set

2 sets 66541 Scooter Links

1 set 17137 Scooter Board Hockey Set

1 set 17044 Mushroom paddles- set of 12 (2/17043)

1 ea. 38162 Scooter Games Book

1 ea. 17011 Snap Stacker Pole & Strap Kit

X66723 ..\$434.99 pk. **SALE \$319.97 pk**



SCOOTER GAMES



Colored Mushroom Paddles

Available in 6 colors!

Coordinate paddles with your scooters to create teams, taggers and more. Paddles have a neoprene foam handle with 5" diameter colored mushroom bottom. Won't mar or scratch wood floors. Sold in sets of 6 or 12.

- 17043 SET OF 6 \$36.99 set
- 17044 SET OF 12 - 2 of each color 69.99 set



ZONE 2-N-1 Lacrosse Stick Set

Flexible heads detach to use for scooter hockey!

Get more bang for your buck! This multi-purpose set includes 12 sticks with aluminum shafts, detaching soft plastic heads, and 6 balls.

- X15272 Complete Set- 12 sticks & 6 balls \$189.99 SALE \$159.97 set

SCOOTER STORAGE



Snap Stacker Pole and Strap Kit

Convert your existing scooter into transport scooters.

The spring loaded locking mechanism snaps in place without damaging your scooter! Made from galvanized steel, this 1/2" x 30" tall pole will hold up to 15 scooters. The pull strap loops through the bottom scooter handle for easy moving. Pole fits most scooters. Scooters not included.

- 17011.....\$23.99 SALE \$18.97 ea.



Scooter Stacker

Makes transporting scooters a breeze!

This simple conversion of a 16" scooterboard will make storing and transporting up to sixteen 12" or 16" scooter boards a breeze. Features include a low center of gravity that makes it very stable, ultra glide casters roll smoothly on carpeting as well as gym floors and it has a heavy duty tow strap for easy transportation.

Scooters sold separately.

- 21086.....\$41.99 set



Scooter/Cone Cart

Stores and transports your scooters or cones

Stacks up to 30 scooters, eighty 12" cones or fifty 18" cones. Stores and transports your scooters or cones. Constructed from 1" galvanized steel with 8" rubber wheels with a tip and roll transport action. Measures 47"H x 30"W x 18"D. Scooters not included.

- X36149\$139.99 ea.



Scooter Storage Cart

Holds up to 48 scooters!

Compact, upright storage. Made from heavy duty, impact resistant PVC with 3" non-marring swivel casters. Measures 26.5"L x 21"W x 54.25"H. Some assembly required. Scooters not included.

- X17015\$185.99 set



Easy Roll Scooter & Cone Cart

Four wheel design- no tilting needed!

With 8" hard rubber rear tires and 2 front swivel casters, this cart glides along- indoors or outside. Made from 1" galvanized steel with a compact, space saving design. Holds up to 24 12" scooters or 50 18" cones. Made in the USA. Measures 47"H x 30"W x 18"D. Scooters/Cones not included.

- X36056\$224.99 set

RIDE-ONS



Twist-N-Scoot

Push your feet back and forth to make this scooter go!
 Durable metal frame with powder coat finish, strong swivel caster front wheels, rubber rear wheels. Low seat design for a variety of users. Measures 27.5"L x 20"W. Weighs 14 lbs.
X16174 \$105.99 **SALE \$93.97 ea.**



PlasmaCar®

Just steer and away you go!
 No gears, batteries or pedals, just use a fluid side to side motion to generate the movement. Unique, impact resistant plastic design capable of holding up to 220 lbs. Use on smooth surfaces, indoor or outside. Measures 32"L x 11.2"W x 10.5"H. Some assembly required.
X16123 \$69.99 ea.

Multi-Sport Helmet

One of the coolest helmets on the market!
 It's cool looking, so kids will be apt to wear it! Comes with a shock absorbing EPS liner, an ABS impact dispersing outer shell, quick release Nexus buckle and sponge foam adjustment set. Meets the CPSC standards. Available in 3 sizes.
13100 Small 21.25"-22.5" \$15.99 **SALE \$13.97 ea.**
13101 Medium 22.5"-23.25" 15.99 **SALE 13.97 ea.**
13102 Large 23.5"-24.5" 15.99 **SALE 13.97 ea.**



Sport Roller Racer®

The only power source needed is kids!
 Simply swing the handlebars side-to-side to propel. Provides excellent physical benefits. Heavy duty frame and seat. Rams-horn handlebars keep hands safe. Ages 3-10. Fully assembled.
17009 200 lb. weight capacity. \$119.99 ea.



Deluxe Roller Racer®

Enhanced model of the Sport Roller Racer!
 All of the benefits and quality of the Sport model plus: an extra metal plate welded to the underside of the handlebar for maximum strength, ABEC-1 wheel bearings for a super-fast/ smooth ride, Rated for institutional use. Ages 3-12. Fully assembled.
17138 250 lb. weight capacity. \$129.99 ea.



Floor Surfer®

Roller board for play and therapy.
 The Floor Surfer® appeals to children and combines play and the training of motor skills. Developed in partnership with children's physiotherapists to ensure safe use by any child regardless of motor skill level. The Floor Surfer® unites function, safety and design. Maximum weight 220 pounds.
X16545 220 lb. weight capacity. \$115.99 ea.

Roller Racer Sit-Skate 8 Packs

Your choice of sport or deluxe models!
 Includes 8 roller racers and specially designed caddy. Caddy stores 8 Roller Racers and is constructed of high impact PVC with a low center of gravity to prevent tipping. Set of 6 locking non-marring swivel casters makes caddy portable. Measures 35"L x 19"W x 38"H.
X17159 Sport Racers with Caddy. \$889.99 pk.
X17160 Deluxe Racers with Caddy 949.99 pk.
X17010 Roller Racer Caddy only 194.99 ea.



BALANCE BOARDS



14" Wobble Board

Basic balance training!

Heavy duty resin construction with slip resistant grip circles for safety. 14" diameter, fixed height for basic strength and balance exercises.

13091 \$16.99 ea.



15" Tri Level Balance Board

Adjusts to 3 heights!

15" diameter board made from molded ABS construction with textured top for grip. Increase challenges by adjusting up to 4" maximum.

13071 \$29.99 ea.



Balance Board

How long can you balance?

Constructed of wood, this board is used in teaching balance while strengthening the ankle and lower leg muscles. The 31.5" x 10.25" hardwood roller moves freely within the track on bottom of board.

X13024 \$84.99 ea.



Balance Master

A simple and fun work out for muscle control and coordination.

Constructed of hard poly plastic with a non-slip sanded foot surface. Platform is 29"L x 9"H. Shipped in assorted colors.

X13026 \$79.99 ea.



Ultimate Balance Board

Includes 2 snap-on height adjusters!

It's three boards in one with additional snap on fulcrums for three height levels! Made from molded resins for long lasting wear. Oversized foot shaped platforms with non-skid stippling keeps feet in place while balancing. Measures 19.5"L x 11"W. Maximum weight 175 lbs.

13012 \$33.99 ea.



The Spooner™

A great lead up and trainer for board sports!

Improve balance and practice skate, surf and snow boarding moves anywhere! Made from unbreakable, textured, high density polyethylene with raised edges. Both boards measures 11.5" wide. The Freestyle is 22.5" long and is ideal for users under 4' tall or all ages who want a shorter board. The Pro measures 25.5" long and is preferred by users over 4' tall.

15935 22.5" Freestyle- assorted colors \$44.99 ea.

15966 25.5" Pro- assorted colors 53.99 ea.

15967 SET OF 6 22.5" Freestyle 249.99 set

15968 SET OF 6 25.5" Pro 299.99 set

VIDEO ONLINE



Wiggle Board

Improve balance and core strength!

Players rock from side to side, spin 360 degrees or walk like a duck. Molded in one piece from reinforced polypropylene.

Measures 22.5"L x 4.5"W x 3.5"H. 200 lb. maximum weight capacity.

13082 SET OF 6 \$69.99 SALE \$59.97 set

13083 Assorted colors 11.99 ea.



Indo Board Balance Trainer

Safely teach balance progressions for all ages!

Curriculum Guide adheres to National Standards and combines the fun of surfing, skateboarding, and snowboarding with the physical benefits of core conditioning. Balance deck measures 30"L x 18"W with a non slip top, includes 6.5" roller and 14" diameter polyvinyl balance cushion for beginners. Curriculum features lesson plans for grades K-12 with an instructional DVD. Trainers DVD demonstrates Indo Board core and balance exercises.

13079 Natural Indo Board w/Roller and Balance Disc \$189.95 set

13156 Natural Indo Board w/Roller 159.95 set

38176 Indo Board P.E. Curriculum Book & DVD 79.95 ea.

39168 Indo Board Trainers DVD Volume One 14.95 ea.

VIDEO ONLINE



BALANCE/MOVEMENT



Balance Pods

Improve balance, body awareness and coordination.

Arrange with flat side down or up for varied levels of difficulty. Pods are made from heavy duty vinyl, air injected and measure 6.25" x 3.5". Sold in a set of 6 assorted color pods. Includes instruction sheet.

13051 SET OF 6 \$42.99 set



TruDisc™ Rubber Balance Discs

Soft and safe for stepping fun.

These 5.5" diameter discs are made from a firm rubber with a thick vinyl coating. Use for balance activities, tossing, catching, rolling or as giant hockey pucks. Sold in a set of 6.

13005 SET OF 6 \$34.99 SALE \$29.97 set



Stability Fit Pads

Ideal for balance training, coordination and posture improvement. Increase difficulty for progressive training by inflating or deflating. One side features spiky bumps while the other side has a round bump. Measures 13.5" in diameter. Available in a set of 6 neon colors.

13151 SET OF 6 \$99.99 set



GoFit CoreStability Disk

Helps develop stability and core strength.

Features a reflexology (textured) side and smooth side. Vary difficulty by increasing or decreasing inflation. Includes disk, manual and inflation needle. 13" D.

17415 \$23.99 ea.



Foam Big Foot Walkers

Teaches hand-foot coordination.

Durable closed cell ethafoam material with braided nylon cords. Kids will have fun walking on these and using their imaginations as they further develop their motor skills. Set of 6 or individually in assorted colors.

13163 SET OF 6 \$96.99 set

13164 Assorted Colors 19.99 pr.



Playzone-fit Balance Blox™ Slackline Kit

Body Control... Motor Skills... Concentration!

Kids will gain self-confidence and excitement after mastering the balance blox slackline. Sit or stand to develop balance and agility. Multiple designs and layouts can be created with additional slacklines. Includes: 2 Slackline Blox™ and one set of 5' (1.5m) slackline & pole, hardware, tools, and instructions. Ages 3+. Weight limit 125 lbs.

45097 \$71.99 ea.



Playzone-fit Balance Blox™ Quad Kit

Up to 4 kids can play or balance as a team. Create multiple layouts and patterns which helps kids develop body control, motor skills, and concentration. Includes 4 Slackline Blox™ and 4 sets of 5' (1.5m) slackline & poles, hardware, tool & instructions. Ages 3+. Weight limit 125 lbs.

45098 \$179.99 ea.



FOLDS FOR EASY STORAGE

Poly Balance Beam

Ideal for the beginning gymnast... builds self-confidence, balance and foot placement.

This heavy poly vinyl beam stands 1" off the ground and is 8' long by 4" wide. Folds in half for easy storage and carrying.

45005 \$91.99 ea.

BALANCE BEAMS



ZONE Build-A-Beam

Use the segments to create your own beams!

Made from sturdy plastic with a slightly textured top, these segments slide together to create beams of any length or shape. Segments measure 12.5"L x 4.6"W x 2.36"H. Your choice of straight or curved segments.

- 45093 Set of 10 Curved \$39.99 **SALE \$29.97 set**
- 45094 Set of 10 Straight 39.99 **SALE 29.97 set**
- 45095 Set of 20-10 Curved & 10 Straight 59.84 **SALE 57.97 set**
- 45096 Set of 40- 20 Curved & 20 Straight 119.88 **SALE 109.97 set**



Create-A-Beam

Endless balancing challenges!

Use your creativity to create dozens of balancing challenges with easy to connect, extremely durable foam sections. Each section is 15"L x 5.25"W x 2.5"H and is easily joined together by inserting 6" plastic rods into pre-set holes. Beam designs can be created and disassembled in less than a minute and quickly and compactly stored. The 18 piece set includes 3 sections of each color: red, orange, yellow, green, blue and purple. Activity guide included.



- X45055 \$124.99 **SALE \$114.97 set**



Curved Balance Beam

Colorful addition to obstacle courses!

Arrange these curved 12"L x 6"W colorful plastic blocks (overall length 144") into patterns by simply sliding them together. Create two personalized beams or one circular balance beam to aid motor skill development. Beam comes in 2 sets of blocks in 6 colors: red, orange, yellow, blue, green and purple. Yellow Center Connector allows you to connect pieces together creating endless configurations.

- X45053 12 Curved Beam Pieces only \$79.99 set
- 45059 Yellow Center Connector only 6.99 ea.
- X66464 24 Curved Beam Pieces & 1 Yellow Connector 165.99 set

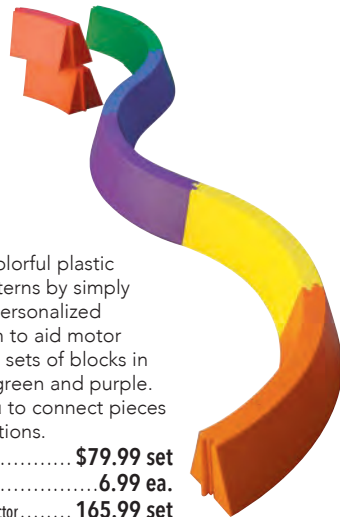

Curve-A-Beam™

One set can configure 15 balance challenges!

Each section is 2' long and 4.5" wide and made from institutional tough, tear resistant Ethafoam with a slight curve to it. Ends can be laid together to create paths and challenges. Set includes 6 sections and pictorial guide.

- X45036 \$71.99 ea.



Super Balance Pack

With our most popular items!

Walk along curved paths, scale the mighty river stones and traverse over the field of dome cones. Use your imagination to create unique scenarios and stations in your class!

Pack includes:

- 1 set X45053 Curved Balance Beam- 12 Piece Set
- 1 set 45036 Curve-A-Beam™
- 1 set 13050 Dome Cones- Set of 36
- 1 set 13051 Balance Pods- Set of 6

- X66589 \$239.99 pk.



StarterBeams™

Lightweight and durable!

Each beam section measures 2'L x 5"W x 2.5"H and connects with impact resistant plastic plugs. BeamDocks measure approx. 10"W x 2.5"H and connect to beams to create challenging and fun patterns. StarterBeams and BeamDocks are made from no tear unbreakable Dura-Tuff™ foam. Set includes 6 StarterBeams, 6 BeamDocks and an activity guide with over 30 set ups and creative patterns.

- X45040 \$124.99 **SALE \$114.97 set**

BALANCE & MOVEMENT



Premium Hop Balls

Heavy-duty bouncers for indoor or outdoor play. Use for relay races, team play or just for fun. Match your students age to the proper ball size. Ages 3+ Hop 45, ages 6+ Hop 55, and for ages 9+ Hop 66. **△ CHOKING HAZARD (1) – SMALL PARTS. Not for under 3 yrs.***

15003 Hop 45- 18" size - Max weight 100 lbs.....	\$19.99 ea.
15004 Hop 55- 22" size - Max weight 125 lbs.....	22.99 ea.
15005 Hop 66- 26" size - Max weight 150 lbs.....	26.99 ea.
17183 Hop 45 6 Pack.....	109.99 pk.
17184 Hop 55 6 Pack.....	129.99 pk.
17185 Hop 66 6 Pack.....	154.99 pk.



ZONE Lightweight Hop Balls

Bouncing fun with your favorite sport! Features durable vinyl with a textured bottom, recessed inflatable valve and the easy grip handle. **△ CHOKING HAZARD (1) – SMALL PARTS. Not for under 3 yrs.***

13126 22"	\$15.99 ea.
13127 24"	17.99 ea.
17186 22" Hop Ball 3 Pack	45.99 pk.
17187 24" Hop Ball 3 Pack	49.99 pk.



ZONE Loloball

A fun way to develop coordination, rhythm, balance and timing! Loloball is a rubber ball encircled by a durable 15" plastic ring. Individuals stand on the ring, gripping the upper ball portion between their feet, and begin bouncing. Supports up to 185 lbs.

13001	\$14.99 ea.
17283 Loloball 6 Pack	\$89.90 SALE \$79.97 pk.

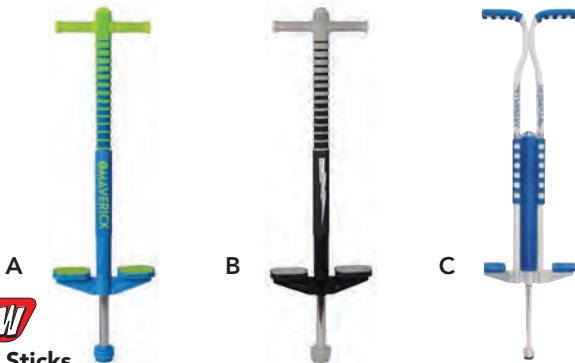

NEW

Pogo Sticks

An addictive coordination enhancer. These precision sticks are made from a high strength metal, covered in durable colorful foam that will not rip. They are built to last for years. Features non-slip safety handles, foot pads and rubber tip. Choose from 2 models.

X17400 Maverick 2.0 Blue/Green - Ages 5 to 9; supports 40 - 80 lbs.....	\$55.99 ea.
X17401 Maverick 2.0 Black Lightning - Ages 5 to 9; supports 40 - 80 lbs.....	55.99 ea.
X15826 Master White/Blue - Ages 8 & up; supports 80 - 160 lbs.....	59.99 ea.

* Full **CHOKING HAZARD** descriptions on page 355.



NEW

Monkey Business Bungee Jumper

Brings the springy fun of "pogoing" to younger children. Perfect for kids who have not yet developed the motor skills and balance to use a traditional pogo stick. Features a squishy foam base with a tethered handle. Measures 21 inches tall from the base to the handle. Ages 6+. Weight limit 250 lbs.

13090	\$22.99 ea.
-------------	-------------



POTATO SACKS



Poly Potato Sack
Durable and easy to clean!
Made from a heavy duty polyethylene that allows you to wipe away mud and water. Measures 40"L x 23"W.
16807 .. \$39.99 **SALE \$33.97 dz.**

DOUBLE THE FUN!



Double Potato Sack
Stitched together for partner fun!
Talk about team work and coordination! Classic, genuine, burlap potato sack with double stitched seams provide each user a 24" wide compartment. Measures 48"W x 40"H.
16020..... \$9.99 ea.



Potato Sacks
Helps motor skills and coordination!
Large heavy duty burlap bag, ideal for repeat use. Each bag measures 36"L x 22"W. Pack includes 12 Potato sacks.
13002 \$2.99 ea.
13155 Pack .. \$35.80 **SALE 30.97 pk.**



Potato Sack Set
Numbered six color set!
Numbered 1 through 6 in various visual patterns: dots, numbers, English, Spanish, and French. Constructed of super strong double-stitched nylon. 24" wide by 27" high.
13045 SET OF 6..... \$54.99 set

STILTS

Sky Walkers Stilts

Extremely durable, easy adjustments and easy to use.
This high quality stilt will support up to 250 lbs. It adjusts to 4 different heights from 4" to 18". Wide PVC footpads, non-marring tips (not recommended for use outside), 1.25" diameter.
13014..... \$94.99 pr.

UNIQUE PIN SYSTEM
ALLOWS YOU TO
ADJUST STILTS
TO 4 DIFFERENT
HEIGHTS!



Walkaroo™ Stilts

Now easier to learn, easier to use and more fun!
The ergonomically correct design has an S bend which wraps comfortably around the shoulders for improved posture. Another bend at the foot platform (11" above the ground) places your weight directly over the lower pole for vastly improved control. Made of rugged tubular steel, with a non-marking rubber foot. Quickly adjusts to accommodate anyone from 4' 6" to 6' 6", maximum weight capacity is 250 lbs. Ages 8 & up.
X13078..... \$56.99 pr.



Platform Stilts

A great lead up to stilt walking!
A great balance challenge with adjustable hand cords and non-marring rubber base rims. Made from heavy duty plastic and will support up to 175 lbs. Available in 6 pairs or individually in assorted colors.
13048 SET OF 6 Platform Stilts..... \$46.99 **SALE \$34.97 set**
13049 Assorted Colors..... 9.99 pr.



Multi-Stilts™

A combination of the traditional rope and bucket stilts!
Convert these stilts into two different balance challenges with a click of a pole! Simply twist and lock the pole into the bucket for balancing fun or remove the pole and insert the vinyl ropes into the sides for more challenging activities. Made of 29" PVC poles and 60" nylon ropes. Each bucket comes with both pole and rope attachments.
13004 SET OF 6 (12 Buckets, 12 Ropes, 12 Poles)..... \$149.99 set

BALANCE



Wooden Egg & Spoon Set

Both egg and spoon have a flat side for younger users! Use the flat side for easy transport, flip over spoon and lay the egg done for a much more challenging game! Includes 6 painted 12" wooden spoons and 6 painted 2" tall wooden eggs.

16799 SET OF 6.....\$13.99 set



ZONE Catch-A Ball

Flip the ball in the air and try to catch it in the cup! Sounds simple enough and it's even easier with this oversized plastic cup. All plastic, it includes a baseball size whiffle ball attached to a sturdy nylon cord that loops around the handle. Remove the ball and cord and play bounce catch with tennis balls, play relay races with yarn balls, balance larger balls on them, the ideas are all in the cup. Sold in set of 6.

15554 SET OF 6.....\$19.99 SALE \$14.97 set



Peacock Feathers

Excellent first step in teaching "looking up" skills required in juggling. Start with the peacock feather on the palm of your hand. Look at the top. Now move the feather to your finger tip, the back of your hand, your wrist, your elbow, your shoulder, even your nose. Walk slowly around the room with the peacock feather on your hand, balance on one foot and balance the peacock feather on the other. Approximately 36" long, 12 feathers per set.

15080 Set of 12.....\$16.99 set



Foam Water Noodle

Affordable fun floating foam water log. This 58" long by 2.75" diameter floating device is an excellent substitute for kick boards or just a fun floating water apparatus.

X58021 Box of 20.....\$75.99 box



ZONE Ice Cream Scoop Relay

We all scream for ice cream! Each team has one of six colored foam ice cream scoops. The goal is to be the first team to collect all six colors of ice cream scoops. Includes 6 ice cream cones and 36 ice cream scoops.

17204.....\$89.99 set



ZONE Giant Egg and Spoon Set

A large version of the classic egg-and-spoon race! Develops hand-eye coordination and balancing skills. Eggs and spoons can easily be used in other activities. Both eggs and spoons are covered in a soft fabric. Includes 6 eggs measuring 12" x 20" and 6 spoons measuring 8" x 15". Sold in a set of 6.

17161 SET OF 6.....\$99.99 set



Crawling Tunnel

Helps stimulate physical development, strengthen core muscles, and gross motor skills. Versatile tunnel stretches and rolls on the ground as child crawls through it. Place on its side and use as a target or ball pit. Easily disassembles into three pieces for easy storage.

X15513 35" Crawling Tunnel.....\$99.99 ea.

X17359 41" Crawling Tunnel.....119.99 ea.

JUGGLING



ZONE Pellet Balls

A limited-roll tactile ball perfect for toss games.

These balls contains tiny pellets and have a tacky vinyl cover. They are squishy, yet dense. Pellet balls are great for bocce, juggling, Adapted PE programs and more. Latex free. Measures 2.5" diameter.

18252 SET OF 6 \$26.99 SALE \$19.97 set



Juggling Scarves

The first step in learning to juggle.

The slow moving 14" square scarf makes it so easy that anyone can learn how to juggle. Helps build confidence and teaches the correct toss pattern. Comes in assorted bright colors in the school pack of 108 or add to your present programs with our fill-in pack, set of 12.

15219 Set of 12 \$13.99 SALE \$9.97 set
15077 School Pack (bag of 108) \$135.00 SALE 88.97 bag

Juggling Bean Bag Squares

Step two in learning how to juggle.

Colorful 2" solid color canvas juggling cubes. These beanbag squares are easy to toss and catch.

15079 Box of 36 \$107.50 SALE \$79.97 box
15071 Set of 3 8.99 set



Juggling Bean Ball Sets

Easy to handle 1.75" no bounce balls!

Premium vinyl and tightly packed with plastic pellets. Class Packs includes 12 sets for a total of 36 balls.

15212 Set of 3 \$4.89 set
66125 Class Pack-12 sets of 3 balls 49.99 set

Rubber Juggling Balls

Specially designed "snow tire" tread grip!

Tactile grip gives every juggler more confidence and a feel for the activity. Measures 2.25" diameter and weighs 3.5 oz. each.

15288 \$15.99 dz.



ZONE 3-Color Foam Ring Set

Vibrant flying rings make toss and catch games fun!

Players toss rings and try to get their chosen color closest to a stake, or teams earn points by catching the rings on the color assigned. Made of soft durable foam. Includes 3 - 13.75" rings.

17229 Set of 3 \$21.99 SALE \$16.97 set



Spinning Plate

Develops hand-eye coordination, body stability, quickness and balance.

Can you balance the plate on a stick? Great- now slowly twirl it around and watch it spin! A fun addition to circus and juggling activities! Don't worry- it's a 9.25" round plastic plate with a lip and 19.75" stick to keep it safe from falls.

15723 Set of 4, assorted colors \$24.99 SALE \$19.97 set
66128 Pack of 12 Plates & 12 Sticks 74.90 SALE 52.97 pk.



Diabolo

The Chinese Diabolo is an ancient form of recreation.

By holding the two 24" wooden dowel sticks in each hand you "yo-yo" the diabolo on the string. After mastering the basic "yo-yo" you can test your skill by tossing it up in the air and catching it. The plastic diabolo is about 4.5" in diameter. A set consists of one diabolo and one set of hand sticks.

15083 Diabolo \$13.99 SALE \$9.97 ea.
66127 Class Pack of 12 sets 167.80 SALE 109.97 pk.



Juggling Ring Set

Lightweight and easy to catch!

Made from high impact plastic and rounded edges for comfort. Big 12.75" diameter makes these rings easier for beginners. Class pack includes 12 rings (4 sets of 3).

15934 Set of 3 \$8.99 set
66321 Class Pack 28.99 pk.



GOLF CLUBS

Golf Clubs

Combination of perimeter and peripheral weighting for optimal play. With a cavity back the larger sweet spot is ideal for beginners. Steel shaft and pro style grips create an excellent, long lasting club. The split wood soleplate design creates a perimeter weighting on all the woods for a superior feel and balance. Standard adult size for ages 13 and up. Specify left or right handed and club. Sets do not include bag.

WOOD									
Description	1	3	4	5	6	7	8	9	PW
Left Hand	270301	270311		270331					
Right Hand	27030	27031		27034					
Price Ea.	\$29.99	\$29.99		\$29.99					

IRON									
Description	1	3	4	5	6	7	8	9	
Left Hand		270401	270411	270421	270431	270441	270451	270461	270471
Right Hand		27040	27041	27042	27043	27044	27045	27046	27047
Price Ea.		\$20.99	\$20.99	\$20.99	\$20.99	\$20.99	\$20.99	\$20.99	\$20.99

Description	Sku	Price
RH: 7 Club Set: 1 & 3 Wood, 3,5,7 & 9 Iron with Putter	27010	\$133.99 set
LF: 7 Club Set: 1 & 3 Wood, 3,5,7 & 9 Iron with Putter	270101	133.99 set
RH: 11 Club Set: 1,3 & 5 Wood, 3-9 Irons & Putter	27074	192.99 set
LF: 11 Club Set: 1,3 & 5 Wood, 3-9 Irons & Putter	270741	192.99 set
Wood/Iron Pack- 5-#3 Woods, 5-#5 Irons & 5-PWs	66324	369.99 pk.
Assorted Iron Pack: 5-#5 Irons, 5-#7 Irons & 5-PWs	66325	329.99 pk.
Seven Iron Pack- 15-#7 Irons	66326	329.99pk.



Putters

Two way putters.

Official grip, steel shaft and anodized metal head.

- 27050 Adult 34" \$19.99 ea.
- 27051 Junior 27" 19.99 ea.



ZONE Golf Clubs

Lightweight, sized just for kids!

These 27" right hand only clubs have a foamed grip, plastic shaft and solid plastic club head. For use with foam or whiffle balls.

- 27154 SET OF 6 7 Iron \$24.99 set
- 27155 SET OF 6 Putter 24.99 set



Mini Golf Set

Top quality beginner set for young players!

24" clubs are made from sturdy ABS plastic. The 5" putting rings are made from strong polyethylene and the 1.7" putting balls are made from soft, flexible EVA foam.

- 27078 6 putters, 18 rings, 18 balls \$67.99 SALE \$59.97 set



Safe-T Putters

Softer head reduces damage to hitting surfaces!

Made with a soft touch urethane mold around the entire blade and has a bull's eye and aiming line on the head to improve putting. Set of 6 putters includes 6 colored golf balls or purchase putters individually by color below.

- 66347 27" Putters & Colored Golf Balls Set of 6 \$140.99 SALE \$129.97 set
- 66348 33" Putters & Colored Golf Balls Set of 6 140.99 SALE 129.97 set

Description	Red	Orange	Yellow	Green	Blue	Purple	Each
27"	27123	27124	27125	27126	27127	27128	21.99
33"	27112	27117	27111	27113	27114	27118	21.99



12 Player Putting Pack

Create challenging putting stations!

Packs include:

12 Safe-T Putters, 12 Colored Putting Balls, 12 Putt-O-Cups™ and a 36" L x 16" W x 16" H all purpose, heavy duty polyester equipment bag.

- 66117 Pack w/ 29" Putters \$349.99 pk.
- 66118 Pack w/ 33" Putters 349.99 pk.

GOLF PACKS



NEW

Golf Pool

An exciting game that combines the challenge of golf with the game of pool.

A great way to help kids build hand-eye coordination, strategic thinking, and basic putting skills. Kit includes green fabric mat – 78" L x 57" W, 2 carbon fiber golf clubs, 16 golf balls, and rails.

27213..... \$79.99 ea.



NEW

Golf Bocce

Practice your chipping skills while competing in a fun bocce themed game.

Played with rules similar to bocce ball, players take turns chipping their larger fleece balls towards the smaller Short Flyte ball (or jack). Play continues until one team reaches a score of 11.

Includes: 6 ZONE 7 Irons, set of 12, 3" premium fleece balls, set of 4, Short Flyte practice golf balls.

66793..... \$54.99 set



Par Putt Golf™

Durable and easy to set up!

Use on flat surfaces indoors or out. Complete curriculum with lesson plans are also included to integrate math skills, creative thinking, sportsmanship, cooperation and those with special needs. The golf systems measure 10' L x 40" W and are covered with a durable indoor/outdoor turf. Balls and putters not included. Ships by Truck. Contact customer care to customize your set.

T27080 3 hole set..... \$725.99 set
T27082 9 hole set..... 1,799.99 set

NEW

4Fun™ Cosmic Mini Golf

Creative layouts and obstacles make each hole fun and challenging.

The bright, removable, holes and accessories, plus the portable putting mat means this versatile course can be set up in countless designs on any floor. Includes: 5 obstacles, 5 tee mats, 5 holes with flags, 1 putter, 2 LED golf balls, wrinkle resistant putting mat and course border. Tee stakes for outdoor play and storage bag. 72" x 90".

27214..... \$99.99 ea.



AVAILABLE WITH PLASTIC -OR- OFFICIAL IRONS

10 Hole Golf Station

Create a variety of golf stations:

Use the numbered spots as the tee, and the cones, cone sleeves and flat hoops to create targets. Includes balls, carry bag and your choice of 27" plastic right hand 7 irons or official right hand 9 irons.

27198 10 Station Pack w/27" Plastic 7 Irons..... \$159.99 pk.
27199 10 Station Pack w/Official 9 Irons..... 349.99 pk.

6 Color Target Set

Create scoring stations, distance tossing or use colors for points!

Fully adjustable for increased challenge, set up for chipping drills. Made with a powder coated steel

frame with an 18" diameter netting. White frames with colored nets. Set includes 6 targets, one of each color or individually in assorted colors.

27137 SET OF 6..... \$114.99 SALE \$105.97 set
27001 Assorted Colors..... 23.99 SALE 19.97 ea.



Putt-O-Cups™

Excellent for group games!

These putter cups are constructed of a durable yet flexible vinyl-rubber mix. Cup diameter is 6.75", includes: 9 cups & flags, carrying case and scorekeeper.

27032..... \$33.99 set





LaunchPad™ Practice Mat

Practice shots from different lies!

Shoot off the tee, on the fairway or out of the rough! Synthetic turf with heavy rubber base. Includes different sized tees. Measures 1' x 2'.

27029 \$35.99 ea.



BirdieBall®

Ideal for school settings!

Polymer ring can take a chip, pitch or a full swing and show the spin, a fade or a draw just like a real golf ball. Maximum flight distance of 40 yards. 24" x 12" StrikePads allow practicing on any surface.

27028 BirdieBall® Set of 10 \$18.99 set

27027 BirdieBall® Box of 100 164.99 bx.

27014 StrikePad 12" x 24" 29.99 ea.



Foam Golf Balls

Premium vinyl limited flight coated foam balls. Larger 2.5" ball provides bigger target for beginners.

27049 SET OF 6 2.5" \$9.99 SALE \$6.97 set

27203 Set of 12 1.67" Yellow Balls 7.99 dz.

27152 2.5" Bag of 36 Balls ... \$63.90 SALE 39.97 bg

27204 1.67" Bag of 36 Yellow Balls 21.99 bg

PRACTICE MATS & BALLS



Practice Mat

Synthetic 1/4" thick mat for right or left hand players! Accommodates 2 rubber tees (included). 4 ground anchors are included for outdoor use.

27097 Measures 1' x 2' \$24.99 ea.

27156 Rubber tees 1.39 ea.



Heavy Duty Driving Mat

Best choice for institutional use!

Measures 25" x 13" with a 1" heavy rubber base and synthetic turf top. Includes rubber tee.

27002 \$32.99 SALE \$29.97 ea.

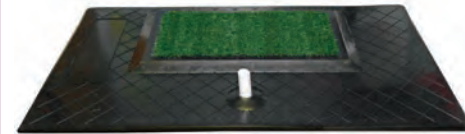

Training Golf Tee

The mat for driving and irons practice!

Thick, heavy rubber base measures 14"W x 26"L with rubber tee and a slightly raised synthetic turf section for hitting with irons. Indoor or outdoor use. Excellent for classes!

27023 \$47.99 ea.

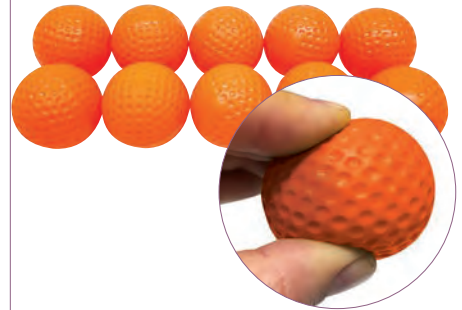

ZONE Vinyl Golf Balls

Perfect practice ball while transitioning from vinyl to regulation!

Durable vinyl is heavier than foam yet lighter than a regular golf ball. Realistic feel and look, great for indoors or out. Orange, set of 10.

27211 Set of 10 \$9.99 set



Neon Foam Golf Balls

18 soft dimpled practice balls.

Premium vinyl coated foam for limited flight. Includes mesh carry bag.

27205 \$14.99 set

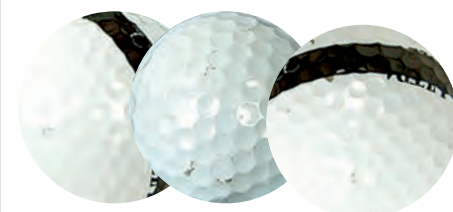

Practice Range Balls

Help save the environment!

Quality grade of mixed reworked and repainted balls with slight club marks, but no cuts.

27060 Balls only \$8.49 dz.

27061 Bag of 36 Balls 27.99 bg.



Short Flyte

Travels up to 30 yards and is washable.

Revolutionary Short Flyte practice golf ball has an open foam outside, and a hard core inside.

27079 Set of 4 \$4.99 set

27146 Bag of 36 Balls 42.99 bg.



Colored Putting Balls

Miniature golf-type balls!

Made with a Surlyn covering and two piece construction easy to wash and keep clean.

27109 SET OF 6 \$8.99 set

27151 Bag of 36 Balls 53.99 bg.



Plastic Golf Balls

Whiffle style, white with holes, limited flight.

Still one of the most popular teaching balls available.

27119 \$3.99 dz.

27148 Bag of 36 Balls 11.99 bg.

ACCESSORIES



Multi-Sport Net

Use for golf practice, soccer, football, baseball and more!

Tough small mesh with heavy duty nylon construction. Twist and fold design. Measures 7'H x 11'W x 5.6'D. Includes carry bag.

X27022 \$99.99 **SALE \$89.97 ea.**



Collapsible Chipping Net

Folds easily for storage or transport!

Fine-tune your short game with this target style chipping basket featuring three different-sized openings. Converts from a 23" to a 7" diameter frame. Perfect for either right- or left-handed golfers. Measures: 27.5"H x 16.75"W x 3"D.

27212 \$34.99 ea.



SKLZ Quickster™ ChippingNet

Can be used with regular or practice balls.

Features three different sized target holes and a ball-catching slot at the bottom for missed shots. Lightweight and portable with 30 second set up and patented Tension-Tite™ technology.

27129 \$35.99 ea.

Pro Putting Disc

Inner-outer plastic putting disc.

Improve your short game with this Pro Putting Disc! Made of plastic to provide durability Ball can enter from any side and exits from two openings.

27055 Single \$2.99 ea.

27193 6 Pack 15.99 pk.

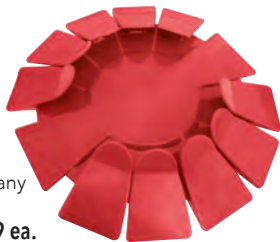

Putting Mat

9' putting green with electric ball return!

Regulation sized cup and non-directional turf provides the most accurate practice surface. Sets up easily and conveniently anywhere.

27086 \$39.99 ea.



Tru-Trak Putting System

Up your game!

Practice putts from multiple distances to improve accuracy. Regulation size putting cup and gravity fed ball return. Measures 108"L x 22"W x 4"H.

27210 \$49.99 ea.



ZONE PX-4 Bounce Free Balls

An oversized, limited flight ball perfect for beginners.

This 3.5" ball has more surface area which makes it excellent for K-4 students just learning the game of golf. The bright colors make them easier to track. Pairs well with The ZONE plastic 7 irons. May be used with metal clubs for more advanced users and longer distance.

10582 SET OF 6 \$18.99 set

TABLES



Joola® Inside

Includes slide on net!

- 5/8" MDF painted top
- Warp resistant frame
- Anti-tilting feature for safety
- 2" ball bearing smooth glide wheels
- Powder coated 2 piece undercarriage
- Call for freight quote- our regular shipping policy does not apply to this item.

C59072\$379.95 ea.



- .625" TOP
- 2" WHEELS

- Tournament grade net and posts
- Folds for playback and storage
- Measures 9'L x 5'W x 30"H
- Weighs 137 lbs.



Stiga® Legacy

High quality, budget friendly design!

- 1/2" thick black table top with silk-screen striping
- 1.25" round steel legs and 2" casters
- 1.5" steel apron with yellow corner protectors
- 66" net and post set included
- Measures: 9'L x 60"W x 30"H
- Folds: 74"H x 60"W x 28"D
- Weighs 136 lbs., for indoor use only
- Call for freight quote- our regular shipping policy does not apply to this item.

C59129\$269.99 ea.



- .5" TOP
- 2" WHEELS



Stiga® STS 185

Sure to fit your budget!

- Competition grade 3/4" blue top
- 2" steel support apron
- 1.5" square steel self opening legs
- 3" ball bearing wheels
- Heavy duty chassis
- 66" net and posts
- Call for freight quote- our regular shipping policy does not apply to this item.

C59002\$549.99 ea.



- .75" TOP
- 1.5" LEGS
- 3" WHEELS

- Stylized corner pads
- Folds for playback and storage
- Measures 9'L x 5'W x 30"H
- Folds to 60"L x 28"W x 74"H
- Weighs 209 lbs.



Stiga® Synergy

QuickPlay chassis for fast assembly - from box to play in 30 minutes!

- 5/8" thick black table top for even bounce
- 1-3/4" self-opening steel legs
- 3" mag ball-bearing wheels with locks
- 2" steel apron with corner protectors
- 66" net and post set included
- For indoor use only
- Measures: 9'L x 60"W x 30"H
- Folds: 62"H x 60"W x 30"D
- Weighs 145 lbs.

C59128\$399.99 ea.



- .625" TOP
- 1.75" LEGS
- 3" WHEELS



Stiga® STS 285

Sets up in minutes!

- Competition grade 3/4" blue top
- 2" steel support apron
- 2" square steel self opening legs
- 5" ball bearing wheels
- Heavy duty chassis
- Stylized molded caster beam panel
- Ships by truck.

59001 FREE SHIPPING\$649.00 ea.

- .75" TOP
- 2" LEGS
- 5" WHEELS

- 66" net and posts
- Stylized corner pads
- Folds for playback and storage
- Measures 9'L x 5'W x 30"H
- Folds to 60"L x 28"W x 74"H
- Weighs 220 lbs.



Stiga® STS 385

Our most popular table!

- Competition grade 3/4" blue top
- 2" steel support apron
- 2" square steel self opening legs
- 5" ball bearing wheels
- Extra heavy duty chassis
- Cross brace supports & side panels
- Ships by truck.

59056 FREE SHIPPING\$799.99 ea.

- .75" TOP
- 2" LEGS
- 5" WHEELS

- Performance grade pivoting net
- Stylized corner pads
- Folds for playback and storage
- Measures 9'L x 5'W x 30"H
- Folds to 60"L x 28"W x 74"H
- Weighs 227 lbs.

TABLES

NEW

Joola® Connect Magnetic Tables

This magnetic table is one fourth the size of a regulation size table tennis table, making it great for smaller spaces.

The side aprons of the table are lined with magnets that easily connect to another JOOLA Connect Table.

Purchase multiple tables and the different configuration options are endless, making this great for game rooms, tailgates or rec centers!

Connect four JOOLA Connect Tables to make a regulation size table tennis table. Includes a custom sized net. Choose from singles, 4 or 6 table sets. 54" L x 30" W x 30" H. Item T66792 ships by truck.

Connect four JOOLA Connect Tables to make a regulation size table tennis table. Includes a custom sized net. Choose from singles, 4 or 6 table sets. 54" L x 30" W x 30" H. Item T66792 ships by truck.

- X59149 Light Green \$104.99 ea.
- X59150 Light Blue..... 104.99 ea.
- X59151 Red 104.99 ea.
- X59152 Midnight..... 104.99 ea.
- X66791 4 Table Set (Light Green, Light Blue, Red, Midnight)..... 349.99 set
- T66792 6 Table Set (2 Light Green, 2 Red, 1 Light Blue, 1 Midnight) 449.99 set



CONNECT FOUR JOOLA CONNECT TABLES TO MAKE A REGULATION SIZE TABLE TENNIS TABLE.

Joola® Drive 2500

Includes anti-tilting feature for safety!

- 25mm Competition grade MDF top
- 50mm warp resistant frame
- Auto folding legs
- 3" ball bearing smooth glide wheels
- Adjustable rubber feet
- Powder coated 2 piece undercarriage
- Tournament grade net and posts
- Folds for playback and storage
- Measures 9'L x 5'W x 31"H
- Weighs 214 lbs.
- Call for freight quote- our regular shipping policy does not apply to this item.

C59070 \$574.95 ea.



- 25mm TOP
- 3" WHEELS



- 1" TOP
- 3" WHEELS

Joola® Tour 2500

Includes auto folding legs!

- 50mm warp resistant frame
- Anti-tilting feature for safety
- Adjustable rubber feet
- Folds for playback and storage
- 3" ball bearing smooth glide wheels
- 1" Competition grade MDF painted top
- Call for freight quote- our regular shipping policy does not apply to this item.

C59071 \$574.95 ea.



- 7/8" TOP
- 4" WHEELS

Joola® Outdoor TR Table

Weather-proof table for outdoor play!

- 50mm warp resistant frame
- 7/8" thick aluminum plate table top
- 7/8" ball bearing hooded wheels
- Adjustable rubber feet
- Powder coated 2 piece undercarriage
- Call for freight quote- our regular shipping policy does not apply to this item.
- Weatherproof plastic net and posts
- Folds for playback and storage
- Measures 9'L x 5'W x 30"H
- Weighs 128 lbs.

C59104 \$999.99 ea.

ALTERNATIVE TABLES



Conversion Top

Convert your pool table into a table tennis table! Will fit on most 7' and 8' pool tables with side strips that help align the top properly and sponge rubber strips protect rails and hold top firmly in place. Made with a 1/2" black edge banded top with sturdy angular 3/4" gloss black rail and center mounted steel stiffeners for durability. Corner pads provide additional safety. Playing surface is 108"L x 60"W and folds for easy storage size of 54"L x 60"W. Weighs 129 lbs. Call for freight quote- our regular shipping policy does not apply to this item.
C25030 **\$259.99 ea.**

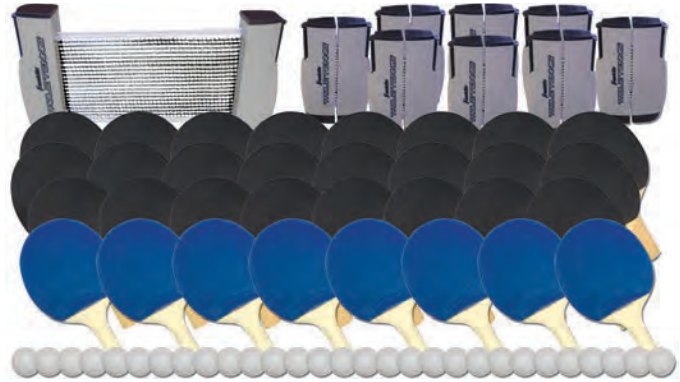

Table Tennis To Go Class Pack

32 player pack that is compact for the gym, rec room or class room! Nets easily attach to any rectangular table and adjust up to 75" in width! Includes 8 Table Tennis To Go Nets, 32 rubber face paddles, 144 recreational table tennis balls and a 24" x 36" mesh bag for storage or transport.
66407 **\$255.50 SALE \$214.99 pk.**



Mini Table Tennis Table

Minimizes playing area and storage space! You can still play a big game on this smaller table! Features 1" steel legs with side supports and a powder coat finish to support the 3/8" MDF laminated board. Net, 2 paddles and 2 balls are included. Legs fold down and table folds for easy storage! Measures 60"L x 30"W x 28"H and weighs 40 lbs. Ships by UPS
X59049 **\$139.99 ea.**



Table Tennis To Go

Includes net, paddles and balls! The expanding and retracting net posts are spring loaded to lock on to almost any surface area of a table top up to 75" wide and 1.75" thick. Includes 2 rubber faced paddles, 3 balls and carry bag.
59043 **\$19.99 SALE \$17.97 set**

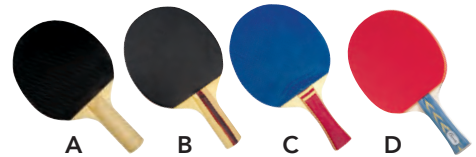

24 Player Class Pack

Choose from 4 different paddles. Each class pack includes 24 paddles, 1 gross of our most popular 59111 Economy Balls and mesh storage bag.
66119 A. Rubber Face Plastic Paddle Pack **\$126.90 SALE \$99.97 pk.**
66120 B. Rubber Face Staggered Wood Paddle Pack **121.90 SALE 92.97 pk.**
66121 C. Rubber Face Wood Paddle Pack **173.99 SALE 169.97 pk.**
66122 D. Sponge Face Wood Paddle Pack **239.00 SALE 194.97 pk.**



Slide-on Set

Extremely durable for institutional use. Metal slip on 66" net. Adjustable sliding posts.
59009 **\$17.99 set**



Premium Clipper Net & Post Set

Spring activated clip system! 72" premium cotton blend net with steel post assembly and tension system.
59062 **41.99**



Joola® Click Net-Post-Set

Metal post set and net with adjustable tension. High-quality net and post set with easy on/easy off clip design. For regulation size tables.
59079 **\$37.95 set**



Joola® Snapper Net-Post-Set

Clamp style post set and net with adjustable tension. Clip-style compact metal net set with high quality net and posts with vertical adjustment option. For regulation size tables.
59080 **\$28.95 set**



NEW

GoSports® XL Rec Balls

Over 25% larger than standard balls. Perfect for beginners. Seamless construction. 55mm. Box of 12.
59153 **\$12.99 bx.**

TABLE TENNIS BALLS



2 Star Bulk Pack
Excellent all play recreational ball!
Long lasting, good bounce. White.
Sold in a box of 144.
66419..... \$59.99 gr.



Stiga® 1 Star Rec Ball
Great quality for the price!
Made well, keeps shape, bounces consistently.
Sold in a box of 144.
59031..... \$45.99 gr.



ZONE Economy Recreational Table Tennis Balls
Long lasting durable balls. Ideal for game room play. White or orange. Sold in a box of 144.
59111 White..... \$38.99 **SALE \$30.97 gr.**
59112 Orange..... 38.99 **SALE 30.97 gr.**

Stiga® 1 Star Ball

USATT approved!
Official 40mm size. Top quality ball for games or practice. Set of 38 balls.
59067 White..... \$19.99 set
59069 Orange..... 19.99 set



iPong® 2 Star Ball

Bright color for easy eye tracking!
Great quality 40mm ball for the iPong machine or real game play. Box of 100.
59074..... \$23.95 bx.



PADDLES

Stiga® Reflex

Excellent speed and control.
Competition inverted rubber 1.6mm sponge. Concave handle and 5-ply blade. USATT approved.
59109..... \$16.99 ea.



Stiga® Aspire

Excellent control rating.
Inverted rubber and 1.5mm sponge. Concave handle and 5-ply blade. USATT approved.
59110..... \$11.99 ea.



Windsor™ 3-Star Paddle

Leather grip!
Pips-in sandwich rubber face with 1.5mm sponge for improved control, 5 ply laminated wood and leather wrapped flared handle.
59023..... \$8.89 ea.



Sponge Paddles

Premium quality.
5-ply sponge paddle with inverted rubber. Straight wood handle.
59013..... \$8.99 ea.



Rubber Face

5-ply laminated wood. Rubber face. 59015 has a staggered wood handle.
59015 A..... \$6.99 ea.
59014 B..... 3.29 ea.

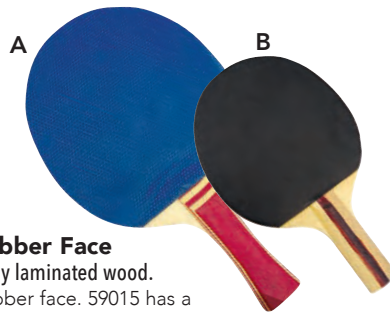

Stiga® Flow

Weather and shock resistant! Handle is made from thermoplastic elastomers and the blade is constructed of polypropylene and glass fiber.
59076 Green..... \$29.99 ea.
59077 Black..... 29.99 ea.



ZONE One-Piece Paddles

Guaranteed not to break under normal use.
No wood to splinter or rubber to peel, just a simple solid molded plastic performing paddle. Sold in sets of 6, one of each color.
59012 SET OF 6..... \$16.99 set



Sandface Paddle

5-ply laminated wood. Sandpaper faced with staggered wood handle.
59016..... \$3.25 ea.



Plastic Paddle

Constructed of molded plastic. Will not chip like wood. Virtually unbreakable. 59017 is 100% plastic with sandpaper like finish. 59018 has rubber face finish.
59017 A..... \$2.50 ea.
59018 B..... 3.50 ea.



PICKLE BALL



Franklin Pickleball-X® Tournament Net

Center support keeps the net taut 34" throughout gameplay!
 Official tournament size (36"H x 20"W). Steel frame for superior durability.
 Heavy duty carry bag. Easily sets up and breaks down for portability. End
 mounted adjustment straps maximize tension.
59127 \$143.99 ea.



Tournament Class Packs

Choose from 4 paddle styles and either 4 or 16 player sets.
 4 Player Sets include 4 paddles, 4 balls, 1 PickleNet™ and game rules. 16
 Player Sets include 16 paddles, 16 balls, 4 PickleNets™ and game rules.
X15247 Swinger 4 Player Tournament Class Pack \$199.99 pk.
X15030 Diller 4 Player Tournament Class Pack 199.99 pk.
X16825 Kanga 4 Player Tournament Class Pack 221.99 pk.
X16826 Kanga 16 Player Tournament Class Pack 849.99 pk.



**3.0 PickleNet™
 Tournament Net System**

Re-engineered to be lighter, more durable and easier to set up!
 Designed with a wide bent leg frame for increased stability, thick net with
 improved net sleeves and unique easy buckle net tensioning system. Frame
 is made from powder coated steel, sets up in just minutes.
 Includes nylon carry bag. Measures 22"L x 34"H.
X15994 PickleNet™ \$160.00 pk.
X54277 3 Pack 469.99 pk.

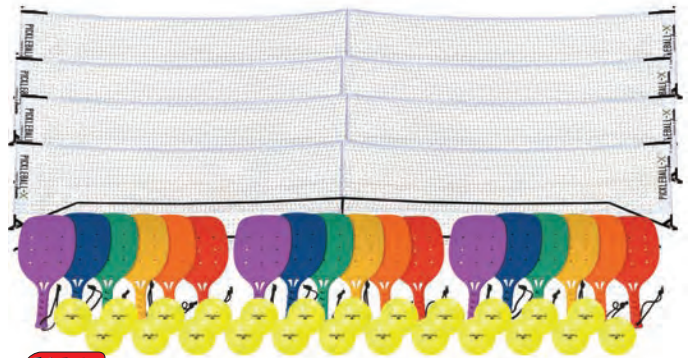

NEW

Pickleball 4 Court Package

Get up to four games going at once.
 Includes: (4) Franklin Pickleball-X® tournament nets with carry bags, (24)
 Franklin X-26 indoor pickleballs, and (18) Zone paddles. Nets measure 36"H
 x 20"W. Balls are USAPA approved with 26 beveled holes for efficient wind
 flow patterns and better aerodynamics indoors. Paddles are 15" one piece
 construction with wrist straps.
X66796 \$799.99 pk.

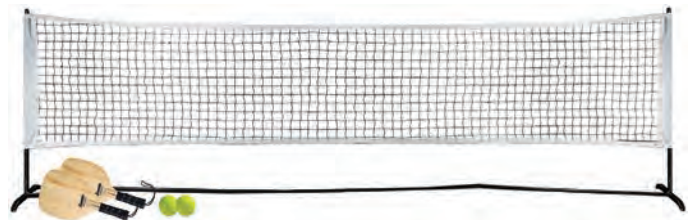

NEW

Franklin Half Court Starter Set

Official Starter Set of the US Open Pickleball Championships.
 This pickleball net package includes (1) 10 foot wide net (10ft x 3ft), (2)
 wooden pickleball paddles and (2) X-40 pickleballs. It's the perfect set to
 get you started in the sport, can be easily packed up and transported and is
 easy to assemble!
17373 \$58.99 set

PICKLE BALL



Onix Stryker Graphite Paddle
Oversized design with edge guard and tacky 4.25" grip. Graphite face with Nomex honeycomb core. Measures 15.5" L x 7.5"W and weighs 7.0-7.3 oz.
17198 \$69.99 ea.
17199 6 Pack 409.99 pk.



NEW
Rhino Edge Racquet
Solid plastic edging for maximum protection. Durable 7-ply hardwood. Eva padded grip for superior control. 5" handle. Weight: 11.8 - 12.2 oz.
17376 \$11.99 ea.
56026 6 Pack 64.99 pk.



Onix Recruit 2.0 Paddle
Higher end wood paddle. Constructed of durable 7-ply birch wood with and overgrip handle for comfort and great control while playing.
17210 \$29.99 ea.
17211 6 Pack 164.99 pk.



NEW
Franklin® Aluminum Jet Paddle
Dual plated aluminum surface. USAPA approved. Comfort cushion grip and durable edge guard. 6" handle. 7.75"W x 16"H. Weight 11.7 - 12 oz.
54275 \$24.99 **SALE \$19.97 ea.**
54276 6 Pack 119.82 **SALE 114.97 pk.**



NEW
Franklin® Activator Paddle
Durable 7-ply wood construction. USAPA approved. Comfort cushion grip and strong edge guard. 5" handle. 8"W x 16"H. Weight 10.6 - 11 oz.
17284 \$12.49 ea.
56025 12 Pack 139.99 set



Kanga Paddle
Excellent institutional paddle. 7 layer maple design with composite grip and nylon strap. Measures 15.5"L x 7"W.
16827 \$10.99 ea.
16828 12 Pack 119.99 pk.
66828 20 Pack 189.99 pk.



Swinger Paddles
Introductory hardwood paddle. Crafted with 5 ply hardwood with a synthetic grip and rope style safety strap. Measures 15"L x 7 3/4"W.
15117 \$11.99 ea.
15118 12 Pack 130.99 pk.
66827 20 Pack 199.99 pk.



Diller Paddles
Made of durable 7 ply hardwood with a straight wrapped handle and rope style safety strap. Measures 15"L x 7"W.
15032 \$12.99 ea.
15249 12 Pack 148.99 pk.
66826 20 Pack 204.99 pk.

NEW

Franklin® X-40 Pickleballs
USAPA outdoor tournament approved. Forty precisely drilled holes create a balanced, consistent flight pattern. Rotationally molded and high quality pigments for superior construction and visibility. Ideal for indoor/outdoor use.
17374 Optic Yellow 12 Pack \$29.99 dz.
17375 Pink 12 Pack 29.99 dz.



Pickle-Ball® Dura Fast 40 Balls

Our most popular ball!
Manufactured as a seamless one piece ball with smaller holes for fast and consistent play. Ideal ball for indoor or outdoor use.
16043 White \$28.99 dz.
16044 Yellow 28.99 dz.
16046 Orange 28.99 dz.



NEW

Franklin® X-26 Pickleballs
USAPA indoor tournament approved. Twenty-six precisely beveled holes create efficient wind flow patterns and better aerodynamics for indoor conditions. Expertly balanced. High quality pigments for superior visibility indoors.
17371 Optic Yellow 12 Pack \$29.99 dz.
17372 Blue 12 Pack 29.99 dz.



Pickle-Ball® Big Hole Balls

Designed to slow play down!
The larger holes create more drag for slower play and allows more finesse shots. Ideal for indoors or for players young and old who want longer rallies.
16135 White \$28.99 dz.
17194 Yellow 28.99 dz.
17195 Orange 28.99 dz.
17196 Green 28.99 dz.

PURE Pickleball P7 Ball

An extremely durable ball.
The unique combination of plastics and design ensure fast play without compromising the fun of the game. For indoors or outside. Made in the USA.
17197 \$29.99 dz.



PADDLE GAMES



ZONE Plastic All-Purpose Paddle Set

15" paddles for all sorts of paddle play.

Molded one-piece design with attached wrist strap.

15072 SET OF 6 \$39.99 **SALE \$29.97 set**



Pick-A-Paddle Plastic Paddle

An indestructible one piece molded high-impact plastic paddle.

Available in official or junior size. The official paddle has a playing surface of 9" x 7.5", while the junior size is 8" x 6.75". Each paddle includes a wrist strap.

15057 SET OF 6 Official Size Colored Set 15" \$53.99 set

15058 SET OF 6 Jr. Size Colored Set 13" 39.99 set



AVAILABLE IN 2 SIZES

ZONE Foam Paddles

Ideal for all types of foam and plastic balls!

Ethafoam head with plastic handle. Lollipop Paddles have an 8" head and a 9" long handle. The Badminton Paddles have a slightly larger 9" head with an 11" long handle. Sold in set of 6.

15454 SET OF 6 9" Lollipop Paddles..... \$51.99 **SALE \$42.97 set**

15460 SET OF 6 11" Badminton Paddles..... 68.99 **SALE 55.97 set**

Oversized Shuttlecocks

In assorted colors!

A 3.5" plastic shuttle with oversized sponge tip. Colorful over sized shuttlecock makes it easier to track during game play. Sold in dozens.

34020 \$15.99 **SALE \$13.97 dz.**



* Full **CHOKING HAZARD** descriptions on page 355.



ZONE Balloon Badminton Paddles

Perfect for balloons, tendril, fleece and other lightweight balls.

An alternative to traditional badminton paddles, these have a lightweight 11" diameter wire frame with nylon cover, a strong micro mesh hitting surface, and contoured foam handle. 18" long. Includes 30 balloons. **CHOKING HAZARD (6) - BALLOON.** Not for under 8 yrs.*

15993 SET OF 6 with 30 balloons..... **\$84.99 set**

10217 7" Balloons (144ct)..... **7.99 bag**

10216 9" Balloons (144ct)..... **9.99 bag**

10215 11" Balloons (144ct)..... **17.99 bag**

Basic Wood Paddle

Don't let the price fool you!

The 3 ply construction makes the paddle strong yet still lightweight for all age groups. Use with all types of balls, from foam to pickleball.

Measures 16"L x 8"W with a cushioned foam grip and wrist strap.

15285 **\$9.99 ea.**



Junior Plastic Paddles

Perfect for beginners!

This one piece molded plastic paddle is great for pickle ball or any other type of paddle game. The 8" x 6-3/4" junior size is perfect for beginner play with durable 1/2" thick simulated strings and safety strap. Available in a set of 6 consisting of 1 of each color.

15014 SET OF 6 **\$19.99 SALE \$16.97 ea.**



Foam Feathered Shuttlecock

True flight off the hand or paddle!

Sturdy foam base coated with heavy duty vinyl. Smooth flight aided by the long feathers in bright colors for easy eye tracking. Overall height 13".

15538 Set of 4..... **\$19.99 set**



PADDLE GAMES



PaddleZlam™

The ultimate anywhere game!

An action packed 4-person paddle game that combines the skills of Kanjam and pickleball. Teams of two face off to serve, assist and ZLAM the ball into the goals on the two cones with the paddles. Be the first team to 21 points. Set includes: 4 Pickleball paddles, 2 Pickleballs, 2 gaming cones, carry bag and instructions.

17281 \$59.99 set



Smashminton Set

Great fun- anywhere!

The metal 17.5" long mini racquets have oversized round heads and cushion grips. Birdies are 3" long with a foam tip.

16815 \$11.99 set

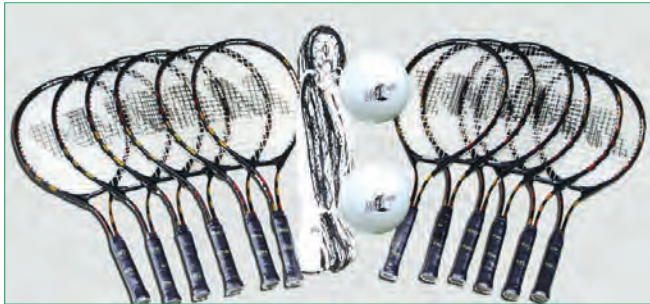

Racquet, Ball & Net Class Pack

Everything you need to get a game going on one court!

You get 2 Eclipse Balls, a 32' x 3' recreational volleyball net and 12 of our 24" aluminum junior tennis racquets.

66237 \$284.50 SALE \$229.97 pk.



Eclipse Ball™

A fast moving court game for 2 to 6 players per team!

It is played on a volleyball court indoors or out. The 6.5" black/white ball spins with a corkscrewing effect making play more challenging. This game is full of all the rules that everyone wishes were in volleyball, badminton and tennis. An excellent introductory activity for tennis and other paddle racket games. A great game for ages 9+. A set of rules are included with each ball.

15203 \$13.97 SALE \$13.97 ea.

17157 Set of 6 Eclipse Balls™ 79.99 SALE 73.97 set



Zume Portable Badminton Set

Freestanding base sets up on any surface in seconds - no tools or stakes required!

Ultra-portable and nearly instant. Base doubles as a lightweight carrying case. Includes: four rackets (two red, two green), two shuttlecocks, net, and carrying case. Two to four players (ages 6+).

17286 \$59.99 set



Zume® Pickleball

Quick and easy to set up!

Ideal for recreational play or for smaller sizes and courts for younger players.

Great for drills and training. Includes easy to assemble 12' long steel frame with slide on net, 2 paddles, 2 balls and carry case.

X16834 \$59.99 set

30 SPEEDER™
BIG PACK INCLUDES:
10 MATCH • 10 FUN • 10 HELI

SPEEDERS™

Match Speeder™

- Fast play
- Perfect for shorter distance

SUPER 10

SUPER 10 FUN

Fun Speeder™

- Slow play
- More control
- Available separately

Heli Speeder™

- Beginner play
- Fun for all
- Available in kits only

SPEEDERS GLOW
IN THE DARK
WITH SPEEDLIGHTS!

Speedminton®

The take anywhere racquet game!

Sets up in seconds! Basic game play consists of players defending their area- no nets, just use the included boundary markers. Games are played to 15 points and points are scored when the speeder touches the ground in the opponents area or is hit out of bounds. Racquets are made of extruded aluminum and are lightweight with an oblong head- like a mix between a tennis and squash racquet. The Speeders are very durable with a larger head to hit and skirt design for accurate striking and consistent play.

34053 2 Racquet Set- 2 racquets, 3 Speeders™, goal markers & bag \$39.99 set

34071 Super 10 Set- 10 racquets, 30 Speeder™ Big Pack, 40 goal markers & bag 209.99 set

34072 Super 10 Fun Set- 10 racquets, 10 Heli Speeders™, 2 Speedlights & bag 159.99 set

34044 Fun Speeders™- slow play, better control set of 20 45.99 set

34045 Match Speeders™- fast play for competition set of 20 46.99 set

RACQUETS



ZONE Spike 200
High quality entry level PE racquet.
 • Premium aluminum head/steel shaft
 • Nylon strings, wide body
 • Synthetic non-slip grip
 • 26" Long
 49083 SET OF 6 **SALE \$46.97 set**



Carlton™ Aeroblade 2000 Racquet
High performance racquet.
 • Premium steel head/steel shaft
 • Multi-filament braided strings
 • Synthetic non-slip grip
 • 26" Long, Weight 4.2 oz.
 34057 **\$9.99 ea.**



Carlton™ Aeroblade 3000 Racquet
With a maximized sweet spot!
 • Alloy head/graphite shaft
 • Multi-filament braided strings
 • Synthetic non-slip grip
 • 26" Long, Weight 3.2 oz.
 34054 **\$12.99 SALE \$10.97 ea.**



Palos Titan™
23 year track record in PE programs!
 • Stainless steel head/steel shaft
 • Lonfibre strings- last 10x longer
 • Synthetic non-slip grip
 • 26" Long, Weight 3.8 oz.
 34001 ... **\$19.99 SALE \$15.97 ea.**



Club Racquet
An excellent elementary racquet.
 • Tempered steel head/steel shaft
 • Multi-filament braided strings
 • Synthetic non-slip grip
 • 26" Long, Weight 3.9 oz.
 34007 **\$7.99 ea.**



Wilson® Matchpoint Pro Racquet
Oversized 53" sweet spot.
 • Titanium head/aluminum shaft
 • Braided nylon strings
 • Soft, traction grip
 • 26" Long, Weight 4.2 oz.
 34076 **\$15.99 ea.**



Yonex® Basic Racquet
Power balanced with finesse.
 • Steel head/steel shaft
 • Nylon strings
 • Synthetic non-slip grip
 • 26" Long, Weight 3.6 oz.
 34034 **\$14.99 SALE \$12.97 ea.**



Carlton® 4.3 Racquet
Beginner competition racquet!
 • Alloy head/steel shaft
 • Nylon strings
 • Synthetic non-slip grip
 • 26" Long; Weight 3.8 oz.
 34030 **\$13.99 ea.**



Black Knight™ Sceptre
Competitive P.E. racquet!
 • Aluminum head/steel shaft
 • Lonfibre strings
 • Non-slip grip
 • 26" Long, Weight 3.8 oz.
 34050 **\$16.99 ea.**



Yonex® B-6500™ Racquet
Large sweet spot!
 • Aluminum head/steel shaft
 • Nylon strings
 • Synthetic non-slip grip
 • 26" Long, Weight 3.5 oz.
 34070 **\$18.99 ea.**



Carlton™ Aeroblade 4000 Racquet
Generate more power for great shots!
 • Titanium alloy head/graphite shaft
 • Multi-filament braided strings
 • Synthetic non-slip grip
 • 26" Long, Weight 3.2 oz.
 34056 **\$23.99 ea.**



Black Knight™ The Beast™
Designed for the P.E. market!
 • Aluminum head/steel shaft
 • Lonfibre strings
 • Non-slip double grip
 • 26" long, Weight 4.2 oz.
 34058 **\$24.99 ea.**

RACQUETS



6 Color Twin Blade Racquets
Double twin shaft for strength!
• Steel head/steel shaft
• Nylon strings
• Vinyl PU grip
• 25.75" Long; Weight 5.0 oz.
34068 SET OF 6 \$61.99 set



BEAT ME I WON'T BREAK



BDMI American P.E. Racquet
The frame bends, not breaks.
• Aluminum head/aluminum shaft
• Nylon strings
• Synthetic non-slip grip
• 26" Long, Weight 4.8 oz.
34009 \$16.99 SALE \$13.97 ea.



Steel Twin Racquet
Double twin steel shaft!
• Steel head/steel shaft
• Nylon strings
• Leather grip
• 26" Long, Weight 5.2 oz.
34004 \$12.99 ea.



ZONE Victory-100 Racquet
High quality/low cost racquet.
• Premium steel head/shaft
• Nylon strings
• Synthetic non-slip grip
• 26" Long
41155 SET OF 6 SALE \$35.97 set

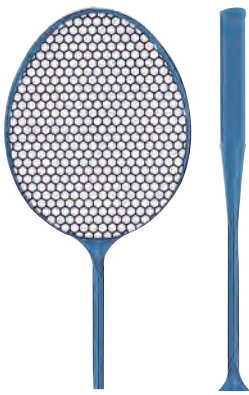

Molded Racquet
Tough one-piece construction!
• Flexible plastic head/shaft
• Molded plastic strings
• Molded plastic grip
• 26" Long, Weight 5 oz.
34012 \$9.99 ea.



Pick-A-Paddle™ Racquet
Molded bendable plastic shaft!
• Steel head/molded plastic shaft
• Nylon strings
• Molded plastic handle
• 26" Long, Weight 4.7 oz.
34013 SET OF 6 \$84.99 set



BR-40 Steel Racquet
Lightweight, yet extra strong.
• Tempered steel frame
• Nylon coated steel strings
• Dimpled leather grip
• 26" Long
34003 \$12.99 ea.



Economy Racquet
An excellent inexpensive racquet.
• Tempered steel head/steel shaft
• Nylon strings
• Synthetic grip
• 26" Long, Weight 4.0 oz.
34008 \$4.99 ea.

JUNIOR RACQUETS



Junior Racquet
Shorter 22" size racquet.
• Tempered steel head/steel shaft
• Nylon strings
• Synthetic grip
• 22" Long, Weight 3.5 oz.
34039 \$6.99 ea.



Mini Racquet
Shorter racquet for younger players!
• Tempered steel head/steel shaft
• Nylon strings
• PVC grip
• 20" Long, Weight 4.0 oz.
34000 \$7.99 ea.



Intermediate Racquet
Perfect for entry level Jr. High!
• Tempered steel head/steel shaft
• Nylon strings
• Synthetic grip
• 24" Long, Weight 4.5 oz.
34006 \$7.99 ea.



ZONE Plastic Junior Badminton Racquets
Easy to control for more success!
• One piece plastic construction
• Molded plastic strings
• Molded plastic grip
• 17.25" Long, Weight 3.0 oz.
34065 SET OF 6 SALE \$12.97 set

SHUTTLECOCKS

Carlton® F2 Synthetic Shuttlecocks

High visibility yellow!
A top quality synthetic shuttlecock incorporating an ultra durable nylon construction and natural cork base. Medium speed. Sold in tubes of 6.
34911 \$12.99 tb.



Wilson Pro 80 Shuttlecock

Top grade natural feathers!
Premium natural cork base provides consistent flight and speed. Official IHSA shuttlecock. Medium Speed. Sold in tubes of 12.
34067 \$32.99 tb.



Yonex® Mavis 300

Durable nylon skirt and natural cork head. Performs much like the feather shuttlecocks but with longer lasting life. Approved by the U.S.B.A. Medium speed. Sold in tubes of 6.
34901 White \$11.99 tb.
34913 Yellow 11.99 tb.



Carlton® C-100

An uncompromising beginner shuttlecock. Superior construction at an economical price. Durable PVC base with injection molded white nylon skirting. Holds up to everyday play. Medium speed. Sold in tubes of 6.
34900 . \$8.99 SALE \$7.97 tb.



Carlton® T-800 Tournament

Choose from two speeds!
All are made with stiff fluted nylon skirts and PVC synthetic bases. Competition quality play. Sold in tubes of 6.
34902 Medium- white w/blue ... \$10.50 SALE \$8.97 tb.
34903 Medium- yellow w/blue ... 10.50 SALE 8.97 tb.
34906 Fast- white w/red 10.50 SALE 8.97 tb.



Carlton F1 Ti Shuttlecock

Medium speed.
Premium synthetic skirt with natural cork base. High quality at a great price. Sold in tubes of 6.
34074 Medium- White \$13.99 tb.
34075 Medium- Yellow 13.99 tb.



Multi-Colored Shuttlecocks

For indoor/outdoor play.
A six pack of synthetic shuttlecocks in assorted colors. Medium speed.
34016 \$3.50 tb.



Falcon™ Shuttlecocks

Outstanding quality at a competitive price.
Nylon skirt with a cork base in medium speed. Long lasting, responsive play. Sold in tubes of 6.
34912 \$9.99 SALE \$7.47 tb.



Tournament Grade Shuttlecock

An excellent all purpose P.E. shuttlecock. Affordable with great playability. Constructed with a very durable soft nylon ribbing. PVC base. Medium speed. Sold in tubes of 6.
34011 \$7.79 tb.



Shuttlecock Class Pack

In six eye catching colors!
Made with plastic feathers and rubber tips. Pack includes 6 of each color: red, orange, yellow, green, blue and purple.
34069 \$25.99 pk.



Giant Fun Bird

Now in 6 colors!
The larger 5" size makes for a slower play that can easily be adapted to any type of racquet. Made of a resilient material that can be used indoors or out.
15598 SET OF 6 \$8.50 SALE \$6.97 set

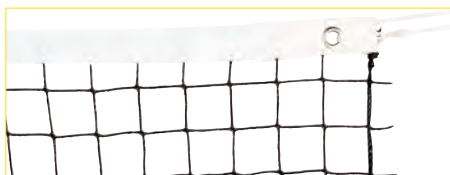

Recreation Net

An economy net.
• 1" tetron headband, 21'L x 2 1/2" H
• 1 mm polyethene, 1 1/2" square mesh
• Unfinished side and bottom rope cable
34023 \$11.99 ea.



Tournament Net

Tournament quality!
• 1 1/2" vinyl headband, 21'L x 2 1/2" H
• 15 ply brown nylon netting, 3/4" square mesh
• Side and bottom taped with poly rope cable
34022 \$22.99 SALE \$16.97 ea.



Championship Net

For the serious player.
• 2" vinyl headband, 21'L x 2 1/2" H
• 18 ply premium nylon netting, 3/4" square mesh
• Side and bottom taped with nylon rope cable
34024 \$25.99 ea.

PORTABLE NETS & CLASS PACKS

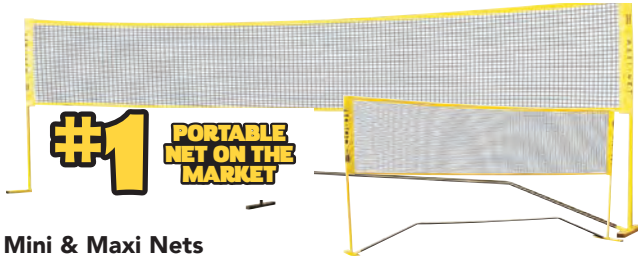

Mini & Maxi Nets

No tools needed for setup!

The Mini-Net and Maxi-Net portable net systems are revolutionary in quality, portability and price! Both nets set up and take down in just seconds with no tools needed and no bases to fill with sand or water. Heights are adjustable from 30"-52" for a variety of activities and lead up games. Both systems include a zippered carry case. The Mini-Net is 10' long with a 30" high net and the Maxi-Net is 18' long with a 30" high net.

- X15043 Maxi-Net, Adjusts from 30"-52"H x 18'L \$119.99 **SALE \$109.97 ea.**
- X15039 Mini-Net, Adjusts from 30"-52"H x 10'L 109.99 **SALE 99.97 ea.**
- 15133 Maxi-Net, Replacement net 36.99 ea.
- 15085 Mini-Net, Replacement net 22.99 ea.



TWO UNIQUELY LARGER PORTABLE NETS WITH ADJUSTABLE HEIGHTS FROM 30" TO 61"!

Port-A-Net

A quick and easy 14' or 20' net system that can be set up anywhere.

Sets up in minutes. Both units have a 30" net that can be adjusted to a full 61" height for other over the net sports. Durable powder coated steel frame requires no extra weight for stability. The nylon-web adjustable strap at the top ensures quality net tension. The entire system fits easily into a durable nylon bag included.

- X41103 30"-61" x 20' Net \$129.99 ea.
- X41104 30"-61" x 14' Net 119.99 ea.

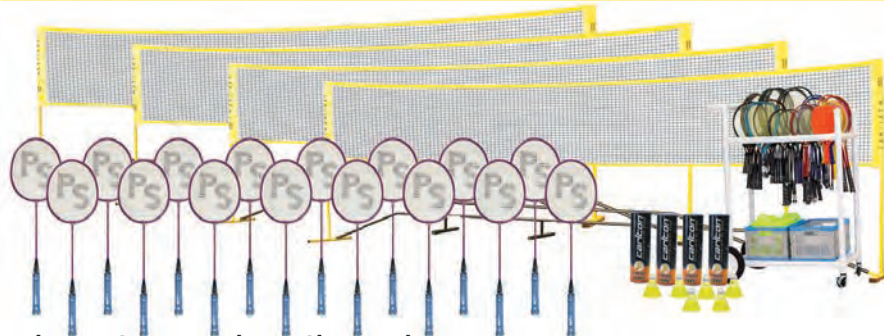

Deluxe 4 Court 16 Player Class Packs

Packs now available for middle school or high school players!

The Maxi Nets are 18' long, can adjust from 30"-52" in height and sets up in minutes. The Middle School Pack features our popular Carlton Aeroblade racquet and Falcon shuttlecocks- both ideal for that age group. The High School Pack contains our best selling Palos Titan racquet and Carlton T-800 medium play shuttlecocks. The Equipment Cart is not included in the packs and must be ordered separately.

- X41102 Equipment Cart Measures: 32.5"L x 19"W x 35"H \$229.99 **SALE \$214.97 ea.**

Middle School Deluxe 16 Player Pack

Contents:

- 4 ea. 15043 Maxi Nets 18'L
- 16 ea. 34057 Carlton Aeroblade 2000 Racquets
- 4 tbs 34912 Falcon Shuttlecocks

- X34060 \$678.70 **SALE \$601.97 set**

High School Deluxe 16 Player Pack

Contents:

- 4 ea. 15043 Maxi Nets 18'L
- 16 ea. 34001 Palos Titan Racquets
- 4 tbs 34903 Carlton T-800 Medium Yellow Shuttlecocks

- X34061 \$841.80 **SALE \$729.97 set**

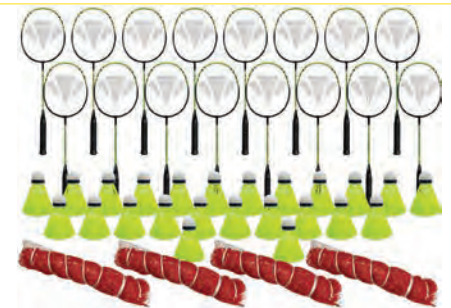

Middle School 16 Player Class Pack

You supply the uprights, we've got the rest!

We've chosen the most popular racquets and shuttlecocks for the age group to make this pack. The Carlton™ Aeroblade is the ideal PE racquet and the Falcon shuttles are durable with nice performance. Includes Tournament Nets as well.

- Contents:
- 16 ea. 34057 Carlton Aeroblade 2000 Badminton Racquets
 - 4 tbs 34912 Falcon Shuttlecocks
 - 4 ea. 34022 Tournament Nets
- 34062 \$269.99 pk.

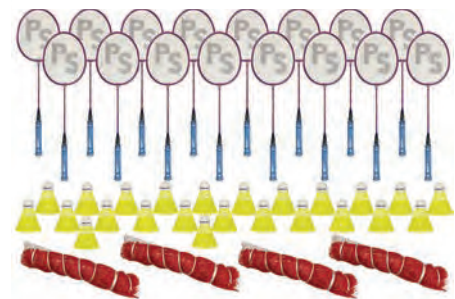

High School 16 Player Class Pack

Competition quality!

Using our popular Palos Titan™ racquet with Carlton T-800 shuttlecocks for a great mix of performance play with high quality equipment. Includes tournament net as well.

- Contents:
- 4 tbs 34903 Carlton Medium Speed Yellow Shuttlecocks
 - 16 ea. 34001 Palos Titan Badminton Racquet
 - 4 ea. 34022 Tournament Nets
- 34063 \$453.80 **SALE \$299.97 pk.**



ZONE Racquet Cart

Assembles quickly and holds up to 100 racquets!

Ideal for tennis or badminton, this cart is made from high impact PVC with smooth rolling swivel casters. Includes a fabric bag for ball storage and other accessories. Measures 43"L x 19"W x 36"H.

- X36192 \$199.99 ea.



Junior Racquet Pack

Includes:

- 16 ea. 34000 Mini 20" long Racquet
- 4 tbs. 34016 Multi-Colored Shuttlecocks
- 2 34022 Tournament Net

- 34914 \$179.99 pk.

TENNIS RACQUETS



2 YEAR GUARANTEE

Palos Pythonic™

An ideal Jr. High and H.S. P.E. racquet.

- Midsize head
- Aluminum frame/head
- Nylon strings
- Non-slip grip, asst. sizes.
- 27" Long, Weight 11 oz.

41101 .. \$19.99 **SALE \$15.97 ea.**



NEW

Wilson® Intrigue

Lightweight composition for superior control.

- 113 sq. in. head size
- Stop Shock pads absorb unwanted vibration
- Nylon strings
- Non-slip grip, size 2
- 27" Long; 9.7 oz.

41157 \$26.99 ea



Dunlop Nitro 27

Ideal for youths and adults.

- Oversized head
- 110 sq. in. large sweet spot
- I-Beam Alloy frame/head
- Nylon strings
- Non-slip grip; asst. sizes
- 27" Long; 9.7 oz.

41153 \$17.99 ea.



Wilson® Energy™ XL Racquet

V-matrix technology for increased power!

- Super-oversized head, wide body
- Titanium-alloy V-Matrix frame
- Synthetic leather grip
- Nylon strings
- 27.5"L, 10 oz.

41156 \$24.99 ea.

JUNIOR SIZE RACQUETS



Jr. Tennis Racquets

A 21" plastic racquet ideal for beginners!

Use with a number of different types of soft foam tennis balls. Lightweight and easy to control. Sold in **SET OF 6.**

41130 **SALE \$16.97 set**



Junior 21" Racquet

An ideal size for grades K -3rd grades.

- Midsize head
- Aluminum frame/head
- Nylon strings
- Non-slip grip, asst. sizes.
- 21" Long, Weight 7.4 oz.

41030 **SALE \$16.97 ea.**



Junior 24" Racquet

An excellent size for grades 4th- 6th grades.

- Midsize head
- Aluminum frame/head
- Nylon strings
- Non-slip grip, asst. sizes.
- 24" Long, Weight 8.3 oz.

41029 \$17.99 ea.



Dunlop Nitro Racquets

Ideal beginner racquets.

- Midsize head
- I-Beam alloy construction
- Nylon strings
- Non-slip grip; asst. sizes

41149 21"; 7.4 oz. **\$16.99 ea.**

41150 23"; 7.7 oz. **16.99 ea.**

41151 25"; 8.4 oz. **16.99 ea.**



MAC-T® Junior Tennis Racquets

In colors for group play!

- Oversized head
- Aluminum frame/head
- Nylon strings
- Non-slip grip
- 23" Long, 7.7 oz.

41099 **SET OF 6** \$97.99 set

Tournament Tennis Net

2.8mm Braided polyethylene netting.

- 42'L with 2.8mm braided polyethylene netting
- 2.5" double reinforced headband
- 6 rows of heavy nylon stitching
- 6mm vinyl coated steel cable
- Taped nylon bottom and side pockets and dowels

41036 \$139.99 ea.



Competition Tennis Net

3 Year All Weather

Unconditional Guarantee!

- 3.8mm knotless polyethylene netting
- Netting sealed with polyester coating to withstand weather
- 2.5" reinforced headband
- Vinyl coated steel top cable
- Stitched nylon sides and bottom
- Side pockets with dowels

41001 \$179.99 **SALE \$159.97 ea.**



TENNIS BALLS



Dunlop® SpeedBall

One of the most durable high-bounce foam balls on the market! There's just something special about the foam that lets this ball bounce better, keep its shape, not tear or wear out. High density foam, 2 tone for tracking spin and 3.5" diameter.
 41020 \$44.99 **SALE \$39.97 dz.**



60 PACK

ZONE 1 Pressureless Training Balls

Ideal for teaching, ball machines and general practice. Durable natural rubber core and heavy duty felt make these balls ideal for all court types. Yellow. 60 balls per bag.
 49084 5 Dozen \$84.99 dz.
 49090 1 Dozen 15.99 dz.



Pressureless Tennis Balls

Guaranteed never to lose their bounce. Our number one selling practice ball. Perfect for practice and P.E. classes.
 41025 \$16.99 dz.



FREE SHIPPING ON CASES



Wilson® Extra Duty Tennis Ball

Top quality competition ball for all your needs. Exclusive DuraWeave felt for ideal hard core. Sold three balls to a can or 6 dozen case pack 24 cans.
 41024 Wilson® X-duty yellow \$3.99 cn.
 41037 Wilson®-6 dz case (24 cans) 86.99 cs.



Penn® Championship Tennis Balls

Ideal for teaching, practicing or competitive play. Extra heavy duty yellow felt with high bounce play. Sold in a 6 dozen ball case pack of 24 cans.
 X41032 Penn®-6 dz case (24 cans) \$89.99 cs.



Penn® Practice Tennis Balls

A pressurized high bounce practice ball. Excellent choice for a practice ball. Lively bounce with Penn® quality. Sold three balls to a can.
 41022 Penn Practice \$3.69 cn.
 X41095 Penn®-6 dz. Case (24 cans) 69.99 cs.

CARTS



Racquet Caddy with Basket

Holds up to 100 racquets and 50 tennis balls! Made from PVC with 3" non-marring casters. Features a push/pull handle and removable plastic basket. Measures 43"L x 19"W x 41"H.
 X36084 \$215.99 ea.



ZONE Racquet Cart

Holds up to 100 racquets! Ideal for tennis or badminton, this cart is made from high impact PVC with smooth rolling swivel casters. Includes a fabric bag for ball storage and other accessories. Measures 43"L x 19"W x 36"H.
 X36192 \$199.99 ea.



Big Wheel Racquet Cart

Oversized 10" rear wheels for all terrain! Constructed of impact resistant PVC with 3" swivel front casters. Includes 2 folding baskets for balls. Measures: 32.5"L x 19"W x 35"H
 X41102 \$229.99 **SALE \$214.97 ea.**

PRACTICE TENNIS BALLS



Gamma Quick Kids™ 36 Foam Ball
For ages 6 and up on a 36' court.
This oversized ball is 75% slower than a standard ball for easy learning of the game. USTA approved for 10 & Under Tennis.
41144 12 Pack \$34.99 dz.



Gamma Quick Kids™ 36 Ball
For ages 8 and under on a 36' court.
This oversized ball is 75% slower than a standard ball for easy learning of the game. USTA approved for 10 & Under Tennis.
41146 Bucket of 24 \$44.99 pk.



Wilson US OPEN® Balls
For 10 and Under tennis.
USTA Approved. Red ball is oversized and 75% slower. Orange Dot is official size and 50% slower. Green Dot is official size and 25% slower.
41109 Red Ball 36 Ball Pack \$55.99 pk.
41110 Orange Ball 48 Ball Pack 69.99 pk.
41114 Green Dot 36 Ball Pack 49.99 pk.



Gamma Quick Kids™ 60 Ball
For ages 10 and under on a 60' court.
This official size ball is 50% slower than a standard ball. USTA approved for 10 & Under Tennis.
41147 Bucket of 48 \$74.99 pk.



Gamma Quick Kids™ 78 Ball
For ages 11 and adult beginners on a 78' court.
This official size ball is 25% slower than a standard ball.
41148 Bucket of 48 \$74.99 pk.



Tennis Trainer Ball
Adjustable-pressure slow bounce ball.
A perfect oversized teaching tennis ball that weighs and bounces just like a tennis ball except slower. Depending on how much the ball is inflated will determine how fast it bounces.
15202 \$5.29 ea.

PALOS Foam Ball Set
Bright yellow color helps with tracking!
High density 2.75" diameter foam with a thick, durable skin coating and molded seams. Available in a set of 6.
66775 \$9.99 set

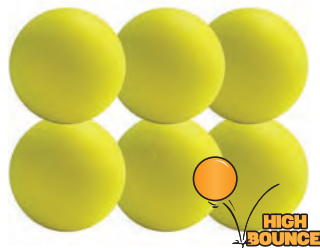

PALOS Uncoated Foam Multi-Use Balls
An affordable multi-purpose bouncy foam ball!
Our own version of high bounce tennis balls at an economical price. Available in yellow only.
10074 2.75" \$1.69 ea.
10076 3.5" 2.49 ea.



Two-Tone Foam Balls
An affordable multi-purpose bouncy foam ball!
Our own version of high bounce tennis balls at an economical price. Balls come in assorted colors.
10221 2.75" \$2.89 ea.
10222 3.5" 3.99 ea.

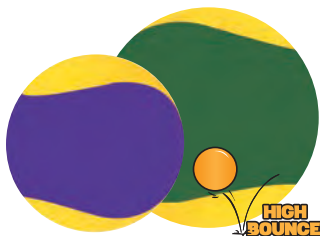

Wilson® Starter EZ Nets™
Versatile system for a variety of activities!
Use for tennis, paddle games or badminton.
Metal frame with powder coat finish and durable netting sets up and tears down fast.
X41105 10'L x 36"-72"H \$99.99 **SALE \$89.97 ea.**
X41106 18'L x 36"H 139.99 **SALE 129.97 ea.**



Mini & Maxi Nets
Heavy duty steel frame snaps together quickly no tools needed!
Net heights adjust from 30-52 inches for a variety of activities and lead up games. Both systems include a zippered carry case and a net.
X15039 Mini-Net, Adjust from 30"-52"H x 10'L \$109.99 **SALE \$99.97 ea.**
X15043 Maxi-Net, Adjust from 30"-52"H x 18'L 119.99 **SALE 109.97 ea.**
15085 Mini-Net, Replacement net 22.99 ea.
15133 Maxi-Net, Replacement net 36.99 ea.

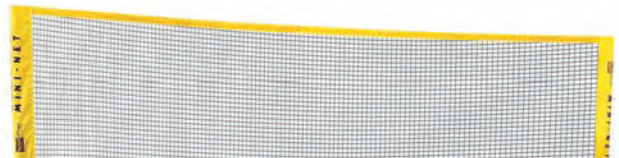

TENNIS SETS

Middle/H.S Tennis Class Pack

Ideal for developing ground strokes!

Develop proper body and racquet positioning by using the Pressureless Tennis balls for real time play. The Pythonic racquets have a midsize head and measure 27" long with a non-slip grip.

Contents:

- 24 ea. 41101 Pythonic Racquets • 1 ea. 36210 Equipment Bag
- 5 dz. 49084 The Zone Pressureless Tennis Balls

66490 \$587.00 **SALE \$455.97 pk.**

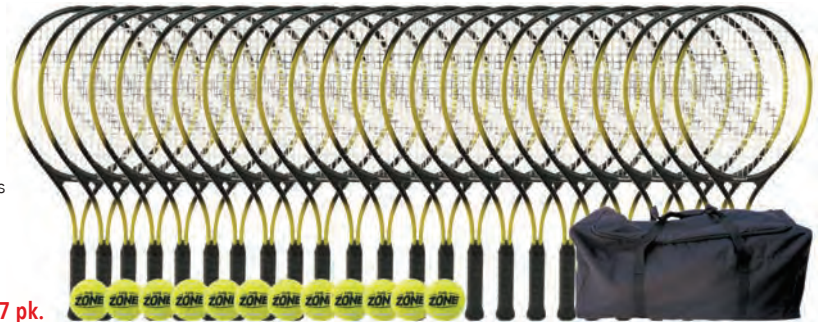

Champion Portable Tennis Set

Portable instant tennis match set.

Ideal for building skills, the 12' long net quickly sets up and breaks down anywhere. Heavy steel construction frame with a durable fitted net. Includes two 21" racquets, 2 tennis balls, and storage case.

X41142 \$79.99 ea.



Portable Tennis Set

Everything you need to play tennis anywhere!

Net stands 15' long with sleeved ends, 1" top tape, Velcro® net tensioners and 1" black mesh netting with a 32" playing height. Frame is made from 7/8" steel with powder coat finish and 36" wide base for stability. Includes 2 plastic racquets, 1 foam ball and carry bag.

X41136 \$99.99 set



COURT ACCESSORIES

Water Remover

Designed to push water off tennis courts or other hard surfaces.

Features a 36" wide roller made of tough durable PVA foam with an anodized aluminum handle and stainless steel, black powder coated T-socket. Stainless steel frame is powder coated and includes all stainless steel hardware. Replacement rollers include end caps.

41064 36" Complete Set-handle & roller \$76.99 ea.

41065 Replacement Roller only 43.99 ea.



Pennant Streamers

Play anywhere!

String across the gym or outdoors to make a quick and easy net! Streamers are 100' long with 18" long plastic pennants.

42070 \$9.99 ea.

Center Straps

Fine quality 2 1/4" nylon webbing.

Adjustable with snap hook.

Weather resistant hardware.

41011 \$9.99 ea.



Gamma® Ballhopper® Risetete™ Plus 55

Holds up to 55 balls.

Extra capacity Risetete basket features Diamond Clad powder coating and reinforced welds for extended life. Handles quickly convert from pick-up position into a stand, placing balls at your fingertips.

41137 \$29.99 ea.

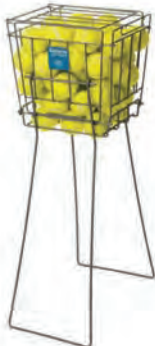

Tennis Post Reel

Fits most existing posts.

Heavy duty steel construction with easily detachable handle.

41034 \$23.99 ea.



RAQUET BALL

Racquetball Racquet

Oversized head for a larger hitting area!

Constructed with a sturdy anodized aluminum frame, braided nylon strings and leather grip.

56007 20.75" L \$17.99 ea.



Wilson® Championship™ Racquetballs

Ideal for all levels of play.

Engineered from a unique rubber compound that provides a consistent bounce. Three balls per can.

56003 \$5.99 cn.



Great Specs®

Superior quality safety goggles!

Constructed from shatterproof polycarbonate with anti fog coating. Ventilated design with an elastic strap that adjusts to fit all sizes.

56017 \$7.99 ea.



FUNCTIONAL TRAINING

SPORTS HEALTH 1.5" Black Poly Plus Battle Rope

This rope won't deteriorate, shed, and can be used in outdoor as well as indoor applications.

This rope is constructed of polypropylene and polyester. It has 2 polyboot ends attached to make it resistant to fraying and very durable. The rope is 1.5" diameter.

- 16554 10'L x 1.5"..... \$67.99 **SALE \$59.97 ea.**
- X16555 15'L x 1.5"..... 89.99 **SALE 78.97 ea.**
- X16556 20'L x 1.5"..... 105.99 **SALE 94.97 ea.**
- X16557 30'L x 1.5"..... 134.99 **SALE 123.97 ea.**
- X16558 50'L x 1.5"..... 159.99 **SALE 149.97 ea.**



VULCAN Fat Grip Black Poly Plus Battling Rope

Wider rope to challenge grip strength!

Constructed of polypropylene and polyester with 2 polyboot ends attached to make it resistant to fraying and very durable.

This rope won't deteriorate, shed, and can be used in outdoor as well as indoor applications. The rope is 2" diameter.

- X16548 20'L x 2"..... \$104.95 ea.
- X16549 30'L x 2"..... 133.99 ea.
- X16550 50'L x 2"..... 159.99 ea.



Training Rope Packs

Create multi-user stations for effective workouts!

Choose a 2 rope or 4 rope pack with poster and anchor station. Weight plates for additional ballast on anchor station not included.

Description	2 Pack	SALE	4 Pack	SALE
SPORTS HEALTH Rope: 15'L x 1.5"	X16559	\$339.97	X16560	\$499.97
SPORTS HEALTH Rope: 30'L x 1.5"	X16852	409.97	X16856	709.97
SPORTS HEALTH Rope: 50'L x 1.5"	X16561	469.97.	X16562	739.97



30' or 50' Sleeved Battle Ropes

Durable nylon sleeve prevents rope fraying.

Sleeve protects rope from fraying while the clamps secure grips in place and prevent excessive wear on the capped ends. Aluminum handles cover the vinyl capped ends for additional protection and user comfort.

- 16851 30'L x 1.5" diameter, weighs 20 lbs..... \$164.99 ea.
- 16850 50'L x 1.5" diameter, weighs 30 lbs..... \$209.99 ea.



The Beast™ Slastix® Battle Rope

Incorporates every major muscle group throughout each exercise.

Unlike traditional ropes, which only allow a single plane of force, Battle Ropes incorporate Slastix® technology, with heavy resistance that elicits muscle contractions throughout the entire body up to three training planes simultaneously. Ropes have nylon wrist straps and are encased in a protective nylon sheath.

- The Beast™**
- X53465 20'L; 47 lbs..... \$143.99 ea.
- X53466 20'L; 77 lbs..... 194.99 ea.
- X53927 20'L; 105 lbs..... 234.99 ea.
- X53928 20'L; 150 lbs..... 265.99 ea.
- Son of the Beast™**
- X53929 10'L; 47 lbs..... \$153.99 pr.
- X53930 10'L; 77 lbs..... 204.99 pr.
- X53931 10'L; 105 lbs..... 245.99 pr.
- X53932 10'L; 150 lbs..... 276.99 pr.



10-Station Battle Rope Anchor

Anchors up to 10 battle ropes for the ultimate group training experience!

Weight loaded anchoring system features 10 securely welded D-rings. Commercial quality, powder coated, stainless steel frame. Easy to transport. Works with Olympic style weights (not included). 28"W x 25"H.

- X54333 \$266.99 ea.



Training Rope Anchor Station

Accommodates up to 12 ropes!

Made from steel with powder coat finish and rubber base to keep unit firmly in place. Add up to 4- 45 lb.

Olympic weight plates for additional ballast. Measures 23.5"W x 23.5"D x 6.5"H. Weighs 32 lbs. Weight plates and ropes sold separately.

- X53933 \$199.99 ea.



Rope Anchor

Better workouts without rope shifting or fraying! Steel construction. Includes fastening hardware.

- X53467 Measures 13"L x 2.5" W.. \$29.99 ea.



Rope Hanger

Keep ropes neat, organized and off the floor. Sturdy steel rope storage mounts to the wall for easy coiling. Mounting hardware included.

- 16240 \$39.99 ea.

RESISTANCE TRAINING

SPORTS HEALTH Resistance Tubing

Cost effective workout method for your whole class! Sturdy tubing with foam covered plastic handles and web strapping for comfort and excellent grip. A variety of resistance levels to meet the needs of your classes. Color coded for easy identification. 48" long. The 6 Pack contains 1- Extra Light, 2- Light, 2- Medium and 1- Heavy tube.

- 53123 Extra Light-Yellow \$5.99 **SALE \$4.87 ea.**
- 53124 Light-Green 6.99 **SALE 5.67 ea.**
- 53125 Medium-Red 7.99 **SALE 6.07 ea.**
- 53126 Heavy-Blue 8.99 **SALE 6.67 ea.**
- 53164 Extra Heavy-Black 9.99 **SALE 7.47 ea.**
- 66594 Sports Health 6 Tube Pack ... 44.99 **SALE 34.97 pk.**
- 21137 HotSpots® Resistance Tubing 44.99 set

Class Packs

- 66160 Sports Health 36-Tube Pack; 9L, 18M, 9H - 2 Tubing posters and 12 Tubing Hotspots \$358.99 **SALE \$299.97 pk.**
- 66162 Sports Health 50-Tube Pack; 12L, 26M, 12H - 2 Tubing posters and 12 Tubing Hotspots 466.99 **SALE 385.97 pk.**



Smart Guard™ Sleeved Tubing

Sheath protects tubing from damage, UV light and drying out. Rubber dipped tubing encased in nylon sheathing with plastic handles and reinforced web straps. 4' long.

- 16864 Light- Lime Green \$17.95 ea.
- 16865 Medium- Red 18.95 ea.
- 16866 Heavy- Dark Blue 19.95 ea.
- 16867 Extra Heavy- Black 20.95 ea.
- 16868 Tubing 4 Pack- one of each resistance 71.99 pk.



ZONE Multi-Use Wall Rack

Organize by size! This convenient rack/holder will allow you to "untangle" the mess and hang tubing out of the way by size and type. Steel rack is 2"W x 24"L. Five 12" pegs will hold 100 tubes. Mounting hardware included.

- 36172 \$41.99 **SALE \$34.97 ea.**



CanDo® Latex Free Tubing Pack

Cut your own tubes to fit your needs! Pack includes 100' of latex free tubing and 25 pairs of easy to attach CanDo® HoldRite Handles. Enough tubing for up to 25 sets with 4' tubes or cut them shorter for younger users.

- 52833 Light Resistance Pack \$214.99 pk.
- 52834 Medium Resistance Pack 224.99 pk.
- 52835 Heavy Resistance Pack 229.99 pk.
- 52836 Extra Heavy Resistance Pack 234.99 pk.



Tube Tree

Holds over 75 tubes. Made of strong 1.75" dia. plastic tubing, assembles in minutes. Measures 20"L x 20"W x 64"H. X36017 \$49.99 ea.

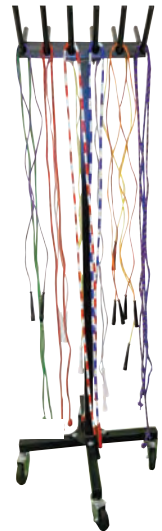

Steel Tubing Cart

Stores up to 100 tubes! Constructed of powder coated steel with rubber casters. Holds jump ropes too! Measures 26"L x 19"W x 65"H. X15893 \$129.99 ea.

RESISTANCE TRAINING



SPORTS HEALTH Ultra Toner

Ideal for 1 or 2 arm exercises.

- Isolate muscles for a powerful workout. Cushioned handles for comfort.
- | | | |
|------------------------------------------|--------|-----------------|
| 16870 Light- Red | \$9.99 | SALE \$6.97 ea. |
| 16871 Medium- Yellow | 10.59 | SALE 7.37 ea. |
| 16872 Heavy- Orange | 10.99 | SALE 7.97 ea. |
| 16873 3 UT Pack- one of each toner | 31.50 | SALE 19.97 ea. |
| 16874 6 UT Pack- two of each toner | 63.00 | SALE 37.97 ea. |

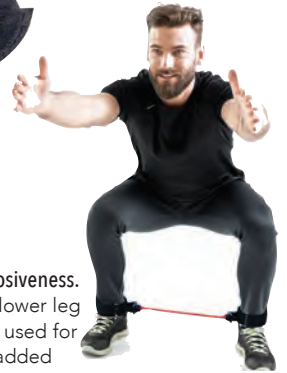

SPORTS HEALTH Leg Toner

Ideal for increasing balance and first step explosiveness. Build lateral movement speed, strengthen lower leg muscles and improve balance. Can also be used for lower arms as well. Nylon straps are well padded with adjustable hook and loop closure.

- | | | |
|------------------------------------------|---------|------------------|
| 16568 Light- Red | \$14.99 | SALE \$12.57 ea. |
| 16875 Medium- Yellow | 12.97 | SALE 12.97 ea. |
| 16876 Heavy- Orange | 17.99 | SALE 13.47 ea. |
| 16877 3 LT Pack- one of each toner | 49.90 | SALE 38.97 pk. |



NEW

TheraBand® Exercise Tubing

Makes measuring progress and achieving goals for fitness or therapy easy. Ideal for upper and lower body exercise, rehabilitation, and conditioning. Portable and easy to use. Resistance is equivalent to noted weight when stretched 100%.

- | | | | |
|-----------------------------------------|-------------|--------------------------------------------------|-------------|
| SH61074 Yellow 25 ft., Thin 3 lbs. ... | \$14.99 ea. | SH61077 Blue 25 ft., X-Heavy 6 lbs. | \$20.99 ea. |
| SH61012 Yellow 100 ft., Thin 3 lbs. ... | 59.99 ea. | SH61026 Blue 100 ft., X-Heavy 6 lbs. | 75.99 ea. |
| SH61075 Red 25 ft., Medium 4 lbs. ... | 17.99 ea. | SH61078 Black 25 ft., Special Heavy 7 lbs. | 22.99 ea. |
| SH61018 Red 100 ft., Medium 4 lbs. ... | 60.99 ea. | SH61027 Black 100 ft., Special Heavy 7 lbs. | 86.99 ea. |
| SH61076 Green 25 ft., Heavy 5 lbs. ... | 18.99 ea. | SH61029 Silver 25 ft., Super Heavy 10 lbs. | 26.99 ea. |
| SH61025 Green 100 ft., Heavy 5 lbs. ... | 66.99 ea. | SH61028 Silver 100 ft., Super Heavy 10 lbs. ... | 101.99 ea. |



CANXDO Exercise Tubing

Bulk tubing that can easily be cut to desired lengths!

Cut to lengths for leg and arm exercises or make smaller cuts to create loops for wrist, foot and ankle exercises. Available in a 100 foot dispenser.

- | | |
|-------------------------------|-------------|
| 52124 Light-Red | \$42.99 ea. |
| 52125 Medium-Green | 44.99 ea. |
| 52126 Heavy-Blue | 49.99 ea. |
| 52127 Extra Heavy-Black | 54.99 ea. |

NEW

TheraBand® 12" Sport Handle

Allows for two hands to grasp for a variety resistance exercises.

Three attachment points. Comes with 2 D ring connectors for easy change of bands or tubing. 12" long.

- | | |
|---------------|-------------|
| SH61650 | \$15.99 ea. |
|---------------|-------------|



CANXDO HoldRite Handles

Rigid handles provide better grip.

The self-locking "adjuster" holds tubing in place during the most strenuous exercises. Use self-locking "adjuster" to increase or decrease resistance by adjusting length of tubing. Full plastic handle.

- | | |
|-------------|------------|
| 16948 | \$7.39 pr. |
|-------------|------------|



Web Slide® Exercise Tube Rail System

Full body training, conditioning and rehab station!

This multi-level exercise system provides an effective full-body resistance workout. It's ideal for fitness, sports training, and rehabilitation facilities. Uses no floor space! Easily attaches to any wall stud. Comes with 16 POWRFit tubes (4 light, 8 medium, 4 heavy) which can be placed on the rail at 15 vertical levels – 5 anchor points per rail – and storage rack (hold up to 16 pcs of equipment). Includes: 3 – 28"L x 6"W wall rails, 24" x 3"H x 2"D wall mounted storage rack, 16 resistance tubes, 12 rubber saddle anchor straps, and 2"W x 3"L instructional exercise chart. (Some equipment shown not included).

- | | |
|------------------------------------------------|--------------|
| X53272 Web Slide® System | \$454.99 set |
| X53271 Single Wall Mount Rail 28"L x 6"W | 99.99 ea. |



RESISTANCE TRAINING



NEW

SPORTS HEALTH Fitness Band Loops

One piece band is perfect for arms and legs. Their light weight, durability and ease of use make fitness loops ideal for sculpting glutes and legs, stretching, and rehabilitation. 12"L x 2"W.

- 17360 X-Light - Green \$2.99 ea.
- 17361 Light - Blue 3.25 ea.
- 17362 Medium - Yellow 3.50 ea.
- 17363 Heavy - Red 3.75 ea.
- 17364 X-Heavy - Black 3.99 ea.

Fitness Band Loop Packs

- 66802 Light Blue - 12 Light Bands \$33.99 pk.
- 66803 Yellow - 12 Medium Bands 37.99 pk.
- 66804 Red - 12 Heavy Bands 39.99 pk.
- 66805 Essential - 4 Light, 4 Medium & 4 Heavy Bands 38.99 pk.
- 66806 Total - 20 (4 ea.) X-Light, Light, Medium, Heavy, X-Heavy 59.99 pk.



GANXDO Exercise Loops

For lower, upper and full body exercises. Made from high quality latex pre-formed into loop. Loops are 3" wide and lengths represent loop when flat. Available in 15" and 30" lengths.

- | | |
|------------------------------------|------------------------------------|
| 15" Loop | 30" Loop |
| 16878 Light- Red \$4.39 ea. | 16881 Light- Red \$5.29 ea. |
| 16879 Medium- Green 4.99 ea. | 16882 Medium- Green 5.79 ea. |
| 16880 Heavy- Blue 5.69 ea. | 16883 Heavy- Blue 6.49 ea. |

Loop Packs

- Each pack consists of one loop of each resistance.
- 16884 15" Loop Pack \$14.99 pk.
 - 16885 30" Loop Pack 16.99 pk.
 - 16886 Combo pack- 3 each 15" & 30" Loops 31.99 pk.



NEW

TheraBand® Resistance Band Loops

An effective and efficient way to strengthen muscles. Three inch wide continuous loop elastic bands are an effective, convenient way to improve strength & flexibility in glutes, knees and hips. Pounds indicated are at 100% stretch. 12"L x 3"W.

- SH62349 Yellow, Thin 3 lbs. \$6.99 ea.
- SH62350 Red, Medium 3.7 lbs. 7.99 ea.
- SH62351 Green, Heavy 4.6 lbs. 9.49 ea.
- SH62352 Blue, X-Heavy 5.8 lbs. 10.49 ea.

SPORTS HEALTH Sports Health Fitness Mega Bands

Create a full body workout without weights! Resistance band loops are an ideal way to build strength, tone muscle and rehab injuries without the hassle of heavy metal free-weights. Comes in a wide variety of resistance levels. 41" long and 3/16" thick.

- 17231 Yellow 5-15lbs, .25"W. \$9.99 ea.
- 17232 Red 15-25lbs, .5"W. 12.99 ea.
- 17233 Green 25-50lbs, .8"W. 15.99 ea.
- 17234 Black 35-70lbs, 1.25"W. 19.99 ea.
- 17235 Lime Green 50-125lbs, 1.75"W. 24.99 ea.
- 17236 Blue 65-175lbs, 2.5"W. 28.99 ea.
- 17237 Orange 85-230lbs, 3.25"W. 35.99 ea.
- 17238 Grey 120-300lbs, 4"W. 39.99 ea.

Fitness Mega Bands Packs

- 54292 Toning Pack (2 ea. Yellow, red, green, black) **SALE \$97.97 pk**
- 54293 Muscle Build Pack (2 ea. Lime, blue, orange, grey) **SALE 219.97 pk**
- 54294 Complete Pack (16 Total - 2 of each color) **SALE 299.97 pk**



RESISTANCE TRAINING



NEW

TheraBand® Resistance Band Roll

Enhance athletic performance and easily measure fitness progress.

The resistance bands are easy-to-use, convenient, portable, and are an effective alternative to free weights and weight machines. Pounds indicated are at 100% stretch. 5.5" wide.

SH61083 Yellow 6 yds., Thin 3 lb.....	\$14.49 ea.	SH61009 Blue 50 yds., X-Heavy 6 lb.....	\$121.99 ea.
SH61003 Yellow 50 yds., Thin 3 lb.....	93.99 ea.	SH61087 Black 6 yds., Special Heavy 7 lb.....	19.99 ea.
SH61084 Red 6 yds., Medium 4 lb.....	16.99 ea.	SH61010 Black 50 yds., Special Heavy 7 lb.....	131.99 ea.
SH61007 Red 50 yds., Medium 4 lb.....	95.99 ea.	SH61088 Silver 6 yds., Super Heavy 10 lb.....	39.99 ea.
SH61085 Green 6 yds., Heavy 5 lb.....	17.99 ea.	SH61011 Silver 50 yds., Super Heavy 10 lb.....	169.99 ea.
SH61008 Green 50 yds., Heavy 5 lb.....	105.99 ea.	SH61065 Gold 6 yds., Maximum 14 lb.....	41.99 ea.
SH61086 Blue 6 yds., X-Heavy 6 lb.....	17.99 ea.	SH61066 Gold 50 yds., Maximum 14 lb.....	239.99 ea.



LATEX FREE!

CAN DO® Exercise Bands

Increase grip strength and get a total body workout! Bands are 6" wide and available in 4 different strength levels. Cut to fit the needs of your classes.

Latex Free	6 Yards	50 Yards
Red-Light	52260 \$10.99 ea.	52264 \$66.99 ea.
Green-Medium	52261 11.99 ea.	52265 72.99 ea.
Blue-Heavy	52262 12.99 ea.	52266 79.99 ea.
Black-Xtra-Heavy	52263 13.99 ea.	52267 89.99 ea.



GoFit® Power Flat Bands

Includes 3 bands and a training manual.

Versatile and effective resistance training to tone and shape the entire body. Choice of latex or latex-free bands. Each pack includes a light, medium and heavy resistance band. Bands measure 4'L x 6"W.

17151 Latex Band Kit.....	\$14.99 kit
17152 Latex-Free Band Kit.....	19.99 kit



MORE GYMSTICKS ONLINE

GymStick™

A total body workout!

The resistance levels are increased simply by wrapping the tubing around the body bar. Made of a 51.8" fiberglass body bar with soft, foam hand grips and 2 resistance tubes with durable fabric loops at each end. Includes nylon carry bag, workout poster and 60 minute DVD with 3 workouts.

53460 Light- Green: Resistance Range 2 - 22 lb..	\$79.99 ea.
53461 Medium- Blue: Resistance Range 2 - 33 lb.	79.99 ea.
53462 Strong- Black: Resistance Range 2 - 44 lb...	79.99 ea.

NEW

TheraBand® CLX Consecutive Loops

Combines versatility, evidence, speed, and inspiration into one pocket-sized product.

This patented exercise tool links a continuous and connected series of resistive loops, creating an ultra-portable, intuitive tool that can quickly be adjusted to perform a seemingly endless array of exercises. Provides multiple unique grip options, enabling open, closed and no-hand grip exercises. Pounds indicated are at 100% stretch.



Single Band, 5 feet

SH1003215 Yellow - Thin 3 lbs.....	\$10.49 ea.
SH1003216 Red - Medium 4 lbs.....	9.99 ea.
SH1003217 Green - Heavy 5 lbs.....	10.49 ea.
SH1003218 Blue - X-Heavy 6 lbs.....	11.49 ea.
SH1003219 Black - Special Heavy 7 lbs.....	14.49 ea.
SH1003220 Silver - Super Heavy 10 lbs.....	14.49 ea.
SH1003221 Gold - Maximum 14 lbs.....	15.99 ea.

Bulk Box, 25 yards

SH1003337 Yellow - Thin 3 lbs.....	\$131.99 ea.
SH1003338 Red - Medium 4 lbs.....	141.99 ea.
SH1003339 Green - Heavy 5 lbs.....	154.99 ea.
SH1003340 Blue - X-Heavy 6 lbs.....	174.99 ea.
SH1003341 Black - Special Heavy 7 lbs.....	204.99 ea.
SH1003342 Silver - Super Heavy 10 lbs.....	229.99 ea.
SH1003343 Gold - Maximum 14 lbs.....	264.99 ea.



RESISTANCE TRAINING



SPORTS HEALTH Versatile Trainer

Total body workout!

Covered tubing provides resistance against forward motion of the arms and legs. Improves first steps and take off power. Partner stands behind to anchor or can also slowly jog for running resistance. Padded adjustable nylon straps attach to legs and arms. Includes carry bag.

16573 \$48.99 ea. **SALE \$39.97 ea.**



SPORTS HEALTH Overspeed Trainer

Build explosive leg power!

Set includes two web strap 48" long belts with neoprene padding, a 7' long covered stretch strap and carry bag.

54204 \$39.99 **SALE \$29.97 ea.**



QUICKLY AND EASILY ANCHORS TO FOOT

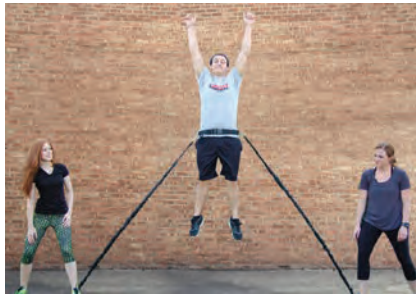

SPORTS HEALTH High Jump Trainer

A simple way to perform dynamic plyometric training.

Resistance increases proportionately to the rate of acceleration of each jump. Anchor the cord ends and begin. Includes two 60" covered latex tubes, 2" wide hook and loop closure 42" long adjustable belt, carry bag and instructions.

16567 \$36.99 ea. **SALE \$29.97 ea.**



SPORTS HEALTH Solo Over Speed Trainer

An ideal tool for training without a partner.

Helps athletes train to maximize strength, speed, and vertical jump. Train with a partner or anchor to a sturdy object with the strong nylon strap. 10' long cloth covered latex tube. Adjustable harness.

17262 \$34.99 ea.



NEW

SKLZ HOPZ 2.0 Vertical Trainer

Build explosive leg power and strengthen lower body muscles.

The vertical trainer enables you to target specific muscles and is an excellent tool for engaging quads, calves, hamstrings and more. Also perfect for anyone training for football, basketball, or volleyball. Features multiple resistance levels which can be adjusted quickly with the patented padded belt, and ankle straps. Also includes durable cables and built-in shoe harnesses.

54358 \$62.99 ea.



SKLZ Recoil 360°

Alternate between resistance and assistance!

Build strength and conditioning for sprinting, leaping, shuffling or change of direction. Work with a partner or attach the leash to a stationary object. Includes an adjustable belt with free motion ring that allows movement in any direction, an 8' flexi-cord that safely stretches up to 20', a safety handle and storage bag.

53913 \$44.99 ea.

MEDICINE BALLS



SPORTS HEALTH Rubber Medicine Balls

Designed for vigorous workout routines!

One piece sturdy rubber construction has a textured surface for enhanced grip. Shape and bounce are maintained via a rubber valve.

X29559 Orange 4 lbs	\$24.99	SALE \$17.97 ea.
X29560 Blue 6 lbs.	34.99	SALE 24.97 ea.
X29561 Red 8 lbs.	41.99	SALE 28.97 ea.
X29562 Black 10 lbs.	44.99	SALE 31.97 ea.
X29563 Purple 12 lbs.	51.99	SALE 39.97 ea.

SPORTS HEALTH Medicine Ball Combo Pack

Includes one each of: 4 lbs., 6 lbs., 8 lbs., 10 lbs., & 12 lbs.

X29569 Set of 5	\$159.85	SALE \$139.97 set
-----------------	----------	--------------------------



ELEMENT FITNESS Commercial Medicine Balls

Great cross trainer for any sport or workout!

Durable PVC rubber construction with textured surface for maximum grip and control. Ideal ball to combine strength training, cardio, flexibility and dynamic muscle training.

X16890 4 lbs. 6.5" diameter	\$25.50 ea.
X16891 6 lbs. 9" diameter	31.50 ea.
X16892 8 lbs. 9" diameter	36.99 ea.
X16893 10 lbs. 9" diameter	43.99 ea.
X16894 12 lbs. 9" diameter	55.99 ea.
X16900 Light Weight 6 Ball Pack- 2 of each: 4 lb., 6 lb. & 8 lb.	174.99 pk.
X16901 Medium Weight 6 Ball Pack- 2 of each: 10 lb., 12 lb. & 16 lb.	329.99 pk.
X16902 Heavy Weight 6 Ball Pack- 2 of each: 20 lb., 25 lb. & 30 lb.	699.99 pk.

ELEMENT FITNESS Combo Ball Packs with Rack

A combination of our best balls!

Both racks are commercial quality, constructed of steel with a corner design for smaller imprint.

10 Ball Combo Pack

Includes: One of each Commercial Balls: 4 lb., 6 lb., 8 lb., 10 lb. & 12 lb. and 10 lb., 15 lb., 20., 25 lb. & 30 lb. Pro Slam balls and 10 Ball Rack.

X16911 1	\$569.99 pk.
----------	--------------



15 Ball Combo Pack

Includes: One of each Commercial Balls: 4 lb., 6 lb., 8 lb., 10 lb., 12 lb., 16 lb., 20 lb. & 30 lb. and 6 lb., 8 lb., 10 lb., 12 lb., 15 lb., 20. & 25 lb. Pro Slam balls and 15 Ball Rack.

16912 15 Ball Combo Pack	\$949.99 pk.
16913 10 Med Ball Rack only	199.99 ea.
16914 15 Med Ball Rack only	283.99 ea.



X-TREME MONKEY Pro Slam Balls

Premium commercial balls made to withstand slam after slam!

Textured, thick rubber designed for excellent grip. Features a dead bounce and won't roll away.



Lbs.	Dia.	Item	Each
4	9"	X16903	\$19.99
6	9"	X16904	25.99
8	9"	X16905	29.99
10	9"	X53496	27.99
12	9"	X16906	29.99
15	9"	X53497	32.50

Lbs.	Dia.	Item	Each
20	9"	X53498	\$40.99
25	9"	X53499	49.99
30	9"	X53956	60.99
35	9"	X16907	72.99
40	9"	X53957	80.99
50	9"	X53959	82.50

X-TREME MONKEY Ball Packs

X16908 Low Weight 8 Ball Pack- 2 of each: 4 lb., 6 lb., 8 lb. & 10 lb.	\$194.99 pk.
X16909 Medium Weight 4 Ball Pack- 1 of each: 10 lb., 12 lb., 15 lb. & 20 lb.	124.99 pk.
X16910 Heavy Weight 4 Ball Pack- 1 of each: 25 lb., 30 lb., 35 lb. & 40 lb.	269.99 pk.

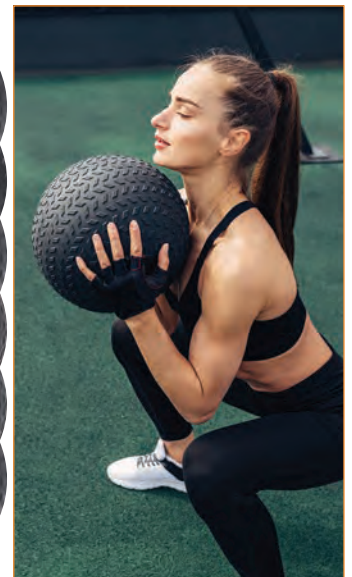

MEDICINE BALLS

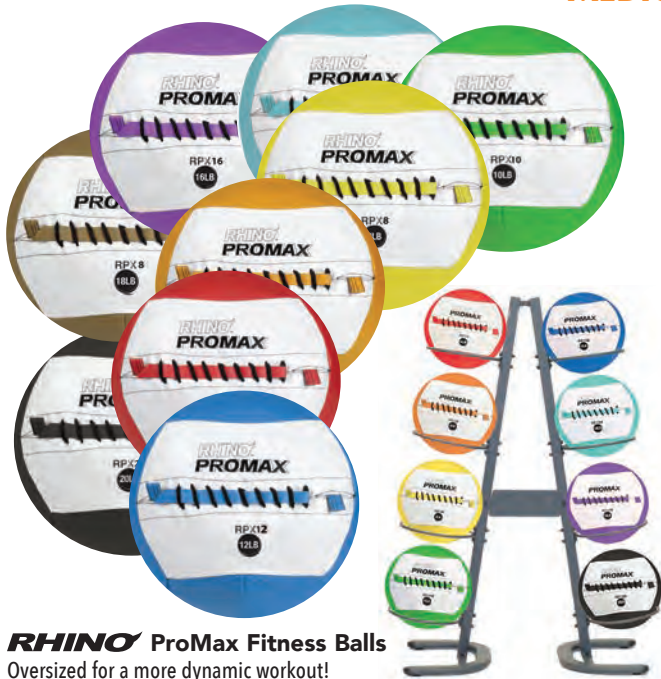

RHINO ProMax Fitness Balls

Oversized for a more dynamic workout!
Constructed with a soft outer layer for a great feel yet strong enough to withstand high velocity impact. Designed to maintain a balanced weight and remain stable.

Color	Lbs.	Dia.	Item	Each	Color	Lbs.	Dia.	Item	Each
Red	4	14"	X53315	\$27.99	LT. BLUE	14	14"	X53320	\$41.99
Orange	6	14"	X53316	32.99	PURPLE	16	14"	X53321	44.99
Yellow	8	14"	X53317	33.99	BROWN	18	14"	X53322	47.99
Green	10	14"	X53318	34.99	BLACK	20	14"	X53323	52.99
BLUE	12	14"	X53319	35.99 ea.					

ProMax Medicine Ball Class Pack

Rack is constructed of steel and has a U shape base for stability. Holds 8 oversized medicine balls. Class Pack includes one of each 4, 6, 8, 10, 12, 14, 16, and 20 lb. medicine balls and medicine ball rack.
T66544 Pack; 8 Medicine Balls and Rack-ships by truck \$499.97 **SALE \$499.97 pk.**
X54194 Medicine Ball Rack only..... 219.99 **SALE 209.97 ea.**



XTREME MONKEY Wall Balls

Excellent quality at a great price!
Designed to allow the athlete to increase the weight without changing their movement. These med balls have a more "solid" feel compared to other balls on the market. Balanced, easy to grip and can take a tough workout. Cover is constructed of a doubled stitch PVC for durability. Not designed for slamming exercises. 14" diameter.
16246 8 lbs..... \$59.99 ea.
16247 10 lbs..... 63.99 ea.
16248 14 lbs..... 72.99 ea.
16249 20 lbs..... 89.99 ea.

CLASSIC COVER



RHINO Leather Medicine Balls
Genuine leather covers!

These hand sewn heavy duty leather covered balls with weighted filler will help you continue this basic and simple workout.

Color	Lbs.	Dia.	Item	Each
Red	4-5	9.4"	X25024	\$17.99
Yellow	6-7	24.5"	X25025	19.99
Blue	10	24.5"	X25026	22.99
Orange	11	25"	X25027	26.99
Green	14	26.3"	X25028	29.99

Rhino Leather Medicine Ball Pack

5 ball Med Ball Pack Includes one of each: 4-5, 6-7, 10, 11 and 14 lb. balls. Optional Ball rack (#25114) available on page 212.
X16244 \$120.99 pk. **SALE \$109.67 pk.**

INSTABILITY TRAINING



RHINO Gel Filled Medicine Balls

Perfect for CrossFit training!
Built to withstand tough workouts- roto molded vinyl shells absorb impact and retain shape quickly. Will not split or leak. Textured grip for easy catching drills.

Color	Lbs.	Dia.	Item	Each
Blue	4	6"	X52917	\$13.99
Green	7	7"	X52918	17.99
Purple	11	8.5"	X52919	27.99
Orange	15	10"	X52920	34.99

VIDEO ONLINE

MEDICINE BALLS



NEW

TheraBand® Soft Weight Set

A great alternative to traditional dumbbells or other weighted workout balls. Designed for strengthening, plyometrics, balance training, and mobilization of the user's hands or wrists. They can also be used with one or two hands to promote functional grip strength development. Soft exterior shell. 4.5" diameter each. Includes 6 balls: 1.1, 2.2, 3.3, 4.4, 5.5, and 6.6 lbs.

SH61284 6-Ball Set..... **\$129.99 set**



NEW

Cando® WaTE Ball

Small and flexible color-coded balls that measure 5" in diameter.

Hand held WaTe balls offer all the benefits of traditional weight training without using hard-to-hold metal dumbbells. Also excellent for rehabilitation purposes and physical therapy.

- SH62215 Tan, 1.1 lbs..... **\$10.35 ea.**
- SH62216 Yellow, 2.2 lbs..... **11.95 ea.**
- SH62217 Red, 3.3 lbs..... **13.35 ea.**
- SH62218 Green, 4.4 lbs..... **14.90 ea.**
- SH62219 Blue, 5.5 lbs..... **16.30 ea.**
- SH62220 Black, 6.6 lbs..... **17.85 ea.**
- SH62222 6-Ball Pack - 1.1, 2.2, 3.3, 4.4, 5.5 & 6.6 lbs. **83.60 pk.**
- SH62223 WaTE Ball Rack (Balls not included) **66.99 ea.**



8
Printed Exercises
for Easy Reference



NEW

Smart Medicine Balls with Rack

Eight exercises printed on each ball makes workouts easy.

The weighted center forces the user to use different muscle groups to throw, bounce or twist with the ball. Textured surface for a reliable grip and made of sturdy rubber. Rack features space saving wall-mount design and heavy duty steel construction. Measures 9"W x 11"D x 43"H. Includes 4 balls: 4, 6, 8 and 10 lbs.

29570 4-Ball Set with Rack..... **\$348.99 pk.**
29571 Wall Rack (only)..... **159.00 ea.**



NEW

Cando® Dual Hand Medicine Balls

Soft grip handles enable a wide range of movements.

These medicine balls are ideal for training, rotational movements and strength training. They are ideal for core and torso exercises.

- SH62209 Yellow, 6lbs..... **\$60.99 ea.**
- SH62210 Red, 12 lbs..... **71.99 ea.**
- SH62211 Green, 18 lbs..... **76.99 ea.**
- SH62212 Blue, 24 lbs..... **91.99 ea.**
- SH62213 Black, 30 lbs..... **106.99 ea.**
- SH62214 5-Ball Pack - 6, 12, 18, 24 & 30 lbs..... **349.99 pk.**



X25130



X53174



X25114



X25115



X25128

Medicine Ball Racks

Space saving racks!

Racks feature easy access tilt design, heavy duty steel tube construction and powder coat finish. Upright Rack has swivel casters for transport. Some assembly required on racks. Balls sold separately.

- X25130 12 Ball Rack-Measures 28"L x 44"W x 40"H; weighs 30 lbs..... **\$169.99 ea.**
- X53174 15 Ball Rack- Measures 53"L x 9.5"W x 35"H; weighs 31 lbs. **199.99 ea.**
- X25114 5 Ball Rack- Measures 14"L x 11"W x 52"H **71.99 ea.**
- X25115 10 Ball Rack- Measures 22.5"L x 11"W x 52"H **75.99 ea.**
- X25128 20 Ball Rack- Measures 25"L x 25"W x 56"H **229.99 ea.**

SANDBAGS



XTREME MONKEY Tornado Bag
Great for slamming, chopping and swinging drills!
Fits most standard rubber medicine balls. Made from a thick vinyl with reinforced seams, nylon strapping and a 30" long rope.
16293 \$39.99 ea.

XTREME MONKEY Medicine Ball Rebounder

Vary workouts and intensity!
Extra wide base for stability and weight distribution. Frame is made of heavy duty steel tubing with powder coat finish. Pop pin angle adjustment. Measures 38" L x 38" W x 40" H; weighs 45 lbs. Some assembly required.
X16297 \$249.99 ea.



Surge® Storm Fluid Resistance Trainer
Use Hydro-Inertia™ to improve overall health & performance!
Choose the full-size Storm, or the compact Riptide – utilize water to create an unstable/unpredictable resistance workout and challenge muscles. Over 50 innovative movement patterns. Vertical, horizontal, and exterior grip options.
Storm: 9 – 60.5 lbs. (filled). Riptide: 7.5 – 38 lbs. (filled).
54317 Storm Orange 42" L x 8.5" D. \$179.95 ea.
54318 Riptide Green 33.25" L x 8.5" D 109.95 ea.



PRE-FILLED with SAND



SandBells®
Use as a dumbbell, kettlebell, medicine ball and more!
Completely versatile for your workout needs! Thick neoprene is soft and stretchy to the touch, but also durable enough to be pulled, yanked and abused daily. Use for full range of motion exercises for any age group. Sizes range from 2 lb. to 10 lb. with a color coded ring for weight identification. SandBells are pre filled with sand.

Filled Sandbell Packs
Light Mini Pack includes 2 of each: 2 lb, 4 lb, and 6 lb.
X66500 Filled Light Pack \$119.99 pk.
Heavy Mini Pack includes 2 of each: 6 lb, 8 lb, and 10 lb.
X66600 Filled Heavy Pack 174.99 pk.
Mega Pack includes 2- 2 lb., 4- 4 lb., 4- 6 lb., 4- 8 lb., and 2- 10 lb.
X66579 Filled SandBell Mega Pack 348.99 pk.



SoftBell® DumbBell KettleBell Combo Set
Safer at home or in the gym...easier on the body!
This innovative design combines an extremely durable, yet soft, neoprene case with a sand fill to create a versatile and safer alternative to traditional dumbbells & kettlebells. SoftBell® plates are interchangeable to suit a variety of workouts. Sets include: 12 plates (full set includes 24), 1 kettlebell handle, 2 dumbbell handles, 4 short bolts and 5 long bolts (use to add multiple plates).
X66770 Light Combo Set: 4 ea. of 1.5 lb., 3 lb., and 4.5 lb. \$244.99 set
X66771 Heavy Combo Set: 4 ea. of 6 lb., 7.5 lb. and 10 lb. 275.99 set
X66772 Full Combo Set: 4 ea. of 1.5 lb., 3 lb., 4.5 lb., 6 lb., 7.5 lb., and 10 lb. 339.99 set

NEW SandBell® Storage Rack
Ideal for storing weights vertically in tight spaces.
Made of sturdy steel construction, the rack features 6 shelves that can store SandBells®, SoftBells®, and SteelBells®. Dimensions: 57.25" H X 18.75" W X 25" D, 17.6 lbs.
29572 \$99.99 ea.



WEIGHTED VESTS/SANDBAGS

XTREME MONKEY

Adjustable Weight Vest

This commercial weight vest doesn't sag! Weight is evenly distributed throughout the vest for comfort and balance. Made from strong nylon with adjustable Velcro® straps for the perfect fit. Vest includes incremental weights that won't fall free from the pockets.
16282 25 lbs. **\$138.99 ea.**
16283 35 lbs. **143.99 ea.**
16284 45 lbs. **149.99 ea.**
16285 55 lbs. **179.99 ea.**



Body Solid Weighted Vest

Fully adjustable nylon vest has Velcro® straps to fit body. Even weight pockets result in optimal center of gravity without restricting movement. Increase or decrease load with 1 lb. weight rods.
X16920 20 lb. **\$83.99 ea.**
X16921 40 lb. **91.99 ea.**



Ankle/Wrist Weights

One size fits all! Soft neoprene cover with an adjustable Velcro® closure for a friction free, comfortable fit.
X52271 1 lb. each (2 lb. pr) **\$9.99 pr.**
X52272 2.5 lb. each (5 lb. pr) **15.99 pr.**
X52273 5 lb. each (10 lb. pr) **19.99 pr.**



XTREME MONKEY Commercial Sandbags

Ideal for heavy lifts, carries, and core training. Made from heavy duty tactical nylon with multiple handles for a variety of grips. Includes two interior filler bags made from tough PVC with secure closures. Sandbags not designed for slams. Sand not included.
16294 20 lbs. - 32"L x 13" **\$79.99 ea.** **16296** 80 lbs. - 32"L x 13" **\$130.50 ea.**
16295 50 lbs. - 27"L x 10" **99.99 ea.** **16915** 3 Pack: one of each **319.99 pk.**



VULCAN Sand Bag

5 handle positions! Constructed from 1050 denier ballistic nylon with heavy duty parachute grade stitching, button enclosures and zipper. Includes 3 pouches- a 22"L x 8"W medium pouch holding up to 20 lbs. and 2 larger 33"L x 9"W pouches holding up to 40 lbs. each. Peat gravel is recommended filler as it leaves the bag more pliable than traditional sand. Filler not included.
16731 36"L x 12" **\$79.99 ea.**
16916 3 Pack **217.99 pk.**



SKLZ

Super Sandbag
 Durable with secure zippers and multiple handles for a variety of grips. Includes 4 heavy duty vinyl weight bags that hold up to 10 lbs. of sand per bag. Removable weight bags can be used as soft weights separately. Maximum capacity for entire bag is 40 lbs. Sand not included.
53375 **\$53.99 ea.**
16917 3 Pack **143.99pk.**



Elgin Long Strap Cuff Weights

Designed for clinical applications like athletic training and professional fitness. The extra-long Velcro straps (10"-14"L) make it possible for layering cuffs on cuffs for a true progressive resistance exercise program. Non-absorbing Naugahyde material. Works on wrists and ankles.
SH61050 1 lb. **\$16.99 ea.** **SH61267** 4 lbs. **\$20.99 ea.**
SH61052 2 lbs. **17.99 ea.** **SH61055** 5 lbs. **23.99 ea.**
SH61053 2.5 lbs. **17.99 ea.** **SH61056** 7.5 lbs. **33.99 ea.**
SH61054 3 lbs. **19.99 ea.** **SH61057** 10 lbs. **39.99 ea.**

Cuff Weight Mobile Storage Rack

Two-sided rack keeps cuff weights organized and in a central location. Heavy-duty steel construction. Holds up to 500 lbs. Rubber ball-bearing wheels roll smoothly over indoor surfaces. Dimensions: 24"W x 35"D x 48"H, 40 lbs.
SH1007577 **\$319.99 ea**



Kettlebell Rack

Stores up to 12 of the 8" diameter Kettlebells! Made from steel with a powdercoat finish. Rubber lined shelves reduce noise. Easy assembly. Measures 45-1/4"W x 22"L x 30"H. Kettlebells not included.
X53503 **\$269.99 ea.**



NEW

Cando Kettlebell Storage Rack

Durable iron rack securely holds kettlebells for easy access during training. Two-tier shelving. 660 lbs. capacity. Dimensions: 47"W x 32"H x 26"D, 60 lbs.
SH62208 **\$350.00 ea.**



KETTLEBELLS



RHINO 6" Kettlebells

Made from a Latex™ free material with an ABS plastic handle!
Not intended for bouncing or throwing exercises. Deluxe packs include rack X53503, see page 236.

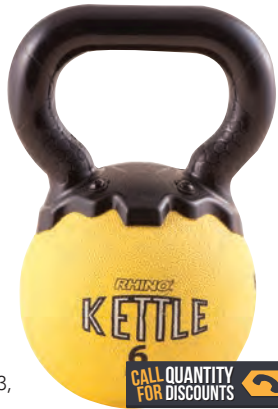

CALL QUANTITY FOR DISCOUNTS

Description	Lbs.	Item	Each
Purple	5	X53506	34.99
Yellow	6	X53507	38.99
Teal	7	X53508	46.99
Green	8	X53509	50.99

Class Packs

X54117 6" Medium 6 Pack- 2 each: 6, 7, & 8 lb. \$ 259.99 pk.
X53534 6" Deluxe Pack- 2 each: 3, 4, 5, 6, 7, & 8 lb. & rack 629.99 pk.



CANIDO Vinyl Kettlebells

Ergonomic grip design.
Vinyl coated Cast iron to reduce noise and protect floors. Deluxe pack includes rack X53503, see page 236. Ships by truck.



Description	Lbs.	Item	Each	Description	Lbs.	Item	Each
Yellow	5	X54233	\$18.39	Black	20	X52813	\$43.99
Red	7.5	X54234	22.39	Silver	25	X52814	52.99
Green	10	X52810	23.99	Gold	30	X52815	59.99
Royal	15	X52811	32.99				

Class Packs

XSH62207 Essential 5 Pack - 1 each: 5, 7.5, 10, 15 & 20 lbs. \$141.00 pk.
X54120 Medium 6 Pack- 2 each: 10, 15, & 20 lb. **202.99 SALE 194.97 pk.**
T54121 Heavy 6 Pack- 2 each: 20, 25, & 30 lb. **359.99 SALE 302.97 pk.**
T54122 Deluxe Pack- 2 each: 10, 15, 20, 25, & 30 lb. & rack **519.97 SALE 519.97 pk.**



Body-Solid Premium Kettlebell

Featuring a chrome handle and a dipped rubber base.

Chrome handles easily slide in your hands. Handles on the heavier weights are large enough to accommodate both hands. Deluxe packs include rack X53503, see page 236. Ships by truck.



Description	Item	Each	Description	Item	Each
5	X54250	\$11.99	30	X54255	\$65.99
10	X54251	21.99	35	X54256	75.99
15	X54252	32.99	40	X54257	86.99
20	X54253	43.99	45	X54258	97.99
25	X54254	54.99	50	X54259	108.99

Class Packs

X54244 Medium 6 Pack- 2 each: 5, 10 & 15 lb. \$129.99 **SALE \$114.97 pk.**
X54245 Heavy 6 Pack- 2 each: 20, 25 & 30 lb. **309.99 SALE 295.97 pk.**
T54246 Deluxe Med. 10 Pack- 2 each: 5, 10, 15, 20 & 25 lb & Rack **479.99 SALE 459.97 pk.**
T54247 Deluxe Heavy 10 Pack- 2 each: 30, 35, 40, 45 & 50 lb & Rack ... **899.99 SALE 849.97 pk.**



YORK IRON Kettlebells

Made from cast iron!

Perfect for strength training, muscle coordination and aerobic exercise. Mega and deluxe packs include rack X53503, see page 236. Ships by truck.

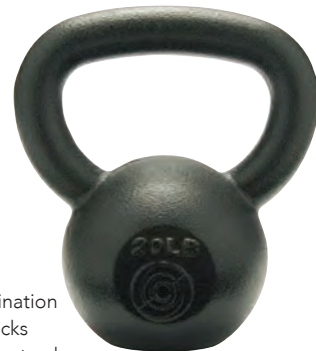

Description	Item	Each	Description	Item	Each
10 lbs.	X52661	\$18.99	25 lbs.	X52663	\$45.99
15 lbs.	X52662	27.99	30 lbs.	X25814	52.99
20 lbs.	X25813	35.99	35 lbs.	X52664	60.99

Class Packs

X54123 Medium Pack - 2 each: 10, 15, & 20 lb. \$169.99 **SALE \$139.97 pk.**
X54124 Heavy Pack - 2 each: 25, 30, & 35 lb. **309.99 SALE 289.97 pk.**
T54125 Deluxe Pack- 2 each: 10, 15, 20, 25, 30 lb. & rack **599.99 SALE 539.97 pk.**
T52670 Mega Pack- 2 each: 10, 15, 20 lb. & 1 each: 25, 30, 35, 40, 45, 50, 60, 70 lb. & rack **SALE 749.97 pk.**

HANDWEIGHTS



PREMIUM NEOPRENE COATING

Neoprene Hex Dumbbells

Thick neoprene coating with hexagon design so they won't roll! Dumbbells and rack sold individually or Class Pack is available. Rack has locking bar, swivel casters and holds up to 500 lbs. Made from powder coated steel and measures 37.5"L x 16"W x 42.25"H. Ships by Truck. Colors many vary.

Description	Lbs.	Item	Each	Description	Lbs.	Item	Each
Pink	1	X52649	\$2.25	Green	6	X52654	\$13.50
Dk. Pink	2	X52650	4.50	Purple	7	X52655	15.75
Lime	3	X52651	6.75	Red	8	X52656	18.00
Lt. Blue	4	X52652	9.00	Black	9	X52657	20.25
DK. BLUE	5	X52653	11.25	GRAY	10	X52658	22.50

T52659 Dumbbell Rack 61 lbs. \$449.99 ea.

Neoprene Hex Dumbbell Class Pack

Includes: 16-1 lb., 12-2 lb., 10-3 lb., 10-4 lb., 9-5 lb., 8-6 lb., 8-7 lb., 8-8 lb., 7-9 lb., 7-10 lb. dumbbells and rack. Total weight 456 lbs.

T52660 \$989.99 pk.



TROY Soft Vinyl Iron Hand Weights

Premium vinyl dumbbells with contoured handles.

Dumbbells and Stackable Rack are sold individually. The Stackable Rack is constructed of heavy gauge steel with a locking mechanism at the top. Aerobic Pack includes the Rack and 43 pairs of assorted weight dumbbells. Casters can be purchased separately to convert rack to a mobile unit. Ships by Truck.

Description	Lbs.	Item	Each	Description	Lbs.	Item	Each
Dk. Pink	1	X52051	\$1.99	Red	6	X52002	\$11.75
Purple	2	X52052	3.99	Dk. Purple	7	X52056	13.75
Green	3	X52053	5.99	Black	8	X52003	15.75
Lt. Purple	4	X52054	7.99	Yellow	9	X52004	17.50
Dk. Blue	5	X52055	9.99	Orange	10	X52057	18.99

T52060 Stackable rack only; casters sold separately \$399.99 ea.

T52061 Aerobic Pack-Includes rack & 43 pairs of weights 1,019.99 pk.

X52067 Casters for Rack set of 4 76.99 set

X52071 Under Rack 102.99 ea.



Cando® Vinyl Coated Dumbbell Packs

Choose between sets with or without wall racks.

Coated weight does not scratch floors. Feels comfortable in the hand. Racks are wall mounted and hold up to 10 dumbbells. Rack dimensions: 3"W x 48"H x 3"D, 23 lbs.

SH62240 10-Dumbbell Pack - 2 each: 1 - 5 lbs \$98.99 pk.

SH62242 20-Dumbbell Pack - 2 each: 1 - 10 lbs 344.99 pk.

SH62241 10 Pack with Wall Rack 259.99 pk.

SH62243 20 Pack with 2 Wall Racks 454.99 pk.

Cando® Dumbbell Floor Rack

Floor rack holds 10 pairs of dumbbells (not included). Dimensions: 20" L x 20"W x 28"H.

SH62245 \$136.99 ea.



ELEMENT Colored Aerobic Hex Dumbbell Set

Color coded for easy identifying & will not chip or peel! Rubber encased dumbbells with contoured chrome knurled handles. Sold as a set: one pair of each weight 2 lbs. through 12 lbs; 2 lb. Indigo, 3 lb. Green, 4 lb. Sky Blue, 5 lb. Royal Blue, 6 lb. Red, 7 lb. Purple, 8 lb. Black, 9 lb. Yellow, 10 lb. Orange, 12 lb. Purple. Available as a pack with rack. Ships by Truck

T17149 Aerobic Hex Dumbbell Set \$442.99 set

T17150 Aerobic Hex Dumbbell Set with Rack 519.99 ea.

X16729 Rack only 115.99 ea.



CALL QUANTITY FOR DISCOUNTS

DUMBBELLS

TROY Solid Hex Dumbbells
Ergonomically designed for comfort and safety. Hammertone finish with knurled handle for secure grip.

Lbs.	Item	Each	Lbs.	Item	Each
3	X53304	\$4.50	30	X52703	\$44.99
5	X52698	7.25	35	X52704	56.99
10	X52699	14.25	40	X52705	62.99
15	X52700	24.99	45	X52706	73.99
20	X52701	31.99	50	X52707	78.99
25	X52702	38.99			



YORK Rubber Hex Dumbbells
Cast iron heads encased in maintenance free rubber. Permanently attached with solid steel, chrome plated, knurled handle.

Lbs.	Item	Each	Lbs.	Item	Each
3	X53305	\$7.99	30	X52677	\$48.99 ea.
5	X52672	10.99	35	X52678	54.99 ea.
10	X52673	16.99	40	X52679	63.99 ea.
15	X52674	24.99	45	X52680	69.99 ea.
20	X52675	33.99	50	X52681	77.99 ea.
25	X52676	39.99			



Dumbbell Station Pack with Rack
Most popular sizes in packs!

Rack is constructed of 11 gauge steel measuring 2" x 3" with powder coat finish and high impact polyethylene cradles to adjust each level to fit your needs. Available in gray only, Ships by Truck.

- TROY Solid Hex Station Packs**
- X53307 Low Weight Pk- 5 ea.- 3, 5 & 10 lb dumbbells & rack \$599.99 pk.
 - T53308 Medium Weight Pk- 5 ea.- 5, 10 & 15 lb dumbbells & rack 699.99 pk.
 - T53309 Heavy Weight Pk- 5 ea.- 20, 25 & 30 lb dumbbells & rack 949.99 pk.
 - X53306 Dumbbell Rack only- measures 70"L x 36"H x 24"D. 419.99 ea.

- YORK Rubber Hex Packs**
- X16608 Low Weight: 2 of each: 3, 5, 10, 15 & 20 lb dumbbells & rack \$562.99 pk.
 - T16609 Medium Weight : 2 of each: 10, 15, 20, 25 & 30 lb dumbbells & rack 673.99 pk.
 - T16610 Heavy Weight: 2 of each: 30, 35, 40, 45 & 50 lb dumbbells & rack 857.99 pk.
 - X53306 Dumbbell Rack only- measures 70"L x 36"H x 24"D. 419.99 ea.



ELEMENT Commercial Hex Dumbbells
Made with virgin rubber- no toxic smell!
Ergonomic knurled handle reduces fatigue and maximizes comfort. Commercial rack holds 13 pair of dumbbells, measures 38"H x 56"W x 34"D.

- 16943 Complete Weight Pack- 2 of each: 5-50 lbs. & Rack: Ships by Truck. \$1,699.99 pk.
- 16944 3 Tier Rack only. 699.99 ea.

Lbs.	Item	Each
3	X16930	\$5.69
5	X16931	9.49
8	X16932	14.99
10	X16933	18.99
12	X16934	25.50
15	X16935	31.99
20	X16936	42.50

Lbs.	Item	Each
25	X16937	\$52.99
30	X16938	63.99
35	X16939	74.99
40	X16940	84.99
45	X16941	94.99
50	X16942	97.99



VULCAN Hex Rubber Dumbbell Sets
Chrome plated with steel handles.
Proprietary handle process eliminates worries of heads separating from dumbbells. Knurled handles measuring 28mm diameter for 5-20 lbs. and 33.5-35mm diameters for 25-100lbs. Steel rack has powder coat finish and will store up to 12 pairs of dumbbells. Rack measures 56"L x 35"H x 18"W; weighs 125 lbs.



Lbs.	Item	Pair
5	X16701	\$24.99
10	X16702	43.99
15	X16703	53.99
20	X16704	69.99
25	X16705	81.99

Lbs.	Item	Pair
30	X16706	\$99.99
35	X16707	129.99
40	X16708	149.99
45	X16709	169.99
50	X16710	189.99

- All sets ship by truck.
- T16711 Low Weight Pack- 2 of each: 5, 10, 15, 20 & 25 lbs. & Rack \$418.99 pk.
 - T16712 Heavy Weight Pack- 2 of each: 30, 35, 40, 45 & 50 lbs. Rack 756.99 pk.
 - T16713 Complete Weight Pack- 2 of each: 5-50lbs & Rack 876.99 pk.
 - T16714 Rack only. 299.00 pk.

WEIGHTS



CALL QUANTITY FOR DISCOUNTS



Pro Style Fixed Straight & Curl Bars

Ideal for group fitness!

The barbell heads are comprised of solid steel inserts fully encased in rubber. The solid steel handle passes through the steel insert and is welded permanently joining the head to the bar. Rubber coating increases durability, protects equipment, enhances appearance, diminishes noise, and is easy to clean. Bar rack is made from bent steel tubing and holds 10 bars. Rack measures 34"W x 33.5"D x 66"H.

Fixed Straight Barbells

Description	Item	Each
20	X16670	\$62.99
30	X16671	89.99
40	X16672	119.99
50	X16673	146.99
60	X16674	174.99

Description	Item	Each
70	X16675	\$199.99
80	X16676	237.99
90	X16677	265.99
100	X16678	289.99
110	X16679	317.99

Fixed Curl Barbells

Description	Item	Each
20	X16680	\$62.99
30	X16681	89.99
40	X16682	119.99
50	X16683	146.99
60	X16684	174.99

Description	Item	Each
70	X16685	\$199.99
80	X16686	237.99
90	X16687	265.99
100	X16688	289.99
110	X16689	317.99

All sets ship by truck.

Sets consist of 10 bars, one of each in each weight available.

- T16658 Fixed Straight Bar Set \$1,749.99 set
- T16659 Fixed Curl Bar Set..... 1,749.99 set
- T16660 Fixed Straight Bar Set with Rack..... 2,049.99 set
- T16661 Fixed Curl Bar Set with Rack..... 2,049.99 set
- T16662 Barbell Rack only..... 389.99 ea.

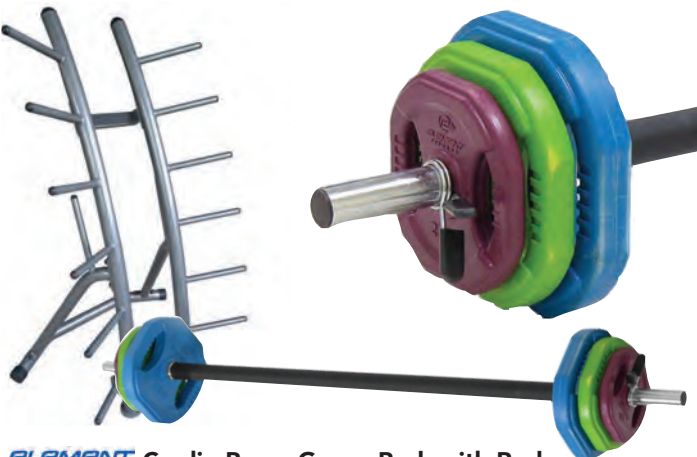

Element Cardio Pump Group Pack with Rack

Perfect for group training!

Rubber plates are easy to adjust with spring collars. Each hollow steel 53" long bar set includes 2- 5kg, 2-2.5kg, 2-1.25kg plates and a pair of spring collars. Racks are made from steel with powder coat finish. 10 Bar Rack measures 54"H x 25"W x 24"D. Ships by truck.

T16313 Cardio Pump 10 Pack \$1,699.99 pk.



NEW

Body-Solid® Pro Dumbbell Pack with 2 Tier Rack

Patent pending SDS system with professional storage rack.

Secure Dumbbell System combines one-piece cast heads with steel inserts, pinned, press fitted, and welded. Compact design makes them shorter and easier to handle. Durable rubber coating prevents damage to floors and equipment. Rack features: Heavy gauge steel, 4-side welded construction, deburred inside/out for user safety, heavy-duty 2" x 3" mainframe has a reversed pitch design that allows easy access. Dimensions: 23 L x 62"W x 32"H.

- T54334 Complete Weight Pack - 2 of each: 5-50 lbs. & Rack \$1,049.99 pk.
- X54296 2-Tier Rack only 274.99 ea.



NEW

Body-Solid® 3-Tier Dumbbell Rack

Body-Solid® Pro Dumbbell Pack with 3 Tier Rack

Patent pending SDS system with professional storage rack.

Secure Dumbbell System combines one-piece cast heads with steel inserts, pinned, press fitted, and welded. Compact design makes them shorter and easier to handle. Durable rubber coating prevents damage to floors and equipment. Rack features: Heavy gauge steel, 4-side welded construction, deburred inside/out for user safety. Dimensions: 40"L x 20"W x 30" H.

- T54335 Complete Weight Pack - 2 of each: 5-50 lbs. & Rack \$999.99 pk.
- X54295 3-Tier Rack only..... 175.99 ea.



Horizontal Hex Dumbbell Rack

Heavy duty 3 tier hex rack!

Tubular steel construction with rubber feet to protect floors. Keeps weights organized, easy to clean. Rack holds one pair each of 5-50 lb. hex dumbbells. Measures 35"H x 48"W x 26"L.

16925 \$239.99 ea.

WEIGHTED BARS



Body Bar Weighted Bars

Perfect for resistance training, stretching, & more!

User friendly and versatile, features foam rubber grip with a solid steel construction and rubber end caps. Color coded by weight. Sold individually. Storage rack sold separately.

- X54297 48" 3 lb. Teal \$26.99 ea. X54301 48" 12 lb. Blue..... \$44.99 ea.
- X54298 48" 4 lb. Red 29.99 ea. X54302 48" 15 lb. Green 49.99 ea.
- X54299 48" 6 lb. Orange 31.99 ea. X54303 48" 18 lb. Yellow..... 59.99 ea.
- X54300 48" 9 lb. Pink 35.99 ea. X54304 48" 24 lb. Black..... 79.99 ea.

12 and 24 Student Workout Bar Class Packs

Popular sizes to meet your class needs. Storage rack sold separately.

- X66762 12 Bar Low Wt. - 4 each: 4 lb., 6 lb., & 9 lb. bars \$359.99 pk.
- X66763 24 Bar Low Wt. - 8 each: 4 lb., 6 lb., & 9 lb. bars 699.99 pk.
- X66764 12 Bar Med Wt. - 4 each: 12 lb., 15 lb., & 18 lb. bars 575.99 pk.
- X66765 24 Bar Med Wt. - 8 each: 12 lb., 15 lb., & 18 lb. bars 1,099.99 pk.

Mini Body Bar Weighted Bars

A shorter version of the Body Bar Classic!

Add resistance to core exercises, perform wrist rotations, and even use in rehab or physical therapy. Solid steel construction. color coded rubber end caps. 24" long. Sold Individually. Storage rack sold separately.

- X54305 4 lb. Red \$29.99 ea.
- X54306 6 lb. Orange..... 31.99 ea.
- X54307 9 lb. Pink 35.99 ea.

12 and 24 Mini Bar Class Workout Pack

Popular sizes to meet your class needs. Storage rack sold separately.

- X66766 12 Mini Bar Set - 4 each: 4 lb., 6 lb., & 9 lb..... \$359.99 pk.
- X66767 24 Mini Bar Set - 8 each: 4 lb., 6 lb., & 9 lb..... 699.99 pk.



Body Bar Storage Rack

Holds up to 30 bars!

Space saving design keeps all of your bars organized. Measures 39"H x25"W x18"D; weighs 40 lbs. Weighted bars sold separately.

- X54308 \$149.99 ea.

Horizontal Storage Racks

Rolls easy on non-marring caster wheels!

Made from solid steel construction and are designed to hold 48 bars 40" or longer. Measures 35"L x 17"W x 47"H; weighs 50 lbs. Weighted bars sold separately.

- X52452 \$259.99 ea.



Mini Body Bar Storage Rack

Hold up to 30 mini bars!

Vertical space saving design. Black finish. Measures 22"H x24"W x12"D; weighs 25 lbs. Weighted bars sold separately.

- X25357 \$129.99 ea.



BARS & COLLARS



OLYMPIC BARBELLS	A. YORK BARRELL	B. TROY BARRELL & FITNESS	C. <i>Body-Solid</i>	D. CAP BARRELL	E. TROY BARRELL & FITNESS	F. CAP BARRELL
	7' Olympic Bar	7' Olympic Bar	7' Olympic Bar	7' Olympic Bar	6' Olympic Bar	Olympic Curl Bar
Test	1500 Lbs.	1200 Lbs.	1000 Lbs.	500 Lbs.	350 Lbs.	200 Lbs.
Grip	32Mm	28Mm	30Mm	1.25"	Medium	1"
Knurl	Side	Light Side	Side	Medium Side	Side	Medium Side
Weight	44 Lbs.	42 Lbs.	44 Lbs.	36 Lbs.	30.5 Lbs.	18 Lbs.
Note	Chrome	Light Commercial	Brass Bushings	Rotating Sleeves	51" Spread	W/Collars
SKU	X52626	X52379	X52604	X52723	X52669	X52724
Price	\$249.99 Ea.	\$219.99 Ea.	\$195.99 Ea.	\$129.99 Ea.	\$124.99 Ea.	\$71.99 Ea.

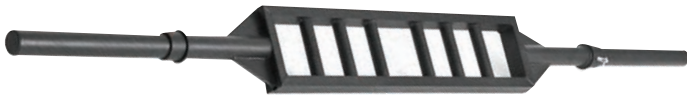

XTREME MONKEY Straight Steel Swiss Bar

Three straight 1" grips per side.
Steel construction. Includes two black steel collars.
Measures 83"L x 7.5"W x 2.75" H; weighs 22 lbs.
X16604 \$130.99 ea.



Tricep Olympic Bar

Features built in collars.
Diamond knurl with a 1" grip. Test weight 200 lbs.
X54162 Measures 34"; weighs 23 lbs. each \$89.99 ea.



Hex Olympic Bar

#1 Hex Bar for high school.
Medium knurl with a 1" grip. Test weight 1000 lbs.
X54161 Measures 56"L; weighs 66 lbs. \$189.99 ea.

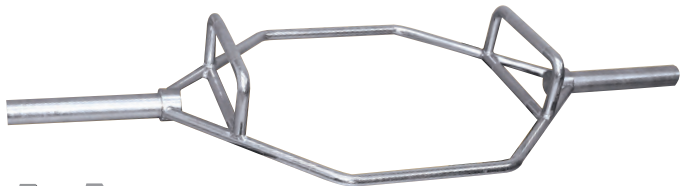

POWRFIT Shrug Bar

For shrugs and dead lifts.
Commercial quality. Knurled and chrome plated. 800 lb. capacity.
X16591 Measures 56" long; Weighs 72 lbs. \$199.99 ea.

OLYMPIC COLLARS

Lock-Jaw Collars

Single action cam lock securely clamps to bar.
Solid nylon injection molded frame and pads.
16594 \$38.99 pr.



Clamp Collars

Turn and lock operation.
Quickly tightens for fast changing of weights.
Made of high impact molded plastic.
52722 \$49.99 pr.

SPORTS HEALTH Barbell Clasp

Rubber interior for grip
Quick release locking for one handed use. Injection molded plastic.
16887 Black \$12.99 pr.



YORK Spring Collars

York® collars with rubber handle.
53191 \$6.99 pr.

OLYMPIC PLATES



CALL QUANTITY FOR DISCOUNTS

Body-Solid Colored Olympic Bumper Plates

Will not break when dropped; helps protect floors. Each plate is fitted with a metal sleeve for proper fit and easy sliding. Solid, high quality rubber.

- X16628 10 lb. Green..... \$83.99 pr.
- X16633 15 lb. Black..... 69.99 pr.
- X16629 25 lb. Yellow..... 129.99 pr.
- X16630 35 lb. Blue..... 156.99 pr.
- X16631 45 lb. Red..... 210.99 pr.



Plate Sets

150 lb. Plate Set includes 2 of each: 15, 25 and 35 lb. plates. 260 lb. Plate Set includes 2 of each: 10, 25, 35 and 45 lb. plates. Ships by Truck.

- T16650 150 lb. Bumper Plate \$349.99 set
- T16651 260 lb. Bumper Plate Set 569.99 set

Body-Solid Black Olympic Bumper Plates

Solid, quality rubber- no crumb rubber! Easy on floors and will not crack or tear. Fitted with a metal sleeve to maintain proper shape.

- X16632 10 lb..... \$62.99 pr.
- X16633 15 lb..... 69.99 pr.
- X16634 25 lb..... 99.99 pr.
- X16635 35 lb..... 127.99 pr.
- X16636 45 lb..... 164.99 pr.



Plate Sets

150 lb. Plate Set includes 2 of each: 15, 25 and 35 lb. plates. 260 lb. Plate Set includes 2 of each: 10, 25, 35 and 45 lb. plates. Ships by Truck.

- T16652 150 lb. Black Bumper Plate \$319.99 **SALE \$294.97 set**
- T16653 260 lb. Black Bumper Plate 519.99 **SALE 489.97 set**

Body-Solid Black Olympic Grip Plate

Heavy duty rubber plates will not scuff, split or mar floors! Plates have metal sleeves to retain shape and provide secure fit to plates. Quad design for easy grip.

- X16643 2.5 lb... \$9.50 pr. X16646 25 lb..... \$96.50 pr.
- X16644 5 lb..... 19.50 pr. X16647 35 lb..... 134.50 pr.
- X16645 10 lb... 39.50 pr. X16648 45 lb..... 172.99 pr.



Plate Sets

140 lb. Plate Set includes 2 of each: 10, 25 and 35 lb. plates. 255 lb. Plate Set includes: 4- 5 lb. plates and 2 of each of 2.5, 10, 25, 35 and 45 lb. plates. Ships by Truck.

- T16656 140 lb. Black Grip Plate..... \$249.99 set
- T16657 255 lb. Black Grip Plate..... 439.99 set

Body-Solid Colored Olympic Grip Plates

Heavy duty rubber plates will not scuff, split or floors! Plates have metal sleeve to retain shape and provide secure fit for plates.

- X16637 2.5 lb Gold..... \$10.50 pr. X16640 25 lb. Yellow . \$103.99 pr.
- X16638 5 lb. Blue..... 21.50 pr. X16641 35 lb. Blue..... 146.50 pr.
- X16639 10 lb. Green..... 41.99 pr. X16642 45 lb. Red..... 187.99 pr.



Plate Sets

140 lb. Plate Set includes 2 of each: 10, 25 and 35 lb. plates. 255 lb Plate Set includes: 4- 5 lb. plates, and 2 of each of 2.5, 10, 25, 35 and 45 lb. plates. Ships by Truck.

- T16654 140 lb. Colored Grip Plate . . \$289.99 **SALE \$269.97 set**
- T16655 255 lb. Colored Grip Plate ... 499.99 **SALE 469.97 set**



YORK BARBELL 300 lb. Olympic Weight Sets

Set includes a 45 lb. bar with 1000 lb. test, pair of spring collars and 14 grip plates: 2 each: 2.5 lb., 10 lb., 25 lb., 35 lb., 45 lb., and four 5 lb. Ships by Truck.

- T53373 Uncoated Cast Iron Set \$419.99 set
- T54149 Rubber Coated Set..... 559.99 set



YORK BARBELL 275 lb. Colored Rubber Bumper Set

Set includes: 2 of each: 10, 25, 35 and 45 lb. colored bumper plates, a 7' long 700 lb. test bar and a pair of spring collars. Ships by Truck.

- T16649 \$539.99 set

RACKS & ATTACHMENTS



Body-Solid Olympic Bar & Plate Rack
Holds 2 bars and stores plates!
Heavy steel construction. Measures 40"H x 20"L x 23"W
X16740 31 lbs..... \$128.99 ea.



Body-Solid Vertical Bar Rack
Holds up to 5 Olympic bars.
Heavy steel base with corner bolt holes to secure to floor. Measures 12"W x 12"L x 9"H
X16741 22 lbs..... \$110.99 ea.



Olympic Weight Tree
With 500 lb. weight capacity!
• Holds 2" olympic weight plates.
• Rubber base to protect floors
• Measures 22.0"L x 18.0"W x 37.0"H
X52901 29 lbs. \$84.99 ea.



Weight Tree & Bar Holder
Holds up to 1,000 lbs. and 2 Olympic bars.
• 2" x 3" & 3" x 3" steel construction
• Powder coated and rubber foot tabs
• Measures 40"H x 20"L x 23"W.
• Plates not included.
X16598 34 lbs..... \$133.99 ea.



Landmine
Commercial grade for durability.
Portable for use in or out of the weight room; includes handle for easy transport. Solid steel. Nonskid rubber bottom. Assembly required. Black. Base: 19.5" L x 16"W. Full bearing construction.
16269 80 lbs..... \$262.99 ea.



Portable Landmine Post
Works with any rubber or iron Olympic plate.
Thumb knob secures bar for stability with an end cap to protect floors. Ideal for any landmine exercises. Swivel design allows for total rotation.
16742 \$46.99 ea.

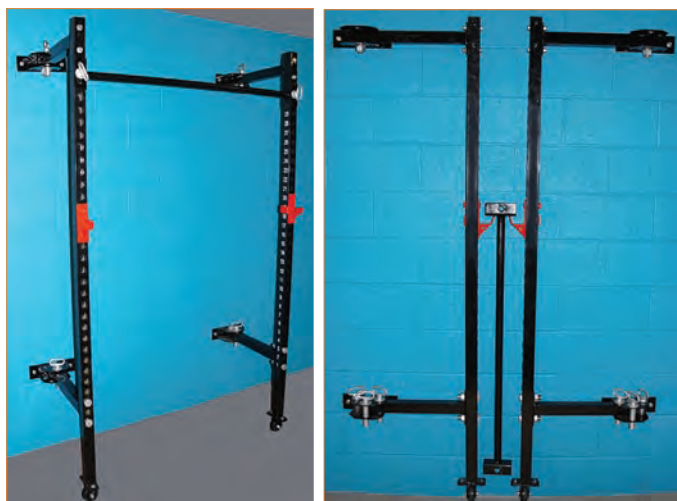

SPORTS HEALTH 2" Power Folding Rack
Folds up for storage!
While it includes J hooks for use for bench and squats, this rack is ideal as a chinning station, bodyweight training or modified pull/push up station. Needs 90" ceiling clearance, includes adjustable height 1.25" diameter knurled chinning bar and high density wheels at bottom of uprights for easy folding. Rack is made from heavy gauge steel, sits 21.5" from wall when expanded, 5" from wall when closed. Measures 48.75"W x 22"D x 84.5"H; weighs 100 lbs.
X16695 \$319.99 ea.

VIEW OUR FULL LINE OF EXERCISE MACHINES AT palossports.com



NEW Body-Solid® R300 Endurance Rower
Professional quality and dynamic features.
The R300 delivers an effective total body workout. An interactive console reports on time, heart rate, calories, paddle width, stroke rate, distance cycle and more. Features 8 preprogrammed exercises. Self-generating power, nickel-plated chain and precision engineered flywheel. Separates for storage. Weight capacity: 330 lbs. Dimensions: 95.1"L x 24.4"W x 39.8"H. Warranty: 15 yr. frame, 3 yr. parts, 2 yr. electronics, 1 yr. labor, 6 mth. wear parts.
29573 Weighs 81.1 lbs..... \$889.99 ea.

ACCESSORIES



SPORTS HEALTH Sports Health Fitness Mega Bands

Create a full body workout without weights! Resistance band loops are an ideal way to build strength, tone muscle and rehab injuries without the hassle of heavy metal free-weights. Comes in a wide variety of resistance levels. 41" long and 3/16" thick.

- 17231 Yellow 5-15lbs, .25"W. . . \$9.99 ea. 17235 Lime 50-125lbs, 1.75"W \$24.99 ea.
- 17232 Red 15-25lbs, .5"W. \$12.99 ea. 17236 Blue 65-175lbs, 2.5"W. \$28.99 ea.
- 17233 Green 25-50lbs, .8"W. \$15.99 ea. 17237 Orange 85-230lbs, 3.25"W. \$35.99 ea.
- 17234 Black 35-70lbs, 1.25"W. . . \$19.99 ea. 17238 Grey 120-300lbs, 4"W. \$39.99 ea.

Fitness Mega Bands Packs

- 54292 Toning Pack (2 ea. Yellow, red, green, black) **SALE \$97.97 pk**
- 54293 Muscle Build Pack (2 ea. Lime, blue, orange, grey)..... **SALE 219.97 pk**
- 54294 Complete Pack (16 Total - 2 of each color)..... **SALE 299.97 pk**



SPORTS HEALTH Lifting Chains

Constructed of heavy duty forged steel! These 60" long loading chains include end hooks. Use one or more chains per bar side to improve strength. Bar collars sold separately.

- X16697 Low 20 lb. \$99.99 pr. X16699 Heavy 50 lb. \$149.99 pr.
- X16698 Medium 30 lb. 99.99 pr. 16700 Collar to Attach Chains 14.99 pr.

Gym Chalk

Get a grip! Fine quality, ideal for weight lifting, climbing walls or gymnastics. Wrapped in 2 oz. blocks, 8 blocks per lb.

- 52306 \$11.99 ea.



SPORTS HEALTH Tricep Rope

1" polypropylene ropes. Nylon end stops are reinforced with fiberglass.

- 16595 24"L \$18.99ea.
- 16596 30"L 25.99 ea.

SPORTS HEALTH

Wrist & Forearm Roller

Strengthens and tones your wrists and forearms. Heavyweight steel construction with rubber grips and nylon rope. Works with any standard size weight plates.

- 52900 \$17.99 **SALE \$13.97 ea.**



Weight Lifting Belts

Top grain genuine leather. 4" wide.

Specify Size \$29.99 ea.

SM-28"-35.5"	MD-31"-38.5"	LG-33"-40"	XL-36"-43.5"	2X-38"-45.5"
52486	52487	52488	52489	52490



ELEMENT FITNESS

Bar Pad

Easily wraps around Olympic bars and provides comfort to neck and shoulders. Made from high density foam padding with a durable nylon cover and Velcro® closure. Measures 14"L with a 3" diameter.

- 16264 \$20.99 ea.



SPORTS HEALTH Head Harness

Helps condition and builds neck and upper back muscles. Constructed of padded high density neoprene to absorb shock and prevent cuts and chafing. Heavy D-rings and steel chain for plate attachment.

- 16268 \$21.99 **SALE \$16.97 ea.**



FREE SHIPPING ON ALL ITEMS ON THIS PAGE!



Body-Solid Preacher Curl

Isolate muscles for maximum workout. Measures: 41"L x 31"W x 35"H; 74 lbs. Ships by truck.
53257 \$395.00 ea.



Body-Solid Flat Bench

Ideal for standard workouts. Measures: 46"L x 23"W x 20"H; 42 lbs. Ships by truck.
53260 \$200.00 ea.



Body-Solid FID Bench

Flat, incline and decline positions. Measures: 57.5"L x 25.5"W x 18"H; 72 lbs. Ships by truck.
16315 \$475.00 ea.



Body-Solid Leg Press/Hack Squat

Variable start/stop positions. Measures: 83"L x 34"W x 56"H; 317 lbs. Ships by truck.
53252 \$1,495.00 ea.



Body-Solid Glute/Ham Machine

Vertical and horizontal adjustments. Measures: 79"L x 33"W x 51"H; 149 lbs. Ships by truck.
16316 \$615.00 ea.



Body-Solid Flat Olympic Bench

2" x 3" main frame construction. Measures: 68"L x 50"W x 48"H; 109 lbs. Ships by truck.
16317 \$765.00 ea.



Body-Solid Squat Rack

Maximize squats and presses. Measures: 80"L x 71"W x 89"H; 343 lbs. Ships by truck.
16318 \$1,450.00 ea.



Body-Solid Multi-Press Rack

Perform squats, calf raises, lunges, dead-lifts, upright rows, and more. Measures 64"W x 45"L x 74"H; weighs 140 lbs. Weight plates, bar and collars sold separately. Ships by Truck.
16752 \$585.00 ea.



Body-Solid 45° Back Hyperextension

Increase flexibility, improve circulation. Measures 26"W x 50"L x 36"H; weighs 108 lbs. Ships by truck.
16751 \$290.00 ea.

FACILITIES



Purell™ Professional Surface Disinfectant

A one-step cleaner and sanitizer that dissipates quickly and cleanly with no streaks or sticky residue. The no-rinse, fragrance-free scent eliminates germs on surfaces, including Norovirus, E. Coli, and Salmonella in 30 seconds. The lowest allowable EPA toxicity rating makes this safe even on food contact surfaces.

- 18240 32 oz. Spray \$12.90 ea.
- 18241 1 Gallon Refill 30.55 ea.



Purell™ Sanitizing Hand Wipes & Wall Dispenser

All the germ-killing benefits of PURELL™, America's #1 instant hand sanitizer, in a non-linting, durable wipe.

Textured for superior cleaning. Sanitizes hands while wiping away light soils and dirt. Kills 99.99% of most common germs that may cause illness. Convenient, easy to use and ideal for school nurse offices, classrooms, locker rooms or anywhere else germs may be.

- 18249 Hand Wipes- 1200 count \$70.65 ea.
- 18239 Wall Dispenser 59.70 ea.



Clorox Bleach-Free Disinfecting Wipes

Tough on germs!

Kills 99.9% of common illness-causing germs, including Staphylococcus aureus (Staph), Salmonella enterica, Escherichia coli (E. coli) and the viruses that can cause colds and flu. Economical and convenient 500 count bucket; refills can be purchased separately.

- 18242 Wipes with FREE Bucket Dispenser, 700 count \$68.50 ea.
- 18243 Wipes 700 Count Refill 59.05 ea.



WIPES ARE:

- Alcohol-Free
- Phenol-Free
- Bleach-Free

2XL Antibacterial Force Wipes

Kills a number of germs and bacteria with formulas that are safe for fitness equipment.

2XL Corporation now provides full spectrum EPA registered disinfectant wipes in a 900 count self-dispensing bucket super-absorbent designed to sanitize all hard surfaces found in gyms, athletic facilities, nursing homes, healthcare facilities, daycare facilities, schools, cafeterias and any environment where sanitation is important.

Features:

- Virucidal: For Feline Calicivirus (FCV), Human Immunodeficiency Virus (HIV-1), and Norovirus (Norwalk Virus) according to criteria established by the U. S. Environmental Protection Agency.
- Bactericidal: For Staphylococcus aureus, Salmonella choleraesuis, Pseudomonas aeruginosa, Escherichia coli, Escherichia coli O157:H7, Methicillin resistant Staphylococcus aureus (MRSA), Vancomycin resistant Enterococcus faecalis (VRE) and Vancomycin intermediate resistant Staphylococcus aureus (VISA) according to criteria established by the U. S. Environmental Protection Agency.
- Tuberculocidal: For Mycobacterium bovis (BCG) according to criteria established by the U.S. Environmental Protection Agency.
- Contains agents that ensure hygiene
- Quick and easy cleanup anytime
- Clean-As-You-Go bucket maintains a healthy and sanitary environment
- Soft and durable towelette that is non-irritating, non-toxic, and non-abrasive
- Environmentally friendly towelette and solution
- Alcohol-Free
- Phenol-Free
- Bleach-Free

- 18244 A: 2XL-400 Antibacterial Force Wipes, 900 Count \$49.10 ea.
- 18245 B: 2XL-401 Antibacterial Force Refills, 900 Count 47.10 ea.
- 18246 C: 2XL-80 Wall Mount Dispenser for 2XL Wipes 47.15 ea.
- X18248 D: 2XL-65 Stainless Steel Stand Dispenser for 2XL Wipes 460.00 ea.

BODYWEIGHT



Lebert Equalizer
Total body strengthener.

Offers hundreds of exercise options with easy to modify exercises to suit the needs of all users. Safe, lightweight and easy to store. Steel construction with powder coat finish. Measures 28.5"H x 25"W; weighs 8 lbs. per bar. Weight capacity of 400 lbs. Sold as a pair.

- X53286 Yellow \$109.99 pr.
- X53905 Lime 109.99 pr.
- X53947 Pink 109.99 pr.

SPORTS HEALTH Suspension Trainer

Trains multiple muscle groups with ease!

Build functional core strength and increase range of motion. Target legs, back, chest, arms and shoulders. Made with heavy grade 1.5" web strapping, easy to adjust low profile cam buckles, padded handles with foot loops and door mount. Compared to other brands, this one exceeds in quality. Includes carry bag.

- 54198 Sports Health Suspension Trainer \$59.99 **SALE \$47.97 ea.**
- 16253 3 Pack 179.90 **SALE 142.97 ea.**
- 16254 6 Pack 359.90 **SALE 286.97 ea.**



XTREME MONKEY Paralettes

Built like a tank!

Steel construction with sturdy bases for explosive swing throughs or weighted handstand pushups. Measures 24"L x 13"H, sold as a pair.

- X16926 \$80.99 pr.

VULCAN Pegboard

A dynamic and challenging upper body strength and conditioning tool.

Maple wood board with stainless steel end protector plates. The board features 35 staggered holes and can be mounted vertically or horizontally. Includes 2 pegs and mounting hardware. Measures 95.5"L x 11.75"W x 1.5" thick. Weighs 42 lbs.

- X16947 \$328.00 ea.



Peg Board Climbers

Made of hard maple.

Mount singly, in blocks, or as many as you wish. Arrange them in any shape or pattern. Hand made and hand finished, triple coated varnish with machine drilled holes. Two size boards; 6'L x 6"W & 1.5" thick or 6'L x 12"W & 1.5" thick. Each board comes with one pair of pegs. Mounting kit for concrete or brick is additional.

AVAILABLE
IN 2 SIZES

- X28012 29 holes 6' x 6" \$179.99 ea.
- X28016 38 holes 6' x 12" 299.99 ea.
- X28018 Mt. Kit for 6' x 6" 72.99 ea.
- X28019 Mt. Kit for 6' x 12" \$77.99 ea.
- 28094 Extra pegs 11.99 pr.



POWRFIT™ Wall Mount Dip Station

Handles fold to save space!

Features 6" long 1.25" diameter hand grips and supports up to 500 lbs. Handles extend 17" from wall. Mount on 16" center studs. Unit measures 23" long. Includes mounting hardware.

- 16600 \$99.97 **SALE \$99.97 ea.**

SUSPENSION TRAINING



NEW

TRX Sweat System
Built to increase strength, power and endurance.

Updated from top to bottom with adjustable foot cradles, padded foam handles and pinstripe webbing for greater comfort, functionality and durability. Also includes: Door & suspension anchors, mesh bag, poster & 6 month TRX app subscription plus 6 video workouts. Weight: 1.5 lbs.

- 17381 TRX Sweat Single..... \$179.95 ea.
- 17382 TRX Sweat 3 Pack 539.85 pk.
- 17383 TRX Sweat 6 Pack 1,079.70 pk.



NEW

TRX Pro Suspension Trainer

The most versatile bodyweight trainer available from TRX.

Designed for the heavy use, TRX Pro has textured rubber handles, upgraded webbing, adjustable and padded foot cradles, and a locking carabiner. Also includes: Extender strap, door & suspension anchors, mesh bag & 1 year TRX app subscription. Weight: 2 lbs.

- 17378 TRX® Pro Trainer Single \$249.95 ea.
- 17379 TRX® Pro Trainer 3 Pack 749.85 pk.
- 17380 TRX® Pro Trainer 6 Pack 1,499.70 pk.
- 16085 TRX® X-Mount -Measures 4.5" 39.95 ea.



16085



TRX Commercial Suspension Trainer

Perform hundreds of exercises without heavy weights.

Constructed of commercial-grade materials, and built heavy use. Comes textured, ergonomic rubber handles, padded foot cradles and a locking carabiner. Also includes an extender strap higher anchor points. Weight: 2 lbs.

- 16082 TRX® Trainer Single \$209.95 ea.
- 16083 TRX® Trainer 3 Pack 629.85 pk.
- 16084 TRX® Trainer 6 Pack 1,259.70 pk.



TRX MultiMount

With monkey bars!

Sturdy, industrial-grade steel, wall mounted pull-up bar provides stations for TRX® users. Ideal for small spaces. Includes installation instructions and safety guidelines. Professional installation is recommended. Ships by truck.

- T16088 7' long; 3-4 users \$699.95 ea.
- T16089 14' long; 5-6 users 1,129.95 ea.
- T16090 21' long; 7-8 users 1,549.95 ea.



XTREME MONKEY Gym Rings

Strong yet lightweight!

Made from tough ABS plastic, the rings are attached to 1" wide nylon webbing that's 14' long. Easy to adjust and mount to overhead fixtures. Maximum weight capacity is 350 lbs.

- 16289 \$69.99 set



Smart Suspension Trainer

Self-guided exercises printed on straps!

Easy to adjust straps for required length. Two separated straps for desired width. Features pre formed foot cuffs, built in anchors on each strap and a strap connector.

- 16927 \$99.00 ea.
- 16928 3 pack 297.00 pk.
- 16929 6 pack 594.00 pk.

CHINNING BARS



XTREME MONKEY Chin Up Bar
Mount to a wall or ceiling!

Bar is set 33" out from the wall allowing for flexibility of use. Ideal for anchoring rings, suspension trainers or bands. The 45" long bar itself has a textured powder coat finish for grip and is bolted flush to the support brackets so there is no play or movement. Features a 2' vertical wall attached bracket and a 7 hole bolt pattern on each bracket. Maximum weight capacity is 880 lbs. Mounting hardware included, be sure to consult a professional for installation. The Bar Add On Attachment includes a 45" long bar with one 2' vertical wall attached bracket to lengthen the chin up station.

45" ADD ON BAR
ALLOWS FOR MORE USERS AT ONE TIME

- X16291 45" Chin Bar..... \$143.99 ea.
- X16292 45" Add On..... 105.99 ea.



XTREME MONKEY Ceiling Mounted Multi-Grip Chin Up Bar
Diamond knurling for excellent grip!

Bolted flush to the support brackets so there is no play or movement, just a solid fixture with a weight capacity of 880 lbs. Measures 45"L x 9"W x 16"H. For Light Commercial use. 4 bolts supplied for installation. Seek professional advice for proper installation.

- 16845..... \$112.99 ea.

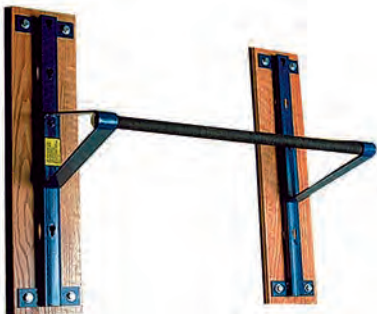

30" Deluxe Wall Chinning Bar

Perfect for elementary thru university level use. Provides 2' of height adjustments in 6" increments. All welded 30"W steel framework with powder coated finish. Oak back mounts not included. Maximum weight capacity 250 lbs.

- X25034..... \$179.99 ea.



SPORTS HEALTH Wall Mount Kip Chin/Pull Up Bar

Bar is 27.5" from wall for swinging movements. Constructed from 2" x 1" heavy wall tube with 1.25" diameter knurled 48" long bar. Measures 30"D x 24"H x 50"W and weighs 30 lbs.

- X16603 48" Kip Chin/Pull Up Unit..... \$109.99 SALE \$99.97 ea.



32" Adjustable Chinning Bar

The finest bar available at this price. Sturdy steel construction with 1.25" plated steel hand grip and two wall brackets made to mount to any wall. Set on 32" centers, easily adjusted in 6" increments by simply lifting bar and placing to desired height. No hardware included. Shipping weight: 22 lbs. Maximum weight capacity 300 lbs.

- X25066..... \$139.99 ea.



Lifeline^{USA} Pullup Revolution™

Excellent for beginners and advanced users! Adjustable, assisted pull ups allow users to get more repetitions, focus on proper technique and get a better workout. New users will have more success and gain confidence. Simply attach the web strap with metal buckle to your bar and adjust the cable length which adds about 100 lbs. of assistance. Cables can be removed for less assistance. Includes strap, 3 cables, manual and DVD with challenging activities.

- 53285..... \$39.99 ea.

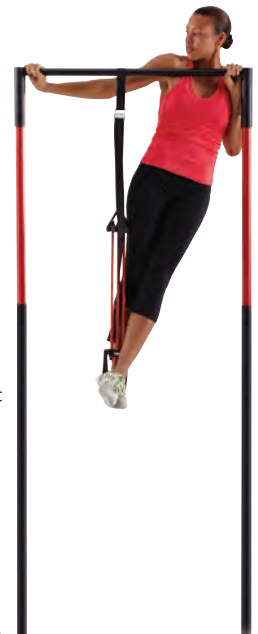

JUMP ROPES

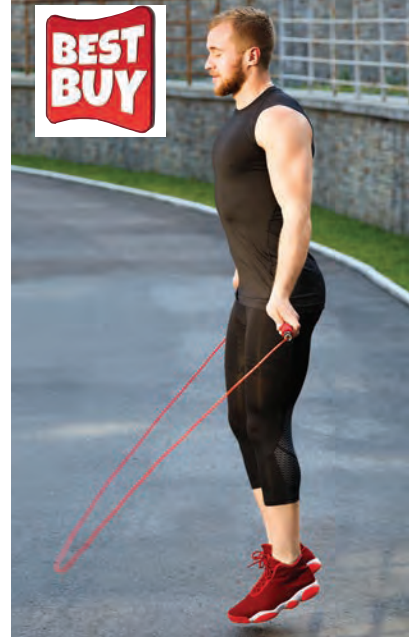

SPORTS HEALTH Speed Ropes

Available in 3 lengths!

Relaxed vinyl rope straightens out quickly and twirls great. Handles are contoured with ball bearings for smooth swivel.

Sz.	Color	Each		6 Pack		
8'	Black	12169	\$9.99 ea. SALE \$4.97 ea.	12126	\$29.82 pk. SALE \$24.97 pk.	
9'	Red	12170	9.99 ea. SALE 4.97 ea.	12127	29.82 pk. SALE 24.97 pk.	
10'	Blue	12171	9.99 ea. SALE 4.97 ea.	12128	29.82 pk. SALE 24.97 pk.	



Double Bearing Speed Rope Set

Adjustable screws allow length change.

Made with a 3mm durable wire cable with a 15cm ergonomic handle with double bearing. 9' length.

12161 SET OF 6 \$29.99 set

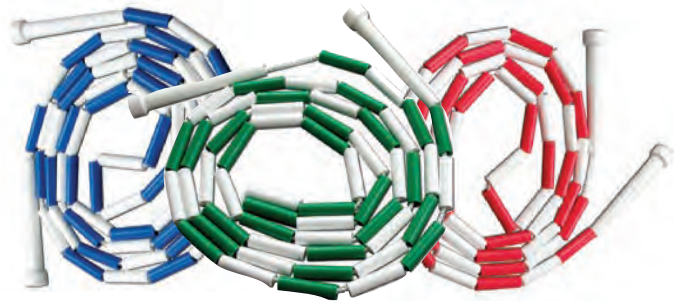

Kanga® Beaded Ropes

The highest quality segmented jump rope on the market!

With a slightly thicker, multi-weave nylon rope and near unbreakable plastic segments, these ropes have nice balance and will last.

Sold by the dozen.

12101 7' Red/White	\$63.99 dz.
12102 8' Blue/White	66.99 dz.
12103 9' Green/White	69.99 dz.
12104 10' Yellow/White	74.99 dz.

XTREME MONKEY

Weighted PVC Jump Rope

Ergonomic handles for comfort!

Handles are a little over .5 lb. each to give a bit extra effort in training. PVC rope flies true with excellent rotation.

12117 9' \$16.99 ea.



Weighted Jump Ropes

Add an extra kick to your cardio workout!

Made of solid rubber with foam covered swivel ball bearing handles. All ropes are 9' long.

12082 1 lb. Green	\$24.99 ea.	12084 3 lbs. Yellow	\$41.99 ea.
12083 2 lbs. Orange	28.99 ea.	12085 4 lbs. Blue	47.99 ea.



ZONE Multi-Use Wall Rack

Organize by size!

This convenient rack/holder will allow you to "untangle" the mess and hang jump ropes out of the way by size and type. Steel rack is 2"W x 24"L. Five 12" pegs will hold 100 jump ropes. Mounting hardware included.

36172 \$41.99 SALE \$34.97 ea.

CORE



SPORTS HEALTH Ab Straps

Ideal for training the hard to hit lower abdominals.

Made with heavy duty 2" wide nylon straps with padded arm bands for comfort. Steel 6" screw lock carabiners secure easily to bars. Sold in pairs. **54206**.....**\$37.99 SALE \$26.97 pr.**



Bottom: Low friction hard urethane

Top: Firm, foam grip pattern gives traction for hands and feet

GoFit Go Slides

Use anywhere to build core strength and increase flexibility!

Designed with a low-friction, non-marking, material to slide smoothly on virtually any surface. The firm, foam grip pattern on the top side, means ideal traction for hands and feet. Large surface area is easier to use and maneuver. Each Slide measures 10.5" x 7.5". Includes 2 Go Slides, a carry bag and training manual.

54310.....**\$29.99 set**

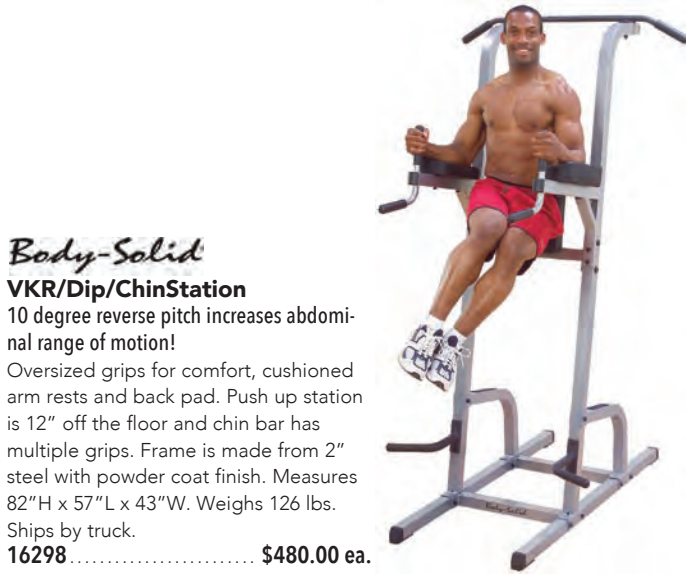

Body-Solid VKR/Dip/ChinStation

10 degree reverse pitch increases abdominal range of motion!

Oversized grips for comfort, cushioned arm rests and back pad. Push up station is 12" off the floor and chin bar has multiple grips. Frame is made from 2" steel with powder coat finish. Measures 82"H x 57"L x 43"W. Weighs 126 lbs. Ships by truck.

16298.....**\$480.00 ea.**



SPORTS HEALTH Slider Discs

For hardwood or tile floors!

Maximize workouts with the versatile disc by increasing strength and flexibility in your upper and lower body. Polyester covered slide discs have soft foam centers for comfort with strong stitched seams. 9" diameter.

Not designed for use on carpets.

16722 5 Person Pack- 10 Slider Discs **\$43.99 SALE \$34.97 pk.**
16723 25 Person Pack- 50 Slider Discs & Bag **324.95 SALE 169.97 pk.**



Pro-Style Ab Board

Adjusts to 12 positions.

Strong 2" x 2" steel main frame with thick DuraFirm™ padding and oversized 8" foam rollers for comfort. Measures 54"L x 24"W x 52"H; weighs 46 lbs.

X53250.....**\$275.00 ea.**



ELEMENT FITNESS Glide Discs

Target your glutes and thighs and work your entire body!

Great for multi-surface areas, these discs deliver constant resistance, adding intensity to your lunges, squats and upper-body workouts. With virtually every move, you'll engage your core, giving you amazing abs, glutes and thighs! Two double-sided sliding discs: blue smooth side for carpet, black fabric side for hard surfaces and wood. Discs are 7" in diameter and sold in pairs. Group Pack includes 10 pair of Glide Discs.

16251 Glide Discs.....**\$13.99 pr.**
16252 10 Pair Group Pack.....**139.90 pk.**

CORE



SPORTS HEALTH Toning Wheel

Trims and tones waistline while strengthening the back.

Dual wheels for stable operation, rubber contoured handles for secure, comfortable grip.

52070..... \$13.99 **SALE \$9.97 ea.**



SKLZ Core Wheels

Take your planks and push ups to a new level!

Develop dynamic core strength and improve flexibility. With ergonomic foam handles for comfort and 5.7" wheels on each axle designed to allow for increased exercise variations to target the upper body area.

53917..... \$35.99 **pr.**



GoFit Power Ab Wheel

Targets upper and lower abdominals.

Features dual wheels with wide treads and grippy traction surface with non-slip ergonomic rubber handles. Heavy duty, clear urethane wheel hubs for smooth rolling. Wheel diameter 7".

53949..... \$19.99 **ea.**



Pivoting Push Up Pods

Offers an unstable base that forces your body to build strength and stamina.

Made from heavy duty plastic with a rubberized bases and handles for grip. Base measures 7.75" in diameter. Pods snap together for storage.

16968..... \$19.99 **pr.**



NEW

GoFit Core Ab Ball

Maximize the time you spend strengthening your abdominals.

The Ab Ball intensifies work for the middle muscles and provides more effective toning for the abs. Includes: 20cm Ab Ball, training DVD, and inflation tube.

54336..... \$19.99 **ea.**



Abdominal Mat

Works all abdominal muscle groups!

Use with a variety of exercises that isolate upper and lower abs as well as the obliques and lower back muscles. Ideal for any fitness level the mat provides support and helps prevent injury. Durable with foam cushion base and a thick vinyl cover.

53978 Abdominal Trainer..... \$32.99 **ea.**

53979 Mat 6 Pack..... 184.99 **pk.**



Push Up Bars

Builds strong upper body muscles.

These convenient bars help reduce stress on the wrists and elbows and allow deeper dips to stretch muscles. Comfortable foam hand grips and protective non-skid feet.

52045..... \$10.99 **SALE \$8.97 pr.**



Power Cross Challenge

Follow the hands across the mat for a great upper body and core workout!

Three color levels of difficulty from elementary through high school. Ideal for stations, warm ups or obstacle courses. Carpeted mat with non-skid backing; measures 10'L x 30"W.

X53919..... \$159.99 **SALE \$139.97 ea.**

BOXING



Pro Style Training Gloves
Mesh palm with anti-microbial lining!
Hook and loop strap for ease of use and durable, long lasting synthetic leather.
52193 12 oz. \$39.99 pr.



Neoprene Heavy Bag Gloves
Soft neoprene to protect hands!
Durable construction with mesh palm with anti-microbial lining one size fits most.
52192 12 oz. \$19.99 pr.



Partner Training Kit
Gloves and mitts have anti-microbial lining!
Synthetic leather glove with neoprene palm and full glove backing on punch mitt. Set includes 2 gloves and 2 punch mitts
53836 \$36.99 set



Everlast Mitt & Glove Pack
Our top sellers!
Pack includes a pair of neoprene heavy bag gloves and Mantis Punch Mitts.
16965 \$56.99 pk.



Mantis Punch Mitts
Curved for hand safety and comfort. Moisture absorbing and anti-microbial lining with mesh back for breathability and comfort.
53835 \$43.99 pr.



Everlast Leather Punch Paddles
Ideal for practicing various strikes and punches.
Unique grip allows a trainer to feel less impact on the hand and wrist. High quality leather construction with closed cell C3 foam for increased cushioning. Sold in pairs.
16261 \$59.99 pr.



Strike Shield
Promotes uppercuts and angle punches. Great partner workout tool! Multiple straps for hand placement, made from premium synthetic leather with high density foam padding.
X53539 \$51.99 ea.



Leather Speed Bag
With nylon reinforced lining.
• Balanced for accurate rebounds
• High grade leather construction
• Swivel not included
• Measures 10" x 7"
53541 Leather Speed Bag \$39.99 ea.
53542 Replacement Bladder 6.99 ea.
53544 Swivel 21.99 ea.



C3 Foam Heavy Bag
Cushioned polycanvas wrap provides increased cushioning. Premium NevaTear™ cover with reinforced webbing and Blended filler mix fibers for resilient shock absorption Heavy duty straps for security with double end loop. Measures 50.3" L x 14.3" diameter.
X53837 100 lbs. \$134.99 ea.



Cardio Wavemaster™
For a complete body workout!
Striking surface is 40" long with a 10.5" diameter and high density foam inner with a poly shell. Low profile 22" diameter base can be filled with sand or water to provide approximately 170 lbs. ballast when filled. Designed with 4 height adjustments from 53" to 65" tall.
X52159 Black \$149.99 ea.
X52160 Red 149.99 ea.
X52161 Blue 149.99 ea.



Century® Heavy Bags
Built tough for combat sports!
High tensile strength Diamond Tech™ fabric cover. Filled with sand bags, shredded cotton and polyester fibers. Durable web straps for hanging.
X52190 70 lb. 40"L x 13" diameter \$106.99 ea.
X52191 100 lb. 42"L x 14" diameter 119.99 ea.



Fight Monkey® Heavy Bag Wall Mount
Pull pin adjusts swivel to side when not in use!
Attaches to any standard wall and holds up to 100 lb. heavy bag. Arm extends 27" away from the wall, and can be swiveled to either side when not in use. Bag not included.
X52183 Wall Mount only \$99.99 ea.

Photo ©2009 Century, LLC. Wavemaster™ is a registered trademark of Century, LLC.

FLOORING

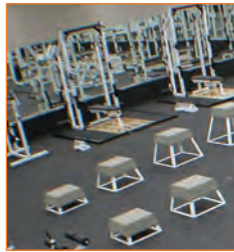

Interlocking Rubber Flooring

Top quality EPDM rubber is 100% recycled.

Reduces noise, provides anti-fatigue benefits and protects floors from damage. Interlocks seamlessly for a smooth appearance. Connecting tabs are over 6" wide and 4" deep and will not separate. Easy to install with no adhesive necessary. Keep clean by sweeping, vacuuming or lightly mopping. Easy to sanitize. Constructed for indoor or outdoor use. Available in 2 thicknesses, 1/2" and 3/4" and your choice of colors. Tiles measure 30" x 30" and are available in center, edge and corner cuts. Available in red gray, green and blue. **Call for freight quote-** our regular shipping policy does not apply to this product.

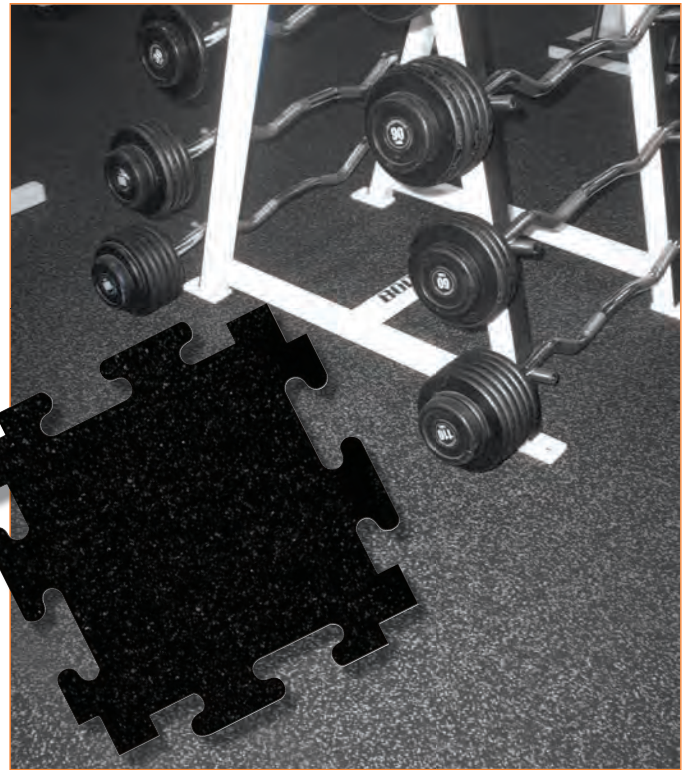

THICKNESS	SOLID BLACK		THICKNESS	FLECK COLOR	
Center- .5"	C52637	\$26.50 ea.	Center- .5"	C52643	\$31.99 ea.
Corner- .5"	C52638	26.50 ea.	Corner- .5"	C52644	31.99 ea.
Edge- .5"	C52639	26.50 ea.	Edge- .5"	C52645	31.99 ea.
Center- .75"	C52640	27.99 ea.	Center- .75"	C52646	35.50 ea.
Corner - .75"	C52641	27.99 ea.	Corner- .75"	C52647	35.50 ea.
Edge- .75"	C52642	27.99 ea.	Edge- .75"	C52648	35.50 ea.



3/8" Thick Rolled Flooring

Two different lengths to accommodate your needs.

Each roll is 4' wide and made from 100% recycled rubber. Available in solid black or with color fleck.

Can be laid flat or adhered to floor with double sided tape or polyurethane based adhesive. Call for freight quote- our regular shipping policy does not apply to this product.



SIZE	SOLID BLACK		FLECK COLOR	
25'L x 4'W Roll	C52631	\$264.99 ea.	C52634	\$345.99 ea.
50'L x 4'W Roll	C52632	\$299.99 ea.	C52635	\$692.99 ea.

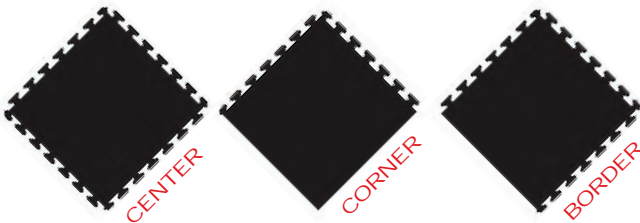

Interlocking Floor Tile

Extremely dense, resilient and wear resistant!

Absorbs shock of noise and training impact. Made from 100% post consumer tire rubber and post industrial EPDM rubber. Using these tiles can qualify your facility for LEEDS credits. Each tile measures 24" x 24" and is 3/8" thick. Choose center, corner and border pieces. **Call for a freight quote-** our normal shipping policy doesn't apply to this product.

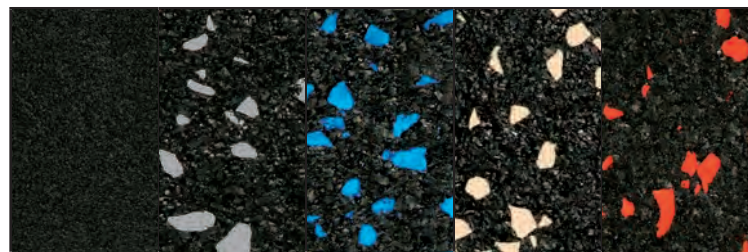

COLOR	SOLID BLACK	GRAY FLECK	BLUE FLECK	TAN FLECK	RED FLECK
	SKU				
CENTER	C16330	C16333	C16336	C16339	C16342
CORNER	C16331	C16334	C16337	C16340	C16343
BORDER	C16332	C16335	C16338	C16341	C16344
PRICE	\$12.99 ea.	\$12.99 ea.	\$12.99 ea.	\$12.99 ea.	\$12.99 ea.

STEPS

NEW

The Original Step®

The step that started a revolution.

Not just for leg workouts, The Step® can be use horizontally, or on an incline, and adjusts from 4" to 6" to 8" using the included risers. Large 40"L x 14"W stepping area with non-slip ribbed surface. Supports up to 350 lbs. Measures 43"L x 16"W. Class Pack includes: 10 platforms, 40 risers, 1 step cart - 36013 & 1 riser cart - 36014. (See page bottom for cart details.)

- X52865 Single - 1 platform & 4 risers \$94.95 ea.
- T52866 10 Pack - 10 platforms & 40 risers 999.99 pk.
- T66175 12 Pack - 12 platforms & 48 risers 1,199.99 pk.
- T66807 Class Pack - 10 platforms, 40 risers, step cart & riser cart . 1,329.99 pk.



NEW

The Step® Stackable Riser

A unique, stackable step that does not require risers.

Choose from 4" or 6" models. Platform top features nonslip, textured surface while the bottom includes eight nonskid feet for extra safety. Sizes may be used together to achieve desired height. Measures 22"L x 12"W.

- X54337 4" Gray \$22.99 ea.
- X54339 6" Blue 29.99 ea.
- X54338 4" Gray - 10 Pack..... 229.99 pk.
- X54340 6" Blue - 5 Pack..... 149.99 pk.



ELEMENT FITNESS Aerobic Fitness Step

Stable platform for intense workouts!

Excellent non-slip ribbed surface allows users a solid grip whether it's for feet or hands! The fitness step itself is 43"L x 16"W x 4"H with the support blocks adjusting the height from 4" to 6" or 8". Includes 1 platform and 4 risers. Maximum user capacity is 300 lbs. Rack stores 6 steps and risers. PVC construction with smooth rolling casters (X36013). Measures 44"L x 19"W x 62"H and weighs 33 lbs.

- X16262 Aerobic Fitness Step..... \$78.99 ea.
- 16263 Aerobic Step Class 10 Pack- 10 platforms & 40 risers 839.99 pk.
- 16950 6 Pack- 6 Platforms & 24 Risers & Rack 829.99 pk.
- 16951 12 Pack- 12 Platforms & 48 Risers & 2 Racks 1,599.99 pk.



Fitness Step Cart

Holds up to 20 6" steps plus uprights for resistance tubing.

Constructed of PVC plastic with non slip grips on bottom shelf and 3" ball bearing casters. Measures 45"L x 19"W x 60"H. Steps not included.

- X29300 \$198.99 ea.



Riser Cart

For use with the risers of The Step™.

Holds up to 60 step risers. Built from structural grade PVC that will not rust, corrode, chip or peel. Measures 46"L x 19"W x 42"H. Risers not included.

- X36014 \$205.99 ea.



Step Cart

For use with The Step™.

Step cart transports up to 12 steps on smooth rolling, non-marring swivel casters. Built from structural grade PVC. Measures 46"L x 19"W x 60"H. Steps not included.

- X36013 \$224.99 ea.

CORE STABILITY



Stephanie Joanne Trampoline

A complete workout from fitness guru Stephanie Joanne!

Rebound to strengthen the heart and muscles. Strong steel base folds for storage with durable safety apron and a 27" diameter jumping area. Trampoline measures 40" in diameter and 10" in height. Includes stabilizer bars for balance that's easy to remove. Max. weight capacity is 225 lbs. Class Pack includes 12 trampolines and ships by truck.

- 16953 Stephanie Joanne Trampoline \$121.99 ea.
- T16954 Stephanie Joanne Trampoline Class Pack 1,349.99 pk.

Urban Rebounder® Class Pack

The powerful total body workout that is in nearly 3000 health clubs worldwide.

An excellent fat burning workout that strengthens your core abdominal posture, improves your cardio endurance and improves your balance and coordination. The Urban Rebounder® is a heavier rebounder than a normal mini tramp with elevated angled position, works calves and quads to the maximum! Designed to hold a 90 lb. dancer or a 300 lb. football player. It is made of high yield steel; constructed with jumbo tapered springs and steel pins and a 1000 count stitched 40" surface. Includes hand rail that can be removed for different workouts. The legs fold for easily stackable storage. Class Pack includes: 12 Urban Rebounders® and 12 workout DVD's. Kids Bound DVD includes 4 workouts & Urban Rebounding DVD includes 6 workouts.



- X52579 Urban Rebounder® & DVD \$119.99 ea.
- T52590 Class Pack-ships by truck 1,349.99 pk.
- 39111 Kids Bound DVD 27.99 ea.
- 39112 Urban Rebounding DVD 27.99 ea.



ELEMENT FITNESS SlideMate Horizontal Trainer

Provides lateral strength, power and endurance.

Includes the durable, super slick slideboard and a pair of nylon booties. Measures 6' long.

- 16952 \$104.99 ea.



Mini Trampoline

Excellent aerobic workout!

Features a 38" diameter sturdy steel frame, heavy duty polypropylene jumping mat and Bungee Straps for great rebound! Some assembly required. Unit weighs 17.5 lbs.

- X52087 \$66.99 ea.

BALANCE



BOSU® Pro Balance Trainer

BOSU® Pro Balance Trainer challenges the entire body with integrated, multi-joint movement that requires muscle groups to work together. Use the BOSU® Pro Balance

Trainer dome or platform side down, combine it with other equipment, or use it as a stand-alone product to make any exercise fun, challenging, and effective. Inflates up to 9" high with a 26" diameter. Maximum weight capacity 350 lbs. 1 year limited warranty.

- 52276 Bosu® Pro Balance Trainer..... \$159.95 ea.
- 52277 Pro Quad Pack- 4 Pro Trainers only 599.99 pk.
- X52244 Pro 16 Pack- 16 Pro Trainers only 2,019.99 pk.
- X51022 Pro 6 Pack with Cardio Fusion DVD & Cart..... 999.99 pk.



BOSU® Sport Balance Trainer

A smaller version of the original BOSU® Pro Balance Trainer.

Constructed with the same rim and base style. The sleek, compact design allows for easy transportation and storage. The smaller size offers a variety of configuration, stance, and workout options. Inflates up to 7" high with a 22" diameter. Maximum weight capacity 250 lbs. 90 day limited residential warranty. Includes trainer, foot pump and manual.

- 52907 \$99.99 ea.
- 54315 Sport 4 pack..... 388.99 pk.



Balance Dome
Develop core stability and strength.

Use for multiple exercises and can be used upside down for additional Adaptive PE activities. Made from strong vinyl construction. Dome measures 8" high when inflated and has a 17.5" diameter.

- 16669 \$46.99 ea.



BOSU® NexGen™ Balance Trainer

A budget friendly version of the popular Pro model.

Rated for recreational and personal use, the BOSU® Balance Trainer gives you all of the functionality and options received from the Pro model, while keeping costs low. Holds up to 300 lbs., 26"D x 10"H (inflated). Weighs 19 lbs. Includes hand pump and manual.

- 54313 Single Trainer \$109.99 ea.
- 54314 Balance Trainer 4 pack..... 439.99 pk.



BOSU® NexGen™ Pro Balance Trainer

Textured design enhances functionality for grip & positional cueing.

Four easy to distinguish quadrants allow for precise body positioning for cardio, agility, strength, core and more! Markings also enhance hand and foot grip. Heavy-duty commercial grade materials. Holds up to 350 lbs., 26"D x 10"H (inflated). Weighs 19 lbs. Includes hand pump and manual.

- 54311 Single Pro Trainer..... \$169.99 ea.
- 54312 Pro Trainer 4 pack..... 679.99 pk.



BOSU® 6 Cart

Stores 6 Bosu® Trainers.

Single column, heavy-duty gauge steel with swivel casters. Measures 24" L x 20.5"W x 71.5"H and weighs 16 lbs.

- X51021 \$187.99 ea.



BOSU® 14 Unit Storage Rack

Stores 14 Bosu® Trainers.

Two column, heavy-duty, steel storage cart comes with swivel caster wheels. Measures 49.5" L x 25" W x 76" H and weighs 58 lbs.

- 54316 \$299.00 ea.

BALANCE



SPRI Balance Pods

Improve balance, body awareness and coordination!

Arrange with flat side down or up for varied levels of difficulty. Pods are made from heavy duty vinyl, air injected and measure 6.25" x 3.5". Sold as a set of 6 assorted color pods. Includes instruction sheet.

13051 \$42.99 set



NEW

GoFit CoreStability Disk

Helps develop stability and core strength.

Features a reflexology (textured) side and smooth side. Vary difficulty by increasing or decreasing inflation. Includes disk, manual and inflation needle. 13" D.

17415 \$23.99 ea.



15" Tri Level Balance Board

Adjusts to 3 heights!

15" diameter board made from molded ABS construction with textured top for grip. Increase challenges by adjusting up to 4" maximum.

13071 \$29.99 ea.



NEW

TheraBand® Stability Trainer

Helps to attain stability and prevent painful sprains or injuries.

These trainers are designed to improve limb positioning, joint stability, reflex action, coordination, and strength and agility. The dual surface, non-slip pad can be used for single leg stance exercise or other balance exercises that work the core and build abdominal strength. Made of closed cell foam. Choose from 2 densities.

SH61261 Firm (Green) - 14.5"L x 8"W x 1.75" \$37.99ea.

SH61262 Soft (Blue) - 16"L x 9"W x 2"H. 37.99 ea.



Stability Fit Pads

Ideal for balance training, coordination and posture improvement.

Increase difficulty for progressive training by inflating or deflating. One side features spiky bumps while the other side has a round bump. Measures 13.5" in diameter. Available in a set of 6 neon colors.

13151 SET OF 6 \$99.99 set

ELEMENT FITNESS

Balance Pods

Challenges core stability and improves balance.

Use on either side for varied levels of difficulty. Vinyl construction with tactile top and smooth bottom. Approximately 7" each.

13153 \$19.99 pr.



ELEMENT FITNESS

Balance Pad

Combine both exercise and coordination skills.

Soft, closed cell foam with thick covering that's easy to clean and extremely durable. Measures 16.5"L x 15"W x 2.5" thick.

X16959 \$41.99 ea.



NEW

AIREX® Balance Beam

An excellent alternative to traditional balance boards.

The AIREX® balance beam provides a semi-unstable surface for improving balance, alignment, proprioception, stabilization and coordination. Made from "super-soft" closed cell foam. The extended length provides greater surface distance for walking toe-to-heel and thus improving stability and coordination. 63"L x 9"W x 2.5"H.

SH61643 \$164.99 ea.



STABILITY BALLS



SPORTS HEALTH Exercise Balls

All purpose anti-burst fitness ball.

Rotation molded with raised ribs, anti-burst design and non-slip surface. Maximum weight 300 lbs. Available in 3 sizes.

- 10362 45cm/18" Yellow..... \$19.99 **SALE \$14.97 ea.**
- 10363 55cm/22" Blue..... 21.99 **SALE 16.97 ea.**
- 10364 65cm/26" Red..... 22.99 **SALE 18.97 ea.**



GoFit Premium Stability Balls

A premium quality anti-burst fitness ball!

Designed for fitness use, these stability balls are burst resistant, weight tested to 1000 lbs. and latex free! Made with a non-slip surface.

Colors may vary.

- 52321 55cm/22" Red..... \$19.99 ea.
- 52322 65cm/26" White..... 19.99 ea.
- 52323 75cm/30" Blue..... 19.99 ea.



Smart Stability Balls

Features 13 exercises printed on the ball!

Balls are rotationally molded PVC with a non-slip surface and 1000 lbs. anti-burst tested. Includes pump. Rack is made of .25" thick steel and measures 70"L x 5"W. Rings protrude from wall about 22".

- 16960 55cm yellow \$29.00 ea.
- 16961 65cm green 34.00 ea.
- 16962 75cm blue 39.00 ea.
- 16963 Stability Rack Pack- includes one of each ball & rack 329.00 pk.
- 16964 Stability Rack only 229.00 ea.



Premium Stability Ball Class Packs

9 balls and 6 poster pack!

Includes 9 balls and 2 posters featuring stretch, back and abs exercises!

- 66507 55cm/22" Black 9 Ball Pack with 2 Posters..... \$209.99 pk.
- 66508 65cm/26" Lt. Blue 9 Ball Pack with 2 Posters..... 209.99 pk.
- 66509 75cm/30" Dk. Blue 9 Ball Pack with 2 Posters..... 209.99 pk.
- X36185 Optional 9 Ball Cart- measures 62"L x 18.5"W x 67"H..... 159.99 ea.



Fitness Ball Storage Carts

Assembles in minutes!

Sturdy carts are made from heavy duty PVC with non-marring swivel casters.

- X36185 9 Ball Cart- 62"L x 18.5"W x 67"H \$159.99 ea.
- X36164 12 Ball Cart- 107"L x 19"W x 68"H 209.99 ea.

SPORTS HEALTH Fitness Ball with Legs

Unique design keeps the ball from rolling away!

Promotes correct posture. Legs retract when weight is placed on the ball. Use for strength training, conditioning, and even in the office.

- 18251 \$19.99 ea.

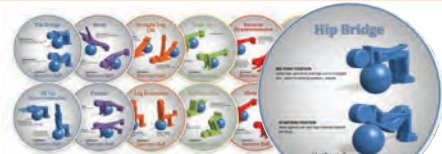

HotSpots® Exercise Ball

12 Body Balls HotSpots: Hamstring Press, Push Up, Hip Bridge, Straight Leg Lift, The Pointer, Reverse Hyperextension, Leg Extension, Sit Up Extension, Ball Reverse, The Swan, Glute Lift and Scissor Kick.

- 21140 \$44.99 set

WHICH FITNESS BALL IS RIGHT FOR YOU?



PLYOMETRICS



GoFit Premium Wood Plyobox

A total body, at home, workout solution!

Use jump training, or "plyos," to exert maximum force in short, high intensity, bursts. Commercial quality, non-warping construction. Supports up to 350 lbs. Fast assembly. Includes training DVD and exercise book.

- X54319 12" Plyobox..... \$59.99 ea.
- X54320 18" Plyobox..... 79.99 ea.
- X54321 24" Plyobox..... 99.99 ea.
- X54322 3 Box Set (12", 18", 24")..... 199.99 set



XTREME MONKEY

3 in 1 Wood Plyo Box

A 20", 24" and 30" tall plyo box all in one!

Crafted from premium, non-warping hardwood that can support up to 350 lbs.; and has machine edges for exact fit. Integral part of CrossFit and MMA training sessions. Pre-drilled pocket joints with no visible screws. Takes only a few minutes to assemble. Weighs 64 lbs.

54213..... \$144.99 ea.

#1 SELLER

POWERFIT™ Plyometric Training Platforms

Improves leg power, speed and strength!

Each box is made of 1" steel tubing and 15 gauge steel with .75" plywood with .125" slip resistant rubber padding. Steel reinforced wide frame keeps platforms stable. Platforms nest for storage.



SIZE	EACH	SIZE	EACH
6"	X52540 \$69.99 ea.	24"	X52543 \$113.99 ea.
12"	X52541 89.99 ea.	30"	X52544 136.99 ea.
18"	X52542 99.99 ea.	1 of each size	X52545 439.99 set

XTREME MONKEY

Soft Impact Plyo Boxes

Stack any combination together for desired height!

Set includes 6", 12", and 18" foam boxes. Made from high density foam and covered with 18 oz. vinyl. The bottoms and tops are 30 oz. non-skid vinyl. Each box has a handle for easy repositioning and Velcro strips for stability when stacking. All boxes measures 30" x 36". Ships by truck.



54212 3 Box Set **FREE SHIPPING**..... \$718.99 set



Vulcan Soft Impact Plyo Boxes

Firm, yet cushioned landing helps protect the joints!

Blocks are made from high density foam with a durable vinyl cover. Boxes are secured for stacking with industrial strength Velcro® and have two reinforced handles for portability. Boxes measure 36" x 30".

T16975 Full Box Set- 6", 12", 18" & 24": Ships by Truck..... 1,082.00 set



Body-Solid Soft Sided Plyo Box

Safely push workouts to the next level!

Solid and stable with durable stitched vinyl upholstery and foam interior. Resists compression. Flip and turn for heights of 20", 24" and 30" tall.

54211 **FREE SHIPPING**..... \$287.99 ea.

AGILITY

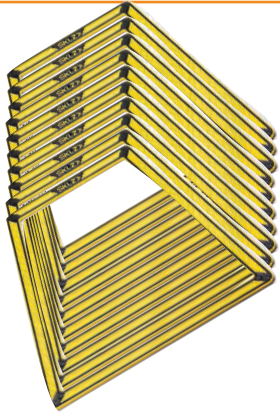

SKLZ Agility Trainer Pro

Sports aren't linear; neither should your training be. Designed for curvilinear and customizable training patterns to train footwork in game like situations. Use on any surface, including grass, tracks and courts. Set includes 10 trapezoids with carry handle.

16978 \$89.99 set

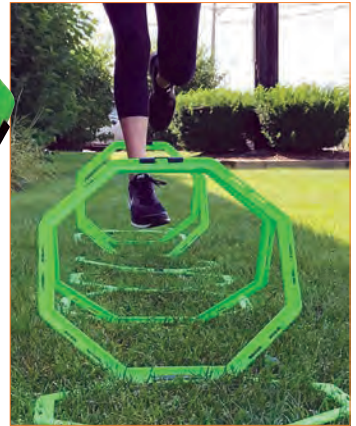

SPORTS HEALTH Octa-Rings

Connecting octagons for creating speed patterns! Rings snap together to create a variety of designs. Each ring measures 16.5" with a low profile .25" height. Set includes 12 octagons and can create a straight ladder 16' long. Includes carry bag.

54196 \$32.99 **SALE \$24.97 set**



Rubber Spot Sets

Colored Poly Spots at an affordable price. Flat 9" or 12" rubber discs for indoors or out. Sold in a set of six, one of each color: red, green, blue, yellow, orange and purple.

21026 SET OF 6 9" size \$13.99 **SALE \$11.97 set**
 21059 SET OF 6 12" size 28.99 **SALE 24.97 set**

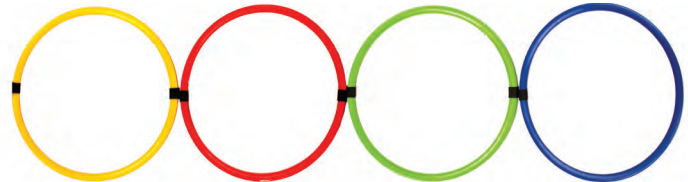

Speed Ring Ladder

Create patterns that stay in place! Set includes 12 plastic hoops measuring 17.5" in diameter. Nylon web strapping loops each ring and are double stitched for strength so the ladder lays flat. Includes carry bag. Measures 17.5"L x 17.5"W.

13104 \$15.99 set



Half Cone Class Pack

36 half cones and a carrying rack. Six of each color: red, yellow, green, blue, purple and orange. Wire Cone carrier is sold separately.
 21025 Half Cone Class Pack \$29.99 **SALE \$23.97 set**
 21036 Half Cone Carrier-only 3.59 ea.



SPORTS HEALTH Flat Hoops

Create your own technical foot patterns! Use indoors or outside. Made from one piece molded plastic. Sold in a dozen set, 3 of each color: red, yellow, green and blue. Includes storage bag.

14004 16" set \$21.99 **SALE \$16.97 dz.**



SPORTS HEALTH 3" Reaction Ball

Test your speed, agility and more! This soft rubber ball improves hand-eye coordination and reaction time. Use solo on hard surfaces or walls or in a team setting. Excellent tool for baseball, softball and lacrosse drills.

10126 SET OF 6 \$21.99 **SALE \$17.97 set**



SPORTS HEALTH 14" Jumbo Reaction Ball

The ball with the unpredictable bounce! Six-sided high-bounce rubber design causes the ball to leap and hop randomly. Sharpens depth perception while making training fun and effective. Great for soccer and football drills.

10590 SET OF 6 \$59.99 **SALE \$49.97 set**
 10598 Assorted Colors 9.99 set

AGILITY



Smart Modular Agility Ladder™

Unlimited options for drills and exercises.

Snap ladders together for desired length and connect rungs together to create the desired width! Create various patterns from double/triple lane ladders to obstacles, zig zag patterns and a full grid. Ladder features two 7.5' segments that snap together for a total ladder length of 15'. Rungs measure 17.5" wide and can clip anywhere along the nylon web straps. The Smart Organizer simplifies gathering and releasing ladder rungs preventing tangling and knotting. Includes handle for easy transport.

- 16983 Smart Modular Agility Ladder™\$59.00 ea.
- 16984 Smart Ladder 4 Pack..... 236.00 pk.

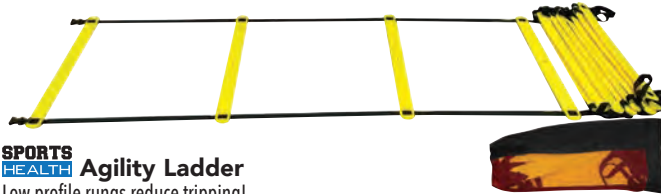

SPORTS HEALTH Agility Ladder

Low profile rungs reduce tripping!

Measures 22' long with 20" wide plastic rungs attached to web strap sides. Includes storage handle and carry bag.

- 13131 Single Ladder.....\$32.99 SALE \$25.97 ea.
- 66497 Ladder 4 Pack..... 103.88 SALE 99.97 pk.



SPORTS HEALTH Indoor Agility Ladder

Anchored with covered iron rods to stay in place on gym floors!

Shift and slide resistant, will not mar floors.

Ladder has 11 rungs, measures 15'L x 18"W.

- 13113..... \$47.99 SALE \$39.97 ea.



SPRI Rollout Ladder

Just roll out and go!

Made from durable non-skid recycled rubber that lies flat when unrolled. Large ladder area is ideal for a variety of users. Measures 15'L x 16"W x 1/2" thick. Weighs 11 lbs.

- X53907 \$78.99 ea.

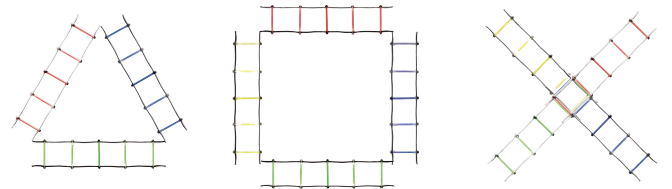

SPORTS HEALTH Colored Agility Ladder 4 Pack

Creatively improve agility and coordination!

Four sections of 6.5' colored ladders can be set up in endless formations for a wide variety of exciting drills. The colored sections snap together with connectors to form a 26' long complete ladder. Plastic rungs are 20" wide and spaced 18" apart. Rungs are fixed to prevent slipping.

- 13123 Colored Agility Ladder 4 Pack- 4 sections\$47.99 SALE \$39.97 ea.
- 66498 Colored Agility Ladder Quad Pack- 16 sections 191.00 SALE 139.97 ea.

Agility Dot Mat

Tests quickness, balance, agility and coordination!

Use indoor or out for bounding/hopping drills, jump rope variations and more. Non-slip, .125" thick synthetic mat rolls for storage. Measures 40"W x 48"L.

- X52357..... \$44.99 ea.



AGILITY



Body-Solid

Weight Sled

Multiple handles make pushing and pulling easy and effective.

Removable posts allow workout customization. Center weight horn for storage and additional resistance with attachment anchors for ropes, lifting bands and more. Measures 50"L x 31"W x 40"H; weighs 68 lbs.

16985 \$260.00 ea.



PowerMax®
Push/Pull Sled

Space saving! Less than 7" high when folded!

Features adjustable width push posts, multiple push/pull options and folds for storage. Frame is constructed from 11 gauge steel with powder coat finish. Measures 24"W x 35"L x 35"H with upright post. Sled includes harness and 3" wide hook and loop closure belt that's adjustable up to 42" waist.

X53659 Sled with Belt & Harness \$429.99 **SALE \$409.97 ea.**



PowerMax®
Tire Tether

Can be used to drag tires of different sizes for varied workouts!

Larger tires work strength while smaller tires work speed. Vary the time and distance of pulling sets. Includes nylon strap and hardware to attach tire (not included), 3" wide hook and loop closure belt adjustable to 42" waist, carry bag and instructions.

53247 \$59.99 ea. **SALE \$54.97 ea.**



PowerFit™ Speed Sled

Built tough to endure hard workouts!

Easy to assemble and constructed of steel with a powder coat finish with 6.5" high Olympic post. Includes adjustable shoulder harness, 80" long leads and carry bag. Sled measures 21.5"L x 13.5"W; weighs 9 lbs.

16575 \$69.99 ea. **SALE \$59.97 ea.**

WEIGHTED TRAINING BALLS



Weighted Training Softball Set

One of the best ways to improve pitching velocity. Use as part of a strengthening and conditioning program to help lessen the risk of injury and improve pitching skills. Features: Color coded weight system, rubber and cork centers, nylon carrying case. Weighted from 9-12 oz. 12 inches, set of 4.

17385 \$45.99 set



NEW

Weighted Training Baseball Set

Same feel as a regular baseball. Use weighted baseballs in training programs to enhance throwing mechanics, arm speed, and arm strength, resulting in enhanced pitch velocity. Features: leather cover with rubber & cork core, color coded weights, nylon carrying case. Weighted from 9-12 oz. 9 inches, set of 4.

17384 \$28.99 set



NEW

Weighted Football Trainer

Excellent for increasing arm strength. Aids in developing muscle memory, improved ball retention skills and is perfect for running drills or warmups. Intermediate size. Choose 2 or 3 lbs.

17386 2 lbs. \$19.99 ea.

17387 3 lbs. 22.99 ea.

AGILITY

XTREME MONKEY VPower Chute

Allows both resistance and overspeed training without a partner.

Improves 2 key elements of speed-stride length and frequency. Chute opens while running for resistance. Velcro belt allows for mid-stride release during sprint for overspeed effect. This increases speed, explosiveness and acceleration. The built in mesh panels eliminate the tangling of strings found on other chutes. Constructed of all weather tear resistant fabric. Adjustable belt fits 20" to 42" waist.



16986..... \$60.99 ea.

SKLZ Speed Chute

Improves stride length and frequency.

Tangle free mesh pre-canopy connects to the nylon chute with heavy duty double stitched seams. The 54" chute provides 15-30 lbs. resistance depending on speed. The 360° rotating belt has a motion ring for ease of movement. One size fits most. Includes a carry bag.



53909..... \$26.99 ea.

SPORTS HEALTH Speed Chute

Increase leg strength and stride length!

Tangle free pre-canopy connects to the nylon chute to force open chute and provide drag. The 46" chute provides 15-25 lbs. resistance. Web strap belt with neoprene padding measures 48" long. Velcro® belt closure. Includes carry bag.

54202..... \$26.99 **SALE \$17.97 ea.**
16719 3 Chute Pack..... 80.90 **SALE \$52.97 pk.**



SPORTS HEALTH Station Pack

Everything needed to keep groups moving!

The book provides 6 week sport specific training programs or you can create your own. Items included are the most often used in the book.

- Pack includes:
- 6 ea. 52517 6" Hurdles
 - 2 ea. 13123 SPH Colored Agility Ladder 4 Pk
 - 1 ea. 10126 3" Reaction Ball
 - 1 ea. 54202 Speed Chute
 - 6 ea. 21048 9" Plastic Cones
 - 1 ea. 52550 Speed Harness
 - 1 ea. 38090 Speed, Agility and Quickness Book & DVD

66499..... \$189.99 pk.



SPORTS HEALTH Quick Release Training System

An essential tool for resistance and over-speed training.

This unit is made with two 108" straps, connected to an adjustable 2" wide belt, via a durable quick release hook. The trainer holds the athlete back with the black strap and uses the red strap to quickly set the athlete free.

17261..... \$19.99 ea.



**INCREASE
SPEED
AND
POWER**

SPORTS HEALTH Agility Pack

Everything needed for increasing speed and power.

- Includes:
- 2 sets 54196 Sports Health Octa-Rings
 - 1 each 16575 Sports Health Speed Sled
 - 2 each 13131 Sports Health Agility Ladder
 - 1 each 16573 Sports Health Versatile Trainer
 - 2 each 54202 Sports Health Speed Chute
 - 1 each 54204 Sports Health Overspeed Trainer
 - 2 sets 16720 Sports Health Nexus Hurdles set of 6
 - 1 each 54207 Sports Health Hoop Holder
 - 2 each 16579 Sports Health RollerBag

16721..... \$533.90 pk. **SALE \$499.97 pk.**

AGILITY



SKLZ Recoil 360™

Alternate between resistance and assistance!

Build strength and conditioning for sprinting, leaping, shuffling or change of direction. Work with a partner or attach the leash to a stationary object. Includes an adjustable belt with free motion ring that allows movement in any direction, an 8' flexi-cord that safely stretches up to 20', a safety handle and storage bag.

53913 \$53.99 ea.



SPORTS HEALTH Overspeed Trainer

Build explosive leg power!

Set includes two web strap 48" long belts with neoprene padding, a 7' long covered stretch strap and carry bag.

54204 \$39.99 SALE \$29.97 ea.



SPORTS HEALTH Evasion Belt

Increase agility, speed, power and coordination!

Players wear a waist belt that is connected to a belt with a Velcro® tear away middle. A player "wins" when they evade and break their connection to their opponent. Waist belts measure 44" with a snap buckle closure. The connecting belt measures 33" with a 60" total clearance between players. All belts are made from web strapping. Includes 4 Velcro® to use on belts as an optional challenge. Includes carry bag.

54201 \$11.99 SALE \$7.97 set



4 Way Tug Of War

A classic Gladiator game!

Four players going in four opposite directions, trying to be the first to grab the ball from their corner. A demanding, intense, but fun physical challenge. Set includes: 1- 4 way harness, 4 belts, 4 balls, 4 cones, 8 carabineers and carry bag.

20054 \$169.99 set



SPORTS HEALTH Speed Harness

Develop maximum leg drive for top acceleration!

Ideal for short and lateral sprints with the partner controlling the resistance level. Includes a one size fits all shoulder harness, a 10' nylon strap with 2 large D rings and foam covered handle with carry bag.

52550 \$34.99 SALE \$28.97 ea.



SPORTS HEALTH Power Builder

Battle for position while maintaining balance!

Includes 2 nylon web strap shoulder harnesses with D-ring for back to back connecting with 9' long web strap belt with carabineers on ends. Includes carry bag.

54203 \$39.99 SALE \$29.97 set



AGILITY

QUICKLY AND EASILY ANCHORS TO FOOT



SPORTS HEALTH High Jump Trainer

A simple way to perform dynamic plyometric training. Resistance increases proportionately to the rate of acceleration of each jump. Anchor the cord ends and begin. Includes two 60" covered latex tubes, 2" wide hook and loop closure 42" long adjustable belt, carry bag and instructions.

16567 \$36.99 ea. **SALE \$29.97 ea.**



SPORTS HEALTH Versatile Trainer

Total body workout!
Covered tubing provides resistance against forward motion of the arms and legs. Improves first steps and take off power. Partner stands behind to anchor or can also slowly jog for running resistance. Padded adjustable nylon straps attach to legs and arms. Includes carry bag.

16573 \$48.99 ea. **SALE \$39.97 ea.**



SPORTS HEALTH Agility Training Gear

Build your own custom resistance workout trainer! Choose from individual components to suit your speed and conditioning needs.

- A: Universal Shoulder Harness - 2" nylon webbing, padded shoulder straps, and adjustable velcro waist belt. 17254 A: \$15.99 ea.
- B: Universal Waist Harness - 2" nylon webbing, neoprene padding, 2 attachment rings, heavy-duty buckle. 17258 B: 12.99 ea.
- C: 10' Covered Resistance Tube - Strong webbed nylon cloth over durable rubber tube. 2 attached carabiner clips. 17259 C: 19.99 ea.
- D: 10' Tow Rope - High strength 1" nylon webbing with 2 attached carabiner clips. 17260 D: 9.99 ea.



XTREME MONKEY Multi-Purpose Harness

Used by professional teams!
Adjustable cross style for comfort and excellent fit. Padded shoulders and front belt closure. Includes nylon web pull cord with carabiners. 7' leash included.

54210 \$41.99 ea.



SPORTS HEALTH Dual Over Speed Trainer

A versatile tool for training alone or with partners! Excellent for increasing power, strength and agility. Designed with two 10' long nylon covered latex tubes attached to a padded harness. Snap hooks on the ends enable unit to be secured to a fixed object or may be held by up to 2 partners. Waist belt is 2" wide and adjustable to 55".

17263 \$68.99 ea.



SPORTS HEALTH Solo Over Speed Trainer

An ideal tool for training without a partner. Helps athletes train to maximize strength, speed, and vertical jump. Train with a partner or anchor to a sturdy object with the strong nylon strap. 10' long cloth covered latex tube. Adjustable harness.

17262 \$34.99 ea.

HURDLES



SPORTS HEALTH Nexus Hurdles

Adjusts from 6" to 9" to 12" simply by lifting the bar!
Folds flat for storage. Made from molded plastic.

16720 Set of 6 Hurdles	\$65.99	SALE \$39.97 set
17200 Set of 6 Hurdles with carry Strap	70.99	SALE 43.97 set



SPORTS HEALTH Six Color Training Hurdle Set

Great for defining stations or lanes!
These hurdles are made from sturdy PVC tubing.
Each size available in a set of 6, one of each color.

52517 SET OF 6 6"	\$39.99	SALE \$31.97 set
16998 SET OF 6 6" hurdles with carry strap	56.99	SALE 35.97 set
52518 SET OF 6 12"	49.99	SALE 39.97 set
16999 SET OF 6 12" hurdles with carry strap	64.99	SALE 43.97 set



SPORTS HEALTH Training Hurdles

Change the way you train!
Increase speed, higher knee lift and gain agility skills with these sturdy .75" O.D. PVC hurdles. Orange only.

SIZE	SET OF 6	SET OF 6 W/STRAP
6"	42187 \$39.99 SALE \$29.97 set	16994 \$47.99 SALE \$33.97 set
12"	42188 49.99 SALE 34.97 set	16995 57.99 SALE 38.97 set
18"	42189 74.99 SALE 56.97 set	16996 82.99 SALE 60.97 set
24"	42190 81.99 SALE 61.97 set	16997 89.99 SALE 65.97 set



SKLZ Speed Hurdle Pro

Quick adjusting heights for varying training drills.
Hurdles feature a highly durable base, low profile design for feet of all sizes and innovative bounce back construction when stepped on. Adjusts from 6" to 9" to 12" high with one button. Folds for storage. Set of 6 hurdles and carry case.

16993 Set of 6 Hurdles with case	\$62.99 set
----------------------------------	-------------



Smart Hurdles™

Combine lateral, vertical and forward movement training!
Versatile hurdles for use in agility or over/under training. Each hurdle is constructed from high impact ABS plastic with a sturdy 3 point base and folding support leg for easy storage. All sets include carry handle.

42103 Set of 6 6" Hurdles	\$99.00 set
42104 Set of 3 12" Hurdles	109.00 set
42105 Set of 3 12"-18" Adjustable Hurdles	169.00 set
42106 Set of 3 21"-36" Adjustable Hurdles	199.00 set
42107 Set of 3 27"-42" Adjustable Hurdles	209.00 set



SKLZ 6X Hurdles

Lightweight, durable and featuring bounce back construction.
Use for multi-directional speed, agility and plyometric training. One piece twist design will stand up to the biggest beatings and heaviest of athletes. 6" high, sold in a set of 6 hurdles.

16991 Set of 6 Hurdles	\$44.99 set
16992 Set of 6 Hurdles with Carry Strap	48.99 set

HURDLES

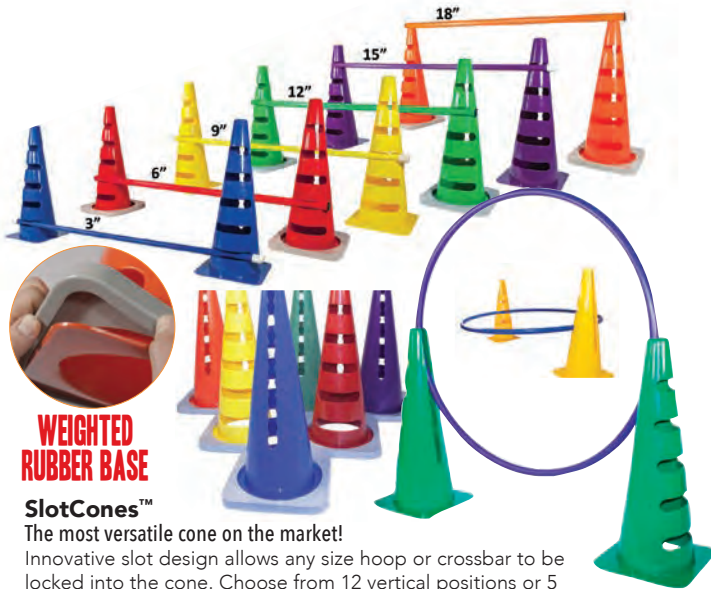

WEIGHTED RUBBER BASE

SlotCones™

The most versatile cone on the market!

Innovative slot design allows any size hoop or crossbar to be locked into the cone. Choose from 12 vertical positions or 5 horizontal (from 3" to 18" high). SlotCones™ are heavier than and twice as strong as a typical cone. Add optional weighted rubber bases for enhanced stability. Lock-In crossbars fit snugly into the horizontal slots. Cones: 18.5"H x 8"W. Crossbars: 40" long.

- 21217 SET OF 6 SlotCones™ \$48.99 set
- 21218 SET OF 6 Lock-In Crossbars 40"L 34.99 set
- 21219 Weighted Rubber Base 8.75"L x 8.75"W 7.99 ea.
- 66773 SlotCones Activity Kit - 6 ea. of SlotCones™ & 6 Lock-In Crossbars) 79.99 set

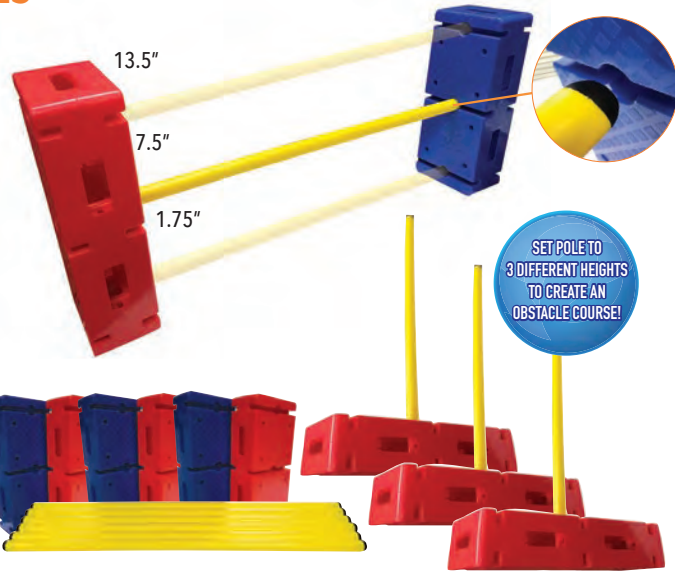

ZONE Block & Pole Pack

Create hurdles and obstacles for your classes.

Blocks measure 14.25"L x 5.87"W x 3.75"H with three openings for poles. Set hurdle heights at 1.75", 7.5" or 13.5" high. Blocks are made from sturdy two piece molded plastic. Sold as a pair, one red and one blue. Pack includes 6 blocks and 6 poles.

- 17142 6 Block & 6 Pole Pack \$69.95 SALE \$54.97 pk.
- 59107 Blocks Only 17.99 SALE 14.97 pr.
- 17141 28" Plastic Poles Only- 3 per set 7.99 set

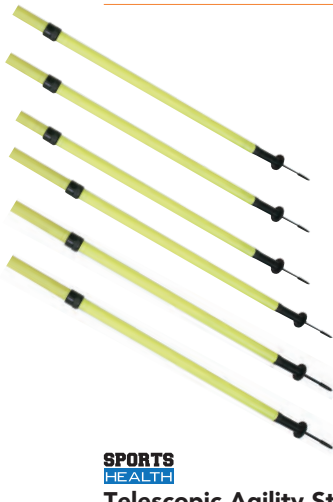

SPORTS HEALTH

Telescopic Agility Sticks

Spring loaded spike for safety.

The 1.375" diameter plastic pole telescopes to a maximum height of 64".

- 54208 Set of 6 \$71.90 SALE \$44.97 set



ZONE Cone Set

Slotted on top; connecting holes in body!

A multi-purpose cone that allows you to make hurdles or display instruction sheets. 12" plastic cone with 12 holes. Set includes 6 cones in 6 colors and 3 yellow 28" plastic connecting poles.

- 21195 TheZone Cone Kit- 6 cones & 3 poles \$39.90 SALE \$35.97 kit
- 21198 SET OF 6 12" TheZone-Slotted Cones 31.99 SALE 25.97 set
- 17141 28" Yellow Plastic Poles-Set of 3 7.99 set



ZONE

Hurdle Carry Strap

Easily fits over 6 hurdles or 12 hoops!

Simple overlap design with Velcro® closure. Made from nylon with web strap handle. 7.75" long. Hurdles not included.

- 54207 \$6.99 ea. SALE \$4.97 ea.



ZONE

Padded Hurdle Carry Strap

Holds up to 12 hurdles or hoops!

Adjustable nylon strap with padded shoulder and hook and loop closure. Hurdles not included.

- 16570 \$9.99 ea. SALE \$6.97 ea.

STRETCHING



18" Massage Bar
Awaken tired muscles!

Ideal for before and after workouts!
Rubberized bar has multi-directional massage patterns to deliver surface and deep tissue massage. Includes instructional booklet.

53430 \$24.99 ea.



Pro-Tec 22" Roller Massager
Effective tool for Myofascial release!

Rounded grip ends provide precision trigger point release. Includes instructions for 20 massage and trigger point release techniques. 22" long.

54324 \$31.99 ea.

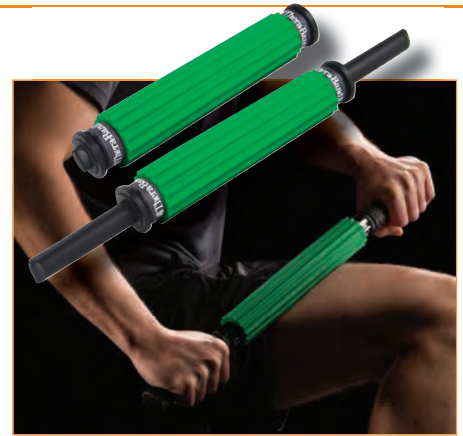

TheraBand Roller Massager

Increase blood flow and circulation in targeted areas!
Innovative tool ideal for Myofascial release and deep tissue massage. Helps to increase muscle flexibility and range of motion.

54325 Standard 21" L \$26.99 ea.

54326 Portable retracts to 12" L 28.99 ea.



Trigger Ball2

Targets sore muscles for pain relief.
Relieves knots, trigger points and muscle soreness. Dual cords help reach your back, shoulders, glutes, legs and more in need of deep-tissue massage. No-slip rubber surface. Includes Trigger Ball2 & therapy poster.

54346 \$22.99 ea.



Body Sport Stretch Strap

Unique lettering system gauges flexibility progress!
The strap helps induce a more effective, dynamic stretch. Use to deepen yoga poses, athletic training or pre-workout stretches.

16732 \$15.99 ea.



SPRI XerStretch® Strap

Use for assisted stretching of all major upper and lower body muscles.
The 1" wide nylon strap includes loops at each end for hands and a center loop to keep the foot securely in place.

53899 \$9.59 ea.



5" Massage Ball

Reaches deep muscle tissue to relieve pain and soreness.
Made of dense, lightweight foam with a solid core, the 5" massage ball targets virtually all muscle groups. The soft textured surface keeps it in place. Simply press and roll. Convenient and portable.

54347 \$18.99 ea.



Calf Stretcher

Improves flexibility!
Rocking motion provides a dynamic stretch to the lower leg. Ideal for pain associated with plantar fasciitis. Made of PVC with a non-slip bottom. Fits up to adult size 13 shoe.

16310 \$25.99 ea.



Stretching Posters

Great for warm ups and improving flexibility!
Large photos with concise instructions clearly explaining proper form. Posters are laminated and measure 24"W x 36"L.

52862 Upper Body Poster- 14 stretches \$23.99 ea.

52863 Lower Body Poster- 13 stretches 23.99 ea.

RECOVERY



GoFit Guide Roller

Recovery routine printed directly on the foam roller!
 Made of a super high-density foam designed for deep tissue massage and heavy use. Beneficial for muscle recovery and regeneration. Improves alignment and hip mobility. 12 printed exercises. 24" L x 6" D.
X17300 \$34.99 ea.



GoFit Pro Deep Tissue Accupoint Massage Roller

Reaches deep muscle tissue with acupressure therapy nodules!
 Massage pressure is distributed across nodules maintaining stability for heavy use. Helps blood to quickly flood the muscles to speed up recovery. Made of closed cell lightweight dense foam. Includes manual.
 13" L x 5.75" D.
X17301 \$24.99 ea.



ELEMENT FITNESS 13" CORE Foam Roller

Great for stretching, self-massage, body support, and stability exercises.
 Includes a multiple pattern design to engage different muscle groups. Features a sturdy 4" hollow core with a foam rubber layer. Built to last.
X16309 13" L x 5.5" diameter \$35.99 ea.



ELEMENT FITNESS EVA Foam Roller

Hex shaped nodules for added comfort!
 A premium EVA foam roller with raised texture for effective massage and loosening of tight muscles. Ideal for Pilates workouts as well.
X16307 18" L x 6" diameter \$27.99 ea.
X16308 36" L x 6" diameter 44.99 ea.



Pro-Tec Foam Rollers
 Ideal for promoting recovery, flexibility and stretching.
 Alleviates muscle and soft tissue tightness of the upper and lower back, legs, upper arms and much more. Stretches muscles and tendons, soothes tight fascia while increasing blood flow and circulation to the soft tissues. Choose the roller that fits your needs:

Item	Color	Size	Model	Firmness	Price
SH61956	A. Gold	4" x 12"	Travel	High Density	\$11.99 ea.
SH61957	B. Blue	6" x 18"	Regular	High Density	20.99 ea.
SH61958	C. Pink	6" x 18"	Regular	High Density	20.99 ea.
SH61960	D. Blue	6" x 35"	Full Body	High Density	22.99 ea.
SH61961	E. Blue	6" x 12"	Half Round, Balance	High Density	13.99 ea.
SH62177	F. Black	6" x 36"	Heavy Support, 300 lbs. +	Extra Firm/Dense	40.99 ea.

X66814 6 Roller Pack- 2(B) - 2(C) - 1(D) - 1(F) from above \$144.99 Pk.

Foam Roller Storage Rack

Keep rollers stored neatly and out of the way.
 Rack comes with casters and holds 12 6" diameter foam rollers. Dimensions: 35" x 21" x 36".
X16766 \$149.99 ea.



YOGA



SPORTS HEALTH Deluxe .25" Yoga Mat

Longer and thicker for ultimate comfort!

Mat is 74"L x 24"W and a full .25" thick with a textured, non-slip surface. Made of highly durable closed cell vinyl foam with embedded fabric mesh, the mat will perform at a high level for many years. Lead and latex free.

- 52039 Deluxe Yoga Mat \$21.99 **SALE \$17.97 ea.**
- 66178 Basic 12 Pack: 12 Deluxe Mats & 2 Bags..... 299.99 **SALE 249.97 pk.**
- 66179 Advanced 12 Pack: 12 Deluxe Mats, 12 blocks, & 2 Bags..... 399.99 **SALE 329.97 pk.**



SPORTS HEALTH .125" Basic Yoga Mat

This is the classic sticky yoga mat.

It provides the traction and firm surface that you need to perform at your very best. Made of highly durable closed cell vinyl foam with embedded fabric mesh, the mat will withstand heavy use. Lead and latex free. Measures 68"L x 24"W x .125" thick.

- 29027 .125" Yoga Mat \$14.99 **SALE \$12.97 ea.**
- 66176 Basic 12 Pack: 12 Mats & 2 Bags..... 246.99 **SALE 197.97 pk.**
- 66177 Advanced 12 Pack: 12 Mats, 12 Blocks & 2 Bags..... 342.99 **SALE 292.97 pk.**



SPORTS HEALTH Yoga Block & Strap

Lightweight, durable and economical.

Use for hand and back support, easy to manipulate in any position. Firm

foam covered block measures 3" x 6" x 9".

Strap is made 100% cotton with an easy loop style buckle. Use to increase flexibility and allows you to grasp and reach limbs to increase stretching.

- 52040 Yoga Block \$5.99 ea.
- 52041 Yoga Strap 5.79 ea.
- 54031 Yoga Block and Strap 10 Pack: 10 of each..... 117.80 **SALE 89.97 pk.**



Yoga Cards

Use the cards for a yoga session, a warm up or have the class create their own routines!

Organized by color for easy, intermediate or challenging poses, this set of 16 cards have a photo on the front of a child in a pose and on the reverse side are illustrated instructions. Set includes 16 heavy duty 8.5"W x 11"L cards with instructions, sample routines and activity ideas. Ages 4 and up.

- 52886 \$24.99 set

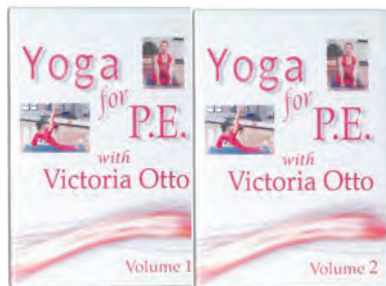

Yoga for P.E.
Teaches the basics of yoga.

Part 1 introduces 20 poses. The instructor is able to click on each individual pose or view them all together. Part 2 combines all of the poses for a traditional 25 minute workout.

- 39185 Volume 1 96 minutes \$25.99 ea.
- 39193 Volume 2 40 minutes 25.99 ea.



HotSpots®

Tear resistant thermoplastic spots with membrane printed graphics!

Won't scuff or tear and the anti-slip material keeps the spots where you put them! Sets display 12 classic poses and movements for Yoga and Pilates. Includes an activity guide. Spots measure 8.5" in diameter.

- 21134 Pilates Set \$44.99 set
- 21135 Yoga Set 44.99 set

YOGA



Aeromat™ .125" Yoga Mat

With built in mesh for minimum stretch!
 Made from Phthalates free PVC closed cell foam with a sticky surface.
 Measures 68"L x 24"W x .125" thick.

- X54112 Blue \$19.99 ea.
- X54113 Purple..... 19.99 ea.
- 66510 Basic 12 Mat Class Pack: 12 Blue Mats & Bag 269.99 pk.
- 66511 Advanced 12 Mat Class Pack: 12 Purple Mats, 12 Blocks & 2 Bags 339.99 pk.



NEW

Wai Lana School Yoga Kit
 Perfect for all your Little Yogis™.

Each kit comes with 12 kid-sized yoga mats printed with fun cartoon patterns. They are free of latex, phthalates, phenols, dioxins and furans. The non-slip surface makes them safe for children. Durable and washable. Measures: 60"L x 24"W x 1/8" thick. Also includes: 12 mat bags, Little Yogis™ DVD (30 min.), Little Yogis™ poster (21 poses), set of fun stickers.
 54349 \$319.99 kit

NEW

GoFit™

Yoga Mat

Excellent non-slip surface ideal for yoga and Pilates.

This mat has a cushioned, airy surface, providing comfort and protection during specific yoga poses or Pilates mat work. Wipes clean with a damp cloth. 68"L x 24"W.



- 54348 Blue \$19.99 ea.
- 54355 Gray 19.99 ea.
- 54356 Pink 19.99 ea.
- 66815 Blue - 12 pack \$229.99 pk.
- 66820 Gray - 12 pack 229.99 pk.
- 66821 Pink - 12 pack 229.99 pk.

NEW

Aeromat™ Elite .25" Yoga Mat

Grippy surface is great for both yoga and Pilates practice.

Built-in mesh offers anti-stretch capability. Comes with carrying harness. Made with a PVC material, free of latex and phthalates. Measures 72"L x 24"W x .25" thick. Packs include 12 lightweight yoga blocks that measure 3" x 6" x 9".

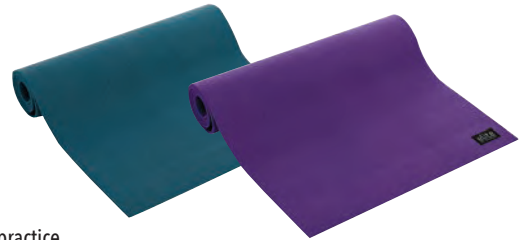

- X54359 Teal..... \$23.99 ea.
- X54360 Pastel Purple..... 23.99 ea.
- X66822 Teal Class Pack: 12 Mats & 12 Blocks..... 274.99 pk.
- X66823 Purple Class Pack: 12 Mats & 12 Blocks..... 274.99 pk.



Wall Mount Adjustable Mat Rack

Hangers adjust from 15" to 21" wide. Designed to hold up to 10 exercise or yoga mats with grommets. Maximum weight capacity is 66 lbs. Includes hardware.

X16773 \$29.99 ea.



Adjustable Mat Rack

Adjusts to 24" maximum width. For hanging grommetted exercise or yoga mats up to 74" long. Steel construction with casters for transport. Dual side hangers hold up to 10 mats. Some assembly required. Measures 78" x 24".

X16770 \$199.99 ea.



Small Portable Mat Rack

A smaller storage solution for hard or soft yoga mats. Steel construction with non-marking casters. Rack measures 44"L x 34"W x 27"H and can store up to 40- 1/2" thick mats or up to 25- 3/4" thick mats.

X16771 \$183.99 ea.



Large Portable Mat Rack

A larger storage solution for hard or soft yoga mats. Steel construction with non-marking casters. Rack measures 39"L x 47"W x 28 3/4"H and can hold up to 100- 1/8" thick mats or 50- 1/4" thick mats.

X16772 \$203.99 ea.

MATS



.5" thick closed cell foam

BEST BUY

AVAILABLE IN A COLORED SET OF 6



SPORTS HEALTH
Foam Exercise Mat
Super soft foam mat.

Our best value- soft material can be rolled or stacked flat for storage. Memory foam allows them to lay flat for a comfortable workout. Single blue mat is made from a dense .5 thick foam and is available in a Class Pack of 30 mats. The Set of 6 mats are 3/8" thick.

- X39059 Blue Mat only- measures 48"L x 24"W..... \$17.99 **SALE \$14.97 ea.**
- X29147 Class Pack- 30 mats 539.70 **SALE 429.97 pk.**
- 16774 SETOF6 48"L x 24"W..... 138.99 set



polyethylene foam

SPORTS HEALTH
Flat Exercise Mat
Premium lightweight washable mat.

Easy to clean workout mat is constructed of high density PE foam, with firm top and bottom layers that repels moisture. Easily wipes clean. Convenient handle cutout. Color: blue. Measures 48"L x 24"W x .75" thick.

- X29153 Single Mat \$15.99 ea.
- X29154 30 ct. Class Pack 479.70 **SALE 449.97 pk.**



SPRI
Exercise Mats

Lightweight yet resilient!

This durable 3/4" thick poly foam mat is perfect for any floor exercise program. Easy to roll up with convenient carry handle. Mats measure 48"L x 20"W x .5" thick.

- X29527 Black..... \$21.99 ea. X29531 Black Mat Class Pack- 30 mats \$569.99 pk.
- X29528 Blue 21.99 ea. X29532 Blue Mat Class Pack- 30 mats... 569.99 pk.

STORE MATS EASILY

Aeromat™ Workout Mats WITH OPTIONAL WALL RACK!
Comfortable and extremely durable.

Made of easy to clean Phthalate and PVC free closed cell foam. Lightweight, rolls up for storage and is ideal for any floor exercise.

- X29533 Blue 48"L x 20"W x 1/2" Thick..... \$19.99 ea.
- X29534 Red 48"L x 20"W x 1/2" Thick 19.99 ea.
- X29535 Black 48"L x 20"W x 1/2" Thick 19.99 ea.
- X29536 Green 48"L x 20"W x 1/2" Thick 19.99 ea.
- X29537 Green 56"L x 23"W x 1/2" Thick 24.99 ea.
- X29538 Blue 72"L x 23"W x 1/2" Thick..... 29.99 ea.
- 51093 Wall Rack for 20" Wide mats-holds 10 mats 25.99 ea.
- 51094 Wall Rack for 23" Wide mats-holds 10 mats 25.99 ea.



FEATURES
3" LINES ON ONE END
AND 4.5" ON THE OTHER



SPORTS HEALTH
Curl Up Assessment Mats

Raised lines allow users to feel the start and finish points!

Allows students to maintain proper form. Mat is made from 1/2" thick closed cell foam with vinyl cover and glued in lines at both ends. One end features 3" lines the other end measures 4.5". Mat measures 48"L x 24"W.

- 25183 SETOF6 \$179.99 **SALE \$159.97 pk.**
- 25187 Assorted Colors..... 31.99 **SALE 27.97 ea.**



Jasmine Fitness
Padded Exercise Mat

Ideal for yoga, stretching or rehab work. Superb cushioning with closed cell compressed foam provides a non-slip grip. Lightweight and easy to clean and roll up. Includes carry strap. Measures 72"L x 22"W x 5/8" thick.

- X29459 Single Mat..... \$21.99 ea.
- X66816 10 Pack..... 209.99 pk.

MATS



2" Folding Mats

Excellent for stretching and core workouts.

Easy to clean with a non-absorbent cover over high density foam. Heavy duty stitched seams and handle for transport. Folds for storage.

- X29451 4'Lx2'W \$49.99 ea.
- X29452 6'Lx2'W 74.99 ea.
- X29454 6'Lx4'W 124.99 ea.



TROY Trifold Exercise Mat

Compact fold takes up less space and makes it easy to store.

The Trifold's 1.5" thick padding provides comfortable support while its durable vinyl covering is easy to clean. Built-in handles make transport easy. Measures: 72"L x 24"W x 1.5"H. Weights: 8 lbs.

- X54350 Single Mat \$43.99 ea.
- X66817 6 Pack 229.99 pk.



Vinyl Folding Exercise Mat

An excellent economy folding mat.

A basic vinyl mat with three folds and a .625" thick foam center. Measures 46" x 20".

- X29010 \$11.99 ea.



Everlast Folding Exercise Mat

Ideal for core workouts!

Non-absorbent shell with sewn in handle for easy transport. 1 5/8" foam core for support and comfort. Folds for storage. Black. Measures 6'L x 2'W.

- X29557 \$59.99 ea.
- X29558 6 Pack 339.99 pk.



Smart Mat™

Core and stretching exercises printed on both sides!

Durable non-slip nitrile rubber mat with easy to follow exercises and stretches on both sides. Includes grommets for hanging. 6'L x 2'W x 16mm thick. Blue.

- 29443 Blue Smart Mat \$54.99 ea.
- 29444 10 Mat Pack with Rack 599.00 pk.
- 29460 Wall Rack only 116.00 ea.



Guide Mat

Dynamic workout printed directly onto the mat.

Includes 24 warm-up, calisthenics, and recovery exercises. The mat is double-cushioned, closed cell foam with a non-slip surface for extra comfort and protection. Natural rubber & TPE. 72"L x 24"W, 7mm thick.

- 54351 \$32.99 ea.

FITNESS STATIONS



STATION CARDS AVAILABLE IN
 ● BASIC ● ADVANCED ● AEROBIC

SKU	Station Cards	SKU	Station Cards
53275	Basic Fitness #1	53828	Dynamic Flexibility #2
53276	Basic Fitness #2	53829	Balance #1
53277	Advanced Fitness #1	53830	Balance #2
53278	Advanced Fitness #2	53416	Abdominal #1
53279	Aerobic Circuit #1	53417	Abdominal #2
53280	Aerobic Circuit #2	53418	Flexibility #1
53825	Basic Core #1	53419	Flexibility #2
53826	Basic Core #2	53420	Plyometrics #1
53827	Dynamic Flexibility #1	53421	Plyometrics #2
SET OF 6		SET OF 6	

Dr. Curt Hinson's Circuit Training Curriculum

Great stations to use as a workout in a circuit or for warm ups!

Large images show the exercise with printed instructions of the movement. Station cards are laminated and measure approximately 8.5"W x 11.25"H. Pyramids are made from lightweight, durable corrugated plastic with easy slot and tab assembly. Stand 18" high with a 9.75" wide base. Collapsible and fold flat for storage. Think multi-use: as targets, hurdles, goals or more! Station Cards and Pyramids sold separately.

X53999 SET OF 6 Rainbow Pyramid Set \$66.99 set



21138 - Core Exercise 21141 - Medicine Ball 21140 - Exercise Ball 21118 - Calisthenics



21148 - Muscle Group 21137 - Tubing 21171 - Cardio 21139 - Jump Rope

HotSpots™

Wear resistant thermoplastic elastomer spots!

Each spot has a detailed explanation of how to perform drills with supporting graphics that won't scuff or tear! Just spread them out and your stations are set. Includes 12 HotSpots™ and activity guide.

Specify Style Measure 8.5" in diameter \$44.99 ea.



Playout Fitness Station Cards

Bright, colorful cards make fitness easy and fun.

Enlarged visuals let players know their next exercise at a glance. Choose from regular or junior versions. The regular set includes 30 cards – 10 upper, 10 core and 10 lower bodyweight exercises. Each card offers options for easy, medium or hard. The junior set includes 17 cards designed for students ages 2-7. Each card has an exercise along with fun sayings or words of encouragement.

54352 Station Cards 30 Pack \$58.99pk.
 54353 Jr. Station Cards 17 Pack 38.99 pk.

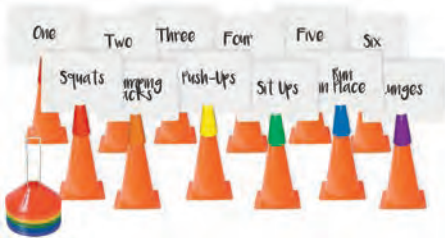

Station Class Pack

Everything needed to create a 12 station circuit!

- 2 sets 21205 6 white boards & 6 holders
- 12 ea. 21027 12" orange plastic cones
- 1 set 21025 36 Half Cone Class pack

21207 \$129.99 SALE \$119.97 pk.



Station Board Holders

Holds station signs or dry erase boards.

Designed with a slotted top to hold signage, the convenient 6" tall holders fit atop most cones.

Create your own signs using the 11" x 8.5" dry erase boards. Sold separately or purchase as a set.

21201 SET OF 6 White Board Holder SALE \$14.97 set
 21202 White Boards Set of 6 SALE 15.97 set
 21205 Pack- 6 White Boards & 6 Holders SALE 35.97 set



3C's HotSpot™ Class Pack

Calisthenics, cardio and core -no equipment needed!

36 spots with activity guides!

Contents:

- 1 set 21118 Calisthenics HotSpots
- 1 set 21171 Cardio HotSpots
- 1 set 21138 Core HotSpots

21208 \$134.90 SALE \$124.97 pk.

FITNESS STATIONS



Vulcan Limitless Timer

Versatile timer with programmable count up/down options.

- Interval timing w/ work and rest times & stopwatch function
- Large 4" digits and loud timer alarm
- Includes AC adapter w/ 15' cord, wall mount brackets and remote
- Remote requires 2 AAA batteries (not included)

48185 28.5"L x 6.25"H x 1.625"D\$259.00 ea.



Cross Timer

With 4" display.

Features a 10-second countdown and can be programmed to count up to or down from a set time. It also has a 20/10 tabata interval programmed in. Will function as a clock and mount to the wall. Includes adapter with cord, instruction manual and remote. Remote requires batteries.

Measures 20"L x 6.5"H x 1.5"D. Weighs 3.8 lbs.

48149\$199.99 SALE \$164.97 ea.

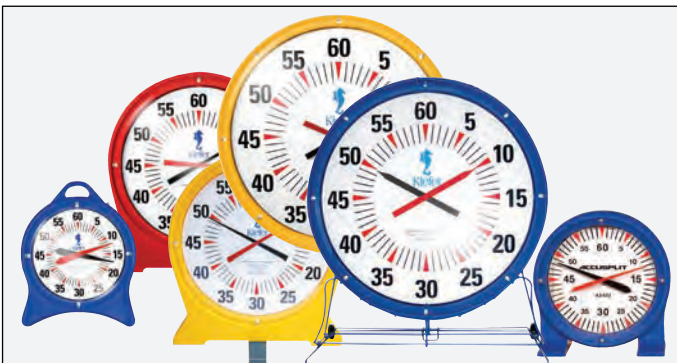

SEE OUR FULL LINE OF KIEFER® AND ACCUSPLIT® PACE CLOCKS

@ palossports.com

Time Tracker® Visual Timer & Clock

Manage time more efficiently!

Features 180° viewing and a large, easy to read LCD display. Alarms from 1 sec to 24 hours. Allows quick programming of 3 colored lights (red, yellow and green) that alert children to time remaining. Can be customized to suit your needs. Measures 8" x 4". Includes 2 LR44 back-up batteries. Requires 4 AAA batteries

16057\$39.99 ea.



Count Up/Down Clock

Includes 8 hour rechargeable battery.

- Counts up/down to 99:59
- Bright LED 4" digits, 12/24 hr. clock
- Built-in control panel with horn
- 120v AC power

48127 13"L x 6"H x 4"W\$229.99 SALE \$199.97 ea.



MegaTimer

Table top, wall mount or take with you on the go!

Features time and date, countdown timer, stopwatch, alarm and temperature. Includes the unique Student and Team Selector buttons to randomly choose students to answer or teams to go first. Includes a Random mode that operates as dice, a spinner or generates random numbers for math problems. Measures 9.5"L x 6.5"H. Requires 6 AA batteries, not included.

48182\$54.99 ea.



Big Digit Timer

Small, approximately 3" x 3" count down timer.

This small timer can easily stand on a table, clip on clothes or attach via magnet. Built in memory, large 3/4" display and loud alarm at "time up". Powered by one AAA battery included.

48025\$19.99 ea.



Tally Counter

Easily keep track of reps, laps and more.

The easy to use tally counter goes up to 9999 with the simple push of a button. Use during fitness testing, training and relay races.

48022\$4.99 ea.



CIRCUIT STATIONS

NEW

Agility Spot Challenge Mat™

Designed for students of all ages and sizes. The Challenge Mat includes an activity guide that walks students through how to perform different routines, hopping from spot to spot. This builds foot speed, and helps improve balance and agility. It also strengthens tendons and muscles in the ankles and knees. Measures 48" L x 36" W. **X17398** \$149.99 ea.

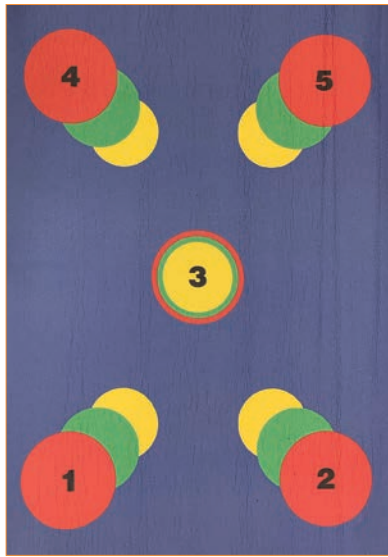

NEW

Burpee Challenge Mat™

A whole-body workout designed around burpee variations. An exceptional addition to any fitness station, the various colored foot and hand sets help guide students through various whole-body routines. The routines range from easy to very difficult and are organized by the included activity guide. Measures 70" L x 48" W. **17399** \$159.99 ea.



Tire Cross Challenge

Works the entire upper body and core! Left and right hand marked in opposing colors show users where to travel around the mat. Variations of basic movements create several levels of difficulty. Multiple users can be on the mat at the same time. Includes progression sheet. Non-slip mat measures 60" in diameter with an 18" diameter middle opening. **X16843** \$124.99 ea.



Snake Cross Challenge™

Work upper body and core while having fun! Students will start in a push-up position with their hands on the first set of hands near the snake's head. They then will move across the length of the snake's body using the handprints as a guide. Great for plank exercises, body positioning changes and pushups. Ideal for multiple users. Non-slip mat measures 10' L x 18" W. **16842** \$155.99 ea.

NEW

Playout: The Game of Fitness

The innovative card game turns working out into fitness fun. The 52 card deck contains 30 bodyweight exercises (upper, lower & core), 10 stretches, 6 WildCard challenges, and 6 MiniGame competitions for variety, adaptability, and fun. Teams compete to earn the most points by completing more difficult challenges. Cards are printed with easy, medium and hard versions of each challenge, along with directions and tips. Deluxe Edition includes large 4" x 6" cards, with dividers, in a hard box. Standard edition includes 2.5" x 3.5" cards and instructions. **54357** Deluxe Edition \$58.99 pk. **54354** Standard Edition \$38.99 pk.



FitDeck™ Exercise Cards

Equipment free workouts! These fitness oriented decks provide simple to use, easy to learn, convenient and fun activities for a variety of ages, skill and exertion levels! For individual, group or station workouts, use as a warm up or complete, total body workout session. 56 card set. **52516** Bodyweight FitDeck™ \$14.99 set **52515** FitDeck™ Jr. \$14.99 set

CIRCUIT STATIONS



ZONE Exer-Dice

11 different exercises- no equipment necessary!

Lunges, push-ups, bicycle, crab kicks, jumping jacks and more. Dice are made from firm foam with a durable vinyl cover. They measure 6.25" high. Sold in a set of 6 or individually in assorted colors.

- 16982 SET OF 6 \$114.99 **SALE \$99.97 set**
- 17146 Individual Exer-Dice Assorted Colors \$21.99 **SALE 18.97 ea.**



ZONE Exer-Dice Packs

Pair up with our 20 sided dice!

Divide classes into 6 color groups for easy warm ups and cool downs! Pack includes 6 Exer-Dice and 6 20 Sided Dice. Exer-Dice Mini pack includes: 1 Exer-Dice and 1 20 Sided Dice in assorted colors.

- 66701 Exer-Dice Pack- 6 of each dice \$173.50 **SALE \$114.97 pk.**
- 66735 Exer-Dice Mini Pack- 1 pair; assorted colors \$24.50 **SALE 21.97 pr.**



Pocket Cubes

Create your own activity cubes!

Use for repetition markers, quick quizzes, station activities, field day and more! These 6" cubes are poly filled with a vinyl covering and have clear, thick pockets that will hold a 5.75"L x 5.25"H piece of paper. Sold in a set of six, one of each color: red, orange, yellow, green, blue and purple.

- 16981 SET OF 6 \$48.99 set



ZONE 20 Sided Dice

More options for number fun!

Made from durable polyurethane with molded in numbers that won't wear down. 6" tall. Set of 6.

- 16161 SET OF 6 \$34.99 set



Muscle Hustle™

A fast moving, muscle matching workout!

Divide class into 3 or 6 groups. Players must determine and find the muscle to be strengthened by the exercise on their Muscle Strip™. Once they find the correct muscle spot, they perform ten repetitions of the exercise.

Ideal for grades K-5. Available in 3 or 6 color sets. Full color and laminated Muscle Cards™ measure 8.5" x 11" and Muscle Strips™ measure 8" x 2".

Muscle Group HotSpots™ sold separately.

- 21154 3 Color Set- 3 Muscle Cards, 54 Muscle Strips and Instructions \$44.99 set
- 21153 6 Color Set- 6 Muscle Cards, 108 Muscle Strips and Instructions \$4.99 set
- 21148 Muscle Group HotSpots™- Set of 12 \$14.79 set

Muscle Group HotSpots™ sold separately.



ZONE Exer-Dice Xtreme

Let the Exer-Dice decide!

Soft sided foam workout dice has 12 sides, each with a different exercise and rep count. Roll options include: burpees, walking lunges, pushups, air squats, tricep dips, planks, Russian twists, wall sits, jumping jacks, crunches and lunges. 6" diameter.

- 16781 Single Dice \$21.99 **SALE \$15.97 ea.**
- 66769 Set of 6 \$131.90 **SALE 109.97 set**

Fitness Dice

Roll your own exercise.

These poly-filled 4" x 4" vinyl covered dice will make exercising more fun. One die has numbers and the other has different exercises. Sold in pairs.



- 15016 \$13.99 **SALE \$10.97 pr.**

CIRCUIT STATIONS

SPORTS HEALTH Ball & Stick Pack

Have your classes keep the beat going! The 25" stability ball has feet to keep the ball from rolling away! Play some music and have your class keep the beat for a great cardio workout. Drumsticks are 16" long wood sticks. Pack includes: 24 balls and 24 pairs of drumsticks.

- 66742 Ball & Stick Pack \$449.99 pk.
- 17230 16" Drumsticks - 6 Pairs. 24.99 pk.



NEW

Terra Core™ Workout System

Designed to be more than just a balance trainer.

The Terra Core™ is designed to work by itself or incorporated with resistance bands, dumbbells, kettlebells, and more to create the most dynamic workout circuits imaginable. The elongated design means you can engage more of your muscle groups. Flip it over to use the built-in handles – close set or wide – for pushups and more. Measures 46" L x 17" W x 10" H. Weighs 28 lbs. Weight capacity 500lbs. Includes access to free fitness app, instructions and pump.

- X16955 Terra Core™ Single \$199.00 ea.
- T16956 Terra Core™ Rack (only) 299.00 ea.
- T16957 Terra Core™ Package – 6 Trainers w/ Rack 1,449.00 pk.

NEW

Smart Fitness Elite Storage Tower

Everything needed for a comprehensive workout circuit.

The Smart system consists of an array of products with self-guided workouts printed directly on them. This is perfect for maintaining proper form and moving quickly from one exercise to another. Complete circuits in less time and with less space. Setup dimensions: 70"W x 30"D x 97"H.

Elite Package includes:

- (1) Elite Storage Tower
- (6) 16mm Smart Exercise Mats
- (4) Smart Recovery Foam Rollers
- (1) 4lb., (1) 10lb., (1) 15lb. Smart Medicine Balls
- (2) 6lb., (2) 8lb. Smart Medicine Balls
- (1) 55cm, (1) 65cm, (1) 75cm Smart Stability Balls
- (2) Smart Speed Jump Ropes
- 1 each – Extra Light, Light, Medium, Heavy & Extra Heavy Smart Guard Sleeved Resistance Cables
- 1 each – Light, Medium & Heavy Mini-Bands

- X29574 Elite Package \$2,540.00 pk.
- X29575 Elite Tower (only) 1,495.00 ea.



Smart Fitness Economy Storage Tower

A convenient all-in-one medicine ball and stability ball rack for easy access and storage.

The tower also features a clip to hang extra resistance cables, bands and/or jump ropes. The Complete Economy Package includes:

- 1 Economy Storage Tower
- (1) 4 lb, (1) 6 lb, (1) 8 lb and (1) 10 lb Med Balls
- (1) 55cm and (1) 65cm Stability Balls

- X16463 Economy Package \$599.00 pk.
- 16462 Economy Tower (only) 349.00 ea.



Smart Fitness Deluxe Storage Tower

Perfect for unattended workout facilities.

The versatility of this tower allows facilities to properly display and store all the key self-guided products available for the end user in a space efficient manner. Setup dimensions: 68"W x 25"D x 74"H. Deluxe Package includes:

- 1 Storage Tower
- 2 Exercise Mats
- 2 Rollers
- (1) 4 lb, (2) 6 lb, (2) 8 lb, and (1) 10 lb Medicine Ball
- (1) 55cm, (1) 65cm, and (1) 75cm Stability Balls
- (1) 20 lb, 30 lb, 50 lb, 70 lb, and 90 lb Resistance Cables
- 5 pairs Quick Switch Handles

- C16461 Deluxe Package \$1,670.00 pk.
- X16460 Deluxe Tower (only) 1,050.00 ea.



CIRCUIT STATIONS



Skillastics™

Players complete each activity they land on as a group!

Keeps up to 100 students moving with 26 exercises and activities.

- 52233 Fitness- Grades 1st-8th \$299.99 set
- 52512 Xtreme Fitness- Grades 6th-12th 229.99 set
- 16069 Let's Move In School™- recess, before/after school 299.99 set



Circuit Training & PE Stations Class Packs

Enough equipment for a class of 32!

Pack includes:

- 1 set 12074 9' Licorice Speed Ropes
- 4 ea. 52117 Light Exercise Tubing
- 1 ea. 13123 Agility Ladder 4 Pack
- 6 ea. 42002 6.5" Training Hurdles
- 4 ea. 10239 TheZone Soccer Ball
- 800046 Circuit Training & PE Stations CD-ROM
- 2 sets 21048 9" Cones
- 1 set 26077 4" Nylon Bean Bags
- 1 set 11019 9" dia. Flying Discs
- 8 ea. Dumbbells
- 2 ea. Rubber Medicine Balls

Elementary/Middle School Pack

Includes the above with (8) X52650-2 lb. Dumbbells and (2) 29559-4 lb. Rubber Medicine Balls.

66130 \$279.99 pk.

High School Pack

Includes the above with (8) X52651-3lb. Dumbbells and (2) 29560-6 lb. Rubber Medicine Balls.

66131 \$294.99 pk.

Circuit Training & PE Stations CD-ROM

Awesome music with over 60 printable wall signs!

Includes music for a 20 or a 30 minute workout consisting of a warm up and cool down. Includes 8 and 16 station layouts to be used with or without equipment. Printable guide and wall signs included!

800046 \$29.99 ea.

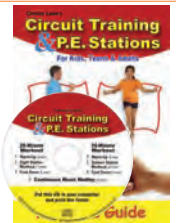

Xbox 360 DDR Energy SUPER Group Fitness Pack

For up to 8 players!

Includes an Xbox 360 Slim 4GB System with carry case, wireless controller, HDMI cable, controller charge kit, and DDR Universe game. Includes 2 Energy Metal Dance pads with a 32" x 32" playing area, 6 non slip training pads and 8 digital pedometers.

X54165 \$1,399.99 pk.



6 AND 10 PLAYER PACKS

Xbox 360 Kinect Your Shape Player Class Pack

Controller free gaming for total body workouts!

Work all muscles with included steps and exercise tubing. Most games allow scoring for 2-4 players, so the others follow along and then rotate to get their scores. Track effort through player scores and pedometers. Includes: Xbox 360, kinect sensor, 4 games, pedometers, fitmats, training cards and resistance tubing.

X53379 6 Player Pack \$1,499.99 pk.

X53389 10 Player Pack 1,879.99 pk.



HEART RATE MONITORS



iLive Wireless Activity Tracker
Free fitness app download!

- Measures heart rate
 - Pedometer distance and calorie count
 - Sleep tracker
 - Bluetooth wireless
 - DC battery power with rechargeable battery
 - Compatible with Android 4.4 or above & iOS 7.1 or above
 - Caller ID, Message notification & Call alert
- 25978\$59.99 ea.**



Ultrak Pulsometer Watch
Excellent introduction to heart rate lessons.

- Finger touch pulse testing
 - Stopwatch with split time
 - Exercise counter with auto and manual calorie counter
 - Time, alarm & calendar • Water resistant
- 16151 Ultrak Pulsometer.....\$27.99 ea.**
16152 6 Pk. w/Plastic case..... 199.99 pk.
16153 12 Pk. w/Aluminum case..... 388.99 pk.



Ekho® WMP-89™
Strapless! Transmitter belt not required.

- Current and average HR
 - % of max HR
 - Max HR during exercise
 - Calorie counter
 - Stopwatch, date, time
 - Meets NASPE standards
- 25301 Ekho® WMP-88®\$69.99 ea.**
25303 6 Pk. w/ Plastic Case..... 419.99 set
25304 12 Pk. w/ Alum. Case..... 799.99 set

ZONING FITNESS IN A BLINK

Zones	Effort	Zone®	Talk Test	Benefit	Wellness Zones	Activity	Calories Burned	*Fuel Burned	Time in Zones
Red	Hard	Very Hard Zone	"I can't talk comfortably."	Get Fast	Performance	All-Out Effort	Burn More Calories	High	Short
Yellow	Moderate	Moderate Zone	"I can talk but it's not comfortable."	Get Fitter	Fitness	Endurance	Burn Lots of Calories	Medium	Most of Your Time
Blue	Easy	Low Zone	"I can talk and it's comfortable."	Get Fit	Health	Brisk	Burn Some Calories	Low	Long

*WARNING: is the only apple®-® ZONING™, is a Division of Heart Zones® USA • www.HeartZones.com • info@HeartZones.com
Heart Zones® USA • 2634 Fulton Avenue Suite #100, Sacramento, CA 95821, USA • www.HeartZones.com • (916) 881-7243

The Threshold Training System™ ZONES CHART

Zone Number	Zone Name	Zone Description	Zone Calories Burned/minute	Zone Sustainable Workout Time	Training Load* (minutes/week)	Zone Benefits
5	Very Hard Zone	High, fast, hard effort *I don't want to end this zone! I can't talk and I'm breathing hard.	> 15 calories	15 seconds - 40 minutes	6-8-10 points**	Get Fastest
T2 HIGH THRESHOLD						
4	High Moderate Zone	Moderate and challenging effort You can talk but you're breathing hard.	10-14 calories	40 minutes - 2 hours	4 points	Get Fast
3	Low Moderate Zone	Moderate effort You can talk comfortably. You feel like you're working.	7-9 calories	1-3 hours	3 points	Get Fitter
T1 LOW THRESHOLD						
2	Low Zone	Low effort You can talk easily. You feel like you're working.	4-6 calories	2-4 hours	2 points	Get Fit
1	Low Easy Zone	Very easy effort You can talk easily. You feel like you're working.	1-3 calories	Long walking	1 point	Get Healthy

Smart PE

Using the Heart Zones and Zoning PE Software

Sally Edwards and Deb Van Klee

Includes: Curriculum, PE Software, Heart Zones Bridge, 24 Port Charging Hub, Plastic Storage Cases, Zoning Cards and Wall Charts, Heart Zones PE Software, one-time license fee (no yearly fees), Installation Consulting * iPad not included



DOUG 169 31 5.1 89	SALLY 65 35 0.0 115	ALBERT 136 31 3.7 95	ALAN 106 31 2.6 105
PETER 163 31 4.8 97	DIANA 65 35 0.0 116	JAMES 170 31 5.1 98	MARIA 159 30 4.7 102
BLAISE 101 34 2.4 108	ERNEST 118 30 3.0 84	ALESSANDRO 155 28 4.3 85	JAMES 146 31 4.1 99

ZONING FUN & FITNESS IN A BLINK

3 Easy Steps

STEP 1. TIMING: 5-20-5
5 minutes of warm up, 20 minutes of ZONING and 5 minutes of cool down, four times a week.

STEP 2. EFFORT: Blue-Yellow-Red
Warm up in the easy Blue Zone, go harder in the moderate Yellow Zone and give it your all out effort in the hard Red Zone.

STEP 3. VARIETY: Change It Up.
Each time the music or instructions change, change your effort to a different zone: blue-yellow-red.

www.heartzones.com

VISIT PALOSSPORTS.COM FOR COMPLETE DETAILS

Heart Zones Smart PE System

Wearable technology designed to engage, assess and motivate physical activity. The first comfortable heart rate sensor that is worn on the forearm. Provides real-time feedback with multiple sensors for engagement and motivation. Track heart rate, steps, MVPA, calories, distance, and speed, time in zones, step rate, and step intensity. Choose individual Blink arm bands or the full curriculum pack, which includes PE software, storage, charging station and the Heart Zones Bridge. The Bridge allows for real-time data collection using iPads (not included), which can be projected onto a wall or screen to allow teachers and students to monitor their status. The Curriculum Smart Packs includes:

- Heart Zones curriculum • Blink 3.0 Armbands • Heart Zones Hanging Charging Station • Heart Zones Bridge • 24 Port Charging Hub • Plastic Storage Cases • Zoning Cards and Wall Charts • Heart Zones PE Software, one-time license fee (no yearly fees) • Installation Consulting * iPad not included
- 16274** Blink 3.0 Armband Sensor - Blue S/M **\$83.99 ea.**
16275 Blink 3.0 Armband Sensor - Red M/L **83.99 ea.**
16276 10 Sensor Smart Pack - (5) Blue S/M, (5) Red M/L **3,094.99 pk.**
16277 20 Sensor Smart Pack - (10) Blue S/M, (10) Red M/L **3,947.99 pk.**

PEDOMETERS



Mac-T™ Pedometers

A cost effective 3 function pedometer!

- Measures up to 99,999 steps
- Counts steps, calories and distance
- Easy to operate
- 5 step delay prevents false counting
- Alligator spring clip



25839 SETOF6	\$49.99 set
25840 12 Pack with 1 plastic storage case	96.99 pk.
25841 24 pack with 2 plastic storage cases	184.99 pk.



Step Counter Pedometer

Keep it simple and just track steps!

- Measures up to 99,999
- Single button operation
- 2 second reset delay
- Tough metal clip
- Low power consumption
- Available individually in black

25423 Black	\$10.99 ea.
25439 SETOF6	66.99 set

Black Step Counter Pedometer Class Packs

Includes plastic storage case, 15 pedometers per case.

25424 15 pack	\$173.80	SALE \$149.97 pk.
25425 30 Pack	347.60	SALE 289.97 pk.
25426 90 Pack	1,043.00	SALE 799.97 pk.



Aluminum Storage Case

Protect your fragile equipment.

Pre-cut foam allows you to safely store up to 30 heart rate monitors with plenty of room for straps and other accessories. Lockable case measures 17.5"W x 15"L x 9.75"H.

25200	\$99.99 ea.
-------------	-------------



Ekho® Pedometer

Dependable performance!

- 95% certified accuracy
- Delayed reset button
- Loss prevention strap
- Spring loaded alligator clip
- Extra large digital display
- Hinged protective cover
- User-changeable battery

52961 Ekho® One-Steps only	\$15.99 ea.
52963 Ekho® Three-Steps, Distance, Calorie & Exercise Time	18.99 ea.

Ekho™ Pedometer Class Packs

Includes plastic storage case, 32 pedometers per case.

56023 Ekho® One Pedometer Class Pack of 32	\$469.99 pk.
56024 Ekho® Three Pedometer Class Pack of 32	529.99 pk.



Pocket Pedometer Storage Panel

Open pocket system for Fast check out and quick inventory control!

Keep track of pedometers assigned to students with this storage panel. The panel is made from a durable nylon with 3.75"L x 4"H clear PVC pockets. Pockets are numbered 1-35. Three grommets along the top makes it easy to hang anywhere. Pedometers not included.

25023	\$19.99 ea.
-------------	-------------

Replacement Pedometer Batteries

We have the batteries you need.

Easy to replace, we offer these batteries to you at great prices! The 25103 is universal for most pedometers.

25103 LR44	\$1.09	SALE \$0.87 ea.
25135 LR43 & L1142	1.09	SALE 0.87 ea.
25947 LR1130	1.09	SALE 0.87 ea.



WARNING: CHOKING HAZARD- Small parts. Not for children under 3 yrs.



Plastic Storage Case

Durable hard plastic case stores 15 pedometers, straps and tokens.

25156	\$8.99 ea.
-------------	------------

FITNESS TESTERS



SPORTS HEALTH Modified Pull-Up Bar
Designed for easy transport and storage!

Ideal for training for the Fitnessgram® modified pull-up test. Made of strong, but lightweight steel. Adjust to 8 different height settings – from 20" to 34"H. Bar features a rubber, no-slip, comfort grip for safety. Attached red strap marks "official" pull-up height. Assembles without tools.

25899 \$249.99 ea.



HEIGHT ADJUSTS FROM 25", 35" OR 6"

SPORTS HEALTH Push-Up Mat

Teaches the proper push up technique!

This double sided mat uses strategically placed palm markings and an adjustable soft foam chest block to teach proper hand placement and body positioning for an accurate push-up. Removable foam block attaches with Velcro® to adjust height from 3" to 6". Made of phalate free PVC. Dimensions: 30.5" x 19".

25981 Single..... \$39.99 **SALE \$31.97 ea.**
25982 Set of 6..... **239.90 SALE 184.97 set**



STANDARD

DELUXE



Baseline® Sit n' Reach® Flex Tester

Use to measure flexibility in a variety of children's fitness tests.

This tester works with fitness programs such as the Presidential Physical Fitness Test, FitnessGram®, YMCA and SHAPE.

Top scale is clearly marked in inches and centimeters. Designed with built-in footplate and maximum stretch indicator. The Deluxe Flex Tester offers an adjustable start point that can be used to normalize scores to account for variation in arm and leg length of the person tested.

25018 Standard 21"L x 13"W x 12"H \$129.99 **SALE \$114.97 ea.**
16749 Deluxe 30"L x 13"W x 12"H **199.99 SALE 179.97 ea.**



Poly Push-Up Mat

Designed for push-up testing and training!

The Push-Up mat is the first mat of its kind designed to teach students the proper hand placement along with a permanent foam block used as a chest guide, making it a "correct push-up". Constructed of heavy vinyl. Measures 30.5" x 19.75".

25060 \$39.99 ea.

ONE PERSON

TWO PERSON



Flex-Tester

Choose from one or two person models.

Quality powder coated steel construction with non-marring base. Folding foot plates for easy storage. Smooth glide reach indicators with easy to read standard and metric calibration. Use with Fitnessgram®, SHAPE, & other national testing programs.

X25529 One Person Tester..... \$109.99 **SALE \$96.97 ea.**
25980 Two Person Tester **149.99 ea.**

FITNESS TESTERS



Abdominal Crunch Strips

A simple physical fitness curl-up test.

The rubber strips lay flat on the floor at the user's finger tips. When the user extends to the far edge of the strip, the proper distance has been reached.

25035 Grades K-4, 30"L x 3"W \$4.19 ea.

25037 Grades 5 & up, 30"L x 4 1/2"W 4.19 ea.



SPORTS HEALTH

Curl Up Assessment Mats

Raised lines allow users to feel the start and finish points!

Allows students to maintain proper form. Mat is made from 1/2" thick closed cell foam with vinyl cover and glued in lines at both ends. One end features 3" lines the other end measures 4.5". Mats measure 48"L x 24"W.

25183 SET OF 6 \$179.99 SALE \$159.97 ea.

25187 Assorted Colors 31.99 SALE 27.97 ea.



CONTOURED HANDLES
ELIMINATES JAMMED FINGERS



SPORTS HEALTH ShuttleSafe

Designed for safe and accurate shuttle run tests!

Contoured handles eliminates jamming fingers into the floor and the triangular end pieces keep the ShuttleSafe in place. Yellow only.

25230 \$7.99 ea.

25276 Set of 6 \$47.90 SALE 39.97 set



Long Jump Mat

Assess jumping skills!

Practice developing long jump skills and record lengths with this durable and portable mat. The green durable rubberized foam mat measures 11'L x 27"W with distance increments marked from 3'-10'. The included nylon carry bag with drawstring closure allows for easy travel. Just unroll and you're ready to go!

25052 \$84.99 ea.

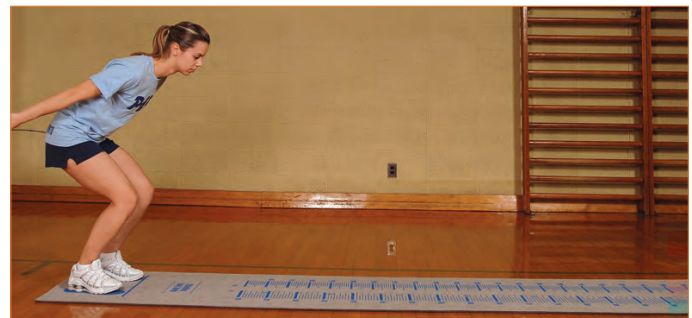

Deluxe Standing Long Jump Test Mat

Just unroll and you're ready to go!

A high quality non-slip, rubber mat with measurements in centimeters and inches for testing the standing long jump. Will not tear or wrinkle and is puncture resistant. Measures 144"L x 22"W x 1/4" thick and provides excellent grip at take off and cushions landings. Weighs 45 lbs.; rolls for storage. Includes a complete manual with norms for various age groups and skill levels.

X25010 \$285.99 ea.

Vertical Challenger

Accurate and affordable!

Telescopes to measure vertical jump from 4 to 12 feet. Moveable arms are placed at 1" increments to allow for accurate measurements. Heavy duty base has easy glide casters for transport. Frame is made from powder coated steel and includes the 22 lb. stability weight.

X52973 \$394.99 ea.

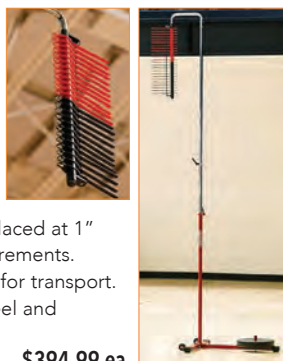

Jump and Reach Board

Accurately measures leg power.

Easily mounted metal board is adjustable for children and adults. Included are two magnets which are placed on board at peak of jump. Graduations are silk-screened on board in 1/8" increments. Magnet (shipped on back of board) eliminates errors. Weighs 9 lbs.

25100 \$72.99 ea.

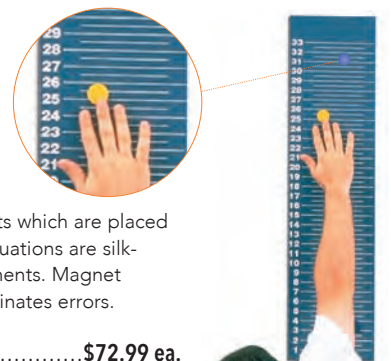

FITNESS TESTERS



NEW

Baseline® Body Fat Analyzer

Lightweight and portable credit card style.

Measures body fat % in a 5-50% body fat with 0.1% resolution. Calculates and store results for up to 8 people. 3V lithium battery included.

25985 \$10.99 ea.



NEW

Baseline® Mini Body Fat Analyzer

Palm sized unit features clock and alarm.

Measures body fat % in a 5-50% body fat with 0.1% resolution. Calculates and store results for up to 8 people. 3V lithium battery included.

25986 \$10.99 ea.



InstaPulse™ Monitors

Digital read-out of your pulse rate in a matter of seconds.

The hand-held design of this monitor takes the complication out of finding your heart rate. Just grab with both hands and your rate appears in less than one minute. Accurate to within one beat per minute. The silver edition is water and weatherproof. It can be used in pool environments. The gold edition is water resistant and comes in four models – 7 inch, 11 inch, wall mount or floor stand. Optional storage case holds six 7" batons or four 11" batons. Requires (1) 9V battery (included).

- 25988 Silver 7" Monitor \$129.99 ea
- 25055 Gold 7" Monitor 129.99 ea.
- 25040 Gold 11" Monitor 137.99 ea.
- X25041 Wall Mount w/ 11" Gold Monitor 296.99 ea.
- X25042 Floor Stand w/ 11" Gold Monitor 279.99 ea.
- 25215 Storage Case 15"L x 10" W 49.99 ea.

EVERYTHING YOU NEED TO CALCULATE BMI IN ONE PACKAGE

NEW

School Health BMI Package

Everything you need to calculate BMI in one package.

This comprehensive package includes all the components necessary to accurately calculate a student's BMI. The kits comes with one SECA portable stadiometer, one scale, Tanita tear pads, and a BMI percentile spreadsheet.

SH61640 \$407.00 pk.



Basic Assessment Pack II

Create a 6 person testing station!

Includes:

- 2 ea. 25981 Push-Up Mat
- 2 ea. 25018 Flex-Tester
- 1 set 25183 Curl UP Assessment Mats

66553 \$469.99 **SALE \$399.97 pk.**



Basic Assessment Pack I

Includes:

- 1 ea. 25981 Push-Up Mat
- 1 ea. 25018 Flex-Tester
- 6 ea. 25035 Abdominal Crunch Strips: K-4
- 6 ea. 25037 Abdominal Crunch Strips: 5 & Up

66595 \$129.99 pk.

SCALES/BODYFAT ANALYZERS



NEW

Baseline® Body Fat Scale

Measures body fat, muscle, and water percentages.

- Tempered glass with LCD screen
- 5 activity levels and 12 user memory
- 4% - 45% body fat; 37.8% - 66% body water
- 0.2lb. /0.1% BF/water resolution
- 330lb. capacity
- 12.5" L x 12.25" W x 2" H
- 3V battery included

25987 \$42.99 ea.



Stainless Steel Scale

Digital high-capacity, thin profile scale!

- High precision strain gauge sensor
- Tempered glass platform
- Stainless steel surface
- Digital, blue-light display
- Measures 11" x 11.75" x .875"
- Weight capacity: 379 lbs.
- Batteries included.

25984 \$29.99 ea.



Body Comp Scale

Calculates weight and body composition.

- Max. weight 397 lbs. at 0.2 lb increments
- Records body fat % and BMI to 0.1% graduation
- Stainless steel sensors
- User range- 10-80 years old
- 10 user memory
- Includes AAA batteries
- Measures 11.75" x 11.75"

25919 \$39.99 ea.

Health-O-Meter® Remote Display Scale

With serial port to connect to your PC!

- 1/2" LCD display
- Platform measures: 12" x 12 3/4"
- 400 lb. x .2 lb. weight capacity
- Non-skid durable platform
- Includes 6 AA batteries
- Weighs 22 lbs.

18041 \$229.99 ea.



Health-O-Meter® Floor Scale

With a large speedometer type dial that is easy to read.

Constructed of a steel base and extra large platform with a non-peel cover. Weight capacity: 400 lbs. Dimensions: 18.5" L x 11.5" W.

X18062 \$162.99 ea.



Health-O-Meter® Beam Scale

All metal construction!

- Platform measures: 10 1/2" x 14"
- Scale height: 57 1/2"
- All metal 24" - 84" height rod
- Easy cleaning ABS plastic platform cover
- 500 lb. x 1/4 lb. weight capacity
- Weighs 43 lbs.

18014 \$249.99 ea.

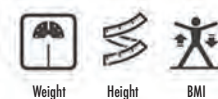

Health-O-Meter® Digital Scale

Strong aluminum pillar!

- Platform measures 15 1/2" x 12 3/4"
- 1" LCD eye level display
- Built in height rod
- Durable non-skid platform
- Strong aluminum pillar
- Includes 6 AA batteries
- 500 lb. x .2 lb. weight capacity
- Weighs 25 lbs. • Two Year Warranty.

18050 \$424.99 ea.



Health-O-Meter® Digital Scale with BMI

1" LCD display with 350° swivel head!

- Max. wt. capacity 600 lbs.
- Measures in .2 lb. increments
- Includes 120V adapter
- Serial port and USB connectivity
- Platform is 14 1/2" L x 14 3/4" W
- Operates on 6 C batteries-not included
- Wheels for transport
- Weighs 36 lbs.

25149 \$589.99 ea.



OBSTACLE COURSES

INCLUDES:

- ➔ 5 TALL 18" PLATFORMS
- ➔ 2 SHORT 9" PLATFORMS,
- ➔ 7 PLATFORM CAPS
- ➔ 4 RAILS WITH NONSLIP PADS ON ROUND SIDE
- ➔ TRAINING MANUAL



Fitness Equipment	Cardio	Low Body Strength	Upper Body Strength	Agility & Coordination	Global Movement Skills	Can Be Used For All Ages	Portable
Railyard Obstacle Course	yes	yes	yes	yes	yes	yes	yes
Treadmill	yes	yes	no	no	no	no	no
Stair Climber	yes	yes	no	no	no	no	no
Glider	yes	yes	no	no	no	no	no
Weight Machines	no	yes	yes	no	no	no	no

Railyard Fitness Obstacle Course Package #1

A portable, lightweight, modular obstacle course where kids and adults have fun exercising!

Great for group and individual exercises! Course variations include: 38 ft. single rail for speed and agility drills like quick overs, or strength and flexibility exercises such as bear crawls; 2 – 19 ft. parallel rails for more complex speed and agility drills that combine multiple exercises; or position rails at 9", 18" 27" or 36" to add variety, challenge, and effectiveness to each of the exercise. Package includes: 5 tall platforms (bases), 2 short platforms, 7 platform caps, 4 rails, and training manual. Rails hold up to 600 lbs. Recommended space: 200 sq. ft. Ships via truck.

T117272.....\$4,225.00 set



INCLUDES:

- ➔ 7 TALL 18" PLATFORMS
- ➔ 2 SHORT 9" PLATFORMS
- ➔ 7 PLATFORM CAPS
- ➔ 5 RAILS WITH PADS ON ROUND SIDE
- ➔ 1 TRAINING MANUAL

GREAT FOR KIDS!

Railyard Fitness Obstacle Course Package #2

Gives you the widest variety of stations to maximize your budget.

Recommended for groups of 10 people and up. Strength training, speed, agility and flexibility are all within reach. With this package, you can have one rail at the high (36") position at all times. This set has everything needed to prepare even the most rigorous of challenges. Includes: 7 tall platforms (bases), 2 short platforms, 7 platform caps, 5 rails and training manual. Rails hold up to 600 lbs. Recommended space: 250 sq. ft. Ships via truck.

T117273.....\$5,280.00 set

LOCKS



01820 Grey



Master® Combination Locks-No Key

BlockGuard™ Anti-Shim Technology blocks typical shim-
ming tools from opening locks and deters break-ins!

- Fits standard lockers
- Dial locks automatically under shackle tension
- Combination automatically scrambles when lock is closed
- Double reinforced stainless steel case
- 3/4" nickel plated hardened steel shackle
- *Minimum order is 25 locks. Locks are custom and non-returnable.

Specify Color\$6.29 **SALE \$4.97/25+**



01814 Red 01815 Orange 01817 Green 01818 Blue 01819 Purple 01816 Gold 01809 Black



American® Combination Locks with Key
BlockGuard™ Anti-Shim Technology deters break-ins!

- Fits standard lockers
- Combination automatically scrambles when lock is closed
- Double reinforced stainless steel case
- 3/4" nickel plated hardened steel shackle
- One FREE Key with each lock order
- *Minimum order is 25 locks. Locks are custom and non-returnable.

01807 Specify Color \$6.29 /25+
01805 American® Lock Control Key 7.99 ea.



01810 Black



Master® Combination Locks with Key
BlockGuard™ Anti-Shim Technology blocks typical shim-
ming tools from opening locks and deters break-ins!

- Fits standard lockers
- Dial locks automatically under shackle tension
- Combination automatically scrambles when lock is closed
- Double reinforced stainless steel case
- 3/4" nickel plated hardened steel shackle
- One FREE Key with each lock order
- Order additional keys separately at time order is placed
- *Minimum order is 25 locks. Locks are custom and non-returnable.

Specify Color\$6.99 **SALE \$5.97/25+**
01811 Master® Lock Control Key 7.99 ea.



01821 Red 01822 Orange 01824 Green 01825 Blue 01826 Purple 01823 Gold 01827 Grey



01842 Red



Master® Letter Lock™ With Key
Easy to dial and remember 3 letter combination!

- Fits standard lockers
- Automatic locking
- Double reinforced stainless steel case
- 3/4" nickel plated hardened steel shackle
- One FREE Key with each lock order
- Order additional keys separately at time order is placed
- *Minimum order is 25 locks. Locks are custom and non-returnable.

Specify Color \$6.29 /25+
01850 Letter Lock Control Key 7.99 ea.



01847 Purple 01843 Orange 01844 Gold 01845 Green 01848 Grey 01846 Blue 01849 Black

IMPORTANT WHEN RE-ORDERING LOCKS

CONTROL NUMBER: To use your current control key specify the Control Key number on the back of your current locks.



CONTROL KEY #

Refer to minimum order on locks. Locks are custom ordered and non-returnable.

Zephyr Combination Locks with Key

New patent pending anti-shim feature deters break-ins!

- Fits standard lockers
- Resists the most common shim-
ming methods
- Double reinforced stainless steel case
- .81" hardened steel shackle
- Black dial
- One FREE Key with each lock order
- Locks are non-returnable
- *Minimum order is 10 locks. Locks are custom and non-returnable.

01851 \$6.50/10+
01852 Control Key 3.99 ea.

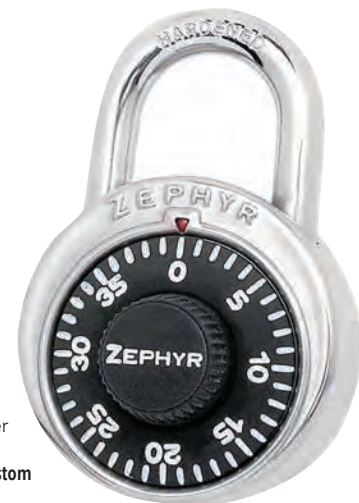

SWIMMING EQUIPMENT

Kiefer® Thrust Fins

Full length fin for maximum speed. Optimal for all types of swimmers. Soft rubber floating fin. Sizing based on men's shoe size. Specify Size.....\$28.99 pr.



ROYAL Sizes 5-7	RED Sizes 7-9	NAVY Sizes 9-11
58130	58131	58132



Ultrak 460 Stopwatch

Water resistant with extra large display!
 • Single Event • Timing capacity: 100 hours • Lap, Split, Dual Split
 • 1/1000 Resolution • Memory: 16
48097 Orange Stopwatch \$25.99 each
48159 Set of 6 Orange..... 155.94 **SALE 144.97 set**
48166 Set of 6 (one of each color) 155.94 **SALE 144.97 set**

Mikasa Official Water Polo Ball

Official Size and weight. All rubber with an easy grip surface. The game balls are NFHS approved.
58204 Mens Game W6000.....\$36.99 ea.
58202 Mens Practice W5000..... 24.99 ea.
58170 Game Ball 6 Pack- 6 W6000 Balls..... 221.99 pk.



Finis® Team Water Polo Cap Sets

Cap conforms to head shape comfortably! Made from form fitting nylon fabric with tie closure. Sets include 13 caps numbered 1-13 with 2 red goalie caps #1 and #13. Team extender set is numbered 14-26.
X58125 Navy Team Set #1-13\$119.99 set
X58126 White Team Set #1-13 119.99 set
X58127 Navy Team Extender Set #14-26 119.99 set
X58128 White Team Extender Set #14-26 119.99 set



Mesh Noodle Bag

Use for noodles and other wet items! Made from polyester mesh with heavy duty nylon web handles, shoulder strap and zippered closure. Blue only. Measures 60"L x 20"W.
36049 \$17.99 ea.



BIODABLE NOODLE CONNECTORS

Foam Water Noodle

Affordable fun floating foam water log. This 58" long by 2.75" diameter floating device is an excellent substitute for kick boards or just a fun floating water apparatus.
X58021 Box of 20\$75.99 box
32363 Noodle Connectors 6" - Set of 12..... \$31.99 **SALE 24.97 set**
32362 Noodle Connectors 10" - Set of 12 39.99 **SALE 29.97 set**

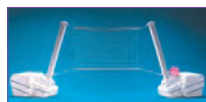

Splash and Slam

Portable regulation size pool basketball. Fiberglass backboard has 2' of overhang. Vinyl coated steel rim easily adjusts without tools from 2' to 6' above water level. Four way leveling system accommodates sloped decks. Super tough polyethylene base weighs 500 lbs when filled with water. Comes complete with regulation size, color matched ball. 3 YEAR GUARANTEE. Conversion kit will convert 1 basketball unit to a volleyball set! Includes 1 additional base, 4 height adjusting brackets, hardware, 1 volleyball and a 32' net with extension rope to accommodate a 70' pool. Ships by truck.
T58026 One basketball unit only.....\$759.97 **SALE \$759.97 ea.**
T58029 Conversion Volleyball kit.....385.99 set



Pool Shot Varsity II Professional Basketball

Includes an official vinyl basketball! Constructed from thick walled UV treated polyethylene and measures 43"H x 53"W with three 8" 45 degree angled wings for safe and simple ball return. The base measures 34"W x 47"H x 28" deep and can hold approx. 400 lbs. of water for ballast. Regulation size 18" steel rim, galvanized with powder coated orange finish. Hardware is all stainless steel and aluminum to resist rust. Adjustable rim height of 36" to 45" from pool deck. Deck space required is 3'W x 3'D. Weighs approx. 96 lbs. Call for freight quote-our normal shipping policy does not apply to this item.
C58034 \$649.99 **SALE \$589.97 ea.**



SWIMMING

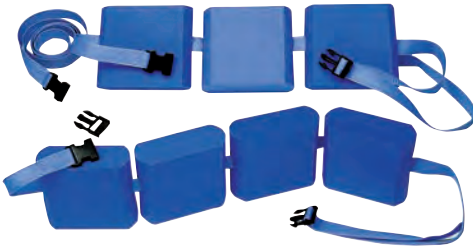

Swim Belts

Popular swim trainer for beginners of all ages. Soft, comfortable closed cell EVA foam will not absorb water or crack. A 60" belt with easy-on buckle.

- 58078 3-Piece \$12.99 **SALE \$9.97 ea.**
- 58079 4-Piece 13.99 **SALE 10.97 ea.**



Rescue Tube

Made of Coast Guard approved material! Specially coated, triple dipped foam to protect against the elements. Tube comes with GUARD lettering, nylon shoulder straps with adjustable clips. Red only. Measures 50" x 6" x 4".

- 58043 \$54.99 ea.



AquaJogger® Buoyancy Belt

No impact workout!

This unique floating device allows you to stay afloat while exercising in the water. Constructed of premium EVA closed cell foam with an easy quick lock belt. Adult size fits waists up to 42" waist; youth size belt fits up to 36" waist. Complete with a water workout guide and video.

- 58092 Adult Jogger \$49.99 **SALE \$44.97 ea.**
- 58093 Jr. up to 95 lbs. 34.99 **SALE 29.97 ea.**

Kiefer® Classic Training Kickboard

All purpose training board. Made from durable molded EVA foam with an easy grip surface. Measures 19"L x 12"W x 1" thick.



- 58101 Single Board \$14.99 ea.
- 58102 12 Pack 164.99 pk.



Sprint Deluxe Goggle

For youth or adults!

- Foam seal
- Silicone headband
- Recreational performance

- 58091 Clear \$4.99 ea.
- 58095 Blue 4.99 ea.



Sprint Snorkel & Mask Set

An affordable combo set!

Made from soft PVC for comfort and a tempered glass faceplate for durability.

- 58039 \$29.99 ea.



Sprint Latex Swim Cap

One size fits most.

Durable, latex rubber cap. Features anti-tear edges. Color: white. One dozen.

- 58046 \$20.99 dz.



Silicone Swim Caps

Top of the line quality!

Sold in solid color dozen packs.

Specify Color \$47.99 dz.

RED	ORANGE	YELLOW	GREEN	
58114	58115	58116	58117	
BLUE	PURPLE	WHITE	BLACK	NAVY
58118	58119	58120	58121	58122



Coop Wet Balls

Textured panels for easy grip!

Machine stitched soft neoprene cover with rubber bladder. Easy to grip. Safe for all ages. Assorted colors.

- 32011 Intermediate Football \$13.99 ea.
- 33102 Official Size Volleyball 15.99 ea.



Spikebuoy™

Use with your existing Spikeball™ set to convert to water play!

Spikebuoy enables your Spikeball set to float on any water surface or depth. Standard game rules apply with one exception. Any shot that lands outside the pool is out of bounds. More shallow water = more running and dives. Fill the carrying bag with a 3 to 4 lb. item to serve as the anchor. Includes 5 leg floats & straps, and 1 anchor bag. Spikeball™ sold separately.

- 10599 Spikebuoy™ \$30.00 ea.
- 10575 Original Spikeball™ Set. 59.00 ea.

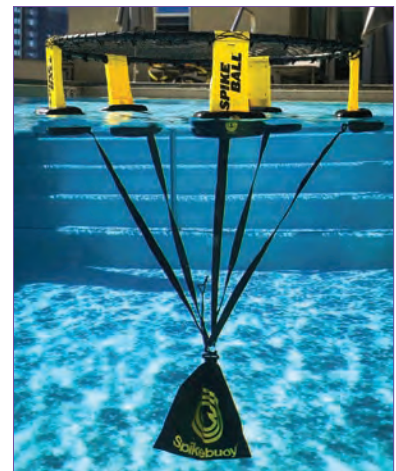

TAPE WRAP



School Health Brand Athletic Tape

High-quality economical breathable tape!

School Health Brand cotton athletic sports tape is easier to tear than traditional athletic tapes. School Health Brand Athletic Tape is made for wrapping hands, ankles and other body parts for protection and support during sports activities.

28199 1 1/2" x 15 yds., White 32 rolls/case **\$53.50 cs.**



Mueller M-Tape®

M Tape is a must have item for all gear bags and coaches bags.

The M Tape is made for wrapping injuries and adding support to players ankles or wrists. M Tape can be torn easily to make the perfect width. Rolls are made of hospital-grade, 100% cotton backcloth. Available in white in 3 sizes and quantities. Team Colors are available in 1 1/2"x10 yds. 32 per case only.

18270 1 1/2" x 15 yds., 32 rolls/case (white) **\$68.99 cs.**

18271 1" x 10 yds., 48 rolls/case (white) **68.99 cs.**

18272 2" x 15 yds., 24 rolls/case (white) **68.99 cs.**

Black	Blue	Green	Gray	Red	Maroon	Case
18386	18387	18388	18389	18390	18391	78.99
Gold	Orange	Purple	Beige	Pink	Navy	
18392	18393	18394	18395	18396	18397	



Cramer® 750 Athletic Tape

Computer calibrated unwind for consistency and performance roll to roll.

A high-quality cotton tape at an affordable price. Zinc Oxide. Measures: 1 1/2" x 15 yds., White, 32 rolls/case.

18125 **\$56.99 cs.**

Cramer® Team Colors Athletic Tape

Zinc oxide cotton tape provides the extra support athletes need. Easy hand to hand tear and highly conformable to body. Measures: 1 1/2" x 10 yds., 32 rolls/case.



Black	Red	Blue	Gold	Orange	Pink	Purple	Case
18176	18177	18178	18179	18180	18181	18182	72.99



Cramer® 950 Porous Athletic Tape

High-quality, economically priced porous tape alternative. Constructed out of 100% cotton backcloth and adhesive.

18174 1" x 15 yds., 48 rolls/case . **\$64.99 cs.**

18171 1 1/2" x 15 yds., 32 rolls/case . **62.99 cs.**

18175 2" x 15 yds., 24 rolls/case ... **64.99 cs.**

J&J COACH Athletic Tape Speed Packs

Preferred by athletic teams and trainers.

Breathable porous sports tape that protects joints from strains, sprains or injuries. Offers support that can help speed recovery from sports related injuries.

18273 1 1/2" x 15 yds. 32 rolls/case **\$79.99 cs.**



J&J ZONAS® Athletic Tape Speed Packs

Easy to tear without scissors!

J&J Zonas porous tape provides breathable support for strains and sprains. This tape has a high tensile strength to wrap injuries securely, but with a cotton cloth backing that allows perspiration to escape from skin to help reduce irritation.

18275 1 1/2" x 15 yds. 32 rolls/case .. **\$84.99 cs.**

UNDERWRAP/TAPE



SH School Health Brand Underwrap

A natural-colored, polyurethane pre-taping foam underwrap used to protect the skin from tape. 2³/₄" x 30 yards.

- 18277 48 rolls/case.....\$49.99 cs.
- 18278 12 rolls/box.....12.77 box



Mueller® Kinesiology Tape

Adhesive is heat activated by rubbing during application. Features a revolutionary design that microscopically lifts the skin to maintain flexibility, improve circulation of blood and relieve pain. Mueller Kinesiology Tape is applied to the skin in patterns that mimic the muscles. Designed to aid in ligament injuries, muscle conditioning, fascia repositioning and even carpal tunnel syndrome. 2" x 16.4 ft., 6/case

- 18305 Beige\$58.99 cs.
- 18306 Black.....58.99 cs.
- 18307 Blue.....58.99 cs.
- 18308 Pink.....58.99 cs.



TheraBand™ Kinesiology Tape

TheraBand Kinesiology Tape provides research-proven pain relief. Eliminates misapplication – even for beginners – with exclusive XactStretch Technology. Stretch guide indicators allow users to get the right stretch, every time. This tape sticks and provides durable support for up to 5 days. Standard Continuous Rolls, 2" x 16.4', 6 rolls/pk.

- 18302 Black/Black\$59.99 pk.
- 18303 Beige/Beige.....59.99 pk.
- 18304 Blue/Blue.....59.99 pk.



Cramer® Colored Underwrap

Latex free foam wrap protects the skin from irritation. Used to help eliminate skin irritation caused by repeated taping and to secure cold packs and bandages. Available in eleven colors. 2³/₄" x 30 yds., 48 rolls/case.

Black	Blue	Brite Green	Green	Red		Case
18201	18200	18204	18198	18214		\$53.99
Yellow	Orange	Purple	Brite Yel	Brite Pink	Teal	
18202	18199	18203	18205	18207	18206	



Mueller® M-Wrap® Colors

Pre-taping foam underwrap helps protect skin from tape. M-Wrap can be used to keep hair out of face, hold pads and socks in place, and as a protective wrap inside athletic footwear. Water resistant - can be worn up to 3 days. 2³/₄" x 30 yards. 48 rolls/case.

Black	Blue	Lime Green	Green	Red	Navy	Natural	Case
18290	18291	18299	18294	18289	18292	18288	\$51.99
Gold	Orange	Purple	Maroon	Pink	Aqua	Sunburst	
18295	18296	18297	18298	18293	18301	18300	



Mueller® Tuffner® Pre-Tape Spray

Strong adherence without irritating skin! Spray adherent helps secure tapes and wraps. Clear.

- 18309 4 oz.....\$7.99 ea.
- 18310 10 oz.....9.99 ea.



BANDAGES



SH School Health Brand Elastic Bandages

School Health Brand Elastic Bandages offer high quality and consistent support. These bandages are great for securing cold packs, splints, and dressings. School Health Brand Elastic Bandages are a premier solution at an economy price. Be prepared to address the needs of your students or athletes and their injuries. Packaged in cellophane.

Elastic Bandage with Clips	Elastic Bandage with Hook and Loop Closures
18323 2" x 5 yds. \$7.76 box	18335 2" x 5 yds. \$10.70 box
18325 3" x 5 yds. 8.91 box	18337 3" x 5 yds. 17.45 box
18327 4" x 5 yds. 13.75 box	18339 4" x 5 yds. 20.45 box
18329 6" x 5 yds. 19.75 box	18341 6" x 5 yds. 31.55 box
18331 4" x 10 yds. 25.00 box	18343 4" x 10 yds. 57.70 box
18333 6" x 10 yds. 32.30 box	18345 6" x 10 yds. 75.85 box



Johnson & Johnson Band-Aid® Strips

From simple scratches to stubborn cuts we got a BAND-AID® to cover it! A wide selection of bandages in assorted sizes for various first aid needs. Flexible Fabric bandages, provide comfortable protection that stretches and flexes as you move. Sheer Strips Bandages are designed to stay in place while they cover and protect minor wounds.

Flexible Fabric Strips	
18312 3/4 x 3", 100/box	\$9.41 box
18313 1" x 3", 100/box	8.12 box

Island pad with 360° adhesive protection!



SH School Health Brand Adhesive Bandages

Island pad with 360° of adhesive protects the wound from dirt and germs with a four-sided seal. School Health brand adhesive bandages provide maximum conformability and flexibility for greater comfort. Breathable and durable protection with premium adhesive that stays secure under the most active conditions.

Sheer Strips	
18317 3/4 x 3" 100 ct.	\$2.95 box
18318 1" x 3" 100 ct.	3.42 box
Flexible Fabric Strips	
18319 3/4 x 3" 100 ct.	3.76 box
18320 1" x 3" 100 ct.	4.28 box
18321 2" x 4" 50 ct.	7.01 box



Coverlet® Cabinet

Consolidate all your Coverlet supplies in one area. Eighteen-drawer cabinet holds 18 boxes of Coverlet® Adhesive Bandages included. Drawers are removable for simple refilling. Can be mounted on wall. Size: 14 7/8" W x 18 1/2" H x 6 3/8" D

18316	\$125.50 ea.
-------------	---------------------



Bandage Packs

Assorted bandages to refill your kits!
 Full Pack Includes: 10 3/4" x 3", 5- 2" x 4 1/2", 5-butterfly style, 6-fingertip, 6-knuckle and 10 gauze pads. C-Strips include: 100-1" x 3" bandages.

18064 Full Pack	\$13.99 pk.
-----------------------	--------------------

GLOVES/ICEPACKS

School Health Brand Nitrile Exam Gloves

- Comfortable fit
- Excellent sensitivity
- Dependable protection
- Reliable grip
- Crisp blue color
- NOT MADE with natural rubber latex or DEHP



SH Nitrile Powder-Free Gloves

School Health's Nitrile gloves strong and flexible design are ideal for all around use. These ice blue color gloves provide a comfortable fit, dependable protection and the textured fingertips allow for a reliable grip and increased dexterity.

18350 Small 200/box.....	\$19.40 box
18351 Medium 200/box	19.40 box
18352 Large 200/box	19.40 box

SH School Health Brand Instant Cold Pack

No refrigeration needed, just squeeze to activate!

Instant cold packs relieve stiff necks, backaches, headaches, toothaches, help to lower the body temperature in case of fever, and are great for minor sporting injuries.

18348 5" x 7" 16/case	\$11.65 cs.
18349 6" x 8" 16/case	15.90 cs.



SH School Health Brand Ice Bags

No double bagging required!

This heavy-duty polyethylene bag is sturdy and very strong with a flat bottom seal with no side seams to break open. Leak proof and puncture resistant. Each bag measures 10" x 18" and 1 mil in thickness.

18346 1500 bags/roll	\$104.00 roll
----------------------------	---------------



Reusable Cold Packs

Can be used over and over!

Delivers deeper, more effective cold while remaining soft and pliable to conform to the body. 12 to a box.

18011 6" x 9".....	\$34.99 dz.
18012 4 3/16" x 6".....	26.99 dz.

Instant Cold Packs

Simply squeeze and shake for instant cold!

A one use pack, do not apply directly to skin. Packs measure 4" x 9" and are sold in a box of 16.

18010.....	\$19.99 SALE \$15.97 box
------------	--------------------------



Towels

100% cotton.
Measure 20" x 40" in size and weigh 5 lbs. per dozen.
White only.

18057	\$24.99 dz.
-------------	-------------

Clear Acrylic Heavy Duty Dispenser

Bolts easily to wall!

Holds one roll of ice bags securely and easily mounts to a wall with 4 molly bolts. Very clean and attractive in any athletic training room.

18347	\$151.00 ea.
-------------	--------------



Heavy Duty Ice Bags

Keeps ice where it belongs- in the bag!

Clear to view injury, these polyethylene bags can handle even the sharpest ice and will not leak. Tabletop or wall mount dispenser has a steel 16" x 10" x 6" frame and will hold either bag size.

18054 9.5" x 18" Bags, 1500 count	\$103.99 roll
18055 12" x 24" Bags, 750 count	104.99 roll
18056 Ice Bag Dispenser	64.99 ea.

FIRST AID KITS



SH School Health Brand 50-Person, 196-Piece Kit

- First aid guide
- 4oz Eye wash
- 4" Plastic tweezers
- 10 Insect sting relief pads
- 4 Sterile eye pads
- 20 Aspirin tablets
- 18 Sting free antiseptic wipes
- 6 - 2" x 2" Gauze dressing pads
- 100 - .75" x 3" Plastic adhesive bandages
- 2 - 2" Conforming gauze roll bandages
- 3" Conforming gauze roll bandage
- 32 sq. in. Absorbent gauze compress
- 10 Triple antibiotic ointment packs
- 4" x 5" Instant cold compress
- .5" x 10 yd. First aid tape roll
- 4.5" Nickel plated scissors
- 2 pr. Exam quality vinyl gloves
- 36" x 36" x 51" Triangular sling/bandage w/ 2 safety pins
- 2" x 5 yd. Natural latex free elastic bandage
- Latex Free CPR Pack - CPR one-way face shield, 1 pr. gloves, 3 Sting free antiseptic cleaning wipes

18353 Metal Box	\$74.10 ea.
18354 Plastic Box	\$55.34 ea.
18355 Refill Only	48.12 ea.



SH School Health Brand 25-Person, 106-Piece Kit

- 50 - .75" x 3" Adhesive plastic bandages
- 3 - 1.75" x 3" Fingertip fabric bandages
- 2 - 1.5" x 3" Knuckle fabric bandages
- 36" x 36" x 51" Triangular sling/bandage w/ 2 safety pins
- 2" Conforming gauze roll bandage
- 6 - 2" x 2" Gauze dressing pads
- 5" x 9" Trauma pad
- Sterile eye pad
- 12 Sting free antiseptic cleansing wipes
- 6 Triple antibiotic ointment packs
- 3 Insect sting relief pads
- 4oz Eye wash
- 4" x 5" Instant cold compress
- 12 Aspirin tablets
- .5" x 5 yd. First aid tape roll
- 4.5" Nickel plated scissors
- 4" Plastic tweezers
- 1 pr. Exam quality vinyl gloves
- First aid guide

18356 Metal Box	\$35.91 ea.
18357 Plastic Box	28.57 ea.
18358 Refill Only	22.87 ea.



Cramer® Coach's First Aid Kit
A 100 piece kit!

Over 50 bandages, a variety of antiseptics and ointments, gauze pads, applicators, gloves, tape, an ice pack and instructional guide. Created with supplies for cuts, burns, severe bleeding and CPR. Ballistic nylon case with an easy access pocket system for smart organizing.

18082 7" x 5" x 2.5"	\$27.99 ea.
-----------------------------------	--------------------



All-American First Aid Kit
Nylon and clear vinyl pouch!

Includes: adhesive bandages, large bandages, gauze pads, roll of 2" gauze, antiseptic wipes, triple antibiotic ointments, sting relief wipes, roll of 5 yard tape, cold pack, scissors and latex gloves. Measures 9.25"W x 5.5"H

18019	\$21.99 ea.
--------------------	--------------------



Defender Kit

Terrific kit for general first aid. Soft sided nylon and clear vinyl pouch helps you locate the following items: 15 adhesive bandages, 2 large bandages, 3 gauze pads, 6 antiseptic wipes, 3 triple antibiotic ointments, 3 sting relief wipes, one 2.5 yd. roll of tape, 1 cold pack and 2 gloves.

18030	\$19.99 SALE \$16.97 ea.
--------------------	---------------------------------



The Rookie Kit

For basic cuts and bruises. Plastic case includes: bandages, gauze pads, antiseptic wipes, antibiotic ointment, sting wipes and 1/2" tape. Fanny Pack sold separately (14"W x 3"H).

18052 4.75"W x 3"H x 1.75"D	\$7.99 ea.
18048 Fanny Pack only	5.99 ea.

First Responder 50-Person First Aid Kit

All of the essential first aid supplies you would need in a medical emergency.

- 50 - .75" x 3" Adhesive plastic bandages
- 4 - 2" x 2" Gauze dressing pads
- 4 - 3" x 3" Gauze dressing pads
- 20 - 4" x 4" Gauze dressing pads
- 2 - 5" x 9" Trauma pads
- 8" x 10" Trauma pad
- Emergency pressure dressing
- 3 - 2" Conforming gauze roll bandages
- 3 - 36" Triangular sling/bandage w/ 2 safety pins
- 6 Alcohol pads • 3 - 3.5 gm. Burn relief packs
- 6 Povidone-iodine infection control wipes
- 2" x 5 yd. 3-cut first aid tape
- 4" x 5" Instant cold compress
- 2 Sterile eye pads
- 4oz Eye wash
- 10 gal. Biohazard bag
- 2 - 10" x 12" Ziplock bags
- Latex free CPR one-way valve face shield
- 52" x 84" Emergency blanket
- 2 pr. Exam quality vinyl gloves
- 7.25" Utility shears
- 3.5" Stainless steel deluxe tweezers
- First aid guide

18359 Measures 13.75" x 10.75" x 3"	\$132.50 ea.
--------------------------------------------------	---------------------



AEDS/PUBLIC SAFETY



The Powerheart G5 is the first FDA-cleared AED to combine fully automatic shock delivery, dual-language functionality, variable escalating energy, and fast shock times



Cardiac Science Powerheart G5 AED

The G5 is the only AED that notifies you 30 days prior to electrode and battery expiration!

Advanced Technology – Delivers patient customized post-CPR shock in as few as 10 seconds for effective therapy and enables quick transfer and review of data via USB.

Dual Language - Switch to an alternate language during a rescue with the push of a button (Available in English/Spanish)

RescueCoach - user-paced prompts guide users through each critical step of a rescue.

Rescue Ready Technology - Device self-checks all main AED components (battery, hardware, software, and pads) daily. Highly visible Rescue Ready indicator assures rescuers that they are retrieving a working AED.

Intellisense Technology - Enable the Powerheart G5 to be the only AED to test for presence and function, and have the intelligence to notify you 30 days prior to electrode and battery expiration.

Self Checks - Daily, weekly and monthly self-tests ensures that pads, battery and internal circuitry are always working.

Interchangeable Pads – Nonpolarized pads can be placed in either position on the chest (upper right or lower left) to reduce confusion

Durability – With an IP 55 rating the Powerheart G5 features a rugged, durable design for transport, storage and use in challenging settings. 8-year warranty and 4-year full replacement guarantee on Powerheart G5 AED Intellisense battery.

- 57779 Fully Automatic, Spanish/English, CPR feedback \$1,820.00 ea.
- 55723 Fully Automatic, Spanish/English 1,695.00 ea.
- 55721 Fully Automatic, English Only 1,695.00 ea.
- 55724 Semi Automatic, Spanish/English 1,695.00 ea.
- 55722 Semi Automatic, English Only 1,695.00 ea.



CPR Prompt Professional Training Manikins

Cleaning is quick and easy with unique single-use face-shield lung bags. Studies have shown that review and practice of lifesaving skills can significantly increase retention and better prepare rescuers. Now there is an affordable option for instructors to provide one manikin per student. CPR Prompt® Professional Training Manikins provide the same features and functions of traditional manikins at a fraction of the cost. Includes: 5 Adult/Child Manikins, 50 Adult/Child Lung Bags, use and care sheet and carrying case.

- 18383 Adult/Child 5-Pack - Blue Body \$576.50 pkg.
- 18384 Adult/Child 5-Pack - Tan Body 576.50 pkg.



CPR in Schools Training Kit™

Students learn the lifesaving skills of CPR in just one class period!

An easy-to-use kit designed specifically for the needs of schools that teaches AED and choking relief. The kit's wheeled bag allows for convenient movement from classroom to classroom and easy storage. It's also reusable – one kit can train hundreds of people.

Kit includes:

- One wheeled classroom carry bag
- 10 Mini Anne Plus inflatable manikins
- 10 individual carry bags
- One hand pump for manikin inflation
- Five practice-while-watching training DVDs
- One Facilitator Guide
- 10 AED training simulators
- Two mesh collection and storage bags
- 10 replacement airways
- 10 replacement face masks
- 50 manikin wipes
- One facilitator binder that contains the lesson plan, pre- and post-test, and additional supplementary material



School Health is the sole distributor of the CPR in School's Training Kit.

- 58951 \$649.00 kit

HYDRATION

Gatorade® Round Coolers

Get ready for the game! Keep your Gatorade cold for hours with the insulated Rubbermaid® design! Coolers come with tight-fitting screw-on lid, recessed "fast flow" faucet and handles for easy transportation.



- X18369 1-Gallon\$22.99 ea.
- X18370 3-Gallon 70.99 ea.
- X18371 5-Gallon 83.99 ea.
- X18372 7-Gallon \$106.99 ea.
- X18373 10-Gallon 126.99 ea.



Gatorade® Rectangular Ice Chests

Hold all of the ice and supplies you need for your sports program! Insulated Rubbermaid brand Gatorade Ice Chests have a tight-fitting, hinged seat-top lid, and a self-draining plug. The 60 qt. cooler has integrated wheels and telescoping pull handle allow for easy transportation.

- X18367 60-quart \$154.99 ea.
- X18368 48-quart 75.99 ea.



Gatorade® Cooler Carts

Made of lightweight but sturdy aluminum. Each cart is mounted with 4 heavy duty locking wheels and storage for cups, towels and more. Double Cooler Cart measures: 41"L x 18"W x 39"H. Single Cooler Cart measures: 22"L x 18"W x 37"H. Cooler and cups are sold separately.

- 18374 Double Cooler \$759.99 ea.
- 18375 Single Cooler 634.99 ea.



Gatorade® Bottles and Carrying Rack

Official Gatorade Carrier and bottles that are used in the NFL and the NBA! The original Gatorade squirt bottles have a large mouth for easy filling, contoured grips on bottle to help minimize the chance of dropping, and they are dishwasher safe. The Gatorade® Insulated Bottle features a contoured shape for non-slip grip control and a dual-layered wall to keep drinks cold. Gatorade Sports Bottle Carrier holds 6 32 oz Gatorade Squeeze Bottles at one time. These bottle carriers are perfect for any sports team in any league.

- 18360 Original Gatorade® 32 oz. Bottles Single \$4.99 ea.
- 18361 Original Gatorade® 32 oz. Bottles 100 Bottles 371.00 ea.
- 18363 Gatorade® Insulated Bottle 32 oz. 14.99 ea.
- 18364 Six Original Gatorade® 32 oz. Bottles plus Rack 49.99 ea.
- 18365 Bottle Rack Only 30.99 ea.

Hydration Station

Transport your coolers with this tough dolly! Constructed of 1" powder coated steel tubing with large 8" wheels for turf or smooth indoor surfaces. Equipped with a wire basket for cups. Can hold coolers from 5 to 20 gallons. Cooler not included.

- 18068 \$224.99 **SALE \$209.97 ea.**



Easy-Roll™ Cooler Cart

Front casters improve steering. The frame is made from heavy 1" galvanized steel with a 16" O.D. welded platform to support most coolers up to 10 gallons. The 10" all terrain pneumatic rear tires and front swivel casters allow ease of transport. Includes lower basket to hold supplies. Measures 53"H x 27"W x 26"D. Cooler and cups not included.

- X18091 \$334.99 ea.

Gatorade® Paper Cups

Sturdy waxed paper cup with rolled rim. These disposable waxed paper cups are multi-purpose and ideal for a variety of beverages, such as water, sodas and Gatorade. Perfect for serving beverages at meetings, field events and social gatherings. Each case has 2,000 paper cups with Gatorade logo.

- 18376 12 oz. 2000/case \$162.50 cs.
- 18377 9 oz. 2000/case 110.00 cs.



HYDRATION



Waterboy™ Hydration Systems

Easy to transport and is ready when you are.

The 23-gallon, fully mobile hydration system can re-hydrate up to 6 athletes simultaneously. The on-board, battery-operated, on-demand pump provides plenty of pressure for several hours. On a 2-wheel dolly, with FLAT FREE wheels. The Horizontal Chiller, is equipped with an ice chest that houses the chiller coils you cover with ice and chills the water as it runs through the pipes. 8 direct hydration nozzles with FDA-approved beverage spouts equipped with anti-microbial-treated safety spouts.

- X18378 Vertical Power Model - 23 Gallon \$2,234.99 ea.
- X18379 Horizontal Chiller - 25 Gallon 1,558.00 ea.



Cramer® PowerFlo Pro - 20 Gallon
Square tank provides for easy mobility and access through narrow doorways.

- Convenient battery charging system
- FDA approved material
- Rugged metal hand truck
- External manifold to facilitate easier cleaning and winterizing
- Six drinking stations with flexible hoses
- The rounded corners allow for easy cleaning
- 10" no flat wheels

X18381 20 Gal Tank \$1,819.99 ea.



Carbon filter
water purifier

Battery packs

Convenient storage shelf
protects batteries from direct sunlight

..... No flat tires

PurePumper 1600 – 16 Gallon

Designed to offer a smaller mobile space saving unit that can be moved very easily. The Pure Pumpers 16-gallon dolly unit that is engineered for maneuverability on turf or grass that can be pushed or pulled with little effort. It is powered by 2 lithium ion 18 volt batteries that can be easily removed for recharging. It comes with a carbon filter that eliminates taste, color and smell from the water. Wide mouth opening allows for easy filling and cleaning while a bottom sump drain allows for complete water drainage after use.

X18380 \$1,664.99 ea.



SIMPLY REPLACE YOUR EXISTING LID WITH BOSS LID SYSTEM!

Outdoor Boss Drinking Station

Use your own 7 or 10 gallon twist top coolers!

- 12 Volt Self-Contained Drinking System – Auto Shut-off
- The patented BOSS is a completely self-contained, easy to transport, and affordable way to re-hydrate athletes
- Auto-sensing, pressure activated pump shuts off when not in use
- The system comes complete with four drinking lines
- Fits 10 or 7 gallon twist top coolers, and includes smart trickle charger
- Water intake is part of the lid allowing you to purchase the drinker only
- Each system features 4 drinking stations

- X18382 Lid Assembly Only \$734.99 ea.
- X18398 Lid Assembly with 10 Gallon Cooler..... 819.99 ea.
- X18399 Collapsible Cart..... 94.99 ea.



WHISTLES

ZONE Whistles

Innovative air stream design!

Pealess for no clogging. Ensures a penetrating high frequency trill. Sold in assorted or solid color sets of six, with or without lanyards. Black whistles sold in sets of 6 or individually, with or without lanyards.

Description	Red	Orange	Yellow	Green	Blue	Purple	Black	Set of 6	SALE
No Lanyard	47210	47211	47212	47213	47214	47215	47216	\$14.99	\$7.97
With Lanyard	47217	47218	47219	47220	47221	47222	47223	19.13	11.97

47224 SET OF 6 No Lanyard \$17.50 **SALE \$9.37 set**
 47225 SET OF 6 With Lanyard 22.50 **SALE 13.97 set**

FOX 40 PEARL

Excellent all purpose whistle!

The two chamber pealess design provides a lower, loud tone.

Red	Orange	Yellow	Green	Blue	White
47187	47185	47186	47184	47183	47188

Specify Color \$2.69 ea.
 47189 Set of 6 Assorted Colors 15.99 set

FOX 40 CLASSIC
CLASSIC SIZE

Designed without a pea!

Made with 3 harmonically tuned air chambers that create an extra loud tone that cuts through crowd noise.

Red	Orange	Yellow	Green	Blue	Black	White
47125	47121	47122	47123	47124	47105	47127

Specify Color \$5.59 ea.
 47191 Set of 7 Assorted Colors 36.99 set

FOX 40 CUSHIONED
OFFICIAL SIZE

Best whistle in the industry.

Made with 3 harmonically tuned air chambers that create an extra loud tone. Designed without a pea, these whistles will not stick and have a longer life. Features a cushioned mouth grip and includes a lanyard.

Red	Orange	Yellow	Green	Blue	Black	White
47145	47146	47147	47148	47149	47151	47152

Specify Color \$6.99 ea.
 47190 Set of 7 Assorted Colors 45.99 set



Acme Thunderer Plastic Whistle

The plastic version of the famous Acme metal.

A solid compression molded, providing maximum resonance and strength.

47029 \$34.99 dz.



Champion Whistles

Ideal for bulk purchases!

Have an event and need a lot of whistles? Great working whistles, your choice of metal or plastic. Available in eaches or dozens.

47012 Medium Weight Plastic ... \$ 0.79 ea. 47031 Medium Weight Plastic ... \$6.99 dz.
 47010 Medium Weight Metal 0.79 ea. 47030 Medium Weight Metal 6.99 dz.
 47057 Heavy Weight Metal 1.59 ea. 47081 Heavy Weight Metal 17.99 dz.



ZONE Squeeze Whistles

Significantly more hygienic than traditional whistles!

Squeeze the bulb to produce a high pitch, loud whistle noise! Ideal for volunteer use, easy to create rapid blows and can be attached to a tether or lanyard. Measures 4.75" tall. Super loud!

47054 SET OF 6 \$59.99 set
 47055 Assorted Colors 9.99 ea.



Electronic Whistles

Press the button for a loud whistle blast!

Sanitary for multiple users, includes adjustable wrist strap. Contoured to fit your hand whistles includes a wrist lanyard and is designed with an easy grip push button. Include batteries.

47194 Fox 40: Red, 3 different tones \$17.99 ea.
 47004 Single Tone- Orange/Black 19.99 ea.
 47005 Three Tone- Gray/Black 20.99 ea.

CLIPBOARDS



Scorebooks

Detailed and season-long for compiling statistics. Easy to use, hard cover and quality spiral binding. Contains pages for full season of games or meets.

- 51004 Palos Sports Basketball 20 players / 31 games plus stats \$5.99 ea.
- 51006 Palos Sports Baseball 18 players / 30 games plus stats 5.99 ea.
- 51007 Palos Sports Volleyball 26 matches, summary, more 5.99 ea.
- 51003 Mark V Basketball 30 games, plus index for reference 6.99 ea.
- 51008 NFHS Baseball/Softball..... 13.99 ea.
- 51009 NFHS Basketball..... 13.99 ea.
- 51012 NFHS Soccer 13.99 ea.
- 51002 NFHS Volleyball 13.99 ea.
- 51015 NFHS Wrestling 13.99 ea.



Colored Clipboards

Organize your teams, classes and more!

Made from impact resistant plastic with a metal clip. Measures 12 1/4" L x 8 7/8" W. Sold in a set of six, one of each color.

- 47050 SET OF 6 \$32.99 set

Lanyards

Available in 8 colors!

Sturdy 18" L nylon lanyards with swivel snap clips to hold whistles, key rings, I.D. badges and more.

Black	Red	White	Royal	Green	Gold	Orange	Purple	Price
47107	47108	47109	47110	47111	47112	47100	47101	\$0.69 ea.
47038	47039	47040	47041	47042	47043	47044	47045	6.99 dz.



Neon Lanyards

Bright neon colors.

Brighten up your school leaders with these cool looking neon colored 18" L lanyards. Dozen packs only 2 each; blue, pink, yellow, orange, purple and green. 47144 \$6.99 SALE \$5.97 dz.



Referee Shirts

Full cut V-Neck Shirts with a hemmed bottom. A high quality referee shirt in Men's sizes.

- 65353 Adult Large \$29.99 ea.
- 65354 Adult X-Large..... 29.99 ea.
- 65355 Adult XX-Large 29.99 ea.



Standard Clipboard

Old fashion style!

Pressed board with steel spring clip. Keeps paper in place and allows for a smooth writing surface. Measures 9" W x 15" L.

- 47026 \$3.99 ea.



47059 Baseball



47047 Football

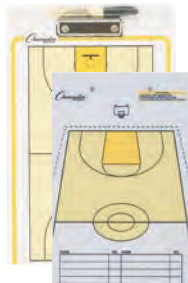

47118 Basketball



47048 Soccer

47046 Volleyball



Coaches Playboards

Dry erase double sided clip/play boards!

10" x 16" colored boards with full field on one side and half court on the other. Please specify sport: baseball, football, basketball, soccer or volleyball. Includes 1 dry erase pen.

- Specify Sport \$12.99 ea.

MEGAPHONES



Champion Sports Megaphones

Feature packed megaphones at budget friendly prices.

These indoor/outdoor use megaphones help to provide clear and effective long distance communication for stadiums, team practice, and large crowds. Also ideal for giving instructions and directions during events or emergencies. Built in siren with an adjustable volume. Units are battery operated (not included).

- 47226 A- 1000 yd., 12 - 25 watts, 60 sec. recording, 8 C batteries..... \$109.99 ea.
- 47227 B- 800 yd., 8 - 12 watts, 8 AA batteries..... 66.99 ea.
- 47228 C- 300 yd., 3-6 watts, siren-speak-music, compact, 4 D batteries..... 16.99 ea.

- 47070 D- 1000 yards, 30 watts w/ alarm & microphone 8 C batteries... \$89.99 **SALE \$79.97 ea.**
- 47097 E- 1000 yards, 25 watts w/ alarm, 8 C batteries 81.99 **SALE 73.97 ea.**
- 47071 F- 600 yards, 10 watts w/ volume control, 8 AA batteries 68.99 ea.
- 47096 G- 400 yards, 8 watts w/ alarm, 6 AA batteries 39.99 ea.



Charge & Go Megaphones

Use rechargeable Lithium-ion battery pack or standard batteries!

A fully charged battery will provide 8 hours of typical operation. Made from durable ABS plastic construction with a comfortable pistol grip and wrist strap. Both styles feature adjustable volume, talk and siren modes.

- 47192 Mity-Meg: 900 yards & whistle mode..... \$174.99 ea.
- 47193 Mini-Meg: 100 yards..... 119.99 ea.

120 Watt Pull-N-Go All-in-One™ System

Compact, everything you need!

A wireless PA system with 20AH rechargeable batteries in a portable self-contained PA system containing a retractable dolly, a vibration resistant CD player, a dual-channel wireless microphone system, a built-in amplifier and a speaker. Includes a handheld microphone, a belt-pack wireless transmitter, a headset microphone and a lavalier microphone. AUX input and output connectors are provided to be used with any other PA or audio system. The combination of the built-in amplifier and the speaker provides 120W maximum power output. Includes cover.

- 53045.....\$699.99 ea.

PROTECT YOUR MEGAPHONE!

Megaphone Bag

Comes with carrying handle. Protect your megaphone with this 14" x 9" nylon/polyester bag. Megaphone sold separately. Red only. 47098.....\$18.99 ea.



Waist Band PA Amplifier

Easy to use portable sound system! Comes with a with a headset microphone and carry bag. 7 Watt power from 8 AA batteries. Belt is 44" long. Batteries are not included. 53037.....\$39.99 ea.

WETLINE FIELD MARKERS



Aerosol Field Stripping Machines

Uses aerosol cans.

Heavy duty line markers for grass or dirt fields.

Sturdy steel construction with 10" easy rolling wheels. Lightweight housing includes windscreen, fingertip on/off lever, and a simple 2"-4" line width adjustment. Non-toxic aerosol spray goes straight downward for complete coverage. Maintenance free, no messy clean up, won't harm grass.

Available with extra storage for 6 or 12 cans.

X54023 Machine w/6 Can Storage \$134.99 ea.

X54026 Machine w/12 Can Storage 139.99 ea.



Champion Dry Line Marker

All steel construction.

Adjustable to 2 and 4 inches.

Unit has a guide strip on top of the hinged cover lid to maintain straight lines. ABS plastic agitator for even flow. Covered to keep marking compound dry. Four wheels on steel axles for smooth roll.

54042 35 lb. capacity \$159.99 ea.



Closed Measuring Tapes

Imprinted in both inches and metric scale.

Will not shrink or rust, will not break if twisted or stepped on. Tape made of fiberglass enclosed in a hard plastic casing with easy grip handle.

42045 50ft/15m \$6.49 ea.

42046 100ft/30m 9.49 ea.

42047 165ft/50m 13.99 ea.



42048 200ft/60m \$15.99 ea.

42049 250ft/75m 21.99 ea.

Open Measuring Tapes

Imprinted in both inches and metric scale.

Will not shrink or rust, will not break if twisted or stepped on. Tape made of fiberglass wound on a hard plastic casing with top handle. Quick wind metal handle on side.

42050 100ft/30m \$11.99 ea.

42051 165ft/50m 13.99 ea.

42052 200ft/60m 17.99 ea.



42053 300ft/90m \$23.99 ea.

42067 330ft/100m 25.99 ea.

42068 400ft/120m 28.99 ea.

UNIVERSAL TIP WORKS WITH ALL MACHINES!



Aerosol Cans

Provides a 2"-4" line with sharply defined edge!

Non-clogging, water resistant paint. New universal tip will work with all machines (including Fox Valley) and marking wands. No lead or CFC's and very low VOC level. 20 fl. oz. disposable cans provide approximately 135 yards of 4" stripe per can. Certain colors are sold individually or in a case of 12.



Scarlet	Royal	Maroon	Purple	Navy	Black	Pink	White	Orange	Yellow	Price
54016	54017	54018	54019	54020	54021	54032	54270	54271	54272	\$57.99 cs.



Aerosol Marking Chalk

Bright white for turf, grass, pavement or gravel.

Marking chalk for synthetic turf and ideal for temporary marking as well. Water based, non-clogging and non-flammable. Safe to use on most surfaces and easily removed by pressure washing. Universal tip works in all stripping machines and marking wands. 20 oz. disposable can.

54329 Case of 12 69.99 cs.

Hand Wand Unit

A fast easy way to touch up fields.

Make a batters box, mark playgrounds for assemblies or use anywhere small areas need to be marked. This lightweight marker has a pull lever on the handle that releases the paint from the inserted paint cartridge stored below.

54029 \$40.99 ea.



6" Measure Marker™

Measuring wheel and paint marking system!

- Pistol grip with trigger releases paint on target
- Dual 6" wheels w/Non-slip tread for added stability
- 5 digit counter measures up to 10,000 ft
- Uses standard inverted aerosol paint cans

54014 \$79.99 ea.



Big Yellow 10" Measuring Wheel

5 digit counter reads to 10,000 units!

- Pistol grip with twist and lock adjustable handle.
- Non-slip tread
- Magnifying lens for improved readability
- Gear driven counter w/push button reset, counts up to 10,000 ft

54012 \$63.99 ea.



MESH BAGS



ZONE Standard-MESH™ Duffel Bags

Color coordinate all your colored items!

Lightweight, breathable and durable 15" x 36" equipment bags. Full length zipper with carrying handle. The mesh allows you to see contents and aids ventilation. Sold in a set of six or individually.

36117 SET OF 6 \$59.90 **SALE \$51.97 set**

SIZE	RED	ORANGE	YELLOW	GREEN	BLUE	PURPLE	PRICE
15"x36"	36201	36202	36204	36203	36205	36206	\$9.99 ea.

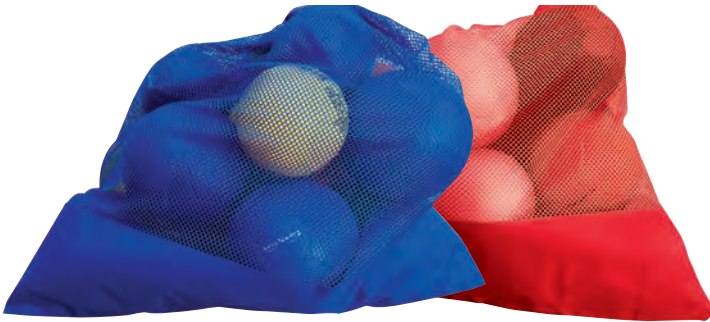

REINFORCED CANVAS BOTTOM!

ZONE Premium Mesh Bags

Reinforced bottom for tough use!

Avoid excessive wear, tears and rips on your mesh bags! These bags have strong seams, premium mesh and a drawstring closure. Bags measure 32"W x 36"L and are available in 2 colors.

36121 Blue \$13.99 ea.
36001 Red \$13.99 ea.



Standard MESH Bags

An excellent economically priced mesh bag.

Our #1 selling bag for the last 15 years.

Sort balls, vests, jump ropes or almost anything with these mesh bags. The durable 100% polyester mesh with small holes and drawstring is a favorite of many PE teachers and recreation directors. Sold in set of 6 or individually .

36073 SET OF 6 12" x 18" \$24.99 **SALE \$18.97 set**
36115 SET OF 6 24" x 36" 23.90 **SALE 19.97 set**
36116 SET OF 6 36" x 45" 35.90 **SALE 29.97 set**

SIZE	RED	ORANGE	YELLOW	GREEN	BLUE	PURPLE	PRICE
24"x36"	36125	36137	36122	36123	36124	36138	\$3.99 ea.
36"x45"	36229	36227	36226	36225	36230	36228	5.99 ea.



ZONE ULTRA-MESH™ Shoulder Bags

The same heavyweight mesh as our heavy mesh scrimmage vests!

Tough polyester mesh with reinforced seams for extra durability, shoulder strap for ease of transport, improved closure clip and 3" x 5" canvas ID tag for easy identifying. Measures 24" x 36". Sold in set of 6 or individually.

36189 SET OF 6 \$53.90 **SALE \$48.97 set**

SIZE	RED	ORANGE	YELLOW	GREEN	BLUE	PURPLE	BLACK	PRICE
24"x36"	36184	36186	36190	36196	36197	36198	36199	\$8.99 ea.



Standard-MESH Tote Bags

The bag of many uses.

It's super strong and holds balls, uniforms, shoes, etc. The 1/4" hole openings not only allow you to see what's in the bag, it allows air to circulate drying out any damp items. Easy clip closure cord lock.

Available in a variety of sizes.

36112 15" x 20" White \$2.99 ea.
36113 24" x 36" White 3.99 ea.
36109 24" x 36" Black 4.59 ea.
36114 24" x 48" White 4.59 ea.
36224 36" x 45" Black 6.89 ea.

EQUIPMENT BAGS



NEW

ZONE Duffel Bag

A mesh/canvas combo for easily identifying equipment.

This bag can hold at least (40) 8" rubber balls. It is made of canvas with a vinyl backing for strength and a strong porthole mesh middle section. Features include a drawstring top and heavy duty shoulder strap. Measures 42" L x 20" W.

- 36288 SET OF 6 \$89.99 set
- 36270 Single Red/Black Bag 15.99 ea.



Heavyweight All Purpose Bag

Premium quality PU coated 600 denier polyester.

Designed to hold anything from basketballs to baseball equipment. Sturdy enough to handle heavier items. Full zipper closure with full wrap-around handles for additional support. Black only, measures 36" L x 16" W x 16" H.

- 36210 \$22.99 SALE \$18.97 ea.

HOLDS 40



Jumbo Duffel Bag

Holds up to 10 basketballs or 20 footballs!

Throw it all in here and go! Reinforced bottom, vinyl sides and mesh top with adjustable shoulder strap. Measures 41" H x 15" W x 15" D.

- 36235 \$21.99 ea.



Mesh Hockey Stick Bag

Oversized to fit most sticks!

Made from polyester mesh with heavy duty nylon web handles, shoulder strap and zippered closure. Blue only. Measures 60" L x 20" W.

- 36049 \$17.99 ea.



ZONE Soccer Ball Bag

Holds up to 10 balls!

Nylon construction with mesh insert panels, reinforced bottom, drawstring closure and nylon web shoulder strap. Measures 24" high with 21" diameter.

- 36090 \$14.99 ea.
- 66728 3 Bag Pack 30.99 pk.



ZONE Sport Duffel Bag

Holds up to 12 soccer balls!

Made with thick mesh ventilation panels and reinforced heavy nylon sides, bottom and top. Adjustable web shoulder strap and drawstring closure. Measures 32" high with an 18" diameter.

- 36083 \$12.99 ea.
- 66729 3 Bag Pack 36.99 pk.

BALL STORAGE



ZONE Roll Bag

A true multi-purpose bag on wheels!

Made from heavy duty polyester nylon with reinforced seams and sturdy zippers. Multiple outside pockets for small items. Easy roll wheels and stout straps for carrying. Rigid internal fiber side panels for shape retention. Measures 38" L x 18" W x 16" H.

16579 \$48.99 **SALE \$39.99 ea.**



Jumbo All Purpose Bag on Wheels

Plastic furniture wheels allow for easy transport!

Bag is made of extra heavy duty 600D polyester fabric to prevent rips. Side pockets for extra storage.

Stores up to 8 basketballs. Black only. Measures 38" L x 18" W x 16" H.

36110 \$64.99 ea.



Track Wagon
Ideal for track or other outdoor equipment!

Heavy duty steel mesh deck with powder coat finish with large straight pull handle with padded grip. Fold down and removable sides for easy loading and unloading. Large, 13" pneumatic treaded tires. Measures 34" L x 18" W x 21.75" H with a 400 lb. weight capacity.

X42175 \$149.99 ea.



HEAVY DUTY

Folding Wagon

The original folding wagon!

Made with a strong steel frame, swivel handle, 8" tires and 600 denier heavy duty polyester fabric lining, this wagon will support up to 150 lbs. Measures 36" L x 22" W x 25.5" H. Weighs 25 lbs.

X36077 \$129.99 ea.



Folding Utility Cart

Easy to move indoors or outside!

Built tough with a powder coated steel frame and a non-woven liner. 4" front and 9" rear swivel rubber casters for easy maneuverability. Weighs 12 lbs. Measures 21" W x 25" D x 40" H; maximum cart weight capacity is 110 lbs.

X36278 \$49.99 ea.



HOLDS **25**

Portable Ball Cage

An excellent budget minded ball cart.

Simple, affordable and easy to assemble. All steel construction with chrome finish and 4 easy rolling non-marring casters. No tools needed to assemble. Measures 41" L x 23" W x 33" H.

X36171 \$169.99 ea.

BALL STORAGE



HOLDS 35

Pro Style Ball Cart

Top of the line quality!

Heavy duty 1" OD powder coated frame with 4 tier rack for up to 35 balls. Easy access from both sides for speed drills. Smooth, non marring 4" locking wheels. Measures 51"L x 18.5"W x 54"H, weighs 44 lbs.

X36024 \$219.99 ea.



HOLDS 48

48 Ball Super Cart

4 tiers, 8 rows.

Double wide rack made with 1" chrome plated steel tubing that holds 6 balls each. Includes 3" swivel casters. Measures 55.5"L x 24"W x 46.5"H.

X36038 \$249.99 ea.



HOLDS 15

Triangle Ball Cart

Wide base prevents tipping!

Made from heavy duty chromed steel with non marring swivel casters. Solid triangular frame provides additional strength and stability. Wide base prevents tipping. Holds 15 basketballs. Measures 26"L x 28"W x 46"H.

X36039 \$99.99 ea.

3 YEAR GUARANTEE



HOLDS 12

Basketball Carrier

This rugged and stable carrier is the most durable on the market today.

The wide stance prevents tipping, along with 4 heavy duty swivel casters makes it easy to move. All welded 15/16" O.D. steel side frames and 1" O.D. steel crossbars provide excellent durability.

36151 12 Ball Carrier - 24"W x 36"L \$124.99 ea.

36142 18 Ball Carrier - 32"W x 60"L 149.99 ea.



36126

36127

Traditional Rolling Ball Caddie

Holds 12 or 16 basketballs.

Made with 1" 16 gauge galvanized steel tube end frames and 3/4" 16 gauge side rails to withstand years of hard abuse. Four rubber casters for easy mobility.

36126 12 Ball Cart-3 Tier, 41"H x 41"L x 17"W \$59.99 ea.

36127 16 Ball Cart-4 Tier, 53"H x 41"L x 17"W 67.99 ea.

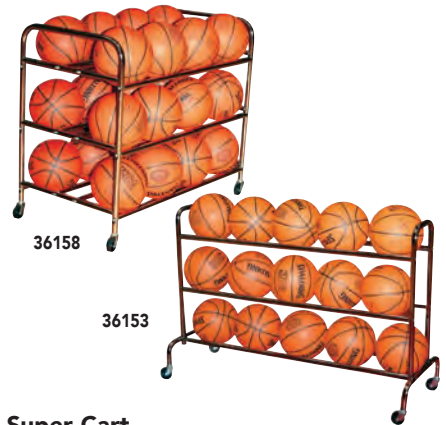

36158

36153

Super Cart

Extra heavy construction, available in either 15 or 24 basketball holder.

Super strong 1" plated steel tubing with non-marring casters to allow easy transport. Wide base design makes it harder to tip over.

X36153 15 Ball Cart 50"L x 17"W x 34"H..... \$149.99 ea.

X36158 24 Ball Cart 40"L x 22"W x 34"H..... 169.99 ea.



All Terrain Large Equipment Cart

For extremely heavy use.

Large, 10" pneumatic tires will navigate the roughest of outdoor terrain. Built from thick gauge galvanized steel with a wire mesh body and easy to pull handle. Lid can be locked for security. Measures 51"L x 24"W x 41"H; weighs 103 lbs. Made in the USA. Lifetime Warranty! Ships by truck.

T36078 \$649.99 ea.

Wall Mounted Ball Locker

Keep organized and save valuable storage space!

Load the balls from the top and dispense them from the bottom. The Single Unit holds 6 basketballs. The Double Unit is great for basketballs, volleyballs, soccer balls and playground balls. Each side will hold 7 basketballs or 9 volleyballs. Constructed of 1" galvanized steel tubing with steel plate backstays. Locks for security. Mounting hardware not included.

X36006 Single Unit-12"W x 66"H x 15"D..... \$99.99 ea.

X36007 Double Unit-28"W x 61"H x 14"D..... 209.99 ea.



BALL LOCKERS

HOLDS **25** 



2 7/8" SWIVEL CASTERS FOR SMOOTH TRANSPORT

ZONE Ball Cart™

Holds 25 basketballs!

Made with a powder coated 1" tubular steel frame and 3/8" steel wire. Equipped with sturdy 2 7/8" swivel casters for smooth transport. Hinge lid closure for ease of opening and closing. Can be locked easily with a small chain and lock or use a long shackled lock (not included). Some assembly required. Measures 48"L x 24"W x 35.75"H.

X29001\$204.99 **SALE \$169.97 ea.**



HOLDS **10** 

HOLDS **20** 

SecurityYELLOW™ Locking Ball Storage Carts

Bright yellow powder coat finish!

The large cart holds approximately 20 basketballs, playground balls, volleyballs or soccer balls. All steel construction of 1" diameter steel with 2" ball bearing casters with rubber wheels. Heavy duty powder coat finish resists nicks and rust. Available in 2 sizes. Some assembly required.

X36170 27"L x 29"W x 30"H; weighs 53 lbs.\$269.99 ea.

X36169 42"L x 24"W x 30"H; weighs 57 lbs.299.99 ea.



Ultimate Pro Ball Locker

HOLDS **30** 

Can be locked for total security!

Holds up to 30 balls! Constructed of 1" galvanized steel tubing with heavy duty welds. Rolls smooth on hard rubber casters that will not mar floors. Quick and easy 10 minute assembly. Measures 42"L x 24"W x 28"H. Ships UPS in 2 cartons.

X36240\$234.99 ea.



HOLDS **28** 

Extreme Ball Locker

Lockable hinged lid.

Holding up to 28 balls, this locker is constructed from 1" powder coated steel tubing with swivel caster front wheels and large 8" rear wheels for easy mobility. Measures 45"L x 24"W x 38"H. Weighs 62 lbs.

X36080\$269.99 ea.



HOLDS **20** 

Compact Ball Locker

Holds up to 20 basketballs!

Built tough from 1" heavy duty powder coated steel tubing with oversize rear wheels and non marring smooth swivel casters. Can be locked-lock not included. Includes mesh ball bag. Weighs 42 lbs; Measures 46"H x 26"W x 28"D. Some assembly required.

X36029\$201.99 ea.

TOTEMASTER®

ALL THE GREAT
FEATURES OF THE
ORIGINAL
TOTEMASTER
IN A MINI SIZE!

HOLDS **10** 

Mini Totemaster™ TE-30
Lockable equipment carts!

An ideal ball locker for programs that do not require a full size cart. Overall size is 37" H x 21" W x 21" L. Weighs 25lbs.

X36188 \$159.99 ea.



ToteMaster™ TE-2 All Steel Ball Locker HOLDS **30** 

The most popular lockable style equipment cart available. Made from 3/4" steel welded construction with powder coated and hinged locking cover. Non-marking swivel wheels for easy rolling and steering. Just pop open, put on the wheels and assembly is complete. Measures 3' L x 2' W x 3' H and weighs 48lbs. Available in blue or black.
X36165 Blue..... \$189.99 ea.
X36286 Black..... 189.99 ea.

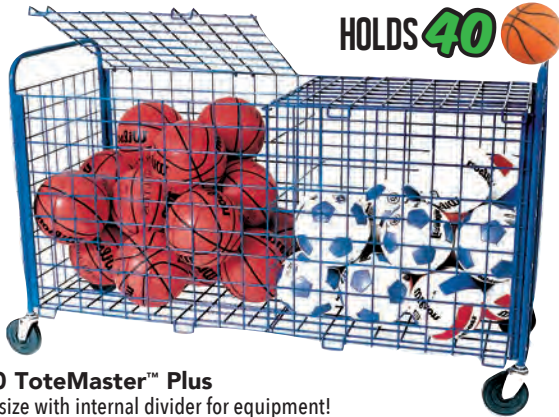

HOLDS **40** 

TE-60 Totemaster™ Plus

Larger size with internal divider for equipment!

Same rugged construction of the TE-2 Totemaster- just bigger! Includes 3/16" all welded steel powder coated wire with 3" square mesh and upgraded swivel wheels. Split top for each compartment, can be locked for secure storage. Unit can hold about 40 basketballs total. Measures 5' L x 2' W x 3' H and weighs 96 lbs. Ships UPS oversize.

X36166..... \$303.99 ea.

HOLDS **20** 

ToteMaster™ AT-5 All-Terrain Ball Cart

Can roll it almost anywhere.

Full size, can hold up to 20 basketballs, soccer balls, or playground balls. Small steel mesh construction. Two large all-terrain 12" back wheels with front swivel wheels for easy rolling and steering. All steel welded construction with hinged cover. Blue powder coat finish. Some assembly required. 36" L x 24" W x 36" H, weighs 48 lbs.
X36223 \$279.99 ea.



ToteMaster™ AT-10 All-Terrain Field Cart

Provides 10" of ground clearance!

For those extreme surfaces! Provides large holding capacity for all types of equipment. Features welded steel mesh construction with a powder coat finish. Includes 6" semi-pneumatic front casters and 20" semi-pneumatic all terrain rear wheels. Lockable hinged cover. Some assembly required.

X36276 Measures 51" L x 25" W x 48" H and weighs 65 lbs. \$359.99 ea.

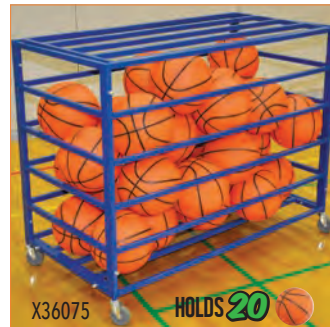

X36075

HOLDS **20** 



HOLDS **28** 

X36076

ToteMaster™ Ball Carriers

Strong enough to hold medicine balls!

Made from thick walled, 1" steel tubing with a durable powder coat finish, non-marking swivel casters and locking covers. Atlas™ model measures 47" L x 24" W x 37" H and will hold up to 20 basketballs. Locker & Hamper model measures 45" L x 24" W x 35" H and will hold up to 28 basketballs.

X36075 Atlas™: weighs 75 lbs. \$344.99 ea.

X36076 Locker & Hamper: weighs 60 lbs. 369.99 ea.



X36076

LOCKER & HAMPER MODEL
DOUBLES AS LINEN STORAGE WITH
SUPPLIED MESH LINER!

SPECIALTY CARRIERS

Equipment Cart

The ideal cart for PE!

- Holds up to 32 basketballs or 40 playground balls
- Holds over 150 jump ropes and 48 hoops
- Made from heavy duty structural plastic
- Has 3" swivel casters that are safe for floors
- Measures 49"L x 19"W x 56"H; weighs 45 lbs.

X36027\$219.99 **SALE \$209.97 ea.**



All Terrain Heavy Duty Cart

Great for PE or recess!

- Ideal for uneven surfaces
- Stores up to 24 balls
- Hooks for jump ropes & hoops
- Impact resistant baskets for smaller items measure 9.25"L x 13.25"W x 10"H
- Cart Measures 45"L x 19"W x 56"H; weighs 48 lbs.
- Made from structural grade plastic
- Non marring heavy duty wheels and swivel casters

X36026\$299.99 **SALE \$264.97 ea.**



Basket Cart

Back by popular demand!

This versatile cart includes large laundry style baskets for smaller items. Ideal for bowling pins, small balls, multiple fitness stations and more. Baskets measure 27"L x 18"W x 12"H. Cart is made from impact resistant PVC, assembles in minutes and includes 3" locking swivel casters. Cart measures 41"L x 24"W x 52"H.

X36103\$289.99 ea.



Plastic Buckets

Multi-purpose storage buckets!

Ideal for bean bags, rubber or plastic balls, fleece balls and more! A high density polyethylene constructed 5 gallon multi-purpose bucket.

- 36041 Red Bucket: no lid \$11.99 ea.
- 36043 Blue Bucket: no lid 11.99 ea.
- 36042 Yellow Bucket with lid 13.99 ea.

36277



Shield® Storage Bins

Almost indestructible corrugated, plastic containers.

Easily store and move your equipment with these strong, colorful bins. They're perfect for balls, pucks, pinnies and more. They will last for years. Choose a set of 6 (18.5") bins in rainbow colors or a set of 4 (3 sizes) in red and blue – 2 each. Lids are available for the 18.5" bins.

- X36272 18.5"L x 13.25"W x 12"H - Set of 4 \$89.99 set
- X36273 24"L x 17.5"W x 13"H - Set of 4 149.99 set
- X36274 28"L x 21"W x 12"H - Set of 4 159.99 set
- X36277 Set of 6 - 18.5" L x 13.25"W x 12"H 129.99 set
- X36295 Set of 6 - Small Bin Lids (for 36277) **NEW** 58.99 set



Shield® Deluxe Storage Bins & Lids

Holds over 100 lbs. of gear!

Stackable, with a built-in handle and drainage holes, these heavy-duty bins offer more versatility than standard bins. Can be used for games, stations and color coded activities. Set of 6 bins and lids, multi-colored. 16 gallon capacity. Made from high density polyethylene. Measures 15.75"W x 18.75"L x 15.5"H.

X36287 SET OF 6 \$212.99 set

ELECTRIC INFLATORS

Mikasa M80 Inflator

With suction cup base to prevent tipping. Compact design with 1/8HP motor that provides 100 PSI. Includes pressure gauge, reinforced flexible hose, needle and valve adapters. 120 AC operation.

44041 \$149.99 ea.



QUIET!

Electric Inflator

Fast and quiet. Heavy duty 1/4 HP air compressor delivers up to 60 PSI. Absorbs vibration with suction feet and padded handle. Includes gauge, safety control and coiled hose. 110 volts AC.

44020 \$129.99 ea.



#1 SELLER

Electric Air Pump

An excellent priced 1/4 hp oil-less air pump for medium to light use. Our #1 seller. Excellent for school programs inflating and maintaining proper air pressure for playground balls, soccer balls, volleyballs, etc. Includes an assortment of valve adapters. 100 volts, AC rated to 20 PSI.

44005 \$87.99 ea.



120 Volt Inflator

2-Year guarantee. All new state of the art design. Excellent for fast and reliable inflation of all types of inflatables. Features include: built-in pressure gauge rates to 200 PSI, 10' power cord, inflation accessories, 32" air hose, and plugs into any standard outlet.

44003 \$74.99 ea.



HIGH VOLUME INFLATORS



Deluxe Inflator/Deflator

Pumps air 85,000 feet per minute. Includes 6' flexible air hose and two adapters. A must for cageballs or any of your larger balls.

44016 \$212.99 ea.



Big Ball Inflator

Inflates/deflates larger balls in minutes. Take the work out of inflating or deflating cage balls, Gymnic® balls, pool toys or any ball that has a push-in valve. Comes complete with easy to use adapter and plugs into any 110v socket.

44001 \$76.99 ea.



Heavy Duty Inflator

Quickly inflates large valve balls from KinBalls to beach balls! This 4.5 horse power electric inflator includes a filter that helps avoid dust getting into the bladder during inflation. Includes 3 adaptors for a variety of balls.

10305 \$269.99 ea.

HAND INFLATORS

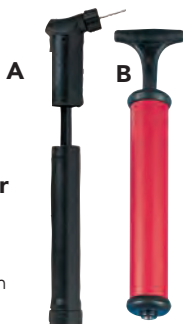

Cylinder Pumps

Economy pumps. Basic is an all plastic 10" pumps with flexible hose. D-Action pumps air when you push and pull (2x as fast).

44017 A. D-Action \$5.99 ea.

44018 B. Basic 3.50 ea.

High Volume Double Action Hand Pump

Great for large inflatable items! Double action high volume pump inflates air on up and down strokes. Inflate items in half the time! Perfect for cageballs or any larger ball. Includes large hose and valve adapter.

44011 \$22.99 ea.



Ball Doctor®

Repairs 128 balls! Seals leaks and punctures in all valve inflatable balls without bladders. Deflate ball, insert syringe, depress plunger, inflate ball and bounce vigorously.

44008 \$35.99 ea.



Inflating Needles

Steel inflating needles. Sold in pack of a dozen.

44024 \$2.99 doz.



Air Gauge

Air pressure gauge to ensure correct inflation.

44015 \$12.99 ea.

AUDIO



Hamilton Buhl® VENU100A PA System

Delivering a powerful amplifier with built-in rechargeable batteries. Unit includes a Bluetooth® receiver, DVD/VCD/MP3/CD-R/RW player, telescoping handle and easy-glide rubber casters. Choose with or without travel bag. Dimensions: 20.3" x 14.6" x 13.5". Weight: 37.5 lbs.

Features:

- Power Output: 60W • (1) 10" Woofer Speaker • (1) 1" Tweeter • Rechargeable Batteries: (2) 12V 7Ah • Distortion: 1% at 10W • Frequency Response: 80Hz-15KHz ±3dB • Input: Wireless/Wired Mic In, Line In • Output: Line/Video Out • (2) Wireless Microphones • (1) Remote Control • (1) AC Adapter & (4) AA Batteries

- 53558 VENU100A \$899.99 ea.
 54343 VENU100A with Canvas Travel Bag 1,079.99 set
 54345 Replacement Wireless Mic., Frequency 918.7 MHz 89.99 ea



120 Watt Pull-N-Go All-in-One™ System
 Compatible with most iPods® with 3.5mm in-line jack.

A wireless PA system with rechargeable batteries in a portable self-contained PA system containing a retractable dolly, 20AH rechargeable batteries, a vibration resistant CD player, a dual-channel wireless microphone system, a built-in amplifier and a speaker. AUX input and output connectors are provided to be used with any other PA or audio system. Provides 120W maximum power output. AC/DC operation, 2-5 hours usage per charge. Includes a handheld microphone, a belt-pack wireless transmitter, a headset microphone, a lavalier microphone and dust cover.

- 53045 13.8"W x 16.9"D x 25.6"H; weighs 65 lbs..... \$699.99 ea.



Hamilton Buhl® VENU80A Portable PA System

Featuring a powerful, high quality amplifier and lithium rechargeable battery.

This compact, lightweight, yet powerful PA system includes SD and USB inputs and high-quality wireless microphones. Also includes canvas carrying bag. Dimensions: 11.2" x 7" x 6.2". Weight: 4.5 lbs.

Features:

- Power Output: 40W • Frequency: 60Hz-15KHz ±3dB • Loudspeaker: 4.5" Full Range Sound • Input: Wireless/Wired Mic In, Line In • Media Inputs: USB 16GB, SD 8GB • (1) Handheld Wireless Microphone • (1) Remote Control • (1) AC Adapter • (1) Shoulder Strap • (2) AA Batteries (for Microphone)

- 54342 VENU80A with Canvas Travel Bag \$369.99 set
 54344 Replacement Wireless Mic., Frequency 915 MHz 89.99 ea.



GPX® Karaoke Machine
 Stream songs using Bluetooth Technology!

Supports profile A2DP & device reconnect. Features: CD/CD-R/RW, CD+G, LED light effects, track/s repeat, programmable tracks, pairing button, aux/3.5mm input, composite video & RCA stereo audio outputs. Wireless range: 60ft. Includes microphone & AC/DC power adapter. 10.53"L x 9.36"W x 15.99"H. 6.53 lbs.

- 54332 \$129.99 ea.



iLive® Wireless Event Speaker
 Ideal for classrooms, parties, tailgating and more!

Bluetooth technology and a built-in 12V battery make this an ideal portable speaker for presentations. Features: FM radio, retractable handle, and roller wheels. 14.575"L x 8.9"W x 18.6"H. Weighs 11 lbs.

- 16841 \$153.99 ea.

AUDIO

iLive® Bluetooth Tower Speaker w/ Remote

Use your smartphone to bring the music to your class!

Features bluetooth wireless up to 60', supports profile A2DP, 2-channel stereo sound, built-in stereo speakers, aux in (3.5mm audio input), RCA stereo audio inputs, digital volume control, AC power input.

Includes: remote control (requires a CR2025 battery (preinstalled), RCA stereo audio cable, AC/DC power adapter, warranty, user's guide.

54330 \$67.99 ea.



iLive® Wireless Speaker

Wirelessly stream music via Bluetooth!

Built-in handle and rechargeable battery. Dual 4" full range speakers with Micro-USB port for recharge. LED function indicator, bass, treble and volume controls and 3.5mm Aux in. Measures 18.35" x 7.48" x 9.45" and weighs 4.34 lbs.

53048 \$51.99 ea.



iLive® Alexa™ Enabled Wireless Fabric Speaker

Use Alexa to play music, set timers, ask questions and more!

Use voice commands to bring fun into the class and get everyone involved. Features Wi-Fi, multi-room play, 3.5mm aux input, micro USB port, play and pause & pairing button, digital volume control and LED light ring. Wireless range is 33 ft. and Bluetooth range is 98 ft. Rechargeable Li-Ion battery gives you up to 5 hours of playtime. Includes iLive app, 3.5mm audio cable, micro USB to USB cable, user's guide. Measures 8.06"W x 3.94"D x 3.94"H.

54331 \$99.99 ea.



Bose® SoundTouch® 30 Series III Wireless Music System
Connects directly to wi-fi networks!

It uses exclusive waveguide technology engineered around a high-performance woofer to produce deep, rich sound. Displays in-depth song, artist, station and connectivity information on an OLED screen. Includes auxiliary and USB inputs, USB and Ethernet port and 6 preset buttons. Measures 9.7" H x 17.1" W x 7.1" D. Weighs 25 lbs. Includes power cable, USB cable, and remote control.

X53944 \$999.99 ea.



Bose® SoundTouch® 10 Wireless Music System
Access your favorite music instantly!

Stream music through music services like Spotify, Pandora, iHeartRadio and more. Includes auxiliary and USB inputs and 6 preset buttons. Measures 8.34" H x 5.56" W x 3.43" D and weighs 2.89 lbs. Includes power cable, USB cable and remote control.

53596 \$289.99 ea.



iLive® Bluetooth System
Supports Bluetooth v2.1.

Features 2.1 channel stereo sound, subwoofer for enhanced sound, bass and treble controls, Ambient blue LED light effects and a wireless range of 33 feet. The subwoofer produces deep bass and works together with the stereo speakers to produce dynamic sound. Includes a built in amplifier and a 3.5mm to RCA audio cable. Measures 12L" x 10.7W" x 8.8"H; weighs 7 lbs.

53047 \$61.99 ea.



iLive® Bluetooth Music System

Built in Bluetooth technology for streaming music. Connect your smartphone, play CD's or tune to FM radio! USB port for charging devices. Turn on the color-changing lights with auto and manual color-changing modes. Features: digital clock, sleep timer, AC power cable, and full function remote (battery included). Wireless range: 33ft.

54274 \$134.99 ea.



GPX® CD Boombox

Plays CDs, CD-R/RW discs!
Top loading CD features AM/FM radio, Programmable tracks, Telescopic FM antenna, built in speakers, LED display and 3.5mm audio input. AC/DC powered and Battery powered requires 6 C batteries (not included).

53557 \$45.99 ea.



iLive® Boombox

Streams music from your Bluetooth™ enabled device! Includes a line input for additional playing options. Features CD/CD-R/RW, FM radio and a wireless range of 33 feet. AC/DC power or uses 6 C batteries (not included). Measures 13.23"L x 5.8"W x 9.7"H. Weighs 4.2 lbs.

53568 \$51.99 ea.

AUDIO



Amplivox Fitness Package with Transmitter
Ideal for any fitness class!

Includes a waterproof microphone headset, a wireless 16 channel UHF bodypack transmitter and wireless transmitter fitness belt. The neoprene belt pack secures around the wireless transmitter in a pouch around the waist. Headset has rugged cable and connector with flexible gooseneck design.

54280 \$279.99 pk.

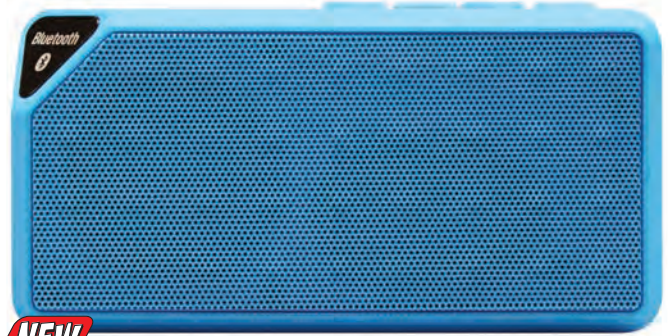

NEW

Hamilton Buhl® Bluetooth Cordless Cube Speaker
Get quality sound from this small yet powerful amplifier.

Compatible with Bluetooth-enabled devices or via the 3.5 mm audio input. The Bluetooth range is 32' - 49'. Rechargeable battery runs up to 6 hrs. and charges via micro USB charger (included). Measures: 4"W x 2"H x 1.25"D.

54341 \$39.99 ea.



Waist Band PA Amplifier

Easy to use portable sound system!

Comes with a with a headset microphone and carry bag. 7 Watt power from 8 AA batteries. Belt is 44" long. Batteries are not included.

53037 \$39.99 ea.

Wireless Half Mile Hailer

The solution to be heard above a loud and noisy crowd!

Powerful 50W multimedia stereo amplifier with 3 mic inputs. Weatherproof reverberant horn speaker. Emergency siren button. Power up to 200 hours with 10 D batteries (not included). Includes shoulder strap. Unit measures 11"H x 12"W x 10"D. Wireless Half-Mile Hailer Kit includes Half-Mile Hailer, a horn speaker, 40' cable, 2 compact tripods, nylon carry case and a wireless lapel mic and headset mic with body pack transmitter.



54260 Half Mile Hailer w/wired mic \$412.99 ea.

54261 Wireless Half Mile Hailer w/lapel & headset mic 618.99 ea.

54262 Wireless Half Mile Hailer w/handheld mic 662.99 ea.

54263 Wireless Half Mile Hailer Kit 1,017.99 kit



Motorola CLS 2 Way Radios

Improve response time & staff communication!

Coverage with 1 Watt of power provides a range up to 5 flat miles, up to 150,000 sq. ft. in buildings or up to 15 floors- sure to cover most Elementary and Jr. High Schools. Includes 56 business UHF frequencies, 121 interference eliminator codes to prevent hearing others or being heard. Also includes VibraCall® and LCD display with battery meter and signal strength indicator. Includes rechargeable battery- up to 12 hours of use, individual charger and plastic swivel holster. Available in 1 or 4 channel. CLS1410 6 Pack includes 6 of the CLS1410 Two Way Radios and a 6 unit charger.

53131 CLS1110 1 Channel Two Way Radio \$159.00 ea.

53132 CLS1410 4 Channel Two Way Radio 179.00 ea.

53136 4 Channel 6 Radio Pack- 6 CLS1410 radios & charger 1,215.00 pk.



Motorola Talkabout T200

Ideal for outdoor use.

Range: 1 mile urban areas, 5 miles over water and 20 miles outdoors line of sight. Includes 2 radios, 2 rechargeable batteries and charging adaptor.

53140 \$69.99 pr.



Replacement Batteries

Top quality at a low price!

Alkaline batteries for industrial use. Available in AAA, AA, C and D sizes.

53100 AAA \$0.99 ea.

53101 AA 0.99 ea.

53102 C 1.79 ea.

53103 D 1.99 ea.

TIMERS



3 YEAR GUARANTEE



LED Race Clock

Includes tripod, wireless remote and carrying case.

- Counts up/down to 99:59:59
- Start/stop with time out capability
- Choice of 1 second or 1/100 second resolution
- Bright LED digits – First (4) 8.25" tall, last (2) 5.5" tall
- AC adapter & rechargeable battery included
- Indoor/outdoor, battery life up to 5 hrs.

48147 35.5"W x 11.75"H \$1,839.99 set



Count Up/Down Clock

Includes 8 hour rechargeable battery.

- Counts up/down to 99:59
- Bright LED 4" digits, 12/24 hr. clock
- Built-in control panel with horn
- 120v AC power

BEST BUY

48127 13"L x 6"H x 4"W \$229.99 SALE \$199.97 ea.



Vulcan Limitless Timer

Versatile timer with programmable count up/down options.

- Interval timing w/ work and rest times & stopwatch function
- Large 4" digits and loud timer alarm
- Includes AC adapter w/ 15' cord, wall mount brackets and remote
- Remote requires 2 AAA batteries (not included)

48185 28.5"L x 6.25"H x 1.625"D \$259.00 ea.

Robic® Display Timer

Features a loud alarm & push button operation.

- Counts up/down from 1 sec. to 100 minutes
- 3 preset times – 12, 30 and 45 minutes
- Bright 6" LED digits
- Pause and time out timing
- AC adapter & remote control included
- Hang on the wall or use on a table

48160 17"L x 9"W x 2"D \$349.99 ea

MegaTimer

Lightweight and portable.

- Time, date, countdown timer, stopwatch, alarm and temperature
- Student/Team selector button generates random number
- Random mode operates as a dice, spinner or generates math problems
- Requires 6 AA batteries (not included)

48182 9.5"L x 6.5"H \$54.99 ea.



MORE INFO ONLINE @

www.palossports.com



Ultrak® L10 - Multi-Lane Timer

Choose between wired or wireless lane buttons.

- Times races up to 10 lanes
- Times cross country meets w/ up to 8k participants
- Provided linkgate connects ten lane buttons to a separate unit
- 4 digit bib number entry at finish or add/edit after event
- Data can be uploaded to a PC or printed out.
- Compatible w/ Hy-Tek, RunScore, Easy Meet Manager & more.

48015 Timer w/ 10 wired lane buttons \$729.99 SALE \$687.97 ea.

48096 Timer w/ 10 wireless lane buttons & 1 receiver 1,039.99 SALE 987.97 ea.

48016 Vinyl Carrying Case 37.99 ea.

48018 Box of 3 rolls of printer paper 19.99 ea.

VIDEO ONLINE

Jumbo Digit Single Timer

Easy to read 1.25" display digits.

Features include: alarm and memory, countdown function, easy on/off switch. Requires 1 AAA battery (included).

48027 \$21.99 ea.



Tally Counter

Counts up to 9999 with the touch of a button.

Resets to zero. Ideal for tracking attendance. Chromium plated.

48022 \$4.99 ea.

Air Horn

Good for up to 1000 blasts.

Ideal for athletics or any other outdoor area requiring a loud, clear signal. Half mile range. O-zone safe, nonflammable. Set includes one 8 oz. can of air and one horn.

47011 \$15.99 ea.

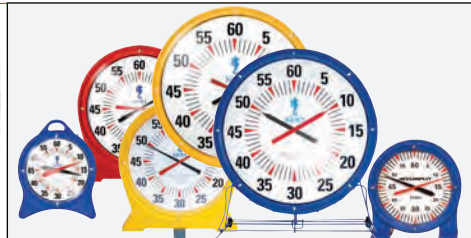

SEE OUR FULL LINE OF KIEFER® AND ACCUSPLIT® PACE CLOCKS

@ palossports.com

PORTABLE SCOREBOARDS



Portable Flip-A-Score
Built in handles to take anywhere!

This table top model scores up to 99 with large 6" numbers and period indicator. Folds flat for storage. Measures 24"L x 12"H.
49013 \$49.99 **SALE \$39.97 ea.**



Standard Flip-A-Score

A convenient, portable scorer for most competitive sports. Scores up to 99 for each team, with 4" white numbers on bright red and royal vinyl flippers. Numbers flip easily and lay flat with binder rings. Supported by a strong, triangular collapsible plastic frame. 20"L x 12"H.
49016 \$31.99 **SALE \$28.97 ea.**



Tachikara® Porta-Score

Lightweight and folds together for compact storage. Convenient, portable scoreboard keeps score to 99 and up to 9 on the middle counter. Handle provides easy transport. 7"H x 17"W.
49085 \$28.99 ea.



All Sports Flip-A-Score

Ideal for wrestling, football and basketball. This all purpose scoreboard features rugged, white plastic cards with large 5.5" numbers to score from 0-99. One set of numbers are printed in red, the other set is green. Center panel cards (printed in black) indicate period (1 to 4), or possession arrows. Attaches to a table with suction cups and folds for easy portability and storage. Measures 21"L x 17"H.
49011 \$78.99 ea.



Adjustable Scorekeeper

Freestanding or tabletop- how convenient! This scoring device is guaranteed to suit your needs as a 16"H table top unit or a 38"H freestanding floor model. Made from durable PVC tubing with 7"H numbers imprinted on vinyl and scores up to 99.
49030 \$64.99 **SALE \$49.97 ea.**



Deluxe Flip-A-Score

Contrasting colors for better visibility! This portable unit will keep track of the score and period or game number. Made from durable plastic, folds flat for storage and includes carry handle. Number panels are 9.6" long. Unit measures 23.6"L x 11.8"H.
49071 \$49.99 ea.

PORTABLE SCOREBOARDS



Tabletop Multi-Sport Indoor Scoreboard

Feature packed, convenient, and portable.

- Clock counts up/down from 99:99
- Scores to 199, period bonus
- Digital clock, horn/buzzer alarm
- Control panel, Possession indicator
- 5" LED clock/score digits visible to 150'
- Scoring/timing correction feature

X49041 24"L x 16"H x 10"D..... \$429.99 ea..

Multi-Sport Scoreboard Case

Fits Tabletop Multi-Sport Indoor Scoreboard

Heavy duty padded nylon with removable shoulder strap and zippered pouch. Dimensions: 16"H x 24"W x 10"D.

49043..... \$74.99 ea.



Indoor/Outdoor Tabletop Scoreboard

- LED readout is visible to 150 feet.
- Scores to 199, 4.75" clock & 4.25" score digits
 - Metronome, stopwatch, clock, alarm & timer
 - Control panel, possession indicator
 - Horn/buzzer, period bonus, fouls
 - Wireless remote (100' range)
 - Dual LED indoor/outdoor brightness
 - Scoring/timing correction
 - AC/DC with built in rechargeable battery
 - Up to 6 hr. battery life

49069 24"L x 16"H x 10"D, 24lbs..... \$499.99 SALE \$459.97 ea.

49070 Wheeled Stand - 43"H x 28"W x 28"D..... 99.99 ea.



Multi-Sport Portable Scoreboard

Indoor electronic tabletop scoring.

- Scores most indoor sports
- Clock counts up/down from 99:59
- 1/10th second timing in last minute
- Scores to 199, 4" LED display
- Workout, practice, circuit modes
- Control panel, possession indicator
- Horn, lights & period indicator
- Battery charger (battery not included)

X49014 22"L x 15"H x 8"D..... \$399.99 ea.

49017 Battery Power Pack..... 139.99 ea.



Ultimate Multi-Sport Scoreboard

Choose from seven colors.

- Bright LED digits - 12" score/clock, 8" period
- Scores to 99, 1/10th second timing in last minute
- Possession arrows & bonus lights
- Wireless controller w/ built in horn
- Measures 6'L x 3'W; weighs 100lbs.
- 5 year limited warranty

X48128 Scoreboard - Black..... \$2,399.99 SALE \$2,299.97 ea.

X48158 Scoreboard - Specify color..... 2,299.99 SALE 2,299.97 ea.

3 YEAR GUARANTEE

NEW



Ultrak SG-10 Segment & Multi-Purpose Timer

Operate the unit from its available smartphone app.

- LED digits viewable up to 300 ft.
- Left 2 digits - 7.5", right 2 digits - 12.5"
- Left - number of segments, right - segment time
- Program up to 99 segments between 1s - 99m, 59s
- Final minute counts down in seconds
- Operate with Free Smartphone app via Bluetooth or wireless remote (65ft. range)
- Store & download multiple programs in the app
- Volume control buzzer, AC adapter, 6 hr. battery
- Counts up/down to 99:59
- Scores to 99, clock mode included

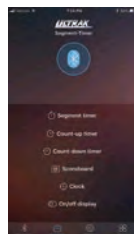

49089 25"L x 16"H x 2"D..... \$1,329.99 ea.



8' x 4' Wall Mount Scoreboard

Choose from seven colors.

- Super bright 15" LED digits visible up to 750ft.
- Clock counts down from 99:59, scores to 199
- 1/10th second timing in last minute
- Horn, 150' of control cable
- Galvanized steel cabinet w/ powder coat finish
- Measures 8' x 4'; weighs 160 lbs.
- 5 year limited warranty; ships by truck

T48156 Scoreboard - Specify color..... \$3,699.99 SALE \$3,499.97 ea.

48157 Optional Wireless Remote Control..... 1,599.99 SALE 1,499.97 ea.





OFFSET STAR MEDAL

Item	Size	1-9	10-199	200-999	1000+
M552241	2.75"	\$2.75 ea.	\$2.40 ea.	\$2.15 ea.	\$1.90 ea.

AS LOW AS \$1.90 1000+

MORE MEDALS ON OUR WEBSITE

MEDAL ENGRAVING
MAXIMUM 40 LETTERS
 WITHOUT INDIVIDUAL NAMES
 ADD 50¢ PER AWARD
 WITH INDIVIDUAL NAMES
 ADD 75¢ PER AWARD



WREATH MEDAL

Item	Size	1-9	10-199	200-999	1000+
M552231	2.5"	\$2.95 ea.	\$2.50 ea.	\$2.25 ea.	\$2.00 ea.

AS LOW AS \$2.00 1000+



WREATH RIBBON MEDAL

Item	Size	1-9	10-199	200-999	1000+
M552221	2.5"	\$3.75 ea.	\$3.25 ea.	\$2.95 ea.	\$2.50 ea.

AS LOW AS \$2.50 1000+

STOCK MYLARS

Baseball 4558	Baseball 4620	Baseball 4560	Baseball 4663	Basketball 4561	Basketball 4621	Basketball 4563	Basketball 4664	Bowling 4564	Bowling 4665
Dance 4615	Dance 4669	Derby 4572	Football 4573	Football 4631	Football 4616	Football 4670	Golf 4575	Golf 4671	Graduation 4576
Lacrosse 4617	Lacrosse 4674	Music 4584	Music 4632	Science 4586	Softball 4587	Softball 4633	Softball 4675	Soccer 4589	Soccer 4634
Track 4628	Track 4679	Volleyball 4601	Volleyball 4629	Volleyball 4680	Victory 4604	Victory 4681	Water Polo 4682	Wrestling 4605	All Star 4606



AS LOW AS \$2.00

SWIRLING STAR MEDAL

Item	Size	1-9	10-199	200-999	1000+
M551806	2.75"	\$2.95 ea.	\$2.50 ea.	\$2.25 ea.	\$2.00 ea.

FREE RIBBON WITH EVERY MEDAL!



AS LOW AS \$2.00

LAZER BRIGHT MEDAL

Item	Size	1-9	10-199	200-999	1000+
M551490	2.75"	\$2.95 ea.	\$2.50 ea.	\$2.25 ea.	\$2.00 ea.



AS LOW AS \$1.90

OPEN WREATH MEDAL

Item	Size	1-9	10-199	200-999	1000+
M551807	2.75"	\$2.95 ea.	\$2.40 ea.	\$2.15 ea.	\$1.90 ea.

MORE MEDALS ON OUR WEBSITE!

FREE CUSTOM INSERTS

ONLY TWO EASY STEPS!

1 Send us your logo or idea 2 Approve the final design

*Free with the purchase of 30 or more awards. Use promotion code 61140. Offer ends: 5/31/2019. Regular prices apply after promotion ends. See below.

Item	30-50	50-250	250+
	\$1.25 ea.	\$1.00 ea.	\$0.90 ea.



Logos shown are for display only and not for endorsement purposes.



- Boxing 4565
- Cheer 4566
- Cheer 4622
- Cheer 4666
- Chess 4568
- Cross Country 4569
- Cross Country 4667
- Coach 4570
- Dance 4571
- Dance 4630
- Female Gym. 4577
- Male Gym. 4578
- Hockey 4551
- Hockey 4623
- Hockey 4672
- Roller Hockey 4580
- Karate 4581
- Knowledge 4582
- Knowledge 4624
- Knowledge 4673
- Soccer 4591
- Soccer 4676
- Swimming 4592
- Swimming 4635
- Swimming 4677
- Tennis 4594
- Tennis 4678
- MVP 4595
- T-Ball 4502
- Track 4599
- 1st Place 4625
- 2nd Place 4626
- 3rd Place 4627
- Spelling Bee 4607
- Flag 4608
- Year "2019" 4686
- Praying 4610
- Cross 4611
- Ping Pong 4612
- Car Show 4613



M552307 Baseball - 2"
M552318 Baseball - 2.75"

AS LOW AS
\$1.30
1,000+

**GOLD
SILVER
BRONZE**

**MEDAL
ENGRAVING**
MAXIMUM 40 LETTERS
WITHOUT INDIVIDUAL NAMES
ADD 50¢ PER AWARD
WITH INDIVIDUAL NAMES
ADD 75¢ PER AWARD

2" STARBRITE MEDALS

Item	1-9	10-199	200-999	1000+
Specify Sport	\$2.50 ea.	\$2.10 ea.	\$1.60 ea.	\$1.30 ea.

**AVAILABLE
IN 2 SIZES**

2.75" STARBRITE MEDALS

Item	1-9	10-199	200-999	1000+
Specify Sport	\$2.95 ea.	\$2.50 ea.	\$2.35 ea.	\$2.00 ea.



M552308 Basketball - 2"
M552319 Basketball - 2.75"

M552309 Bowling - 2"
M552320 Bowling - 2.75"

M552310 Cross Country - 2"
M552321 Cross Country - 2.75"



M552311 Football - 2"
M552322 Football - 2.75"

M552312 Knowledge - 2"
M552323 Knowledge - 2.75"

M552330 Soccer - 2"
M552324 Soccer - 2.75"

M552313 Victory - 2"
M552325 Victory - 2.75"

M552314 Track - 2"
M552326 Track - 2.75"



M552315 Volleyball - 2"
M552327 Volleyball - 2.75"

M552316 Wrestling - 2"
M552328 Wrestling - 2.75"

M552317 1st, 2nd or 3rd - 2"
M552329 1st, 2nd or 3rd - 2.75"

FREE RIBBON WITH EVERY MEDAL • YOUR CHOICE OF COLOR OR SPORT





Satin Stock Ribbons

2" x 8" ribbons with two streamers and event card on back.

Item	Specify	1-50	51-499	500+
55050	1st Place - Blue	\$0.50 ea.	\$0.40 ea.	\$0.35 ea.
55051	2nd Place - Red	0.50 ea.	0.40 ea.	0.35 ea.
55052	3rd Place - White	0.50 ea.	0.40 ea.	0.35 ea.
55053	4th Place - Pink	0.50 ea.	0.40 ea.	0.35 ea.
55054	5th Place - Yellow	0.50 ea.	0.40 ea.	0.35 ea.
55055	6th Place - Green	0.50 ea.	0.40 ea.	0.35 ea.
55056	7th Place - Light Green	0.50 ea.	0.40 ea.	0.35 ea.
55057	8th Place - Tan	0.50 ea.	0.40 ea.	0.35 ea.
55059	9th Place - Brown	0.50 ea.	0.40 ea.	0.35 ea.
55080	10th Place - Light Gray	0.50 ea.	0.40 ea.	0.35 ea.
55058	Participation - Green	0.50 ea.	0.40 ea.	0.35 ea.
55060	Honorable Mention - Green	0.50 ea.	0.40 ea.	0.35 ea.



MORE ONLINE

Wreath Activity Plaques

Sharp looking affordable plaques!

With over 50 Activity Inserts to choose from you can't miss with this award winning plaque. Plaque colors are available in a black or cherry finish. Your choice of black or gold plate.

Item	Size	1-99	100+
559023	5" x 7"	\$6.95 ea.	\$6.25 ea.
559024	6" x 8"	8.95 ea.	7.95 ea.
559025	7" x 9"	9.95 ea.	8.95 ea.
559026	8" x 10"	11.95 ea.	10.95 ea.



Metallic Chenille Pins

Gold tone metal pins have a clutch back & long pin.

	1-99	100-499	500+
Specify Sport	\$0.99 ea.	\$0.89 ea.	\$0.79 ea.

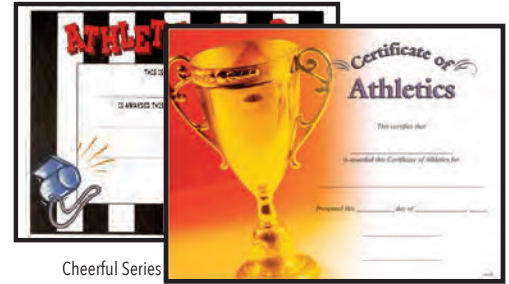

Cheerful Series

Dynamic Series

Award Certificates

Show your appreciation and recognition of great achievements in athletics by presenting them with a certificate. These striking full color 8 1/2" x 11" certificates are an inexpensive way to show your appreciation. Sold in packs of 30 only.

- 55020 Cheerful Series Athletic Certificate - Pack of 30 ... \$8.99 pack
- 55075 Dynamic Series Athletic Certificate - Pack of 30 ... \$8.99 pack



12" w/ Activity Insert 551161S

Style #1 Trophy

Choose from a variety of sizes, column colors, figures and more! Engraving is free up to 60 letters. Individual names add 50 cents per award.

STYLE 1	SIZE	1-5	6-99	100+
551181	10"	\$7.25 ea.	\$6.25 ea.	\$5.75 ea.
551171	11"	7.50 ea.	6.50 ea.	5.95 ea.
551161	12"	7.50 ea.	6.50 ea.	5.95 ea.
551161S	12"	7.95 ea.	6.95 ea.	6.45 ea.

PLAYGROUND



Gym-I-Nee®

Which numbered, colored chute will the ball exit? Increase accuracy, agility and catching skills by tossing any type of ball up into the basket. Molded from sturdy water proof plastic with a 3.5" diameter and 10' H steel pipe. Includes installation instructions and activity guide. Ships by Truck.

128193..... \$799.99 **SALE \$698.97 ea.**



Cut Proof Replacement Swing Seat

Molded rubber with steel plate insert, 6" wide. Available in 4 colors. Seat measures 24.5" long.

28022 Black..... \$26.97 **SALE \$26.97 ea.**
 28029 Blue..... 32.99 ea.
 28032 Red..... 32.99 ea.
 28033 Yellow..... 32.99 ea.



Infant & Toddler Seats

Start them swinging young! Cut proof belts make these seats a nice addition to a family park, preschool or community area. Seats only- chains not included.

28049 Infant Seat..... \$89.99 ea.
 28050 Toddler Seat..... 72.99 ea.



Elementary Recess Class Pack

53 pieces that will get your class playing!

Contents:

- 2 ea. 37501 Rubber Basketballs
- 2 ea. 10021 Playground Balls
- 1 set 10520 9" Fun Balls
- 2 ea. 33006 Rubber Volleyballs
- 1 set 43233 Throw Down Bases
- 1 set 12031 7' Jump Ropes
- 2 ea. 10805 Poof® Footballs
- 6 ea. 21008 12" Cones
- 1 set 12032 8' Jump Ropes
- 2 ea. 10032 Mikasa Kickballs
- 1 set 10530 12" Fun Balls
- 1 set 11025 Flying Discs
- 1 ea. 36114 Mesh Bag
- 2 ea. 24032 Ultra Bats
- 2 ea. 10806 Poof® Soccerballs
- 2 pr. 12013 16' Double Dutch Ropes

66210..... \$254.99 **SALE \$229.97 pk.**



Ultimate Recess Class Pack

The equipment you need and 251 games to play. Includes mesh color bags to store most of the equipment.

Contents:

- 2 sets 37116 Int. Rubber Basketballs
- 1 set 33105 Rubber Volleyballs
- 2 sets 50171 sz. 4 Rubber Soccer Balls
- 2 sets 32041 Int. Rubber Footballs
- 1 set 24033 Bat Set
- 2 sets 10530 12" Fun Ball Sets
- 2 sets 11025 9" Flying Discs
- 1 set 14017 36" Deluxe Hoop Set
- 6 sets 21026 9" Poly Spot Set
- 3 sets 10081 8" Playground Ball Sets
- 4 sets 21048 9" Cone Set
- 2 sets 12087 16' Speed Rope Set
- 1 ea. 36229 Red 36" x 45" Mesh Bag
- 1 ea. 36227 Orange 36" x 45" Mesh Bag
- 1 ea. 36226 Yellow 36" x 45" Mesh Bag
- 1 ea. 36225 Green 36" x 45" Mesh Bag
- 1 ea. 36230 Blue 36" x 45" Mesh Bag
- 1 ea. 36228 Purple 36" x 45" Mesh Bag

66232..... \$750.00 **SALE \$599.97 pk.**



PALOS Rubber Ball Class Pack

An ideal team sports recess kit.

Each set contains one set each of Palos Sports basketballs, footballs, soccer balls and volleyballs. Also includes 6 color coordinated 24" x 36" mesh bags. All balls made of durable rubber. Includes one of each ball in red, orange, yellow, green, blue and purple.

66215..... \$217.99 **SALE \$189.97 pk.**

PLAYGROUND



Tachikara® Tetherball
Premium nylon wound rubber ball. An excellent tetherball with a recessed metal hook. Includes 8' nylon rope. Gold only.
15161 \$16.99 **SALE \$14.97 ea.**
15205 Universal Tether Rope \$4.25 ea.



Tachikara® Super Soft Tetherball
Super soft play and feel. Constructed with a soft, sting free surface combined with a durable and weather resistant rubber. 8' nylon rope attached to recessed notch.
15155 Light Blue \$16.99 ea.
15157 Orange/Green 17.99 ea.



Mikasa® Soft Shell Tetherball
With a recessed rope attachment for smooth play!
A cushioned soft shell polyester cover is ideal for younger players. Great stitching with nylon rope.
15162 Gold \$16.99 ea.



Tachikara® Super Soft Fireball Tetherball
The fire graphics resemble an actual fireball while spinning. Constructed with a "Soft" diamond textured all weather rubber for a unique feel. 8' long nylon rope attached to durable recessed notch.
15944 \$19.99 ea.



Fun Gripper™ Tetherball
The ideal starter ball!
Soft and safe with a grippy textured cover, this is the ideal ball for young and new players. Includes 8' long nylon rope.
15972 \$24.99 ea.



Rhino® Soft-Eeze™ 9" Tetherball
Soft to the touch with great grip! Rhino® Skin cover and durable bladder. Great ball for younger players. Includes 8' nylon rope. Standard size 9".
15973 \$19.99 **SALE \$15.97 ea.**



Rhino® Soft-Eeze™ Oversized 10" Tetherball
Great ball for young players!
Ideal oversized beginner ball with easy grip Rhino® Skin cover and durable bladder. Includes 8' nylon rope.
15974 \$19.99 ea.



Mikasa Oversized Tetherball
Super soft and 20% larger!
Made of a cushioned textured synthetic cover. Butyl bladder for superior air retention. Braided nylon competition rope included. Measures 10" diameter.
17303 \$20.99 ea.

Outdoor Tetherball Pole
You supply the ball for hours of fun!
Heavy duty, two piece, galvanized 2 3/4" OD post for permanent in-ground installation. 12' long pole, buried 2' in ground for a 10' tall tetherball pole.
T15943 **SALE \$149.97 ea.**



Jaypro Portable Tetherball Pole & Ball
Play indoors or outside!
A sturdy 10' galvanized 2" O.D. steel upright has a 12" pre-assembled leader chain with a 24" diameter 75 lb. steel base with a rubber rim and non-marring wheels. Weighs 100 lbs. total. Includes Tachikara Tetherball.
T16839 \$429.99 pk.



The ZONE POWRBASE & Tetherball Post
Fully adjustable, can be used with universal tethers. Strong PVC base can be filled with water, sand or pea gravel and transports easily. Insert the steel post and use a single bolt to lock in place and prevent unwanted spinning. Tall post adjusts from 61"-95"H and has a push pin locking system.
30245 \$129.99 set.



TIP 'N' ROLL

Tip 'N' Roll Bleachers

Perfect for indoor/outdoor seating.

- Standard Footboard planks are 2" x 10" wide.
- Preferred Footboard planks are two 2" x 10" wide.
- Unit easily tips up on its high grade swivel casters
- Welded aluminum framework with cross braces
- Rubber foot pads will not mar your floor
- Seat and foot planks are 10" wide with non-skid grooves.
- Assembly required.
- 2 & 3 Row Bleachers first seat 16"H, 4 Row Bleachers first seat 12"H.
- Fast Ship- ships within 72 hours. Actual delivery time will vary depending on location.
- Call for freight quote- Our regular shipping policy does not apply to bleachers.



Description		Standard Benches			Preferred Benches		
Dimensions	Seats	2 Rows	Weight	Price	2 Rows	Weight	Price
9'L x 26"H x 36"D	12	T25601	128 lbs	\$647.99 ea.	T25632	145 lbs	\$731.99 ea.
15'L x 26"H x 36"D	20	T25530	199 lbs	992.99 ea.	T25633	226 lbs	1,107.99 ea.
21'L x 26"H x 36"D	28	T25531	245 lbs	1,316.99 ea.	T25634	282 lbs	1,462.99 ea.
Dimensions	Seats	3 Rows	Weight	Price	3 Rows	Weight	Price
9'L x 29"H x 60"D	18	T25602	173 lbs	867.99 ea.	T25635	206 lbs	1,013.99 ea.
15'L x 29"H x 60"D	30	T25532	271 lbs	1,400.99 ea.	T25636	325 lbs	1,608.99 ea.
21'L x 29"H x 60"D	42	T25533	343 lbs	1,880.99 ea.	T25637	419 lbs	2,194.99 ea.
Dimensions	Seats	4 Rows	Weight	Price	4 Rows	Weight	Price
7.6'L x 30"H x 84"D	20	T25603	240 lbs	1,253.99 ea.	T25638	282 lbs	1,253.99 ea.
15'L x 30"H x 84"D	40	T25604	371 lbs	1,985.99 ea.	T25639	452 lbs	1,985.99 ea.



SINGLE FOOTBOARD STANDARD



DOUBLE FOOTBOARD PREFERRED



Stationary Aluminum Bleachers

Heavy duty outdoor seating.

- Frame work is welded aluminum angle.
- Seat planks are 2" x 10" wide anodized aluminum
- Standard Footboard planks are 2" x 10" wide.
- Preferred Footboard planks are (two) 2" x 10" wide
- 3 Row Bleachers first seat 16"H, 4 Row Bleachers first seat 12"H
- Some assembly required.
- Fast Ship-ships within 72 hours. Delivery time will vary depending on location.



All bleachers should be anchored to resist wind. Please contact your local code authority for compliance with your applicable codes.

Description		Standard Benches			Preferred Benches		
Dimensions	Seats	3 Rows	Weight	Price	3 Rows	Weight	Price
15'L x 28"H x 57"D	30	T25542	236 lbs	\$1,211.99 ea.	T25573	290 lbs	\$1,483.99 ea.
21'L x 28"H x 59"D	42	T25543	333 lbs	1,682.99 ea.	T25574	409 lbs	2,058.99 ea.
27'L x 28"H x 57"D	54	T25568	415 lbs	2,152.00 ea.	T25575	515 lbs	2,664.99 ea.
Dimensions	Seats	4 Rows	Weight	Price	4 Rows	Weight	Price
15'L x 29"H x 7'D	40	T25534	407 lbs	\$1,817.99 ea.	T25576	489 lbs	\$2,173.99 ea.
21'L x 29"H x 7'D	56	T25535	528 lbs	2,465.99 ea.	T25577	652 lbs	2,925.99 ea.
24'L x 29"H x 7'D	64	T25699	621 lbs	2,967.99 ea.	T25700	751 lbs	3,500.99 ea.



SINGLE FOOTBOARD STANDARD



DOUBLE FOOTBOARD PREFERRED

BENCHES



Insta-Bench™

Pop up 6 player seating wherever you need it!

Designed for heavy duty use, these benches are made from 600 Denier polyester with steel frames, oversized rivets, molded grommets and well balanced feet. Six seat frames withstand 250 lbs. per seat. Includes 600 Denier polyester carry bag with reinforced seams to prevent splitting. Collapses for easy transport and storage. Measures 104"L x 19"W x 17"H; weighs 20 lbs. Available in 4 colors.

X28126 Black	\$129.99 ea.
X28127 Red	129.99 ea.
X28128 Royal	129.99 ea.
X28129 Forest Green.....	129.99 ea.



TravelChair® 5 Player Bench

Wider seat per player for more room, seat back for better rest!

No assembly required- just pull it out from the carry bag, unfold and you're all set. Made with a double layer of 600D polyester with a powder coated steel frame to resist rust. Improved zippered carry bag. Each bench has a removable banner on back for custom screen printing. Call for printing details. Measures 100"L x 19"W x 17"H (seat height); weighs 27 lbs. Available in black only.

X28123	\$149.99 ea.
--------------	--------------



IMPORTANT

Important information about Aluminum Bleachers and Benches.

We offer extended quantity discounts and other bleachers and benches not shown in our catalog. Prices are subject to change.

CALL FOR FREIGHT QUOTE
1-800-233-5484

Our regular shipping policy does not apply.

Heavy Duty Portable Aluminum Bench

Indoor bench with rubber pads.

- All seats and backs come with 10" anodized aluminum planks with end caps.
- Frames constructed with reinforced aluminum for superior support
- Available in 8', 15' or 21' lengths
- Improved back supports, Assembly required

C25710 8'- 66 lbs.	\$388.99 ea.
C25711 15'- 92 lbs.	686.99 ea.
C25712 21'- 141 lbs.	916.99 ea.



All Weather Bench

Seating for all occasions.

These fiberglass stackable seat benches can be used anywhere temporary seating is needed. The durable all-fiberglass construction is safe for indoor and outdoor use while the lightweight and stackable design provides convenient handling and storage. Weighs approximately 30 lbs. Measures: 18"D x 18"H x 72"L. Maximum weight capacity of 500 lbs. Available in Gray, Kelly Green, Navy, Bright Red, Royal Blue, White, or Bright Yellow. Specify Color.

T58177	\$649.99 ea.
--------------	--------------

TEAM CHAIRS



MINIMUM ORDER 6

PLEASE CALL FOR FREIGHT QUOTE

SideLine Folding Chairs

Price includes 2 color logo in 2 locations!

- Custom frame and vinyl colors!
- 2.5" foam padded seat cushion
- 14"W x 15"H imprint area on cushion
- 1" foam padded seat back
- 13"W x 5"H imprint area on seat back
- 10"W x 2"H imprint area on chair front
- Heavy 30 oz. vinyl on seat back and cushion

- Custom design assistance
- Strong 16 gauge steel frame
- Chair legs have rubber caps to protect floors

Delivery typically takes 4-6 weeks. Please specify frame and vinyl color and imprint. 6 chair minimum. Call for freight quote- our normal shipping policy does not apply.

C49077 SideLine Folding Chair-6 Chair Minimum **\$102.99 ea.**
C49078 12 Chair Pack **1,213.99 pk.**

SEAT/BACK COLORS

Black	White	Red	Maroon	Orange	Purple	Royal	Navy	Forest
-------	-------	-----	--------	--------	--------	-------	------	--------

Universal Folding Chair

Excellent chair to fit your budget!

- Custom frame and vinyl colors
- 2 color design in 2 locations
- 10"W x 8"H or 8"W x 10"H seat imprint area
- 14"W x 5"H backrest imprint area
- Free stock designs to choose
- Custom design assistance
- Heavy duty vinyl seat

MINIMUM ORDER 24

PLEASE CALL FOR FREIGHT QUOTE

- Curved backrest for lumbar support
- Strong steel frame
- Frames have powder coat finish
- Non-marring leg caps
- Max. wt. capacity 300 lbs.
- Measures 20"L x 17.5"W x 32"H
- Folds to 4.5"L x 17.5"W x 40"H

Folding Chair with 2 Color Imprint in 2 Locations: typically takes 8-12 weeks, specify frame & vinyl color & imprint. 24 chair minimum. Call for freight quote- our normal shipping policy does not apply.

C49068 24 Chair Minimum **\$94.99 ea.**

SEAT/BACK/FRAME COLORS

Black	White	Red	Maroon	Orange	Gold	Kelly	Forest	Royal	Navy	Purple	Silver
-------	-------	-----	--------	--------	------	-------	--------	-------	------	--------	--------

Custom Court Chairs

Create your design in your colors!

Heavy duty steel frame with 1" padded seat cushion and backrest. Seat and back covered with thick 26 oz. vinyl. Minimum order is 24 chairs with your choice of frame, seat & seat back color and custom imprint on seat or seat back. Call for freight quote- our normal shipping policy does not apply.



MINIMUM ORDER 24

PLEASE CALL FOR FREIGHT QUOTE

C49004 Custom Color with 1 color print, 1 location -24 Chair Minimum **\$90.99 ea.**

SEAT/BACK COLORS

White	Tan	Orange	Red	Burgdy	Sky	Royal	Navy	Black	Grey	Purple
-------	-----	--------	-----	--------	-----	-------	------	-------	------	--------

FRAME COLORS

Red	Black	Grey	Navy	Purple	Royal Blue
-----	-------	------	------	--------	------------



MORE COLORS AVAILABLE PLEASE CALL CUSTOMER SERVICE

MINIMUM ORDER W/ NO IMPRINT 6

MINIMUM ORDER W/ IMPRINT 24

Locker Room Stool

Impressive looking and stores inside most lockers!

- Custom frame and vinyl colors
- 6" diameter imprint area
- Free stock designs to choose
- Custom design assistance
- Heavy duty vinyl seat
- Strong steel frame

- Non-marring leg caps
- Max. wt. capacity 300 lbs.
- Measures 13"L x 15"W x 25"H
- Folds to 3.5"L x 15"W x 29"H
- Plain Locker Room Stool available

Typically takes 2 weeks, specify frame & vinyl color. 6 chair minimum.

Call for freight quote- our normal shipping policy does not apply.

C49055 Plain Locker Stool- specify color-6 Chair Minimum **\$41.99 ea.**

Locker Room Stool with 2 Color Imprint 1 Location

Typically takes 8-10 weeks, specify frame & vinyl color & imprint. 24 stool minimum.

C49057 24 Chair Minimum **\$46.99 ea.**

FRAME COLORS

Black	Maroon	Red	Orange	Kelly	Forest	Royal	Navy	Purple	Silver	White
-------	--------	-----	--------	-------	--------	-------	------	--------	--------	-------



2 IMPRINT AREAS!



Chair Cart

Safely store up to 36 chairs.

Constructed with a heavy duty steel frame and 4" caster wheels. Measures 80"H x 64"L x 34"W. Weighs 127 lbs. Some assembly required. Cart cover includes 3 color logo, specify vinyl color. Call for freight quote- our normal shipping policy does not apply to this item.

PLEASE CALL FOR FREIGHT QUOTE

C49079 Chair Cart **\$386.99 ea.**

49080 Cart Cover- Specify color & logo **173.99 ea.**

**MORE MODELS & DETAILED DESCRIPTIONS
ONLINE @ PALOSSPORTS.COM**



Kidsfit® Pedal Desk

Great for teachers that want focused and engaged students.

The Pedal Desk brings active learning into the classroom. High energy or fidgety students work out energy while maintaining their focus on the teacher. A variety of styles available. Adjustable height. Comes complete with scratch-resistant rubber feet and wheels for portability. Weight Limit: 250lbs. Height: Single from 36" - 48"H, multi from 35" - 45"H.

- T59130 Small (K - 2nd), Single, 28"L x 40"W x 36"-48"H \$995.00 ea.
- T59131 Elementary (3rd - 5th), Single, 28"L x 40"W x 36"-48"H 995.00 ea.
- T59132 Elementary, 2 Person, 28"L x 54"W x 35"-45"H 1,990.00 ea.
- T59133 Elementary, 4 Person, 56"L x 108"W x 35"-45"H 3,320.00 ea.
- T59134 w/ Resistance (6th & up), Single, 28"L x 40"W x 36"-48"H 1,211.00 ea.
- T59135 w/ Resistance (6th & up), 2 Person, 28"L x 54"W x 35"-45"H 2,180.00 ea.
- T59136 w/ Resistance (6th & up), 4 Person, 56"L x 108"W x 35"-45"H 3,320.00 ea.



Kidsfit® Strider Standing Desk

Incorporates noise-free movements to engage students within the classroom. Gliding motion allows students to smoothly accelerate forward using the lower body while simultaneously completing tasks on the ample work space desk. Second grade & up. Weight Limit: 250 lbs. Dimensions: 36"L x 28"W x 44-48"H. Weight 70 lbs.

- T59145 Single, 36"L x 28"W x 44-48"H \$1,040.00 ea.
- T16452 2 Person, 72"L x 28"W x 44-48"H 2,085.00 ea.



Kidsfit® Ergospin Desk

- T59138 Single 39"L x 29"W x 25"-32"H \$1,040.00 ea.
- T59139 2 Person 54"L x 29"W x 35"-45"H 1,610.00 ea.



Kidsfit® Kneel-N-Spin Desk

- T59140 Single 24"L x 28"W x 28"-36"H \$1,135.00 ea.
- T59141 2 Person 54"L x 30"W x 35"-45"H 1,420.00 ea.
- T59142 4 Person 54"L x 30"W x 35"-45"H 2,275.00 ea.



Kidsfit® Foot Fidget Standing Desk

- T59143 Single, 30.5"L x 40.5"W x 40"H \$945.00 ea.
- T59144 2 Person, 22"L x 60"L x 33"-38"H 1,420.00 ea.

NUTRITION

Skeleton Floor Puzzle

Attach the head bone to the neck bone, and much more!

Encourages kids to explore the human body by piecing together a life-size puzzle. Features 15 illustrated pieces with both formal and common bone names printed on the reverse side.

Soft foam puzzle measures 4'H when assembled.

21203 \$29.99 ea.



NEW



Fruits and Veggies Spot Markers

Learn about healthy eating while getting active.

Reinforce healthy eating habits during gym classes or recreational activities. Create fun circuit games or use to designate teams. Durable 9" markers are skid resistant and lay flat. Made of foam rubber with a neoprene cover. Set of 12.

74596 \$18.20 set



NEW

Fruit & Veggie Bean Bags

Double sided bean bags teach kids about nutrition while staying active.

Reinforce healthy eating habits during gym classes or recreational activities. One side pictures a healthy fruit or vegetable, while the other displays the printed name. Made with a soft neoprene cover and filled with plastic pellets. Measures: 4.5"D x .75" thick. Set of 12.

26092 \$35.99 set



Garden Heroes™ Bean Bags

Plush fruit and vegetable characters will be a hit in your classes!

Designed with P.E. in mind! Weighted for great tossing and embroidered so no parts come loose! Durable seams, machine washable. Measures 3" to 7" tall. The Fruit & Veggie Fun Book includes creative and challenging elementary games and activities for physical education. Book provides equipment lists, set up diagrams, instructions and more. Kit includes Fun Book, 12 Fruit & 12 Veggie Garden Heroes.

50310 Fruit & Veggie Fun Book & 24 Garden Heroes \$99.99 kit

50311 Fruit Garden Heroes Set of 12 49.99 set

50312 Veggie Garden Heroes Set of 12 49.99 set

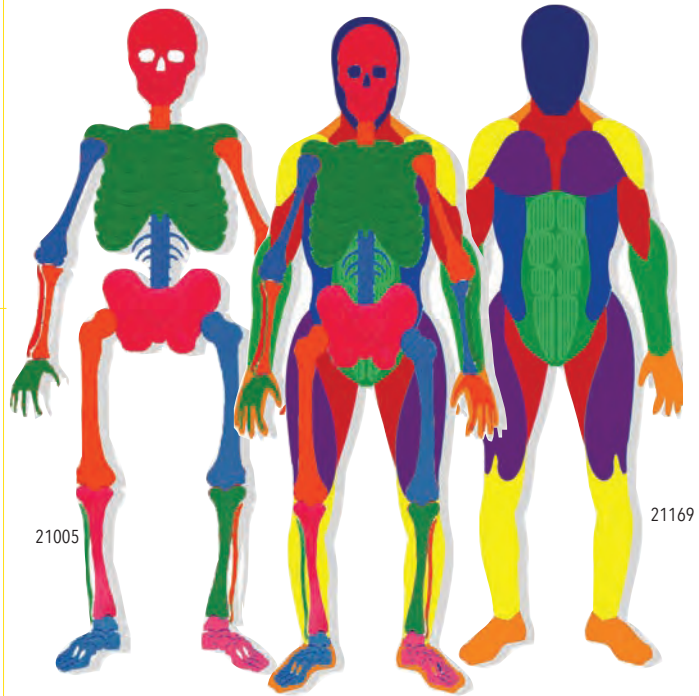

21005

21169

21170

Poly Body Puzzles

Identify organs, muscles and bones!

The Muscle Man shows all major muscles and the Poly Bones shows the major bones. Assemble them individually, or together showing how they integrate. Poly vinyl puzzles will not fade, tear or crack for years. Both puzzles are about 7'L.

21005 Poly Bones - 21 pieces \$65.99 ea.

21169 Muscle Man - 25 pieces 66.99 ea.

21170 Both puzzles 129.99 set



FOR UP TO 60 PLAYERS!



Muscle Hustle™

A fast moving, muscle matching workout!



Divide class into 3 or 6 groups. Players must determine and find the muscle to be strengthened by the exercise on their Muscle Strip™. Once they find the correct muscle spot, they perform ten repetitions of the exercise.

Designed for elementary through junior high use, available in 3 or 6 color sets. Full color and laminated Muscle Cards™ measure 8.5" x 11" and Muscle Strips™ measure 8" x 2". Muscle Group HotSpots™ sold separately.

21154 3 Color Set- 3 Muscle Cards, 54 Muscle Strips and instructions \$44.99 set

21153 6 Color Set- 6 Muscle Cards, 108 Muscle Strips and instructions 84.99 set

21148 Muscle Group HotSpots™- Set of 12 14.79 set

NUTRITION



Skillastics® Nutritional Cards

The answer to integrating nutrition with physical activity!

Based on MyPlate™ and containing 15 thought provoking questions for each food group, empty calories and oils. Use alone or with any Skillastics® game.

Nutrition Card Set

Ideal for upper elementary, middle and high school.

Includes 630 cards featuring 105 questions for each of the 6 colors.

52206 \$64.99 set

Lower Elementary Card Set

For grades 1st-3rd.

Includes 360 cards featuring 60 questions for each of the 6 colors.

53861 69.99 set



MyPlate™ Cling Kit

Challenges you to make a proper plate!

Includes 5 MyPlate™ place mats and 98 food clings but beware, some foods do not belong on your plate! Ideal teaching tool for learning proper meal making. Includes reproducible sheet with nutrition information on each food item.

25136 \$66.99 kit



Fruits & Veggies Bingo

Appropriate for grades 6 and up!

The clues given are more academic and players really have to think! Clue cards depict a variety of foods and beverages using serving sizes, nutrient values, descriptions and more. For up to 30 players! Includes: 30 laminated 8.5" x 11" bingo cards, 72 clue cards, a master list and directions.

52958 \$48.99 SALE \$44.97 set

Physical Activity Bingo

Ideal for the gym or the classroom!

When each activity is called, the whole class performs it and players who have the activity on their card cover it. Includes 30 laminated 8.5" x 11" cards.

15189 \$64.99 set



NEW

ZONE Fast Food Foolery

Introduce proper nutrition concepts through active play.

Perfect for Health and Nutrition classes, or even as a quick "brain break." Randomly chosen students begin the game holding one of the 3 included fast food components (cheeseburger, fries, drink). The remaining students try to avoid being tagged by the unhealthy food. If tagged, they must take the food component and try to get rid of it by tagging another student. Game teaches proper eating habits and spatial awareness. Includes: soft drink, loose fries/container, cheeseburger with bun and toppings. Meets national standards 1 – 5. Two or more sets recommended for large class sizes. ⚠️ CHOKING HAZARD (1) - SMALL PARTS. Not for under 3 yrs.*

17370 \$19.99 set



VIDEO ONLINE *

Play Food Set

A great visual for learning facts about nutrition!

Includes over 75 pieces of realistic plastic molded food items. Use to clarify serving sizes, reinforce food pyramid theories and use for fun food games! Includes plastic storage case.

52419 \$149.99 set



5 Minute Fruit & Vegetable Activities

Features 50 quick and fun activities!

Get students thinking about what they eat! Pre-K through High School.

16052 \$31.99 ea.



Your Body Is Your Gym Poster Set

Get physically fit just using your body!

No special equipment needed. Features flexibility, balance, strength and cardio physical activities with instructions. Set of 4 laminated 18" x 24" posters.

38232 \$39.99 set

* Full CHOKING HAZARD descriptions on page 355.

BRAINball™ A PHYSICAL EDUCATION CROSS CURRICULAR SYSTEM

"Learning through play."



What is BRAINball™?

BRAINball™ is an innovative and unique physical education learning system that merges physical activity and academic learning through play.

Instructors and students use 100 mini soccer and basketballs and 100 lesson plans to develop math, reading, grammar, spelling, anatomy and foreign language skills. In addition to the physical benefits, significant improvement will be seen in gross and fine motor skills, cooperative and cognitive learning. BRAINball™ can be incorporated into Adapted Physical Education programs as well as those teaching students with learning disabilities, such as dyslexia.

BRAINball™ is broadly adaptable across elementary and secondary grades, and while an excellent tool for physical education, it is also perfect for use in the classroom, after-school, recreation and sports programs.

Why use BRAINball™?

Developed by the University School of Physical Education, Wroclaw, Poland in 2002, BRAINball™ has almost two decades of proven research published in numerous books, research publications, and doctoral dissertations. See our website for more information. Ask us how to set up a professional development workshop at your school.

What does BRAINball™ include?

Each set includes a lesson book filled with 100 games/activities, 100 mini basketballs and soccer balls (size 3) in five colors – red, orange, yellow, blue and green – and premium equipment bags with carry strap. There are 40 yellow and 40 green basketballs with letters (upper & lower case) and numbers, 8 red and 8 blue soccer balls with math symbols, and 4 orange "wild card" (blank) balls. BRAINball™ book is not sold individually.

49082 BRAINball™ Set - 100 balls and 100 lesson plans. \$789.99 set

BRAINball™ 17 YEARS OF RESEARCH INFO GRAPH

HOW IS BRAINBALL™ PROVEN TO ENHANCE LEARNING IN CHILDREN?



STUDY #1
BRAINball™ is introduced in integrated education on reading and writing skills and physical education in students.

RESULTS
Participants recognized letters and read better.



DID YOU KNOW...

STUDY #2
First grade students use BRAINball™ to help acquire knowledge and mathematical skills.

RESULTS
By the end of the school year BRAINball™ participants had better results than their peers who didn't.

STUDY #3
BRAINball™ is used in integrated education on reading and writing for dyslexic children.

RESULTS
Students improved in dictation writing and reading with comprehension.



Students who played BRAINball™ throughout the school year opposed to those who didn't showed better results in mathematical knowledge and skills.

STUDY #4
BRAINball™ is used to help adapt students to physical exercise.

RESULTS
Results showed students had a similar level of heart rate whether they were using BRAINballs or regular play balls.

STUDY #5
The effectiveness of developing hand-eye coordination using BRAINball™.

RESULTS
When tested at the end of the school year tests showed stronger results in the right hand than the left.

Significant improvement in physical fitness and body coordination was seen in disabled children using BRAINball™.

STUDY #6
Graphomotor skills, eye- hand coordination and temporal-spatial orientation improvement.

RESULTS
Positive changes in these areas were seen in all students.

STUDY #7
Using BRAINball™ in P.E. along with subject matter from classes.

RESULTS
Those P.E. classes showed BRAINball™ helps teach basic movement and writing skills.

Dyslexic children also showed improvement in the number of words read per minute, reading with understanding, time of reading and number of errors.

BRAINball™ helps increase graphomotor skills and hand-eye coordination in participants.

Authors: Andrzej Rokita, Ireneusz Cichy, Sara Wawrzyniak, Kaczmarczyk, Krysmann, and Pawlik, Cichy at the University School of Physical Education Wrocław



EASY TO FOLLOW INSTRUCTIONS WITH VISUAL AIDS FOR QUICK TEACHING SO THERE'S MORE TIME TO LEARN!



[VIEW A SAMPLE LESSON PLAN ON OUR WEBSITE!](#)

17 YEARS OF RESEARCH PROVEN TO ENHANCE

- MATH
- READING
- SPELLING
- ADAPTED PE
- FINE MOTOR SKILLS

CREATED AND DEVELOPED AT THE UNIVERSITY SCHOOL OF PHYSICAL EDUCATION WROCLAW POLAND

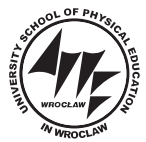

Created by: Andrzej Rokita PhD, Tadeusz Rzepa PhD and Marek Nowicki and developed by: Andrzej Rokita PhD, Ireneusz Cichy PhD, Sara Wawrzyniak PhD University School of Physical Education Wrocław, Poland

TEACHER RESOURCES

activate 2 educate

Activating the bodies of students through movement in order to Educate their minds.

The activate2educate program was developed by an award-winning teacher to maximize P.E. time by combining physical education, health, and common core into an easy to teach system that can be completed in as little as 20-25 minutes. Every a2e component is designed to be used individually or together as part of a larger classroom curriculum. See palossports.com for full program details and descriptions of all a2e products.

a2e Foundation Pack

Includes the Active Body Systems & Nutrition book which teaches 25 activities for Skeletal, Muscular, Circulatory/Respiratory, and Nervous Systems. Also comes with a comprehensive digital download that provides 287 Curriculum Cards and 29 Activity signs. Most activities use the full color cards and signs. Cards measure 4.25"W x 5.5"L. Activity Signs measure 8.5"W x 11"W. Lamination is encouraged.

16202.....\$99.99 pk.

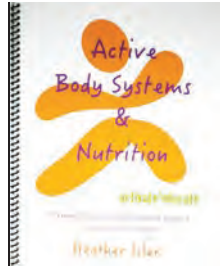

a2e 6 Ft. Body System Posters

These massive posters include labeling lines to identify parts of the body. Skeletal System poster displays front view of the bones of the body. Muscular System poster has front and back view of the muscles. Lamination is encouraged. Posters measure 2"W x 6.25'L.

16203 24 Poster Pack - 12 Muscular & 12 Skeletal. \$165.99 pk.

16204 12 Poster Pack - 6 Muscular & 6 Skeletal \$87.99 pk.

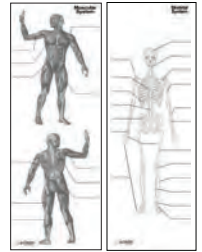

a2e Complete Curriculum Pack

The most comprehensive set available.

Includes the a2e Foundation Pack, with digital download, (12) 6ft. tall Body Posters – 6 muscular and 6 skeletal, and a complete printed set of 287 full color Curriculum Cards and 29 Activity signs. See product details above.

16201.....\$299.99 pk.

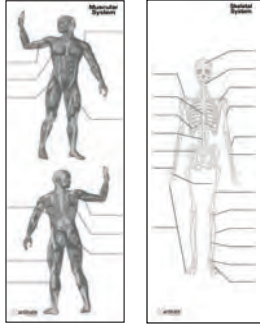

Sound Minds, Fit Bodies Activity Book

Includes games for the whole class, 2 and 6 teams, and partners. Focuses on manipulative skills, teamwork, communication, strategy, cooperation and problem solving. 28 activities geared for K-8 classes. 70 pages.

38255.....\$24.99 ea.



a2e® Skeletal... Say What?

A small group activity skeletal system and fitness activity that incorporates literacy. Hoops and skeletal body posters are arranged on a gym floor in 6 groups. Students take turns using the included spinners to identify and place bones, as well as complete exercises. Multiple variations of gameplay. Choose from two packages.

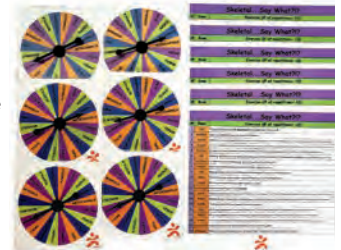

Package 1

6 skeletal spinners, 6 activity signs, 6 - 6' tall skeletal system body posters, 6 sets of K-5 location cards.

17307.....\$114.99 pk.

Package 2

6 skeletal spinners, 6 activity signs.

17308.....\$39.99 pk.

a2e® Muscular System Packages

A small group activity that focuses on Muscular System concepts and fitness activities. Various exercise stations are set up around the perimeter of a gym floor. Students are arranged in groups and use the included spinners and cards to determine muscle location and complete station exercises.

Additional equipment may be needed. Two lesson plans included. See web for more details. Choose from 2 packages.



Package 1

- 2 lesson plans, 6 muscle spinners, 6 muscular system pyramids, 6 - 6' tall muscular system body posters, 6 sets of K-5 muscle location cards.

17305.....\$116.99 pk.

Package 2

- 2 lesson plans, 6 muscle spinners, 6 muscular system pyramids.

17306.....\$46.99 pk.

a2e® All Inclusive Spinner Packages

These exclusive bundles offer you all the components from a2e's popular spinner sets – Skeletal... Say What?, Muscle Your Way Up, Workout Wheel, & Going Nuts for Nutrition – in one complete package. Choose from 2 packages based on your specific needs.

Package 1

17310.....\$237.99 pk.

- (6) Universal Spinner Sleeves
- (18) Spinner Inserts – Nutrition, Muscular, Skeletal
- (4) Lesson Plans – Going Nuts for Nutrition, Workout Wheel, Muscle Your Way Up, Skeletal Say What?

- (3) Activity Sign Sets – 6 of ea. Going Nuts for Nutrition, Muscle Your Way Up, Skeletal... Say What?

- (12) 6 ft. a2e® Body Posters – 6 ea. of Muscular & Skeletal

- (2) a2e® Location Card Bundles – 6 sets of ea. K-5 Muscle & Bone Location Cards

Package 2

* This package does not contain a2e® Body Posters or Location Cards.

17311.....\$108.99 pk.

- Everything in Package 1 (Body Posters & Location Cards not included)

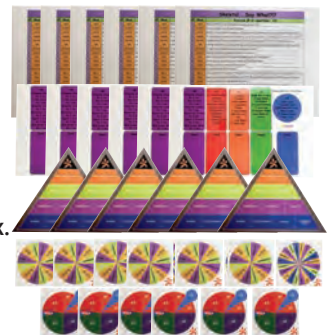

a2e® Going Nuts for Nutrition

A partner or small group activity that combines nutrition concepts, fitness, math and literacy. Cones are set up in a rectangular pattern with hoops inside. Students use included nutrition spinners and laminated activity sheets to complete exercises based on nutritional servings. Multiple variations of gameplay. Hoops and cones not included.

17309.....\$66.99 pk.

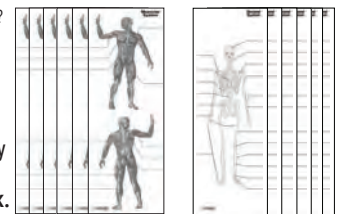

TEACHER RESOURCES



a2e Equipment Pack
Over 500 pieces of equipment!

Use these items to implement the a2e Curriculum and engage students in fun activities with meaningful lessons and outcomes. Pack includes balls, jump ropes, hoops, scooters, bean bags, fitness and assessment items and more! Visit our website for a detailed product listing.

X66543 \$2,459.99 pk.

VIDEO ONLINE

"Mother May I" Thumbball
A fun and fair way to play a classic game!

Simply toss it up, catch it and call out the command on the panel under your right thumb. Develops listening skills, increases motor skills and vocabulary, and much more in a fun way! Ball is super soft with stitched vinyl cover with activities imprinted on each panel. Ball measures 6" in diameter.



16206 \$19.99 ea.

a2e® Race to the Plate
Meets P.E. Standards 1, 3, 4 & Health 1, 4!

Small cooperative group activity focused on nutrition concepts, strategy and fitness activities. Also incorporates math and literacy. Cones are set up in a rectangular pattern, with hoops inside.

Game components are placed inside the hoops. Object is to get all 5 game pieces to the correct color on the plate via dice rolls, exercises and vocabulary matches. Includes 6 each: game boards, sets of a2e 4th & 5th grade Nutrition Vocabulary Matching Cards, activity sheets, sets of game pieces, dice, cones and hoops.

38257 \$123.99 ea.



ZONE Plaque Buster Giant Foam Toothbrush
Brushing is a BIG deal!

Fight plaque on a larger scale with this extra durable 17" long foam toothbrush. It's sure to get kids excited about oral hygiene! Not only can this be used as a health education tool, it can also be used for relay games or classroom activities.

17226 Assorted colors \$9.99 ea.



Move Mindfully Yoga Sequence Cards

Excellent visual guide in the hand or on the wall.

Set includes moves for focusing, transitioning, calming, engaging, releasing and centering. Made from heavy duty cardstock, these 4"H x 18"L cards fold easily for storage. Set of 60 cards.

52104 \$65.99 set



Exercise Cards

Ideal for the gym or classroom!

Cards have a photo on the front and step by step instructions on the reverse side. Sets include 16 heavy duty 8.5" x 11" cards with instructions and idea guide. Ages 3 and up.

52886 Yoga Cards \$24.99 set

52888 Gross Motor Exercise Cards 24.99 set



FREE LESSON PLANS FOR PE TEACHERS

PE WITH PALOS

We've created an online resource that features innovative lesson plans with great visual aids and equipment lists right at your finger tips.

Start planning at www.pewithpalos.com

PROFESSIONAL DEVELOPMENT



WITH TIM TAGGART, NATIONAL PRESENTER

Tim has over 20 years of experience in Physical Education and presenting on a national level.

WE OFFER FREE FULL DAY K-12 PROFESSIONAL DEVELOPMENT WORKSHOPS!

CONTACT US TODAY FOR DATES OF AVAILABILITY AND GET YOUR SPOT RESERVED!

*WORKSHOPS MUST BE HELD FOR THE DISTRICT AND HAVE A MINIMUM OF 40 TEACHERS PRESENT TO QUALIFY FOR A FREE WORKSHOP.

TEACHER RESOURCES



Exercise Posters

Easy to read.

Multiple images show easy to follow moves for a great workout! Laminated. 24"W x 36"L.

- | | | | |
|------------------------------------------------------|-------------|-------------------------------------------|-------------|
| 38188 Dumbbell- core, back, chest & lower body | \$23.99 ea. | 38183 Body Ball-Upper and Lower Body..... | \$23.99 ea. |
| 38189 Dumbbell- shoulder & arms | 23.99 ea. | 38184 Body Ball-Core and Lower Body | 23.99 ea. |
| 52867 Kettlebell..... | 23.99 ea. | 38192 Battle Rope..... | 23.99 ea. |



Dry Erase Boards

Write on- wipe off!

Dry erase top with a thick cardboard backing. Ideal for using with slotted cones for station markers. Measures 9"x12". Sold by the dozen. Pen not included.

38250.....\$31.99 dz.



STEM Skillastics

Add an Academic Twist by Combining Movement and STEM Questioning to Create a Balance of Learning!

An exciting resource designed to create an atmosphere of integrated learning and physical activity fun! STEM Skillastics includes 720 STEM Cards (120 questions for each team) that unite all content areas by increasing skills in standards that include speaking, reading, physical activity, math and science. Great for large groups (up to 100 can play at one time) in Physical Education or Afterschool. STEM Skillastics targets Grades 3-6. Includes 5' x 7' activity mat, 6 mini mats, 6 dice, 6 beanbags, 26 task cards, STEM cards, DVD, manual and carry bag. ⚠️ CHOKING HAZARD (1) - SMALL PARTS. Not for under 3 yrs.*

16835.....\$299.99 ea..

* Full CHOKING HAZARD descriptions on page 355.



Poster Packs- Elementary
Encouraging messages for your classes.

Excellent photography, crisp graphics and clear message.

Inspirational Sports Pack

Set of six assorted posters; Never Give Up, Attitude, The Sky is the Limit, etc.

52230 6 Poster Pack- laminated 12" x 18"\$79.99 set

Teasing & Bullying Poster Pack

Topics of respecting and accepting others, honesty, inclusion, equality, etc.

52312 10 Poster Pack- paper 17" x 22"..... 79.99 set

CLIMBING ROPES

Climbing Ropes
Choose the style for your needs!

These 1.5" climbing ropes are ideal for improving total fitness and muscular strength. All ropes include an eye fitting assembly with a quick link for easy installation. Our ropes come with a PolyBoot End which is a non-raveling leather boot permanently attached to the rope. Order our optional Turk Knot for beginner climbers.



IMPORTANT
All ropes are custom made and are non-returnable!



EYE FITTING & QUICK LINK



POLY BOOT END



TURK KNOT OPTIONAL END
Heavy knot with leather seat adds stability for an easy foot start.



RUBBER STOPS
Rubber stops every 18" assisting for intermediate climbers of 120 lbs. or lighter.



BEGINNERS KNOT
Large knots tied in the rope itself every 18" for beginner assistance.



WOVEN KNOT
Woven and spliced into rope provides assistance when descending rope.

MATS, SPOTTING AND SUPERVISION IS RECOMMENDED WHEN USING ANY OF OUR CLIMBING ROPES.

Manila	Plain-No Knots		Rubber Stops		Beginner Knots		Woven Knots	
15' Length	28200	\$139.99 ea.	28214	\$313.99 ea.	28350	\$191.99 ea.	28355	\$208.99 ea.
18' Length	28053	149.99 ea.	28215	366.99 ea.	28351	214.99 ea.	28356	235.99 ea.
20' Length	28201	157.99 ea.	28216	396.99 ea.	28352	229.99 ea.	28357	253.99 ea.
22' Length	28202	166.99 ea.	28217	426.99 ea.	28353	245.99 ea.	28358	271.99 ea.
24' Length	28203	175.99 ea.	28218	479.99 ea.	28354	266.99 ea.	28359	296.99 ea.

Polypro	Plain-No Knots		Rubber Stops		Beginner Knots		Woven Knots	
15' Length	28219	\$147.99 ea.	28239	\$304.99 ea.	28360	\$182.99 ea.	28365	\$199.99 ea.
18' Length	28220	155.99 ea.	28240	355.99 ea.	28361	203.99 ea.	28366	225.99 ea.
20' Length	28221	163.99 ea.	28241	384.99 ea.	28362	217.99 ea.	28367	241.99 ea.
22' Length	28222	170.99 ea.	28242	413.99 ea.	28363	232.99 ea.	28368	253.99 ea.
24' Length	28223	177.99 ea.	28243	464.99 ea.	28364	253.99 ea.	28369	282.99 ea.

Polyplus	Plain-No Knots		Rubber Stops		Beginner Knot		Woven Knots	
15' Length	28244	\$139.99 ea.	28264	\$313.99 ea.	28370	\$191.99 ea.	28375	\$208.99 ea.
18' Length	28245	149.99 ea.	28265	366.99 ea.	28371	214.99 ea.	28376	235.99 ea.
20' Length	28246	157.99 ea.	28266	396.99 ea.	28372	229.99 ea.	28377	253.99 ea.
22' Length	28247	166.99 ea.	28267	426.99 ea.	28373	245.99 ea.	28378	271.99 ea.
24' Length	28248	175.99 ea.	28268	479.99 ea.	28374	266.99 ea.	28379	296.99 ea.

28380 Optional Turk Knot w/Leather Seat \$19.99 ea.

WHICH ROPE IS RIGHT FOR YOU?

MANILA
Traditional superior quality 3 strand 1/2" diameter pure "grade A" manila. This natural fiber absorbs perspiration for the best grip and is extremely durable.

POLYPRO
1/2" diameter polypro material looks and feels like natural fiber rope. Superior strength at 2/3 the weight of a manila rope. Textured surface allows good grip. Popular elementary level rope-less fraying.

POLYPLUS
Soft, durable 1/2" diameter polyester outside layer feels like cotton. Lightweight polypro core for additional strength. No fray design is easy on the hands.

Climbing Rope Tambourine
Limits the climbing height.

This 20" diameter tambourine is constructed from 1/2" thick plywood and comes complete with fitting clamp for easy installation and height adjustment. The 2" diameter hole allows tambourine to slide over any 1.5" dia. climbing rope with unknotted end or over our climbing rope top fitting for adjustments down.



28106 \$47.99 ea.

Steel Adjustable Beam Clamp

Two 2.75" wide jaws and 1/2" threaded rod with self locking nuts. Fits beams with 3.5" to 12" wide flange.



28122 \$104.99 ea.

CLIMBING ROPE ACCESSORIES



Rope/Net Hoist
Hoist net or rope out of the way when not in use.

Two easily attached wall brackets with 60' of rope and weighted end. Also available is a rope metal lock box, includes 2 keys.

28057 Hoist \$113.99 ea.
28076 Lock Box w/hoist 224.99 ea.



Wood Beam Hanger

Heavy duty steel L fitting bolts onto wood beam from side and bottom dimensions.



28107 \$60.99 ea.

Quick-Link

Quick-Link is a steel clip used to attach climbing ropes to beam clamps.



28103 \$7.99 ea.

Safety Cable Attachment

A safety option that can be installed providing back-up should any ceiling hardware fail. Cable, splicers and clamp.

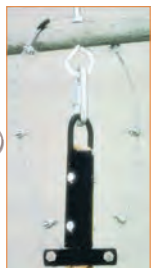

28104 \$29.99 ea.

Pipe Clamp Hanger

Steel pipe bolts onto any 3.5" O.D. pipe via threaded bolts and lock washers.



28105 \$64.99 ea.



NEW

Ninjaline® 36' Obstacle Slackline Kit

Includes 7 obstacles, portable and easy to set up. All you need is two posts or healthy trees to install one of the most versatile systems available. Set includes: 6,000lbs strength professional slackline with 14 pockets & reinforced ratchet with TPR handles, (2) 10" x 2.5" nylon rope knots, (2) 16" birch wood monkey bar holds w/triangle safety carabiners, 2 steel gym rings with ABS textured finish, and 1 traverse ring. Move them further apart or add unique obstacles like the Skate Swing as you get better. Ages 5+. Max weight 250 lbs. Adult supervision required.

28421 \$99.99 ea.



CLIMBING



NEW

Slackers® Ricketty Bridge

Mimics the challenge of the "broken bridge" in play pattern.

Challenges balance and focus while giving upper arms a break. Secures to a Ninjaline® with included carabiners. Add multiples for an extended challenge and more fun. Made of PE UV resistant rope and 6 powder coated steel adjustable bars. Adult supervision required.

28420 Ninjaline not included..... \$49.99 ea.



NEW

Slackers® Skate Swing

Part skateboard, part swing, all fun.

The wooden skateboard-like base has a prism design and a non-slip foam top. The wood hand holds are easily adjustable. Easily secures to a Ninjaline® with included reinforcement straps. May also be attached to a healthy tree or play structure with the included adjustable rope and 2 carabiners. For ages 5 and up; maximum weight 250 lbs. Adult supervision required.

28419 Ninjaline not included..... \$64.99 ea.

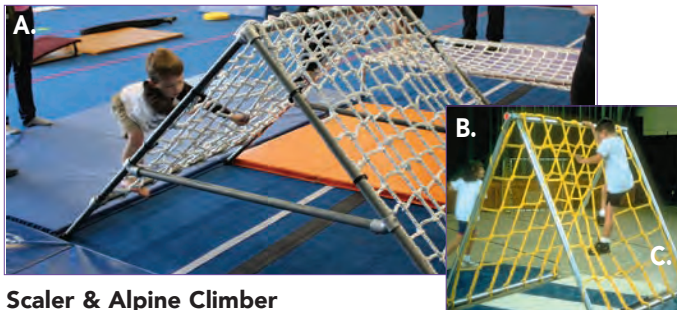

Scaler & Alpine Climber

Basic climbing; ideal for small spaces.

Easy to fold up and store. Scalers have a 2" O.D. steel frame with rubber floor guards, optional 9" or 12" twisted ½" poly dacron netting and a climbing area of 6'x 6' per side. The Alpine Climber has a 1" O.D. steel frame, 4" netting and a climbing area of 4' x 4' per side. Both units include rubber floor guards and top and side lashings.

X28414 A- Alpine Climber w/4"W x 8'L frame & 4" mesh netting \$ 1,599.99 ea.

X28102 B- Scaler w/6' x 10'L frame & 12" mesh netting 1,319.99 **SALE 1,287.97 ea.**

X28413 B- Scaler w/6' x 10'L frame & 9" mesh netting 1,449.99 ea.

Spider Web Nets

A unique climbing challenge! Fabricated using ¾" diameter 3 strand poly dacron rope and features an 18" diameter center with outward circles spaced a foot apart. Square border ties the net together, has 4" eye loops on top for hanging. Available in black or white in 3 sizes. Nets are all custom made and non-returnable.



28407 White 8' x 8' \$725.99 ea. 28410 Black 8' x 8' \$725.99 ea.
 28408 White 10' x 10' 850.99 ea. 28411 Black 10' x 10' 851.99 ea.
 28409 White 12' x 12' 966.99 ea. 28412 Black 12' x 12' 966.99 ea.



X16691
8'6" Bar

8'x 8' Net Sold Separately

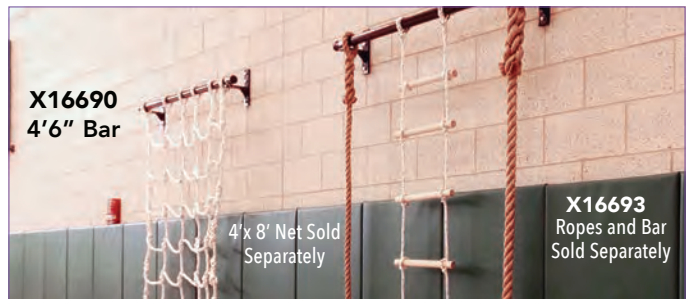

X16690
4'6" Bar

4'x 8' Net Sold Separately

X16693
Ropes and Bar Sold Separately

Hanging Bar Systems

Unique anchoring system for climbing ropes, ladders or suspension trainers. Easy to install, includes bar brackets and bolts. Bar projects 6" from wall when installed. Ladders, ropes and nets sold separately

X16690 4'6" Bar with 2 wall brackets (net sold separately).....\$218.99 ea.

X16691 8'6" Bar with 3 wall brackets (net sold separately) 321.99 ea.

T16692 12'6" Bar with 4 wall brackets-(net sold separately) ships by truck 423.99 ea.

X16693 8' Ladder with 12' spacing (ropes and bar sold separately) 274.99 ea.

X16694 8' Poly Dacron Rope; 1.25" diameter..... 81.99 ea.

X16846 4'x 8' Poly Dacron 9" Net-9" Mesh 277.99 ea.

X16847 8'x 8' Poly Dacron 9" Net-9" Mesh 502.99 ea.

IMPORTANT-All ropes on this page are custom made and are non-returnable!

CLIMBING NETS

Heavy Duty Cargo Climbing Nets

With 4" diameter eye loops for attaching!
Flexible yet rugged with 3 strand 3/4" non-stretch polypro rope using a 3 pass weave for ultimate toughness. For safety, use mats, spotter and adult supervision. Two sizes, available 11" square and now 9" square for younger ages. Indoor use only.



SIZE	WEIGHT	11" SQUARE MESH	WEIGHT	9" SQUARE MESH
10'W x 10'H	35 lbs.	X28140	\$493.99 ea.	49 lbs. X28144 \$601.99 ea.
12'W x 12'H	48 lbs.	X28141	671.99 ea.	67 lbs. X28145 833.99 ea.
12'W x 14'H	55 lbs.	X28142	747.99 ea.	77 lbs. X28146 1,024.99 ea.
12'W x 18'H	70 lbs.	X28143	972.99 ea.	

Outdoor Cargo Climbing Nets
You make the frame—we've got the net!

High grade 3 strand twisted black polypropylene with UV resistance in either 3/4" or 1" diameter. All nets comply with National Playground Safety Standards



regarding appropriate mesh sizes and locking mesh junctions. Install on structurally safe framework with special considerations to safe heights, safe use and appropriate landing surfaces. Supply us with your dimensions (H x W'). Minimum order is 30 square feet per net.

- X28150** 12" Mesh with 3/4" diameter per square foot **\$5.29 sq. ft.**
- X28151** 12" Mesh with 1" diameter per square foot **8.99 sq. ft.**



Net Installation Kit
Suspends bar up to 10' from ceiling beams.

Adaptable to 10', 12' and 14' wide cargo nets. Includes: Telescoping Hanging Bar, 5 beam clamps, eyebolts and chain connectors. Ships by truck.



- T28147** Installation Kit: bar, beam clamps, eyebolts & accessories **\$1,404.99 kit**
- T28148** Telescoping Hanging Bar **453.99 ea.**

Peg Board Climbers
Made of hard maple.

Mount singly, in blocks, or as many as you wish. Arrange them in any shape or pattern. Hand made and hand finished, triple coated varnish with machine drilled holes. Two size boards; 6'L x 6"W & 1.5" thick or 6'L x 12"W & 1.5" thick. Each board comes with one pair of pegs. Mounting kit for concrete or brick is additional.



- X28012** 29 holes 6' x 6" **\$179.99 ea.**
- X28016** 38 holes 6' x 12" **299.99 ea.**
- X28018** Mt. Kit for above 6" Wide Boards **72.99 ea.**
- X28019** Mt. Kit for above 12" Wide Boards **77.99 ea.**

Cargo Climbing Nets

Non-slip weave for extra safety!

Featuring 3/4" diameter poly rope with 1/2" diameter poly rope vertical lanyards for better grip and maximum strength. Lightweight for hoisting with 4' connecting lanyards yet extremely durable! For safety, use mats, spotters and adult supervision. Two sizes, available 12" square and now 9" square for younger ages. For indoor use only.



SIZE	WEIGHT	12" SQUARE MESH	WEIGHT	9" SQUARE MESH
10'W x 10'H	23 lbs.	X28041	\$313.99 ea.	24 lbs. X28095 \$449.99 ea.
12'W x 12'H	26 lbs.	X28042	421.99 ea.	32 lbs. X28096 593.99 ea.
12'W x 14'H	31 lbs.	X28043	490.99 ea.	38 lbs. X28097 667.99 ea.
12'W x 18'H	39 lbs.	X28044	612.99 ea.	
14'W x 18'H	46 lbs.	X28046	729.99 ea.	



Tunnel Nets with Frame

Walk, crawl, squeeze or step through the specially designed tunnel net.

Teaches body control against a moveable force. Easily installed onto the 2" O.D. steel frame featuring non-marring rubber feet and a unique fold down design for storage. Tunnel net constructed of quality 3/4" diameter 3 strand twisted polypropylene rope with 9" or 12" square mesh openings. Tunnel frame measures 5'H x 6'W x 10'L.

- X28152** 12" mesh netting **\$1,319.99** **SALE \$1,287.97 ea.**
- X28153** 9" mesh netting **1,460.99** **SALE 1,398.97 ea.**

Outdoor Climbing Ropes

One of the best gripping synthetic ropes that holds up well to abrasion.

Fabricated from quality 1.5" diameter polyester dacron blend with excellent moisture and UV resistance. Each top has a galvanized metal thimble for superior strength and each bottom is braided to deter unraveling. Custom order a rope by adding extra footage. Additional charge for adding knots- specify location.

- 28400** 24' White Polydac Rope **\$195.99 ea.**
- 28405** 24' Black Polydac Rope 2" Diameter **351.99 ea.**
- 28401** 15' White Polydac Rope **159.99 ea.**
- 28402** 8' White Polydac Rope **150.99 ea.**
- 28403** Additional 1 1/2' Foot Polydac Rope **4.99 ea.**
- 28404** Chainlink w/Quicklink **31.99 ea.**
- 28380** Optional Turk Knot w/Leather seat **19.99 ea.**



IMPORTANT-All ropes on this page are custom made and are non-returnable!

HORIZONTAL CLIMBING WALLS

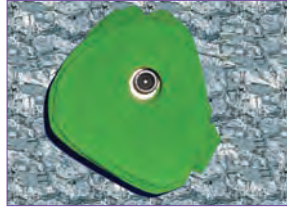

Neoprene Rock Climbing Wall Packages

With an amazing neoprene cover!

Neoprene makes the wall safer and eliminates scratches on arms and legs from rough textured paint! Features a realistic mountain design with trees that act as the safety zone where students' feet are not allowed to leave. Panels are made from 3/4" thick plywood with screw on T-nuts that will not pop off the back of the panel and a 6mm thick neoprene cover. Each panel has 60 mounting hold options to change the route often. With a neoprene cover, there is no paint to peel off if climbing holds are over tightened. We recommend to always use mats when climbing on the walls and cover the walls when not in use to prevent unsupervised climbing. 1 Year Warranty. Ships by truck. Call for freight quote- our normal shipping policy does not apply to these items.



Climbing Walls with Easy Lock Mat System

- C28195 8'H x 20' Long Wall w/5 panels & 100 holds; 820 lbs. \$4,499.99 set
- C28196 8'H x 40' Long Wall w/10 panels & 200 holds; 1410 lbs. 6,699.99 set
- C28197 10'H x 20' Long Wall w/5 panels & 125 holds; 920 lbs. 4,749.99 set
- C28198 10'H x 40' Long Wall w/10 panels & 250 holds; 1610 lbs. 6,799.99 set

Climbing Walls without Easy Lock Mat System

- C28270 8'H x 4' Long Panel w/20 holds; 131 lbs. \$499.99 ea.
- C28271 10'H x 4' Long Panel w/25 holds; 151 lbs. 599.99 ea.
- C28272 8'H x 20' Long Wall w/5 panels & 100 holds; 655 lbs. 2,199.99 set
- C28273 8'H x 40' Long Wall w/10 panels & 200 holds; 1310 lbs. 4,099.99 set
- C28274 10'H x 20' Long Wall w/5 panels & 125 holds; 700 lbs. 2,499.99 set
- C28275 10'H x 40' Long Wall w/10 panels & 250 holds; 1400 lbs. 4,499.99 set



Easy Lock Mat Locking System

Use on your existing climbing wall!



Mats are 3" thick with a foam link padding and durable blue 18 ounce foam retardant cover. Simply press the two included side release buckles together to lock the mats in place, then lock with the turn of a key. No more stringing cable! Mats can be removed completely for use in tumbling activities. Ships by truck. Call for freight quote- our normal shipping policy does not apply to these items.

- C28276 6'H x 4' Long Mat; 30 lbs. \$486.99 ea.
- C28277 6'H x 20' Long Mat System; 150 lbs. 2,299.99 set
- C28278 6'H x 40' Long Mat System; 300 lbs. 3,849.99 set

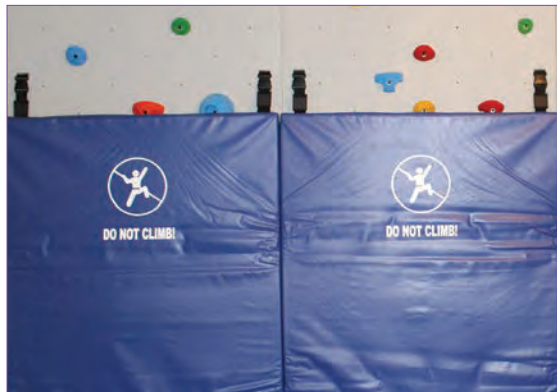

Painted Traverse Climbing Walls

High quality wall packages at economical prices!

Panels are made from 3/4" thick plywood with screw on T-nuts that won't pop off the back of the panel. Features a high quality, colorful painted scene and a variety of pre-drilled holes for multiple traverse climbing paths. The 8'H panels have 60 pre-drilled holes and the 10'H panels have 74 pre-drilled holes. Walls come with or without Easy Lock Mat System. Normal delivery time is 2-3 weeks. Call for freight quote- our normal shipping policy does not apply to these items.

8'H Climbing Walls without Easy Lock Mat System

- C28533 8'H x 4' Long Panel w/ 20 holds \$465.99 ea.
- C28534 8'H x 20' Long Wall w/ 100 holds..... 2,230.99 set
- C28535 8'H x 40' Long Wall w/ 200 holds..... 3,780.99 set

10'H Climbing Walls without Easy Lock Mat System

- C28536 10'H x 4' Long Panel w/ 25 holds \$599.99 ea.
- C28537 10'H x 20' Long Wall w/ 125 holds..... 2,750.99 set
- C28538 10'H x 40' Long Wall w/ 250 holds..... 4,149.99 set

8'H Climbing Walls with Easy Lock Mat System

- C28539 8'H x 20' Long Wall w/ 100 holds & Mat \$3,199.99 set
- C28540 8'H 40' Long Wall w/ 200 holds & Mat 6,049.99 set

10'H Climbing Walls with Easy Lock Mat System

- C28541 10'H x 20' Long Wall w/ 125 holds & Mat \$3,399.99 set
- C28542 10'H x 40' Long Wall w/ 250 holds & Mat 6,299.99 set

HORIZONTAL CLIMBING WALLS



Hoop Holders
A great climb through challenge!

Mounts to your climbing wall and climbers can crawl through, above, below or around! Set of 5 hoop holders mount directly to your wall. Hoops not included.

X28312 \$89.99 set

Challenge Course

Form loops, lines and starburst obstacles for students to climb over, under and through!

Specially designed holds allow you to attach foam noodles of various sizes to create unique patterns and paths to challenge climbing wall users. You can even put balls on the holds! Set includes: 6 small noodle resin holds, 6 large quintuple noodle resin holds, 30 foam noodles (6-72", 10-18" & 14-12"), 5 activity balls, mounting hardware and 5 fun and exciting sample activities.

X28068 \$361.00 set

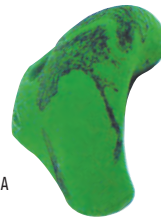

Climbing Wall Holds

These hand holds are bolt on style and made from high impact, textured resin.

X28156 A. Large Beginner Holds; Green, set of 10 \$99.99 set

X28157 B. Medium Intermediate Holds; Yellow, set of 10 85.99 set

X28158 C. Small Advanced Holds; Red, set of 10 59.99 set



The Total Traverse Wall Package

In 20' or 40' lengths!

You get everything you need with this package- the panels, relief safety line, the hand holds, the special ball holders, the T-nuts, wall sign, instructions and the new Cordless Mat Locking System! No need to run cables with this 2 in 1 system- just attach the patent pending mat locking holds and you're ready to go! The foam filled 2" thick mats affix quickly and easily at the base of the floor. Normal delivery time is generally 4-6 weeks. Call for freight quote- our regular shipping policy does not apply to this product.

The 20' Total Traverse Wall Package

Includes: 5 standard 4'W x 8'L traverse wall panels, 100 climbing holds, 10 ball holders, 320 T-nuts, red relief line, wall sign and instructions. Your choice with or without 20' Cordless Mat Locking System with 2" thick mats.

Mats available in red or royal. Specify color.

C28112 20' Total Traverse Wall Package with Mats \$3,544.00 set

C28178 20' Total Traverse Wall Package without Mats 2,572.00 set

The 40' Total Traverse Wall Package

Includes: 10 standard 4'W x 8'L traverse wall panels, 200 climbing holds, 10 ball holders, 640 T-nuts, red relief line, wall sign and instructions. Your choice with or without 40' Cordless Mat Locking System with 2" thick mats.

Mats available in red or royal. Specify color.

C28113 40' Total Traverse Wall Package with Mats \$6,976.00 set

C28179 40' Total Traverse Wall Package without Mats 5,202.00 set

GYMNASTICS

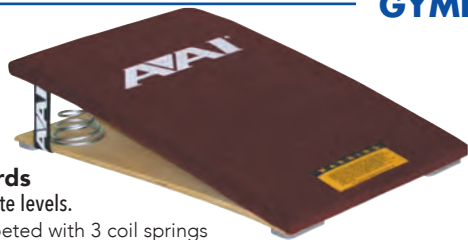

AAI® Vaulting Boards

For beginners through elite levels.

The junior board is carpeted with 3 coil springs designed for users under 85 lbs. The 8 coil board has 8 coils and is adjustable to meet the weight and ability needs of beginners to advanced level gymnasts. 200 lb. weight limit.

- X45039 8 Coil Board.....\$945.00 ea.
- X45006 Junior Vaulting Board 354.99 ea.



Gibson® Mile High Spring Board

Adjustable tension for a variety of gymnasts!

Made with, heavy-duty .25-inch chromium-plated music wire springs and 1/4" maple top that allows for more flex, thus more spring. Surface is padded with 3/4" closed cell cross-linked foam and covered with high quality carpeting. Rubber pads prevent marring of floor and increased traction.

The 20cm (8") eight-spring board meets all FIG, USAG, NCAA and high school specifications for men's or women's programs.

- X45032\$584.99 ea.



Suede Beams

Your choice of 8' or 12' lengths.

Layer of cross-linked foam is laminated to the top surface of the beam for cushioning.

- X45041 8' x approx. 7"H\$249.99 ea.
- T45042 12' x 12"H: Ships by Truck 599.99 ea.



Low Balance Beam

Ideal for teaching beginning balance beam activities.

Beam is made of steel. Unit is 12" high and rests on sturdy steel bases finished in metallic blue with suede-like material covering. Ships by truck.

- T45021\$940.00 ea.



AAI® Beginner Balance Beams

Two styles ideal for teaching early fundamentals!

Both beams are 4" wide, tapered to the floor for added stability and have polyethylene foam cores. The TAC/10 cover provides easy cleaning with excellent grip and durability. The suede cover provides an authentic balance beam feel. Both beams measure 106"L x 4"W x 2"H.

- X45060 TAC/10 Balance Beam.....\$199.99 ea.
- X45061 Suede Cover Balance Beam..... 176.99 ea.

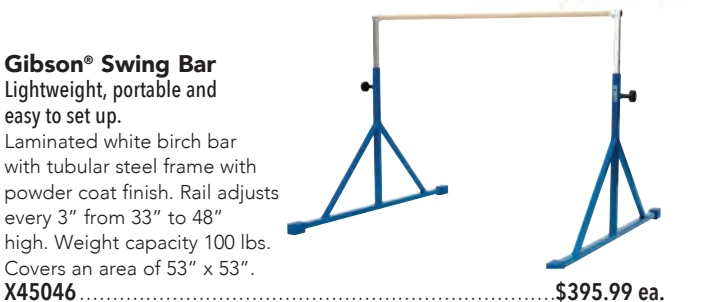

Gibson® Swing Bar

Lightweight, portable and easy to set up.

Laminated white birch bar with tubular steel frame with powder coat finish. Rail adjusts every 3" from 33" to 48" high. Weight capacity 100 lbs. Covers an area of 53" x 53".

- X45046\$395.99 ea.



Foam Wedges

The wedge is ideal for teaching pre-schoolers high and low, or use as a gymnastic tumbling aid.

Constructed of high density poly foam and covered in a durable 13 oz. fire retardant, mildew resistant vinyl.

- X29150 36"L x 24"W x 12"H Blue\$153.99 ea.
- X29151 48"L x 24"W x 12"H Blue 201.99 ea.
- T29152 72"L x 36"W x 16"H Red, ships by truck 276.99 ea.

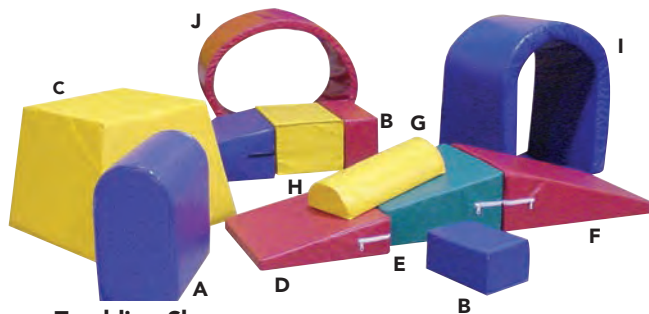

Foam Tumbling Shapes

The perfect tools for teaching tumbling progressions!

Teach proper form, improve balance and coordination and use for children to build and combine shapes to create their own play environments! Made with a high density urethane foam with a 14 oz. laminated vinyl over nylon scrim covering that is fire retardant, withstands scrubbing and is anti-bacterial. Sold as a complete set or individually. All shapes are custom ordered and are non-returnable.

- T29159 Complete 10 Piece Foam Shape Set: Ships by Truck.....\$1,345.99 set
- X29160 (A) Dome 24"L x 12"W x 24"H..... 122.99 ea.
- X29161 (B) Small Block 12"L x 8"W x 6"H..... 54.99 ea.
- X29162 (C) Pyramid Base 24"L x 24"W x 24"H w/tapered sides..... 230.99 ea.
- X29163 (D) Small Wedge 24"L x 24"W x 1-6"..... 69.99 ea.
- X29164 (E) Medium Wedge 24"L x 24"W x 1-12"..... 102.99 ea.
- X29165 (F) Large Wedge 48"L x 24"W x 6-12"..... 196.99 ea.
- X29166 (G) Half Round Shape 24" x 12"W x 6"H..... 74.99 ea.
- X29167 (H) Medium Block 24"L x 12"W x 12"H..... 75.99 ea.
- X29168 (I) Tunnel 24"L x 24"W x 30"H 183.99 ea.
- X29169 (J) Open Cylinder 24"W x 30" diameter 182.99 ea.

Gym Chalk

Get a grip!

Fine quality, ideal for weight lifting, climbing walls or gymnastics. Wrapped in 2 oz. blocks, 8 blocks per pound.

- 52306\$11.99 lb.



FOAM SHAPES



UCS® Combo Boxes

A trapezoid, horse and skill builder all in one!

The three piece top unit can be used in various combinations to develop strength and balancing skills. Removing the individual blocks creates a three section trapezoid. Made from high density polyurethane with a 21 oz. knife coated vinyl cover and 2" Velcro® flaps to hold sections securely in place. Specify a solid color or alternating colors. Ships by truck.

- T45069 36" x 36" x 36" (specify color)..... \$905.99 ea.
- T45070 48" x 48" x 48" (specify color)..... 1,298.99 ea.



UCS® Super Folding Incline Mats

Teach the basics as well as the advanced competitive skills.

Used as rotational aides, landing mats and crash pads. Made with a high density prime foam and 21 oz. knife coated vinyl cover. Specify body and side colors. Ships by truck.

- T29135 48" x 72" x 16"-2" (specify color)..... \$591.99 ea.
- T29136 60" x 120" x 22"-2" (specify color)..... 1,288.99 ea.
- T29137 72" x 144" x 22"-2" (specify color)..... 1,373.99 ea.



UCS® Rainbow Barrel

Excellent for developing balance, alertness and coordination!

Use for a variety of games such as barrel rolling, races, or place the barrel in an upright position for bean bag tossing. Made from densely compacted foam with a heavy duty 21 oz. knife coated vinyl. Measures 32" x 40". Ships by truck.

- T45065..... \$735.99 ea.



UCS® Plugs

A great way to increase physical activity!

Excellent for motor skill development and a perfect tool for any program! Dense foam core with thick vinyl cover.

- X45071 18" x 30" diameter (specify color) \$313.99 ea.
- X45072 30" x 30" diameter (specify color) 423.99 ea.
- X45073 30" x 36" diameter (specify color) 496.99 ea.

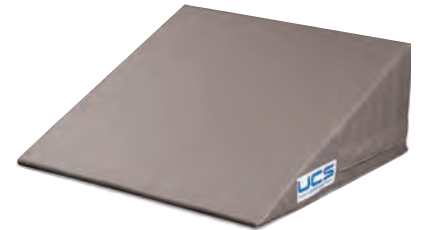

UCS® Solid Wedges

Use for hurdling, tumbling, rolling, spotting, physical therapy and exercise.

One piece of 100 ILD urethane foam with a 21 oz. knife coated vinyl cover. See color chart below for color options. Specify Color.

- X45066 20" x 30" x 6" (specify color) \$144.99 ea.
- X45067 30" x 30" x 12" (specify color) 185.99 ea.
- T45068 40" x 30" x 16" (specify color) Ships by Truck 213.99 ea.



UCS® Trapezoids

Use as a vaulting horse or spotting platform.

Firm enough for developing basic motor and gymnastic skills. Constructed polyurethane foam with knife coated 21 oz. vinyl and 2" Velcro® flaps that secure the sections in place. Available in 2 sizes 36" x 36" x 36" (#T45024) and 48" x 48" x 48" (#T45023) Specify colors. Ships by truck.

- T45024 Spfy color \$989.99 ea.
- T45023 Spfy color 1,219.99 ea.



UCS® Split Octagons

Fresh twist on the Octagonal Spot Trainer!

Attach and detach using Velcro® stripping on the two ends. Fasten together and they form an Octagonal Spot Trainer to teach tumbling. Made from high density polyurethane foam and vinyl covering. Measures 25"W x 25"H x 30"L.

- X45062 Specify color \$358.99 ea.



UCS® Octagonal Spot Trainer

One of the most popular items used for increasing motor skill development!

Use to teach gymnasts, cheerleaders and tumblers the perfect form! Made from high density foam with a 21 oz. knife coated vinyl cover. Specify body and side colors. Ships by truck.

- T45074 25" x 25" x 36" (specify color) \$370.99 ea.
- T45075 30" x 30" x 36" (specify color) 417.99 ea.
- T45076 35" x 35" x 40" (specify color) 594.99 ea.
- T45077 40" x 40" x 40" (specify color) 720.99 ea.



ALL USC FOAM SHAPES ARE CUSTOM MADE AND ARE NON-RETURNABLE

WHICH MAT IS RIGHT FOR YOU?

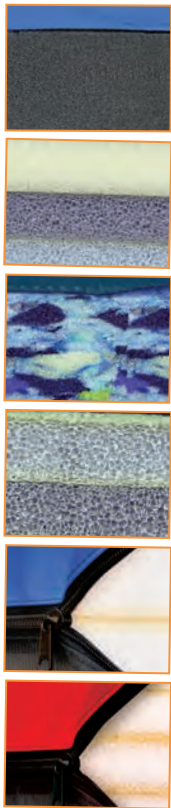

FOAM TYPE	THICKNESS	FIRMNESS	ABSORPTION	4'x8' MAT WEIGHT	USES
URETHANE FOAM	2"	SOFT	LOW	24 LBS.	Soft and lightweight, recommended for very young children and lower Elementary
CROSS-LINKED FOAM	2-3/8"	SEMI-SOFT	MEDIUM	28 LBS.	All purpose, great for younger children. Recommended for upper Elementary
BONDED FOAM	2"	SEMI-FIRM	MEDIUM	45 LBS.	Perfect for exercising or low impact gymnastics. Recommended for Jr. High
CROSS-LINKED FOAM	1-3/8"	FIRM	HIGH	20 LBS.	Great for physical education, gymnastics, & more. Recommended for High School
URETHANE FOAM	VARIES 6"-12"	SEMI-FIRM	HIGH	70 LBS. (12")	Excellent for crash pad, under climbing walls, ropes and more
CROSS-LINKED FOAM	VARIES 6"-12"	VERY FIRM	HIGH	72 LBS. (12")	Use for tumbling, martial arts and physical education activities

ALL MATS ARE FIRE RETARDANT & BACTERIA RESISTANT

Note: All mats are considered custom and are non-returnable. Actual colors may vary from swatches.



AAI E-Z Roll Carpet Mat

Foam is scored for easier rolling!

Permanently bonded, 1 3/4" cross linked polyethylene foam provides superior shock absorption and longevity. Foam back is scored every 4" to provide an easy non-binding roll for simple set up and take down. Rolls out in 6' x 42' sections, standard 42' x 42' or create your own design. Rolls connect with hook fasteners for a safe, seamless finish. Fasteners included with 42' x 42' mats or can be purchased separately. Royal blue only. Ships by Truck.

- T29215 6"W x 42'L Roll with fastener \$799.99 **SALE \$749.97 ea.**
- T29216 42' x 42' Mat with fasteners 5,899.99 **SALE 5,141.97 ea.**
- 29217 Fastener Section 43.5' x 4" roll (mat not included) 39.99 ea.

SPECIAL
INCLUDES HEAVY DUTY
14 OZ. 80/20 COATED COVER

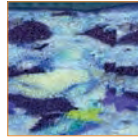

48 HOUR QUICK SHIP

REBONDED FOAM	2"	FIRM
---------------	----	------

TruMAT™ 2" Bonded Foam Mat

- Royal Blue mats only, 2 foot folding panels for storage
- 14 oz. laminate cover; mildew, bacteria and UV treated, fire retardant
- Ships from the manufacturer in 48 hours, arrival time may vary to location.
- 5' x 10' Mats ship by Truck.

Description	VELCRO® ON 2 ENDS		VELCRO® ON 4 ENDS	
4'x6'	X29491	\$188.99 ea.	X29494	\$193.99 ea.
4'x8'	X29492	247.99 ea.	X29495	273.99 ea.
5'x10'	T29493	378.99 ea.	T29496	419.99 ea.

SPECIAL
INCLUDES HEAVY DUTY
18 OZ. 80/20 COATED COVER

CROSS-LINKED FOAM	1-3/8"	FIRM
-------------------	--------	------

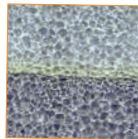

48 HOUR QUICK SHIP

TruMAT™ 1-3/8" Cross-Linked Polyethylene Foam Mat

- Royal Blue mats only, 2 foot folding panels for storage
- 18 oz. laminate cover; mildew, bacteria and UV treated, fire retardant
- Ships from the manufacturer in 48 hours, arrival time may vary to location.
- 5' x 10' Mats ship by Truck.



Description	VELCRO® ON 2 ENDS		
4'x6'	X29284	\$179.99 ea.	SALE \$170.97 ea.
4'x8'	X29285	236.99 ea.	SALE 224.97 ea.
5'x10'	T29286	369.99 ea.	SALE 352.97 ea.

Description	VELCRO® ON 4 ENDS		
4'x6'	X29184	\$209.99 ea.	SALE \$199.97 ea.
4'x8'	X29185	264.99 ea.	SALE 251.97 ea.
5'x10'	T29186	404.99 ea.	SALE 385.97 ea.

SPECIAL
INCLUDES HEAVY DUTY
18 OZ. 80/20 COATED COVER



URETHANE FOAM	2"	SOFT
---------------	----	------

TruMAT™ 2" Urethane Foam Folding Mat

- Royal Blue mats only, 2 foot folding panels for storage
- 18 oz. laminate cover; mildew, bacteria and UV treated, fire retardant
- Ships from the manufacturer in 48 hours, arrival time may vary to location.
- 5' x 10' Mats ship by Truck.

Description	VELCRO® ON 2 ENDS		VELCRO® ON 4 ENDS	
4'x6'	X29293	\$187.99 ea.	X29488	\$194.99 ea.
4'x8'	X29298	227.99 ea.	X29489	254.99 ea.
5'x10'	T29299	349.99 ea.	T29490	395.99 ea.

URETHANE FOAM	2"	SOFT
---------------	----	------



TruMAT™ 2" Urethane Primary Color Foam Folding Mat

- Red/blue/yellow/green, 2 foot folding panels for storage
- 18 oz. laminate cover; mildew, bacteria and UV treated, fire retardant
- Ships from the manufacturer in 48 hours, arrival time may vary to location.
- X29099 4' x 8' Velcro on 2 ends \$209.99 ea.

SPECIAL
INCLUDES HEAVY DUTY
18 OZ. 80/20 COATED COVER



48 HOUR QUICK SHIP

ALL MATS ARE CUSTOM MADE AND ARE NON-RETURNABLE

FOLDING MATS

Note: All mats are considered custom and are non-returnable. Actual colors may vary from swatches.



CROSS-LINKED FOAM	2-3/8"	SEMI-SOFT
-------------------	--------	-----------

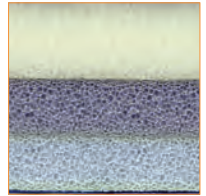

CROSS-LINKED FOAM	1-3/8"	FIRM
-------------------	--------	------

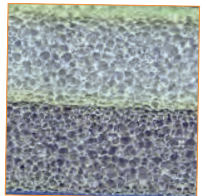

TruMat™ Championship Series Folding Mat

Provides excellent support and traction for medium/high impact activities!

- Heavy duty 18 oz. 80/20 textured vinyl cover- 80% on finished side
- Mats fold in 2' sections with Velcro® on 2 or 4 sides
- Reinforced stitched seams
- Flame-resistant and washable
- Available in royal, black, red, forest green or yellow, please specify color
- "T" Items Ship by Truck

HEAVY DUTY 18 OZ., 80/20 TEXTURED VINYL COVER, 80% ON FINISHED SIDE

Description	Velcro® On 2 Ends						Velcro® On 4 Ends					
	1-3/8"			2-3/8"			1-3/8"			2-3/8"		
	Item #	Each	SALE	Item #	Each	SALE	Item #	Each	SALE	Item #	Each	SALE
4'x6'	X29472	\$196.99	\$186.97	X29480	\$290.99	\$275.97	X29476	\$229.99	\$218.97	X29484	\$315.99	\$299.97
4'x8'	X29473	258.99	246.97	X29481	372.99	354.97	X29477	289.99	274.97	X29485	399.99	378.97
5'x10'	T29474	404.99	394.97	T29482	572.99	544.97	T29478	443.99	421.97	T29486	603.99	573.97
6'x12'	T29475	556.99	529.97	T29483	799.99	759.97	T29479	532.99	505.97	T29487	828.99	788.97

CROSS-LINKED FOAM	1-3/8"	FIRM
-------------------	--------	------

Folding FBC Mats

Foam backed carpet mats- now folds flat for storage!

If you don't have the room to store rolls of carpeted mats, here's what you need! Permanently bonded 1 1/2" cross linked foam with top grade prime polyethylene provides superior shock absorption and long lasting life. Here's the two best features- mats fold for storage and you can customize these mats to fit your space or around obstacles by simply cutting them with a utility knife. Available in 4 sizes. Blue only. Fastener sections connect mats together with the 4" wide by 1 yard roll of carpeted Velcro® sold separately. "T" Items Ship by Truck

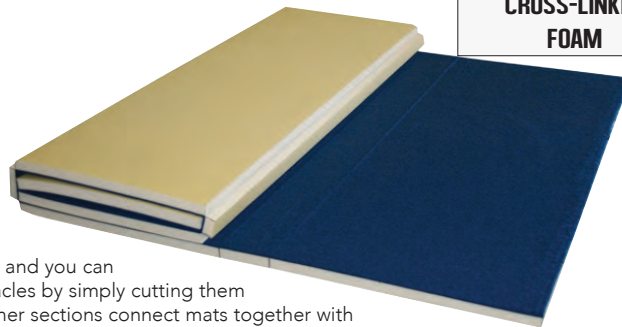

X29219 4' x 6'	\$119.99 ea.
X29220 6' x 8'	235.99 ea.
T29221 6' x 10'	294.99ea.
T29222 6' x 12'	309.99 ea.
29217 Fastener Section 43.5' x 4" roll (mat not included).....	39.99 ea.

Mat Truck For Folding Mats

Holds any 2' wide by 6' long mat!

The .75" vinyl covered plywood platform is supported by a 1.75" steel tubing. Truck has easy to push handle and non-marring wheels. Measures 72"L x 24"W.



X29098\$399.99 ea.



MAKES 64 GALLONS OF CLEANING SOLUTION!

Matt-Kleen

Cleans, sanitizes and disinfects all types of non-porous surfaces. Just add 2oz. to 1 gallon of water to create a powerful solution.

46002 \$58.99 ea.

FOLDING MATS

Note: All mats are considered custom and are non-returnable. Actual colors may vary from swatches.

URETHANE FOAM	2"	SOFT
------------------	----	------

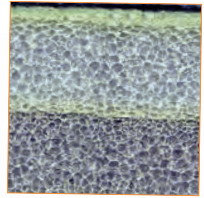

NOW WITH A 18 OZ. PREMIUM COATED EXTREMELY DURABLE COVER!

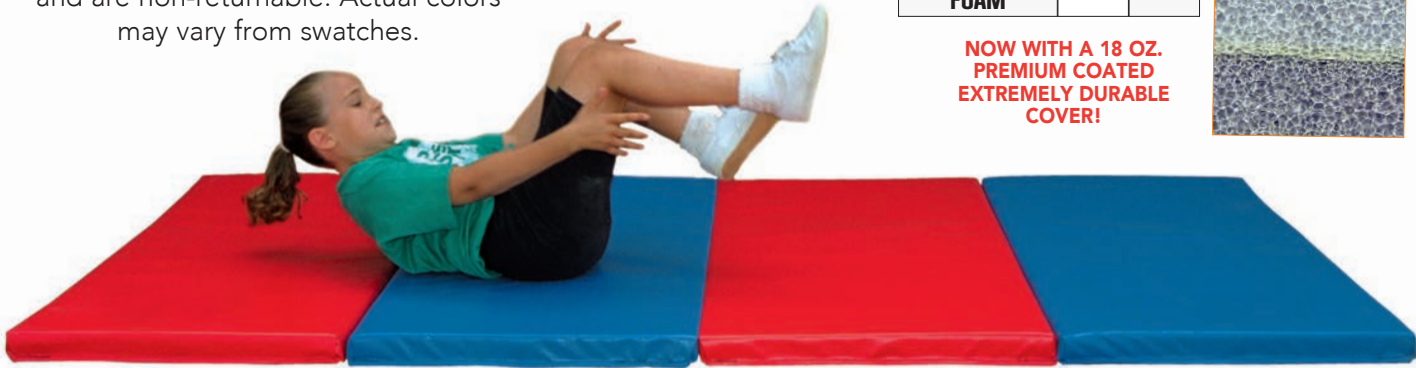

TruMAT™ 2" Urethane Foam Folding Mat

Soft and lightweight for smaller children!

- 2" urethane foam
- 18 oz. 80/20 coated cover (80% on finished side)
- 2' folding panels for easy folding and storage
- Mildew, bacteria & UV treated

- Fire retardant; ASTM E84 approved
- Recommended up to 4th grade
- Order in solid or alternating panel colors; please specify
- "T" Items Ship by Truck

Description	No Velcro®		Velcro® On 2 Ends		Velcro® On 4 Sides	
	Item #	Each	Item #	Each	Item #	Each
4'x6'	X29057	\$196.99	X29061	\$187.99	X29065	\$192.99
4'x8'	X29058	227.99	X29062	227.99	X29066	254.99
5'x10'	T29059	349.99	T29063	369.99	T29067	388.99
6'x12'	T29060	499.99	T29064	519.99	T29068	539.99

IN A RUSH?

Mats are custom made for your size and color(s). Normal delivery is 1-2 weeks. If you need faster service call Customer Care and they will assist you with faster service at NO EXTRA CHARGE.

CROSS-LINKED FOAM	1-3/8"	FIRM
----------------------	--------	------



NOW WITH A 18 OZ. PREMIUM COATED EXTREMELY DURABLE COVER!



TruMAT™ 1-3/8" Cross-Linked Polyethylene Foam Mat

All purpose high impact tumbling, gymnastics and martial arts mat.

- Two 3/4" thick pieces of bonded polyethylene foam
- 18 oz. 80/20 coated cover (80% on finished side)
- 2' folding panels for easy folding and storage
- Absorbs shock without bottoming out
- Provides great rebound for tumbling

- Mildew, bacteria & UV treated
- Recommended for High School
- Fire retardant; ASTM E84 approved
- Order in solid or alternating panel colors; please specify
- "T" Items Ship by Truck

Description	No Velcro®		Velcro® On 2 Ends		Velcro® On 4 Sides	
	Item #	Each	Item #	Price	Item #	Each
4'x6'	X29045	\$156.99	X29049	\$170.99	X29053	\$198.99
4'x8'	X29046	209.99	X29050	223.99	X29054	250.99
5'x10'	T29047	330.99	T29051	350.99	T29055	383.99
6'x12'	T29048	476.99	T29052	482.99	T29056	539.99

Actual colors shown may vary.



2 3/8" Cross-Linked Polyethylene Foam Mat

Medium impact tumbling, gymnastics and more!

- 14 oz. laminate cover
- 2' folding panels
- Cushions impact without bottoming out
- Mildew, bacteria & UV treated
- Fire retardant; ASTM E84 approved
- Recommended for upper elementary
- Order in solid or alternating panel colors; please specify
- "T" Items Ship by Truck

CROSS-LINKED
FOAM

2-3/8"

SEMI-SOFT

ALL MATS
ARE FIRE RETARDANT &
BACTERIA RESISTANT

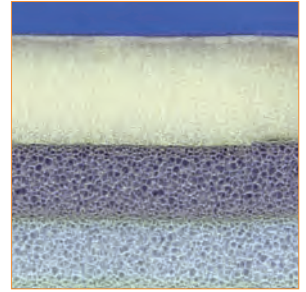

Note: All mats are considered custom and are non-returnable. Actual colors may vary from swatches.



Description	No Velcro®			Velcro® On 2 Ends			Velcro® On 4 Sides		
	Item #	Each	SALE	Item #	Each	SALE	Item #	Each	SALE
4'x6'	X29011	\$239.99	\$228.97	X29015	\$252.99	\$240.97	X29019	\$274.99	\$259.97
4'x8'	X29012	321.99	305.97	X29016	356.99	339.97	X29020	395.99	359.97
5'x10'	T29013	493.99	469.97	T29017	527.99	501.97	T29021	549.99	522.97
6'x12'	T29014	706.99	671.97	T29018	736.99	699.97	T29022	764.99	727.97

TruMAT™ 2" Bonded Urethane Foam Folding Mat

Excellent for low to medium impact gymnastics and tumbling.

- 14 oz. laminate cover
- 2' folding panels
- Mildew, bacteria & UV treated
- Fire retardant; ASTM E84 approved
- Recommended for elementary through junior high
- Order in solid or alternating panel colors; please specify
- "T" Items Ship by Truck

REBONDED
FOAM

2"

FIRM



IN A RUSH?

Mats are custom made for your size and color(s). Normal delivery is 1-2 weeks. If you need faster service call Customer Care and they will assist you with faster service at NO EXTRA CHARGE.

Note: All mats are considered custom and are non-returnable. Actual colors may vary from swatches.



Description	No Velcro®		Velcro® On 2 Ends		Velcro® On 4 Sides	
	Item #	Price	Item #	Price	Item #	Price
4'x6'	X29117	\$169.99 ea.	X29121	\$178.99 ea.	X29125	\$198.99 ea.
4'x8'	X29118	223.99 ea.	X29122	232.99 ea.	X29126	261.99 ea.
5'x10'	T29119	352.99 ea.	T29123	569.99 ea.	T29127	402.99 ea.
6'x12'	T29120	505.99 ea.	T29124	523.99 ea.	T29128	579.99 ea.

Actual colors shown may vary.



ENVIROSAFE MATS



EnviroSafe™ Foam

EnviroSafe™ Folding Mats

The new "Green" foam!

- Safer for the environment than other foams
- Made from 60% recycled and 40% virgin polyester fiber
- 18 oz. Phthalate free, fire retardant cover
- Patented foam technology
- Excellent cushion resistance
- Varying degrees of firmness
- 2' panels with Velcro® on 2 or 4 sides
- Royal blue ships in 1 week; allow 2-4 weeks delivery for other colors
- Order in solid or alternating panel colors; please specify
- Made in the USA
- "T" Items Ship by Truck



Velcro on 2 Ends	2" Soft IFD Foam	2" Medium-Firm	1-3/8" Extra-Firm	2-1/2" Extra-Firm/Soft Combo
4'X6'	X29382 \$227.99 ea.	X29386 \$196.99 ea.	X29390 \$193.99 ea.	X29394 \$236.99 ea.
4'X8'	X29383 288.99 ea.	X29387 250.99 ea.	X29391 240.99 ea.	X29395 297.99 ea.
5'X10	T29384 439.99 ea.	T29388 380.99 ea.	T29392 373.99 ea.	T29396 456.99 ea.
6'X12'	T29385 599.99 ea.	T29389 527.99 ea.	T29393 516.99 ea.	T29397 644.99 ea.

Velcro on 4 Sides	2" Soft IFD Foam	2" Medium-Firm	1-3/8" Extra-Firm	2-1/2" Extra-Firm/Soft Combo
4'X6'	X29398 \$248.99 ea.	X29402 \$217.99 ea.	X29406 \$214.99 ea.	X29410 \$258.99 ea.
4'X8'	X29399 313.99 ea.	X29403 276.99 ea.	X29407 264.99 ea.	X29411 324.99 ea.
5'X10	T29400 480.99 ea.	T29404 422.99 ea.	T29408 411.99 ea.	T29412 499.99 ea.
6'X12'	T29401 647.99 ea.	T29405 570.99 ea.	T29409 568.99 ea.	T29413 691.99 ea.



The EnviroSafe Foam Advantage

Feature	EnviroSafe	Urethane/Poly Foams
• 100% Toxin Free	YES	NO
• Zero VOC's or Off Gas	YES	NO
• Hypoallergenic	YES	NO
• Latex Free	YES	NO
• Fire Retardant Calif 117 T.B.	YES	NO
• Mold and Mildew Proof	YES	NO
• 100% Recyclable	YES	NO
• No Leachable Chemicals	YES	NO

Note: All mats are considered custom and are non-returnable. Actual colors may vary from swatches.

EnviroSafe™ Safety Landing Mats

For training, skill building and safe landing.

- Soft impact absorption with 50 IFD foam
- Mesh breather strips on long sides
- 18 oz fire retardant PVC coated covering
- 4" Velcro® end flaps

- 1" matching handles
- 4", 8" or 12" thickness
- 14 colors available- please specify
- Ships by Truck



Description	4'X8'	5'X10'	6'X12'
4" Thick: Non-Folding Flat Mats	T29422 \$419.99 ea.	T29423 \$517.99 ea.	T29424 \$822.99 ea.
8" Thick: Non-Folding Flat Mats	T29425 574.99 ea.	T29426 819.99 ea.	T29427 1,176.99 ea.
12" Thick: Non-Folding Flat Mats	T29428 755.99 ea.	T29429 1,118.99 ea.	T29430 1,543.99 ea.



FOLDING MATS



Foam Pit Cubes

Provides a combination of softness, durability and safe landing.

High quality cubes made from open cell polyurethane foam that has a 1.45" density and 45 ILD and is fire retardant. Each cube measures 6" x 6". Available in black, blue, charcoal, light gray, kelly green, orange, purple, red, and yellow. Ships by truck.

T45081 240 Pack (specify color) **\$305.99** pk.



UCS® Quick Ship 1-3/8" Folding Mats

Choice of solid royal or royal/yellow mats!

- 21 oz. knife coated vinyl cover with leather grain
- Stitched with high tenacity thread for durability
- 8 year guarantee
- "T" Items Ship by Truck



Velcro® On 2 Ends				
Size	Solid Royal		Royal/Yellow	
4'x6'	X29497	\$239.99 ea.	X29500	\$239.99 ea.
4'x8'	X29498	313.99 ea.	X29501	313.99 ea.
5'x10'	T29499	392.99 ea.	T29502	392.99 ea.

UCS® Quick Ship 2-3/8" Folding Mats

- 21 oz. knife coated vinyl cover with leather grain
- Stitched with high tenacity thread
- Ships from the manufacturer in 48 hours, arrival time varies by location.
- "T" Items Ship by Truck

Velcro® On 2 Ends				
Size	Solid Royal		Royal/Yellow	
4'x6'	X29509	\$271.99 ea.	X29512	\$271.99 ea.
4'x8'	X29510	366.99 ea.	X29513	366.99 ea.
5'x10'	T29511	467.99 ea.	T29514	467.99 ea.



UCS® Polyethylene Folding Mats

Choose your thickness, style of cover and color combination!

- 207 high tenacity thread, 21 oz. Embassy vinyl or Leather grain vinyl
- 1' panels and 2' folds for easy folding, lifting and storage
- Contains permanent anti-bacterial inhibitor to prevent spread of germs
- Velcro® on 2 ends or all 4 sides- your choice
- "T" Items Ship by Truck

UCS® 125 Series 1-3/8" Embassy Vinyl

Choose any solid or color combo from below

Size	Velcro® on 2 Ends		Velcro® on 4 Ends	
4'x6' *	X29230	\$271.99 ea.	X29234	\$313.99 ea.
4'x8'	X29231	408.99 ea.	X29235	461.99 ea.
5'x12'	T29232	601.99 ea.	T29236	664.99 ea.
6'x12'	T29233	677.99 ea.	T29237	779.99 ea.

Royal Blue	Tan
------------	-----

UCS® 225 Series 2-3/8" Embassy Vinyl

Choose any solid or color combo from above

Size	Velcro® on 2 Ends		Velcro® on 4 Ends	
4'x6'	X29246	\$309.99 ea.	X29250	\$358.99 ea.
4'x8'	X29247	479.99 ea.	T29251	471.99 ea.
5'x12'	T29248	758.99 ea.	T29252	779.99 ea.
6'x12'	T29249	798.99 ea.	T29253	849.99 ea.

UCS® 140 Series 1-3/8" Leather Grain

Choose any solid or color combo from below

Size	Velcro® on 2 Ends		Velcro® on 4 Ends	
4'x6'	X29238	\$240.99 ea.	X29242	\$285.99 ea.
4'x8'	X29239	313.99 ea.	X29243	363.99 ea.
5'x10'	T29240	392.99 ea.	T29244	432.99 ea.
6'x12'	T29241	523.99 ea.	T29245	574.99 ea.

Red	Yellow	Purple	Royal Blue	Black	Orange	Maroon
-----	--------	--------	------------	-------	--------	--------

UCS® 240 Series 2-3/8" Leather Grain

Choose any solid or color combo from above

Size	Velcro® on 2 Ends		Velcro® on 4 Ends	
4'x6'	X29254	\$271.99 ea.	X29258	\$311.99 ea.
4'x8'	X29255	366.99 ea.	X29259	411.99 ea.
5'x12'	T29256	467.99 ea.	T29260	511.99 ea.
6'x12'	T29257	613.99 ea.	T29261	661.99 ea.

EXERCISE MATS



Padded Exercise Mat

Ideal for yoga, stretching or rehab work.

Superb cushioning with closed cell compressed foam provides a non-slip grip. Lightweight and easy to clean and roll up. Includes carry strap. Measures 72" L x 22" W x 5/8" thick.

- X29459 \$21.99 ea.
- X66816 10 Pack 209.99 pk.



TROY Trifold Exercise Mat

Compact fold takes up less space and makes it easy to store.

The Trifold's 1.5" thick padding provides comfortable support while its durable vinyl covering is easy to clean. Built-in handles make transport easy. Measures: 72" L x 24" W x 1.5" H. Weights: 8 lbs.

- X54350 Single Mat \$43.99 ea.
- X66817 6 Pack 229.99 pk.



2" Folding Mats

Excellent for stretching and core workouts.

Easy to clean with a non-absorbent cover over high density foam. Heavy duty stitched seams and handle for transport. Folds for storage.

- X29451 4'L x 2'W \$49.99 ea.
- X29452 6'L x 2'W 74.99 ea.
- 29454 6'L x 4'W 124.99 ea.



Everlast Folding Exercise Mat

Ideal for core workouts!

Non-absorbent shell with sewn in handle for easy transport. 1 5/8" foam core for support and comfort. Folds for storage. Black. Measures 6'L x 2'W.

- X29557 \$59.99 ea.
- X29558 6 Pack 339.99 pk.



Smart Mat™

Core and stretching exercises printed on both sides!

Durable non-slip nitrile rubber mat with easy to follow exercises and stretches on both sides. Includes grommets for hanging. 6'L x 2'W x 16mm thick. Blue.

- 29443 Blue Smart Mat \$54.99 ea.
- 29444 10 Mat Pack with Rack 599.00 pk.
- 29460 Wall Rack only 116.00 ea.



Vinyl Folding Exercise Mat

An excellent economy folding mat.

A basic vinyl mat with three folds and a .625" thick foam center. Measures 46" x 20".

- X29010 \$11.99 ea.

TRAINING & LANDING MATS

UCS® 221 Series Fat Pads

Encourages the development of motor skills at all age levels safely!

Made with an extra high resilient polyethylene foam, these mats will endure years of vigorous use. Covered with 21 oz. vinyl knife coated nylon and designed with vinyl extruded nylon breather material to release the right amount of mat depression. Each mat has 8 carry handles. Flat Fat Pads have a one piece top with no seams and the breather mesh feature is on top. Folding Fat Pads also have a one piece top to form a crackle surface with the sides featuring the vinyl breather mesh fabric. Available in 8" or 12" thicknesses in the following colors: maroon, red, orange, yellow, green, blue, purple and black. Please specify color. 5 year guarantee. Ships by Truck.

Description	Fat Pads		Folding Fat Pads	
4'x8'x8"	T29304	\$470.99 ea.		
5'x10'x8"	T29305	625.99 ea.	T29309	\$699.99 ea.
6'x12'x8"	T29306	867.99 ea.	T29310	922.99 ea.
5'x10'x12"	T29307	731.99 ea.	T29311	891.99 ea.
6'x12'x12"	T29308	1,126.99 ea.	T29312	1,207.99 ea.



UCS® 220 Series Deluxe Training Pads

A great all around mat for climbing walls, tumbling and other motor skill activities!

Offers more cushion than the Competition Mat, these mats are designed to withstand rigorous use of training programs. Manufactured with a top layer of polyurethane foam and bottom 1 3/4" polyethylene, to provide great cushioning without bottoming out. Covered in thick 21 oz. vinyl on top and bottom with heavy vinyl extruded nylon breather material on the sides. Hinged in two areas to allow a quarter or half of the mat to fold to create a great spotting platform. Each mat comes with 12 handles that will not pull out. Envelope design and Velcro® closing system protect zippers. Available in 8" or 12" thicknesses in the following colors: maroon, red, orange, yellow, green, blue, purple and black. Please specify color. 15 year guarantee. Ships by Truck.



Note: All mats are considered custom made and are non-returnable. Actual colors may vary from swatches.



Description	5'x10'		6'x12'	
8" Thick	T29326	\$1,301.99 ea.	T29325	\$1,610.99 ea.
12" Thick	T29328	1,573.99 ea.	T29327	1,992.99 ea.



FLOOR COVERING

Mobile Storage Rack

Saves time in set up and removal!

Unit includes 2 hand cranks and 3 fabric clips per roller for secure and easy winding. All steel construction supports up to 2800 lbs. of fabric, moves smoothly on 8" diameter wheels. Fits rolls up to 10' wide. Includes instructions for safe and fast operation. Racks measure 12'6"L x 34"W x 67"H with 2.5" diameter rollers and 14 gauge steel construction. Ships by Truck.



- T43421 6 Roll Storage Rack \$2,554.99 ea.
- T43422 8 Roll Storage Rack 2,846.99 ea.
- T43423 10 Roll Storage Rack 3,171.99 ea.
- X43426 Storage Rack Cover..... 259.99 ea.

Brush Assembly

Clean your covering as you wind!

Durable nylon bristles sweeps floor covering clean and gets it ready for your next event! Easy to attach, secure steel housing.

X43425 \$790.99 ea.



GymGuard™ Floor Covering

Protect your gym floors from heavy foot traffic, stains, scuffs and more!

Made with ultra durable flame retardant 3 ply fabrics of reinforced polyester yarns that are PVC coated

on both sides for dual use. Fabrics are anti-bacterial, anti-fungal, rot and mildew resistant. Seams are engineered to be tear resistant and lay flat to prevent tripping. Available in 100'L x 10'W lengths in a variety of colors and thicknesses. Ships by truck.

- T43418 18 oz. 100'L x 10'W Roll -Specify Color \$761.99 ea.
- T43419 22 oz. 100'L x 10'W Roll -Specify Color 930.99 ea.
- T43420 27 oz. 100'L x 10'W Roll -Specify Color 1,117.99 ea.



Electric Power Winder

Save time winding your floor coverings!

115v motor, 32 RPM spindle speed with spur and worm gear winder.

43424.....\$906.99 ea.



SPECIALTY PADDING



6 PADS WITH GRAPHICS ON ALL PADS

Q.C. Net Works Custom Wall Pads



Choose preset packages below, or call for custom length runs. Make the gym pop with custom wall pads printed with personalized team logos on resilient 14 oz. vinyl. Graphics are digitally printed and a sample is provided for customer approval. Vinyl is phthalate free and mildew/rot resistant. Have your design printed on the center panels or all panels. Two package sizes offered. Call for quotes on custom heights (up to 8' tall) and extended run lengths.

- 6'H x 12'L Custom Pad Package**
- C29576 6 Pads w/ Graphics on 4 Center Pads..... \$849.99 pk.
- C29577 6 Pads w/ Graphics on All Pads..... 1,165.99 pk.
- 6'H x 16'L Custom Pad Package**
- C29578 8 Pads w/ Graphics on 6 Center Pads..... \$1,074.99 pk.
- C29579 8 Pads w/ Graphics on All Pads..... 1,449.99 pk.

Actual colors shown may vary.

Black	Navy	Forest	Light Gold	Dark Royal	Red	Marine	Sky	Purple	Bright Purple	Royal	Maroon	Light Maroon	Gray
Camel	Flair Red	Orange	Beige	Rich Red	Dark Maroon	Yellow	Bright Navy	Bright Forest	Kelly	Bright Kelly	Champion	Galaxy	White

Q.C. Net Works Impact Wall Pads

Meets ASTM guidelines for impact protection.

Pads are NFPA 701 rated for fire resistance and meet ASTM 2440 guidelines. They are made from 6 lb. density rebond and are OSB wood backed. Bonded foam has a density of 5.5 – 6.5 lbs./ft. squared. Durable 14 oz. vinyl is phthalate free and mildew/rot resistant. Measures 2'W x 6'H x 2" thick. Call for a freight quote – normal shipping policy does not apply.

- C29580 \$82.99 ea.

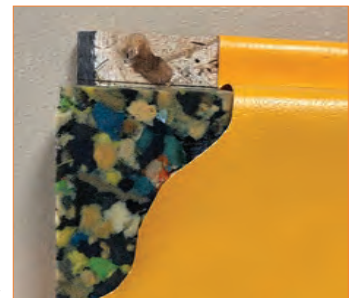

Large Corner Pads

Covers corners & partially exposed beams.

Mats are attached to a plywood backing that can be mounted. Made from 2" bonded foam with 14 oz. laminate cover, these mats cover 6" on each side of corner and are 6' high. Available in colors shown below.

- X29206 6" x 6" x 6'L..... \$127.99 ea.



Universal Pole Padding

Ideal for volleyball game standards or other uprights.

The 6' tall pad accommodates poles to 8" diameters with Velcro® straps to hold pad in place. Durable 14 oz. laminate cover with a 1-1/2" polyurethane foam. Available in colors shown below.

- X29218 \$122.99 ea.



I-Beam Padding

Covers the front face and sides of I-Beams.

Simply measure across the flat face of your beam and choose a color. Ordering is that easy! These 6' long pads are made with 2" polyurethane foam with a 14 oz. laminate cover. Each pad is plywood backed with Velcro® strips for attaching to your beam. Side lip of padding reaches around 1.5" deep on the side of the beam. Available in 4 standard sizes. Available in colors shown below.

- X29205 6"W x 6'H- specify color..... \$131.99 SALE \$122.97 ea.
- X29292 8"W x 6'H- specify color..... 160.99 SALE 149.97 ea.
- X29291 10"W x 6'H- specify color..... 188.99 SALE 174.97 ea.
- X29290 12"W x 6'H- specify color..... 205.99 SALE 194.97 ea.



Square or Round Pole Pads

Fits square or round poles, beams or columns.

To order, just measure the width of a flat beam or the diameter across of a round pole and choose a color. Pads are made from 2" polyethylene foam with an indoor/outdoor 14 oz. laminate cover. Velcro® flap closure along the back, stays in place, does not pucker or wrinkle. Pads come in standard height of 6' high. Available in colors shown below.

- X29295 4"W x 6'H- specify color..... \$199.99 ea.
- X29296 6"W x 6'H- specify color..... 228.99 ea.
- X29297 8"W x 6'H- specify color..... 309.99 ea.



Camel	Red	Royal	Navy	Kelly	Grey	Forest	Black	Light Gold	Orange	White	Light Blue	Maroon	Purple
-------	-----	-------	------	-------	------	--------	-------	------------	--------	-------	------------	--------	--------

- 1 PREPARE YOUR LOGO
- 2 PICK YOUR MAT SIZE
- 3 PICK YOUR MAT COLOR

CALL US
FOR ORDERING ASSISTANCE
1-800-233-5484

Note: All mats are considered custom made and are non-returnable. Actual colors may vary from swatches.



Professional Installation Available
 We offer installation in the Chicagoland area.
 1-800-233-5484, in Illinois 1-708-396-2555

Safety Wall Padding

Create a safe playing area!

- 2" bonded foam for superior protection
- 14 oz. heavy duty laminate cover
- 7/8" OSB backing that will not warp or twist
- 2' wide panels in 4 lengths
- Easy to order- just call our Customer Care for assistance
- Custom cut outs available at an additional charge



Wall Padding Panels with Mounting Lip

Screw directly to wall through the 1" mounting lip!

Be sure to mention if you need cut outs around light switches, fire alarms or other wall mounted items. Ships by truck and carries an extra \$50.00 charge per every 3 panels ordered. Specify color listed below. Call for freight quote-our regular shipping policy does not apply to this product.

- C29103 2'W x 4'H- specify color \$54.99 ea.
- C29104 2'W x 5'H- specify color 69.99 ea.
- C29105 2'W x 6'H- specify color 80.99 ea.
- C29106 2'W x 7'H- specify color 92.99 ea.

Note: All mats are considered custom made and are non-returnable. Actual colors may vary from swatches.

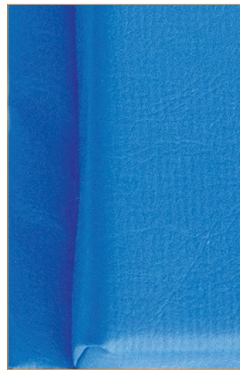

1" mounting lip



STAGE PADDING



Stage Mats

Semi-permanent so you can access spaces underneath!

Easy to order with 3 simple measurements: the return the height and the length (return x height x length). Mats are made from 2" olyethylene foam with heavy 16 oz. 80/20 coated vinyl cover (80% on the finished side). Each mat section comes with Velcro® sewn to the underneath and the adhesive matching strip to place on the stage for installation. Please specify colors listed below. Call for freight quote-our regular shipping policy does not apply to this product.



- C29212 \$12.99 sq. ft.

Actual colors shown may vary.

Mat Wall Channel

Aluminum channels with hook sided Velcro®.

Use for optional semi-permanent padding situations or ideal for padding storage. Sold individually in 6' long sections, easy to cut down to customize to size needed. Please call for assistance when ordering mats to be used with these channels.



- 29288 6'Long..... \$39.99 ea.

Removable Velcro® Backed Wall Mats

Mats attach and detach with velcro!

The 2'W x 6'H mats are made with 2" rebonded foam - laminated 14 oz. cover and does not have any wood backing. Velcro® loop is attached to the backside of the mat for connecting. Purchase Mat Wall Channels with Velcro® hook separately. Specify color listed below.

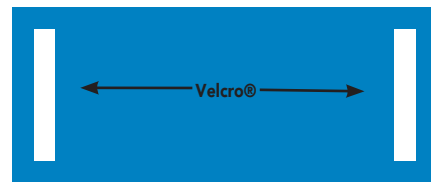

- X29287 2'W x 6'H- specify color \$127.99 ea.

Camel	Red	Royal	Navy	Kelly	Grey	Forest	Black	Light Gold	Orange	White	Light Blue	Maroon	Purple
-------	-----	-------	------	-------	------	--------	-------	------------	--------	-------	------------	--------	--------

TERMS & CONDITIONS

Sales Tax: Customers will be charged applicable taxes, unless proof of tax-exempt status is furnished to Palos Sports. Tax-exempt customers should attach/include a copy of their tax exemption certificate with their order.

All Schools Get Instant Credit with Valid Purchase Order: Call our customer care team for details.

International orders welcome: Please call, fax or email for shipping and payment information.

Prices: We reserve the right to change prices due to unforeseen increases or decreases in manufacturer's prices. Catalog prices are current as of January 1, and are subject to change without notification.

Return of Merchandise Guarantee: Call our Customer Care Center to obtain your Return of Merchandise Authorization (RMA) Number. Returns received without an RMA# will not be accepted and no credit shall be issued.

Software:

Software downloads are considered opened at the time of purchase and may only be replaced with identical software/media within 30 days if the original purchased software is defective.

Special Shipping Options: Options such as lift gate, inside delivery and residential delivery will incur additional shipping charges. Select items that ship by truck may qualify for free shipping, which includes tailgate delivery only.

Direct-Ship: Merchandise shipped directly from the manufacturer to the customer.

Alaska, Hawaii and Canada: Shipping to these locations require a freight quote. Please contact our Customer Care Team.

Damaged on Arrival: Inspect all shipments before accepting. If a package is visibly damaged, refuse to accept until delivery receipt is marked "Received in Damaged Condition." Immediately contact the Customer Care Team at Palos Sports.

Claims: Claims for damage should be immediately filed with the transportation company. If concealed damage is discovered upon unpacking, contact the Customer Care Center immediately.

Price Matching: Palos Sports is committed to delivering the best products at the best value. All products are competitively priced and our price matching policy guarantees we will match a price in a competitor's catalog, from the same published year, for identical items/quantities.

Shortages: Shortage, lost, or missing merchandise is our responsibility only after the following precautionary measures have been followed by the customer.

(1.) Do not sign delivery ticket unless all packages specified on Bill of Lading are accounted for. If receipt has been signed for total delivery, carriers assume no responsibility. (2.) Check your master Packing Slip. Direct-Ship Items or those on back-order will be delivered separately. (3.) Check all packages marked miscellaneous merchandise carefully.

(4.) If summer delivery has been made, check your warehouse carefully.

Restocking Fee: A restocking fee of 10-20% may be charged for returned goods. The fee(s) will be assessed by the company receiving the merchandise (Palos Sports or a vendor).

▲ CHOKING HAZARD (1) – SMALL PARTS

Not for children under 3 yrs.

▲ CHOKING HAZARD (2) – IS A SMALL BALL

Not for children under 3 yrs.

▲ CHOKING HAZARD (3) – CONTAINS A SMALL BALL

Not for children under 3 yrs.

▲ CHOKING HAZARD (4) – IS A MARBLE

Not for children under 3 yrs.

▲ CHOKING HAZARD (5) – CONTAINS A MARBLE

Not for children under 3 yrs.

▲ CHOKING HAZARD (6) – BALLOON

Children under 8 yrs. can choke or suffocate on uninflated or broken balloons. Adult supervision required.

Keep uninflated balloons from children.

Discard broken balloons at once.

Palos Sports makes every effort to depict accurate product descriptions and prices. However, due to changing manufacturing conditions, product color, specifications and prices are subject to change without notice. We reserve the right to correct typographical errors. Due to press variation, actual product color may be slightly different than product colors shown in this catalog.

Shipping & Handling Information for the Continental U.S.

Non-Prefix 00000 Items

Order Value	Applied Charges
Under \$125	\$12.95
\$125+	16% of sales
X Items X00000 (Hvy-O/S)	16% of sales, minimum \$12.95
T Items T00000 (Truck)	16% of sales plus \$50
C Items C00000 (Hvy-Freight)	Please call to order these items

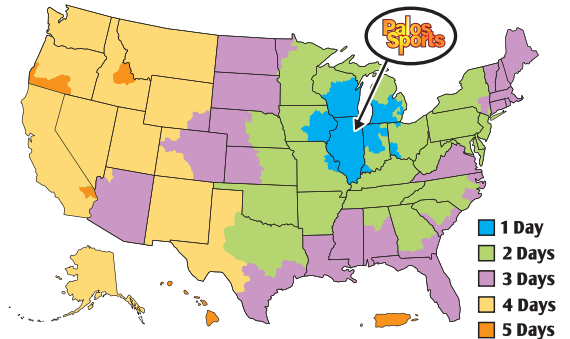

Approximate ship times

Use any of these four convenient ways to order

Online PalosSports.com

Receive FREE SHIPPING on your online order over \$125! See back cover for code. Offer expires 12-31-2020

Phone 800-233-5484

Fax 877-800-5973

Mail 11711 S. Austin Avenue • Alsip, IL 60803

Use any of these four convenient ways to order

Online PalosSports.com

Receive FREE SHIPPING on your online order over \$125! See back cover for code. Offer expires 12-31-2020

Phone 800-233-5484

Fax 877-800-5973

Mail 11711 S. Austin Avenue • Alsip, IL 60803

SOURCE CODE

Please find the Source Code on the back of this catalog and enter it in the Source Code box above. This will ensure that you receive any special offers and promotions!

1. Ship to:

Account # _____ PO# _____

Name _____ Title _____

School Name _____

Street Address _____

City _____ State _____ Zip _____

Phone # _____ Fax # _____

E-Mail Address _____

2. Bill to:

Same as above

Account # _____ PO# _____

Name _____ Title _____

School Name _____

Street Address _____

City _____ State _____ Zip _____

Phone # _____ Fax # _____

E-Mail Address _____

3. Your Order:

Item #	Quantity	Description	Color	Price	Total

Order Authorized By:





Print Name _____

Title or Department _____

4. Method of Payment

Check Bill My Account Money Order

Credit Card Palos Sports Gift Card

Credit Card #/Gift Card # _____

Signature of Cardholder _____ Expiration Date _____

Name as it appears on card _____

Shipping & Handling Information for the Continental U.S.	
Non-Prefix 00000 Items	
Order Value	Applied Charges
Under \$125	\$12.95
\$125+	16% of sales
X Items X00000 (Hvy-O/S)	16% of sales, minimum \$12.95
T Items T00000 (Truck)	16% of sales plus \$50
C Items C00000 (Hvy-Freight)	Please call to order these items

Check this box if you would like to receive our enewsletter and special offers.

E-Mail Address _____

Thank you for your order!

See Terms and Conditions on previous page.
Visit our website to download additional order forms.

Merchandise Total	_____
Shipping & Handling <small>(see previous page)</small>	_____
Sales Tax <small>(Attach tax-exempt certificate if applicable)</small>	_____
TOTAL	_____

A

20 Sided Dice 164, 279
 4FUN 6 in 1, 162
 9 Square in the Air ...45, 143
 A to Z Poly Spots 123
 Ab Board..... 252
 Ab Mat 253
 Ab Straps 252
 Action Domes 165
 Activate 2 Educate..... 334
 Active Furniture..... 329
 Activity Trackers..... 282
 Adaptive PE Equipment.....
 110, 129-133
 Adjustable Scorekeeper . 318
 AEDs 297
 After School Kits 15
 Agility Ladders.....262-263
 Agility Sticks..... 63, 269
 Agility Training 261-267
 Air Gauge 311
 Air Horn 315
 Air Pumps..... 311
 Air Zone Curling Game... 151
 Alien Invasion 136
 Alien Spaceship Battle . 8, 138
 Alien Target Set 136
 Alphabet Bean Bags 160
 Angleball Set 152
 Animal Bean Bag Sets ... 160
 Ankle & Wrist Weights ... 236
 Aquajogger Belts..... 291
 Archery Equipment . 176-178
 Arrows, Archery..... 176
 Assessment 284-287
 Assisted Cannon Launcher....
 133
 Assisted Running Handles....
 132
 Assisted Running Rope . 132
 Athletic Playballs..... 114
 Athletic Tape 292
 Audio Equipment ... 312-314
 Awards 320-323

B

Back Hyperextension Machine
 246
 Badminton Equipment.....
 218-221

Baggio 144, 162
 Balance & Movement
 199-204
 Balance Beams
 200, 201, 259, 342
 Balance Blox Kits..... 200
 Balance Boards & Discs
 199, 259
 Balance Domes
 133, 258, 259
 Balance Master 199
 Balance Pods..... 259
 Balance Stones 200
 Ball & Stick Pack . 9, 179, 280
 Ball Carts 306-309
 Ball Doctor 311
 Ball Hopper, Tennis..... 225
 Ball Hops 180
 Ball Kits 114
 Ball Launchers..... 149
 Ball Slam 145
 Ball Storage & Carts . 307-309
 Ball Transfer Game 155
 Balloon Badminton. 133, 216
 Balloon Ball 115
 Balloon Pump, 115
 Balloons 115
 Bandages 294
 Baseball & Golf Bean Bag
 Game 163
 Baseball Equipment... 69-77
 Baseball/Softball Bases
 76, 77
 Baseball/Softball Bats..... 72
 Baseball/Softball Gloves.....
 74, 75
 Baseballs & Softballs.....
 70, 71, 264
 Basket Cart 310
 Basketball Backboard Padding
 29
 Basketball Backboards . 28-29
 Basketball Circle Starter Hoop
 35
 Basketball Equipment . 24-37
 Basketball Goals 30-31
 Basketball Nets 31
 Basketball Systems- Outdoor
 32
 Basketball Systems- Portable..

..... 34, 35
 Basketball Training Aids... 36
 Basketballs.....10, 14, 24-27
 Batons, Track 81
 Batteries 283, 314
 Batting Helmets 69, 97
 Batting Tees 77
 Battle Ropes..... 226
 Beach Balls.....43, 115
 Beach Volleyballs 41
 Beamo 172
 Bean Bag Bocce Packs
 147, 161
 Bean Bag Bucketz 163
 Bean Bag Toss . 144, 161, 162
 Bean Bags 9, 160-161
 Beeper Ball..... 130
 Bell Balls..... 129
 Belly Bumpers..... 158
 Benches 327
 Big Ball Inflator 117, 311
 Big Foot Walkers..... 200
 BirdieBall 208
 Bleacher Barriers..... 92
 Bleachers 326
 Blindfolds..... 156
 Block & Pole Pack 269
 Bluetooth Speakers.. 313-314
 Board Games.....19, 169
 Bocce Ball Sets. . 20, 146, 163
 Body Bars 241
 Body Fat Analyzers . 286, 287
 Body Puzzles 330
 Bodyweight Training.....
 248-250
 Boomboxes 313
 Border Patrol 92
 Bosu Training..... 258
 Bounce Free Balls
 72, 105, 209
 Boundary Lines 46
 Bounder Ball 5, 141
 Bowling Balls..... 190
 Bowling Bell Bands. 130, 193
 Bowling Equipment
 18, 190, 192-193
 Bowling Lane..... 193
 Bowling Ramp..... 130
 BowNet Goals 75
 Bows, Archery..... 176

Bowstrings, Archery..... 78
 Boxing & Martial Arts 254
 BRAINball... 7, 134, 332, 333
 Broomball Sets 87
 Bucket Ball Transfer 154
 Buckets9, 163, 179, 310
 Bump Balls..... 110, 131
 Bumper Plates..... 243
 Bungee Jumper ... 180, 202

C

Cage Balls 116
 Calf Stretcher 270
 Camp Volleyballs 41
 Cando Tubing & Bands.....
 192, 227-230
 Cannon Cubes.....3, 137
 Cannon Launcher Set.....
 3, 137, 153
 Canopies 81
 Card Games..... 169
 Carpet Mats 344
 Catch & Balance Se 155
 Catch Gloves ... 73, 131, 149
 Catch Pads 149
 Catch-A-Ball 148, 204
 Catchers Equipment..... 69
 Chairs 328
 Challenge Mat..... 278
 Chenille Pins 323
 Chinese Jump Ropes 181
 Chinning Bars 250
 Chipping Nets 209
 Circuit Trainer Timers 277
 Circuit Training & Stations ...
 22, 276, 278, 279, 281

Class Packs.....
 11-23, 144, 146, 148
 Climbing Nets 338, 339
 Climbing Ropes..... 337
 Climbing Walls & Holds.....
 340, 341
 Clipboards 301
 Coaches Aids 300-303
 Cold Packs 295
 Compasses..... 157
 Cone Carts 125
 Cone Crossbars79, 126
 Cone Sleeves 128
 Cone Toppers..... 128
 Cones21, 125-128

Cones & Noodle Kit..... 127
 Connect-A-Scooter..... 194
 Coolerball..... 152
 Co-Op-A-Mat 154
 Core Stability..... 253, 259
 Core Training..... 252-253
 Core Wheels..... 253
 Corner Flag Set 63
 Count Up/Down Clock
 277, 315
 Court Chairs..... 328
 Court Clean System 37
 CPR Equipment..... 297
 Crawling Tunnel 204
 Create-A-Beam..... 201
 Cricket..... 150
 Croquet Sets 150
 Cross Timer 277
 Crossbars 83
 Crossnet 152
 Crossnet Volleyball 46
 Crunch Strips..... 285
 Curling 151
 Curl-Up Assessment Mat
 274, 285
 Curved Balance Beam ... 201

D

Dance & Music..... 179
 Dance Ribbons 179
 Dancing Scarves 179
 Dart Ball 153
 Deck Rings..... 145
 Diabolo..... 205
 Dip Station..... 252
 Disc Catchers 175
 Disc Dive..... 173
 Disc Golf..... 173-175
 Disc Slam 18, 145, 172
 Disc Targets & Games ... 175
 Discs 18, 80, 170-174
 Discus & Shot Puts 80
 Disinfectant Wipes 247
 D-Man..... 36
 Dodge Disc..... 4, 138, 172
 Dodgeballs.....
 12, 13, 99, 101, 103-104
 DodgeBee 172
 DodgeDisc 138, 139, 172
 Dome Cones 127
 Dot Drill Mat 263

- Double Dutch Ropes 181
 Dough Balls 108
 Dribble Aid 36, 130
 Dribble Stick 36
 Dry Erase Boards 336
 Dry Line Field Markers . . . 303
 Duffel Bags 2, 304
 Dumbbells 238-240
- E**
 Easton Incrediballs 70
 Easy Grip Ball Sets 54, 110
 Easy Play Game Standards . 48
 Eclipse Ball 217
 Edushape Rainbow Soft Ball
 109
 Egg & Spoon Set 139, 204
 Egg Protector Game 156
 Electronic Whistles 300
 EnviroSafe Mats 349
 Equipment Bags & Carts
 304-310
 Equipment Carriers 304-310
 Escapades 157
 Evasion Belt 266
 Exam Gloves 295
 Exercise Balls 260
 Exercise Cards 335
 Exercise Dice 9, 164, 278, 279
 Exercise Mats 274-275, 351
 Exer-Dice 164, 279
 Eye Guards 225
 EZ-UP Shelters 81
- F**
 Fast Food Foolery 9
 Fat Pads 352
 Felt Pucks 96
 FiddleSTX Lacrosse 85
 Field Day Kit 15, 158
 Field Hockey Equipment . . . 87
 Field Markers & Paint 303
 Finish Line Tape 82
 First Aid Equipment 292-299
 First Aid Kits 296
 Fish Footballs 107
 FitDeck Exercise Cards . . . 278
 Fitness Balls 260
 Fitness Dice 279
- Fitness Equipment 226-288
 Fitness Machines 246
 Fitness Stations 276-279
 Fitness Steps & Carts 256
 Fitness Tubing 227-230
 Flag Football Equipment
 17, 55-57
 Flag-A-Tag 17, 57
 Flat Benches 246
 Flat Hoops 188, 262
 Fleece Balls 108, 109, 131, 161
 Fleece Bell Ball 109
 Flex Flyer 171
 Flexibility Testers 284-286
 Flip-A-Score 32, 318
 FlipZ 2, 138
 Floor Covering 352
 Floor Hockey Equipment
 87-97
 Floor Hockey Goals 94-95
 Floor Hockey Sticks 88-93
 Floor Markers 121
 Floor Sleeves 51
 Floor Surfer 198
 Floor Tape 121
 Floorball 87-97
 Flooring 255
 Floormarx Floor Markers . . . 37
 Fluff Balls 108
 Flying Saucer Face Off
 8, 138
- G**
 Games & Activities 129-169
 Gamma Tennis Balls 224
 Garden Heroes Bean Bags
 160, 330
 Gatorade Coolers & Carts . . . 298
 Get Knotted 168
 Giant Beach Ball 115
 Giant Checkers & Chess . . . 168
 Giant Dice 168
 Giant Dominoes 168
 Giant Footballs 117
 Giant Games 168
 Giant Toothbrush 157
 Giant Top 133
 Giant Tower 168
 Glute/Ham Stations 246
 Goal Ball 35
 Goal Pylons 55
 Goalie Equipment, Hockey
 82
- Foam Rocket 97
 Foam Rollers & Racks 271
 Foam Soccer Balls 62, 100
 Foam Tennis Balls 224
 Foam Tumbling Shapes
 342, 343
 Foam Wedges 342, 343
 Folding Chairs 328
 Folding Goals 65
 Folding Mats 275,
 344-352
 Folding Wagon 306
 Foosball Table 168
 Foot Golf 152
 Football Equipment 52-57
 Footballs 10, 52-54, 264
 Four Square Ball Set
 111, 113
 Fox 40 Whistles 300
 Frisbees 170, 171
 Fruits & Veggie Bean Bags
 330
 Fruits & Veggie Games
 330, 331
 Fruits & Veggies Spot Markers
 123
 Fun Gripper Ball Set 114
 Fun Gripper Disc 171
 Funny Face Ball Set 107
 Futsal Balls 62
- H**
 Half Cones 127
 Half Mile Hailer 314
 Hand Pumps 311
 Hand Weights 238-240
 Handball Equipment
 140, 141
 Handballs 107, 140
 Handweights 238-240
 Hang-Emz 128
 Health-O-Meter Scales
 287
 Heart Rate Monitors 282
 Heart Zones PE System 282
 Heavy Bags, Gloves 254
 Heavyweight Traffic Cones
 126
 Hi Jump Trainer 231
 Hi Jump Trainer 267
 Hidden Spots 122, 139
 High Jump Standards 83
 Hi-Lo Scoop Game 149
- Hockey Carts 96
 Hockey Equipment
 88-90, 94, 96
 Hockey Pucks/Balls 96
 Hoop Cart 189
 Hoop Holders 189
 Hoop Jumpers 181
 HoopKlipperz 189
 Hoops 188-189
 Hop Balls 202
 Hopscotch Mats 164
 Horseshoe Sets 144
 Hot Spots 21, 124, 125,
 182, 188, 260, 272, 276
 HumanHoops 158
 Hurdles 78-79, 268-269
 HybriMAT Target, Archery
 177
 Hydration Stations 298, 299
- I**
 I-Beam Padding 353
 Ice Bags 295
 Ice Cream Scoop Relay
 8, 139, 204
 Incline Mats 343
 Indo Board Balance Trainer
 199
 Inflators & Needles 311
 In-School Bowling Set 192
 Insta-Bench 327
 InstaPulse Monitors 286
- J**
 Jacks & Ball Set 169
 Javelins, Training 82
 Joola Table Tennis Tables
 210-211
 Juggling Equipment 205
 Jumbo Spots 122
 Jumbo Stacks 167
 Jumbo Volleyball 43
 Jump & Reach Board 285
 Jump Bands 181
 Jump Rope & Hoop Cart
 185, 189
 Jump Rope Pad 132
 Jump Ropes 180-185
 Jump Trainers 267
- K**
 Kan Jam Game 18, 145, 172
 Karaoke Machine 312

Katch-A-Basket	148	Medals, Award	320-321	Obstacle Course Packs	Playboards	301	218-219		
Kettlebells & Racks	236, 237	Medicine Balls & Racks	232-234	Octa-Rings	Playground Balls	111-113, 324	Racquets, Tennis	222	
Kickballs	112	Mega Bands	229, 245	OgoSport Disks	Playground Equipment	324, 325	Railyard Fitness	288	
Kicker Helper	129	Megaphones	82, 302	Olympic Weight Equipment	Playout Fitness Game	278	Rainbow Mesh Tunnel	133	
Kicking Tees	55	MegaTimer	277, 315	Omnikin Balls	Plyometric Training Platforms	261	RampShot	143	
Kidsfit Desks	329	Memory Maze	157	Order Form	356	Pocket Cubes	164, 279	Reaction Ball	262
Kinesiology Tape	293	Mesh Bags	304	Over-N-Under Hurdle	79, 165	Pogo Sticks	202	Rebounders	235, 257
Kits	75, 125, 127, 155, 156, 178, 180, 184, 186,	Mesh Vests	118-120	Oversized Playballs	115-117	Pole Padding	48, 353	Recess Kits	324
Kneepads	44	Mini & Maxi Nets	49, 221, 224	Oversized Soccer Balls	61, 115-116	Poly Cones	126	Recovery	271
Knock Down Targets	8, 114, 138	Mini Markers	126	Oversized Volleyballs	43, 115-116	Poly Numbered Bases	76, 123-124	Referee Pinnies	120
L		Miniature Golf Equipment	206	Overspeed Trainers	231, 266-267	Poly Spots	122, 123	Referee Platforms	51
Lacrosse Balls	86	Modified Pull-Up Bar	284	Over-The-Top Trainers	231, 266-267	Poof Foam Football	54	Referee Shirts	301
Lacrosse Equipment	84-86	Mother May I Thumball	335	P		Pop Up Soccer Goals	64-65	Resistance Bands	227-231
Lacrosse Goals	86	Motorola Two Way Radios	314	P.A. Systems	312	Portable P.A. Systems	302, 312, 314	Resistance Training	227-231
Ladder Ball Golf Sets	148	Mouthguards	55, 97	Paddle Games	214-217	Portable Scoreboards	318	Reversible Scrimmage Vests	37, 118
Landing & Training Mats	352	Movin Hoop	35	PaddleZlam	217	Port-A-Net	49, 221	Rhythm & Dance	179
Landmine Unit	244	Multi-Domes	165, 189	Palm Catchers	131	Possession Indicator	32	Rhythmic Play	179
Lane Timer	83, 315	Multi-Lane Timer	315	Palyground Balls	110-113	Post Pads	32	Ribbons, Award	323
Lanyards	301	Multi-Press Rack	246	Par Putt Golf	207	Posters	270, 336	Ring Toss Sets	145
Lebert Equalizer	248	Multi-Ring Basketball Stand	35	Parachutes & Accessories	186-187	Potato Sacks	158, 203	Ringmaster	153
Leg Press/Hack Squat	246	Multi-Sport Helmets	97, 198	Paralettes	248	Power Cross Challenge Mat	253	River Stones	200
Leg Toner	228	Multi-Sport Net	209	ParaTossers	156, 186	Power Racks	244	Roll Out Ladders	263
Lifting Chains	245	Multi-Use Apparatus	49	Partner Straps	156	PowrPro Soccer Goals	6	Roll Out Lines	121
Limitless Timer	277, 315	Muscle Hustle	279, 330	Pass Rite, Volleyball	44	PowrSKIN Ball Sets	99	Roll-A-Way Game Standards	48
Liquid Lines	37, 121	My First Flybar	180	Passing Arc Set	63	Precher Curl Bench	246	Roller Bags	306
Little Champ Basketall	33	MyPlate Education	331	Peacock Feathers	204	Pre-Tape Spray	293	Roller Racers	198
Locker Room Stools	328	N		Pedometers & Accessories	283	Pre-Wrap	293	Rope Anchors & Brackets	226
Locks	289	Neon Dodgeballs	101, 103	Peekaboo Animal Sleeves	133	Pugg Goals	65	Ropes, Climbing	337
Loloball	202	Net Keepers, Volleyball	47, 51	Peg Board Climbers	248, 339	Pullup Revolution	250	Round Base Goal	4, 142
Long Jump Mats	285	Nets, Badminton	220-221	Pellet Balls	108, 163, 205	Punch Balls	115	Rowing Machines	244
Long Lines	121	Ninja Line	338	Pennant Streamers	82	Punch Mitts	254	Rubber Arrow Sets	124
M		No Handle Parachutes	187	PG Sof	111	Push Up Bars, Mats & Testers	253	Rubber Flooring	254
Marble Maze	155	No Peek Volleyball Net	45	Pickleball	214, 215	Push Up Mats	284	Rubber Spot Sets	122-123, 262
Marble Run	55	Nobbie Balls	110, 131	Ping Pong Tables	211	Push/Pull Sleds, Agility	264	Rubber Star Sets	124
Marine Organisms Bean Bags	160	Numbered Bean Bags	160	Pinnies	118-120	Putting Cups	207, 209	RuffSKIN Foam Ball Sets	102, 103
Marine Wildlife Spot Markers	123	Numbered Flying Discs	171	Scrimmage Vests	118-120	Q		Rugby Balls	55
Marking Chalk	303	Numbered Playground Balls	113	Pirate Wheel	132	Quickster Chipping Net	209	Rumble Roller	132
Massage Ball	270	Numbered Poly Spots	123	Pitching Machine Balls	70	Quickster QB Trainer Net	56	Running Man	154
Massage Bars & Kits	270	Numbered Scrimmage Vests	118	Pitching Rubbers	76	R		Sabakiball	143
Mat Storage	273	Nutrition Education	330, 331	PlasmaCar	198	Race Clock	315	Safe-T Putter	206
Mat Tape	121	O		Plastic Bats	73	Racquet Carts	221, 223	Safety Balls	70, 72
Mat Transporters	346	Oball Classic	109	Plastic Cones	125	Racquetball Equipment	225	Safety Bats	73
Mats	274-275, 344-352			Platform Stilts	203	Racquets, Badminton		Safety Wall Padding	354
Matt-Kleen	346			Play Food Set	331			Sandbag Training	236
Measuring Tapes & Wheels	82, 303			Playballs	98-117			SandBells	235

- Satryan Ball 107, 172
 Scales 287
 Scatter Ball 151
 Scoop Games 149
 Scooter Carts & Storage .. 197
 Scooter Hockey Sets 196
 Scooter Links 196
 Scooters 194-198
 Scooters & Accessories
 9, 194-198
 Scoreboards 318, 319
 Scorebooks 301
 Sea Critter Set 160
 Shield Hockey Sticks... 88, 89
 Shin Guards 97
 Shipping Information.... 355
 Shooting Glove..... 36
 Shot Puts & Discus 80
 Shot Spotz 36, 124
 Shuffleboard Games..... 151
 Shuttlecocks 216, 220
 ShuttleSafe 285
 Sideline Markers, Football ...
 55
 Sidewalk Chalk 164
 Sidewinder Rope..... 182
 Skillastics
 135, 167, 281, 331, 336
 Skill-Shot Target 175
 Skinny Hoops..... 188
 Slam Balls 232
 Sleeve-It Arm Pinnies 120
 Slide Board 257
 Slider Discs..... 252
 Slim Knock Down Pins ... 114
 SlimPins Bowling Pins ... 191
 Slipp-Nott Traction Mats... 37
 SlotCones 79, 125, 269
 Smart Fitness Packages
 234, 280
 Smashminton Set 217
 Snake Cross Challenge... 278
 Soccer Balls58-62
 Soccer Equipment 58-68
 Soccer Goalie Gloves..... 63
 Soccer Goals64-68
 Soccer Nets & Fasteners... 68
 Soccer Shin Guards..... 63
 Soft Polo Sets..... 93
 Softball Equipment.....69-77
 Softey Ball 111
 Speed Chutes 265
 Speed Harness 265, 266, 267
 Speed Rings..... 262
 Speed Ropes .. 184, 185, 251
 Speed Stacks19, 167
 Speed Trainer..... 231
 Speedminton..... 217
 Spider Ball 108
 SpiderGrip Balls 98
 Spike Pal Volleyball Trainer...
 44
 Spikeball 142
 Spikebuoy 291
 Spin Jammer Discs 170
 Spinning Plates..... 205
 Splash & Slam Game 290
 Spooner Boards..... 199
 Spot Challenge Mat 278
 Spot Markers 121-124
 Squat Racks 246
 Stability Balls..... 260
 Stack Mat 167
 Stage Mats & Padding ... 354
 Standards..... 5, 48-50
 Start & Finish Lines...82, 121
 Starter Beams 201
 Starter Pistol & Ammo 81
 Starter Sleeve..... 81
 Starting Blocks..... 81
 Station Board Holders ... 128
 Station Pack 265
 Stiga Table Tennis Tables . 210
 Stilts 203
 Stopwatches 316, 317
 Storage Bins..... 310
 Storage Carts & Racks.....
 51, 256
 Straps & Flags55, 139
 Streamer Ball..... 106
 Stretch Straps..... 270
 Stretching..... 270
 Stretching and Resistance
 Training 228
 Strike Shield 254
 Strkie Mat..... 76
 STX Lacrosse..... 85
 Super Flings..... 105, 147
 SuperCatch..... 149
 SupR-Safe Ball Sets..... 110
 Surge Storm Resistance
 Trainer..... 235
 Suspension Trainers 248, 249
 Swim Belts 291
 Swim Caps & Fins 291
 Swimming Equipment... 291
 Swing Bar..... 342
 Swing Seats 324
T
 Table Tennis..... 210-213
 Table Tennis Balls 213
 Table Tennis Equipment.....
 210-213
 Table Tennis Paddles 213
 Table Tennis To Go ...18, 212
 Tactile Discs 132
 Tail Ball 105, 147
 Takraw Ball 153
 Tally Counter 277, 315
 Tape Layer 121
 Target Balls 137
 Target Mat 2, 136
 Target Zone Game.....
 95, 136, 173
 Targets, Archery 177
 Tchoukball 5, 107, 140
 Teacher Resources.....
 332-334, 336
 Team Bucket Challenge .. 154
 Team Building 19
 Team Connect-A-Chute.....
 156, 186
 Team Relay Puzzles..... 157
 Team Toss Class Pack 163
 Team Transport Challenge 154
 TeamWebs 154
 Tendril Balls.....
 108, 131, 160, 223
 Tennis Carts & Storage... 223
 Tennis Equipment... 222-225
 Tennis Nets & Post Reel
 222, 224, 225
 Terra Core System 280
 Tetherballs 325
 The Step 256
 TheraBand 228-230, 234
 Thermo Grip Balls 104
 Thermo Grip Playballs 4
 Throw Down Bases 76
 Tic Tac Toe Toss Mat 161
 Time Tracker..... 277
 Timers..... 277, 315
 Tinikling Poles..... 181
 Tip N Roll Standards 48
 Tire Cross Challenge..... 278
 Tire Tether 264
 Toning Wheels..... 253
 Tornado Bag..... 235
 ToteMaster Ball Carts ... 309
 Towels..... 295
 Track & Field Equipment
 78-83
 Track Wagon80, 306
 Trampolines..... 257
 Trapezoids, Tumbling.... 343
 Trapp Ball 148
 TravelChair Bench 327
 Traverse Walls 341
 Tricep Ropes..... 245
 TriGoal Net.....65, 143
 Tri-Goal Toss Pack 163
 True Flight Balls.....
 109, 129, 130
 TRX Suspension Trainer .. 249
 Tubing Cart 227
 TuffSKIN Foam Ball Sets.....
 100, 101
 Tug Ball..... 159
 Tug Of War Ropes.. 159, 266
 Tumble-N-Ball 109, 131
 Tunnels & Mazes 166
 TurboJav..... 82
 Twirl N Jump 180
 Twist N Scoot 198
 Two-Fer Double Scooter .. 195
U
 Umpire Equipment 69, 77
 Underwrap Tape 293
 Up 4 It 168
 Utility Balls..... 111
 Utility Car 306
V
 Versa Hurdle 79
 Verti Goals 173
 Vertical Challenger 285
 Verticle Trainer..... 231
 Voit Playground Balls..... 43
 Volleyball Bags & Carts... 45
 Volleyball Equipment . 38-52
 Volleyball Nets..... 4, 49
 Volleyball Practice Station . 44
 Volleyball Training Aids
 44-45
 Volleyballs 38-43
W
 Waffle Bottom Bases..... 77
 Waist Pinnies..... 120
 WAKA Kick Balls ... 112, 153
 Wall Balls 233
 Wall Mount Dip Station .. 248
 Wall Organizers..... 128
 Wall Padding..... 353, 354
 Washer Toss Game 145
 WaTE Ball 234
 Water Balloon Slingshot . 158
 Water Games..... 290
 Water Polo Equipment... 290
 Water Remover, Tennis .. 225
 WaveMaster..... 254
 Weight Lifting Belts 245
 Weight Lifting Equipment....
 240, 242-246
 Weighted Jump Ropes.....
 185, 251
 Weighted Knock Down
 Targets 138, 191
 Weighted Sport Balls 264
 Weighted Vests 236
 Wheelchair Soccer Pad... 129
 Whirl-O-Rope..... 132, 182
 Whistles 300
 Wicked Kick Croquet.... 150
 Wiggle Boards..... 199
 Wireless Speakers..... 313
 Wobble Boards 199
 WonderFoam Block Set .. 164
 Wood Sticks 179
 Workout Mats 274-275
 Wristbands..... 120
 Write-On Spots 124
X
 Xbox Fitness Packs 281
Y
 Yoga Block & Strap 272
 Yoga Cards..... 272
 Yoga Equipment... 272, 273
Z
 Zip Crank Station..... 33
 Zoner Game Set..... 141
 Zume..... 217

SCHOOL HEALTH[®]

HEALTH SERVICES

SPECIAL EDUCATION

SPORTS MEDICINE

EARLY CHILDHOOD

PHYSICAL EDUCATION





School Health Corporation

11711 S. Austin Ave.
Alsip, IL 60803

Source Code

PE

Please mention source code when ordering.

Free Ship Code

60045

Use this code for free shipping on your online order over \$125.* See page 1 for details.

Online PalosSports.com
Phone 800-233-5484
Fax 877-800-5973
E-mail sales@palosports.com
Mail Order form on page 356



PS office use only

9100220

PRSR STD
U.S. POSTAGE
PAID
Palos Sports,
Inc.

BRAINball™

A PHYSICAL EDUCATION LEARNING SYSTEM

"Learning through play."



17 YEARS
OF RESEARCH
PROVEN
TO ENHANCE

- MATH
- READING
- SPELLING
- ADAPTED PE
- FINE MOTOR SKILLS

What is BRAINball™?

BRAINball™ is an innovative and unique physical education learning system that merges physical activity and academic learning through play.

Instructors and students use 100 mini soccer and basketballs and 100 lesson plans to develop math, reading, grammar, spelling, anatomy and foreign language skills. In addition to the physical benefits, significant improvement will be seen in gross and fine motor skills, cooperative and cognitive learning. BRAINball™ can be incorporated into Adapted Physical Education programs as well as those teaching students with learning disabilities, such as dyslexia.

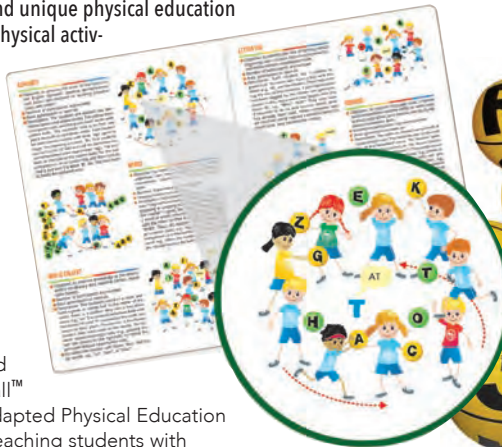

EASY TO FOLLOW INSTRUCTIONS WITH VISUAL AIDS FOR QUICK TEACHING SO THERE'S MORE TIME TO LEARN!



BRAINball™ is broadly adaptable across elementary and secondary grades, and while an excellent tool for physical education, it is also perfect for use in the classroom, after-school, recreation and sports programs.

[VIEW A SAMPLE LESSON PLAN ON OUR WEBSITE!](#)

What does BRAINball™ include?

Each set includes a lesson book filled with 100 games/activities, 100 mini basketballs and soccer balls (size 3) in five colors – red, orange, yellow, blue and green – and premium equipment bags with carry strap. There are 40 yellow and 40 green basketballs with letters (upper & lower case) and numbers, 8 red and 8 blue soccer balls with math symbols, and 4 orange "wild card" (blank) balls. BRAINball™ book is not sold individually.
49082 BRAINball™ Set - 100 balls and 100 lesson plans..... \$789.99 set

CREATED AND DEVELOPED AT THE UNIVERSITY SCHOOL OF PHYSICAL EDUCATION
WROCLAW POLAND



Created by:
Andrzej Rokita PhD, Tadeusz Rzepa PhD and Marek Nowicki
and developed by:
Andrzej Rokita PhD, Ireneusz Cichy PhD, Sara Wawrzyniak PhD
University School of Physical Education
Wrocław, Poland

Sports Medicine | 2020

INJURY PREVENTION • ACUTE CARE • REHABILITATION • SUPPORT



Sign up, Sign in & **SAVE!**

Take
advantage
of special
pricing

Not signed up for special pricing? Go to
SchoolHealth.com/Ecommerce-Solutions

Dear Valued Customer

To our valued customers, we are excited to bring you our 2020 Sports Medicine catalog featuring the latest and greatest solutions for your athletic training room— as well as the tried and true products you rely on.

As you browse these pages be sure to take a look at products for heat-stress monitoring and hydration. Heat illness during physical activity is the leading cause of injury and death among school athletes. Heat-related illness and death are almost entirely preventable, so it is important to establish and follow a proper heat-acclimatization program for hot weather.

You'll also notice the expanded selections of Rehabilitation, Exercise & Strength, and Conditioning products. We have included offerings from our affiliated company, Palos Sports, bringing more options to your athletic training program. With Palos you can support your athletes and allow them to perform to the best of their abilities.







As always, we welcome your feedback and want to continually enhance your experience. Send your comments to marketing@schoolhealth.com.



To good health!
Rob Rogers, President
School Health Corporation

CONNECT WITH US

Online SchoolHealth.com/SportsMed
Phone 866-323-5465 (7 a.m.–5 p.m. CST)
Fax 800-235-1305
Mail Order form on pages 359–360

 facebook.com/esportshealth
 pinterest.com/esportshealth
 twitter.com/esportshealth
 linkedin.com/company/school-health-corp
 youtube.com/schoolhealthcorp
 instagram.com/schoolhealthsports

OUR PROMISE

Since our founding in 1957, School Health has been dedicated to helping school-based health professionals keep their students healthy.

We promise to deliver an unparalleled customer experience so you can support the health of your students and enable them to learn and perform to the best of their abilities.

Thank You for being a valued customer. We look forward to building an even healthier future together.

Contact your local School Health Representative for expert assistance
Toll free: 866-323-5465



If you do not know who your local School Health representative is, please contact your area customer service representative. They are listed below:

1. **WEST**— AK, AZ, CA, HI, ID, MT, NV, OR, UT, WA, WY
Nancy Rusovick, NRusovick@schoolhealth.com
Nikki Cooke, NCooke@schoolhealth.com
2. **WEST CENTRAL**—AR, NM, OK, TX
Annette Powell, APowell@schoolhealth.com
Nikki Cooke, NCooke@schoolhealth.com
3. **MIDWEST**—IA, IL, KS, MN, MO, ND, NE, WI, SD, CO
Melanie Caballes, MCaballes@schoolhealth.com
Joey Laudando, JLaudando@schoolhealth.com
4. **SOUTHEAST**—AL, FL, GA, LA, MS, NC, TN, SC
Hafza Hussain, HHussain@schoolhealth.com
Angelica Ramon, ARamon@schoolhealth.com
5. **MID-ATLANTIC**—IN, KY, MI, VA, WV, DC, MD, DE
Miranda Anthony, MAnthony@schoolhealth.com
Linda Horan, LHoran@schoolhealth.com
6. **NORTHEAST**—NJ, PA, OH
Genevieve Hendle, GHendle@schoolhealth.com
John Johnston, JJohnston@schoolhealth.com
7. **NEW ENGLAND**—CT, MA, ME, NH, NY, RI, VT
Elena Perrone, EPerrone@schoolhealth.com
Brenda Medina, BMedina@schoolhealth.com

New & Featured Products

Shop for new and featured products which have been specially selected by our sports medicine product experts.

4

Athletic Tape & Accessories

- Athletic Tape
- Pre-Wrap
- Kinesiology Tape
- Elastic Wraps
- Prep Solutions & Lubricants

7

Braces & Protective Equipment

- Braces
- Supports
- Compression Sleeves
- Face Masks
- Mouth guards

25

Padding, Casting & Podiatry

- Padding & Felt
- Moleskin
- Heel & Lace Pads
- Casting & Splinting
- Insoles

51

Wound Care & Infection Prevention

- Adhesive Bandages
- Gauze
- Bleeding Control
- Gloves
- Disinfectants
- Biohazard Supplies

69

Therapeutic Modalities

- Hot & Cold Packs
- Compression Systems
- Modalities
- Hydrocollators
- Whirlpools
- Icemakers

97

Rehabilitation & Exercise

- Soft Tissue Instruments
- Massage Cream
- Rollers
- Bands
- Weights
- Exercise Equipment

127

Strength & Conditioning

- Speed & Agility
- Wall Balls & Sleds
- Free Weights & Benches
- Barbells & Plates
- Weight Racks
- Exercise Equipment

151

Hydration & Nutrition

- Bottles
- Cups
- Coolers
- Hydration Systems
- Nutrition
- Hydration Testing

197

Emergency Response & Safety

- Splints
- Backboards
- Crutches
- AEDs
- Weather Monitoring
- Radios

219

Athletic Training Kits & Bags

- Backpacks
- Kits
- Wheeled Bags
- Kit Organizers
- Travel Cases

249

Pharmacy & Instruments

- Prescription Items
- OTC's
- Topical Analgesics
- Antiseptic Cleansers
- Eye & Oral Care
- Instruments

263

Diagnostic & Screening

- Thermometers
- Blood Pressure Cuffs
- Stethoscopes
- Otoscopes
- Scales
- Heart Rate Monitors

291

Athletic Training Room Furnishings

- Tables
- Cabinets
- Carts
- Curtains
- Refrigerators
- Lamps

313

Disposables & General Supplies

- Feminine Supplies
- Tissues & Towels
- Sun Glare Products
- Washcloths
- Exam Garments
- Plastic Bags

339

Educational Aids & Resources

- Concussion Management
- Software
- Reference
- Anatomical Charts
- Models
- CPR Training Aids

349

Ordering info & Index

- Order Form: p. 359-360
- Medical Authorization Form: p. 357
- Index: p. 361

356

New & Featured Products



**NEW! KT PRO
Extreme Skin
Tone Tape**

See page 20

**NEW!
LIFEPAK® CR2
Defibrillator with
LIFELINKcentral™
AED Program
Manager**

See page 222



**NEW!
Wuru Wool**

See page 68

INTRODUCING School Health Brand Alcohol-Free Hand Sanitizer

NEW! A safe, alcohol-free alternative to sanitize hands and surfaces

See page 91



NEW!
Theragun G3
Packages

See page 128



NEW!
Aryse IFAST
Ankle Brace

See page 28

NEW!
Sports Health™
Fitness
Band Loops

See page 143



New & Featured Products



NEW! Ice Makers

See page 109–110

NEW! Expanded Strength & Conditioning Section!

Pages 151–196

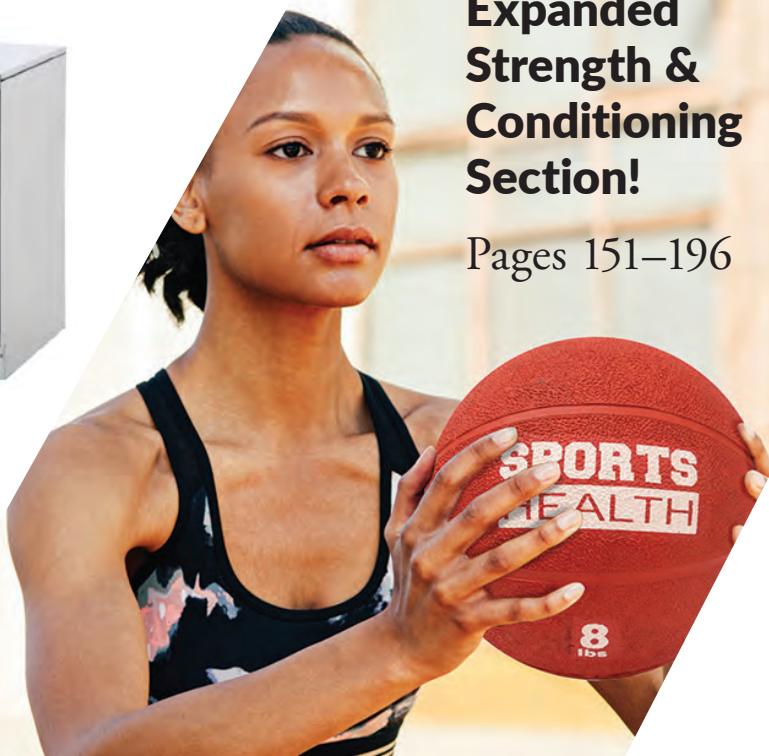

NEW! The Pronator

See page 145

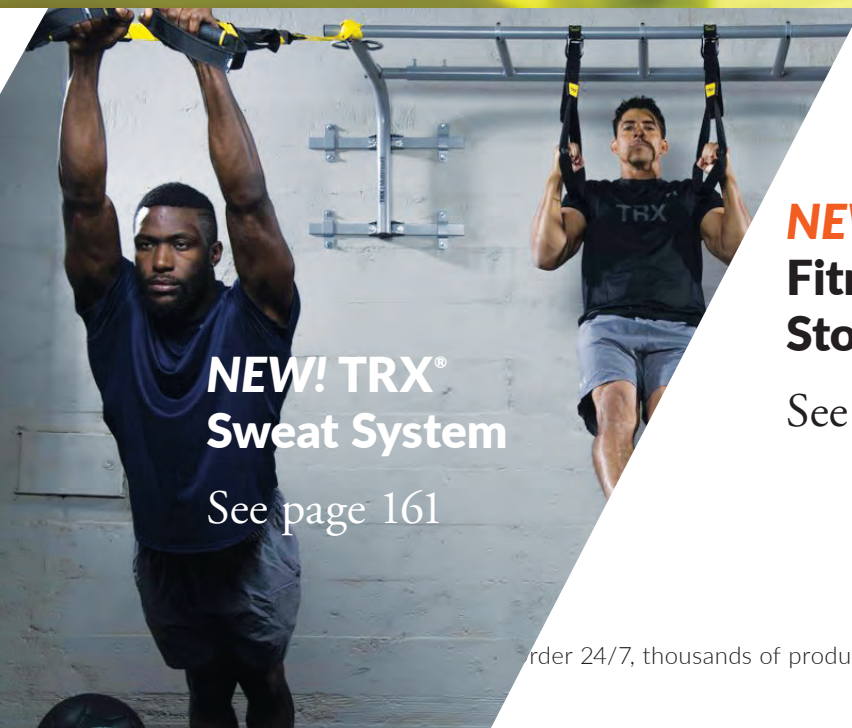

NEW! TRX® Sweat System

See page 161

NEW! Smart Fitness Elite Storage Tower

See page 189



Athletic Tape & Accessories



KT Tape 20

Athletic Tape	8-10
Elastic Tape	11-13
Pre-Wrap	14
Self-Adhesive Tape	15-17
Surgical Tape	18

Specialty Tape	19
Kinesiology Tape	20
Taping Accessories	21-22
Tubular Compression Bandages & Elastic Wraps.....	23
Elastic Wrap	24

Athletic Tape

COMPARE & SAVE!



- High-quality breathable tape
- Provides support to speed recovery after injury
- Economical

SH School Health Brand Athletic Tape

School Health Brand cotton athletic sports tape is easier to tear than traditional athletic tapes. School Health Brand Athletic Tape is made for wrapping hands, ankles, and other body parts for protection and support during sports activities.

1½" x 15 yds., White
32 rolls/case.....**28199** \$53.50 cs.



Cramer® Team Colors Athletic Tape

Zinc oxide cotton tape provides the extra support athletes need.

- Easy hand tear
- High tensile strength
- Highly conformable

1½" x 10 yds., 32 rolls/case

Black	28697	\$77.99 cs.
Blue	28699	\$77.99 cs.
Gold	28700	\$77.99 cs.
Orange	28701	\$77.99 cs.
Pink	28702	\$77.99 cs.
Purple	28703	\$77.99 cs.
Red	28698	\$77.99 cs.



Cramer® 750 Athletic Tape

Computer calibrated unwind for consistency and performance roll-to-roll. A high-quality cotton tape at an affordable price. Zinc oxide tape provides excellent tensile strength and superior conformability.

1½" x 15 yds., White, 32 rolls/case
.....**28513** \$60.99 cs.



Cramer® 950 Porous Athletic Tape

High-quality, economically priced porous tape alternative. Constructed out of 100% cotton backcloth and adhesive.

White

½" x 10 yds., 24 rolls/case 28681	\$36.99 cs.
¾" x 10 yds., 18 rolls/case 28682	\$36.99 cs.
1" x 15 yds., 48 rolls/case 28683	\$64.99 cs.
1½" x 15 yds., 32 rolls/case 28625	\$64.99 cs.
2" x 15 yds., 24 rolls/case 28684	\$64.99 cs.

Not made with Natural Rubber Latex.



Mueller® M-Tape®

- 100% cotton, zinc oxide tape
- High tensile strength with tackiness and conformability
- Colorfast dyes will not bleed

White

1½" x 15 yds., 32 rolls/case	28287	\$68.99 cs.
1" x 10 yds., 48 rolls/case	28641	\$68.99 cs.
2" x 15 yds., 24 rolls/case	28642	\$68.99 cs.

Team Colors

1½" x 10 yds., 32 rolls/case	
Beige	28653 \$78.99 cs.
Black	28650 \$78.99 cs.
Blue	28647 \$78.99 cs.
Gold	28646 \$78.99 cs.
Gray	28655 \$78.99 cs.
Green	28648 \$78.99 cs.
Maroon	28654 \$78.99 cs.
Navy	28657 \$78.99 cs.
Orange	28651 \$78.99 cs.
Pink	28656 \$78.99 cs.
Purple	28652 \$78.99 cs.
Red	28649 \$78.99 cs.



Mueller® Tape Roll Holder

Keep tape at your fingertips with this convenient tape roll holder. Inner divider disc can be moved to create different sized compartments for a variety of tapes and prewrap. Fasten securely with hook-and-loop closure. Supplies not included.

.....	28491	\$9.99 ea.
-------	--------------	------------



Mueller® Perform™ Tape

Reduces irritation and helps the skin to breathe. High tensile strength. 100% cotton with zinc oxide. Superior adhesion and conformability. Delivers consistent unwind to the core.

1½" x 15 yds.	
32 rolls/case	28284 \$77.99 cs.
2" x 15 yds.	
24 rolls/case	28643 \$77.99 cs.



Mueller® Perform Plus™ Tape

With a higher thread count for an even stronger 100% cotton backcloth, Perform Plus™ remains breathable and comfortable on your skin, thanks to the porous nature of this tape. This high-performance zinc oxide tape is serrated for easier tear.

1½" x 15 yds., 32 rolls/case	28691	\$80.99 cs.
2" x 15 yds., 24 rolls/case	28692	\$80.99 cs.

Athletic Tape



J&J COACH® Athletic Tape Speed Packs

(5188) 1½" x 15 yds., 32 rolls/case. **28026** \$79.99 cs.

J&J ZONAS® Athletic Tape Speed Packs

Extremely easy to unwind from the roll, assuring use of the entire length.

Porous

(5190) 1½" x 15 yds., 32 rolls/case. **28024** \$84.99 cs.

J&J ZONAS® Porous Box Tape

(5104) 1" x 10 yds., 12 rolls/box **28030** \$21.50 box

(5106) 2" x 10 yds., 6 rolls/box **28032** \$21.50 box

Andover® PowerPro Synthetic Adhesive Tape

PowerPro Synthetic Adhesive Tape is Andover's latest innovation in taping systems. This tape stretches less than 1%, has pressure sensitive adhesive, and is sweat and water-resistant. If you are an athletic trainer who likes working with premium adhesive tapes, but doesn't like the unsupportive stretch of traditional cotton tape, look no further than PowerPro.

White

1" x 15 yds., 48 rolls/case. **1006754** \$80.99 cs.

1½" x 15 yds., 32 rolls/case. **1006755** \$80.99 cs.

2" x 15 yds., 24 rolls/case. **1006756** \$80.99 cs.

Black

1" x 15 yds., 48 rolls/case. **1006757** \$87.99 cs.

1½" x 15 yds., 32 rolls/case. **1006758** \$87.99 cs.

2" x 15 yds., 24 rolls/case. **1006759** \$87.99 cs.

Jaybird & Mais® EX1

Manufactured using a higher thread count fabric for greater tensile strength.

- Bleached white cloth
- Hypoallergenic adhesive

1" x 15 yds., 48 rolls/case. **28292** \$72.99 cs.

1½" x 15 yds., 32 rolls/case. **28201** \$72.99 cs.

2" x 15 yds., 24 rolls/case. **28293** \$72.99 cs.

Jaybird & Mais® Pro EX25

Adhesive tape with excellent adhesion and tensile strength properties. Bleached white cloth. Soft and supple cloth. Hypoallergenic adhesive.

1" x 15 yds., 48 rolls/case. **28294** \$67.99 cs.

With SEC Serrated Ends
1½" x 15 yds., 32 rolls/case. **28295** \$67.99 cs.

Jaybird & Mais® MedPak Black Tape

½" x 10 yds., 24/box **28423** \$19.99 box

1" x 10 yds., 12/box. **28424** \$19.99 box

Jaybird & Mais® Athletic Trainer's Tape 20C

Black athletic tape. Strong, but hand tearable. Rubber-based, zinc oxide adhesive. Dyed cloth. Hypoallergenic adhesive.

1½" x 15 yds., 32 rolls/case

Black **28205** \$74.99 cs.

Elastic Tape—Light Stretch



Mueller® Tear-Light™

White

1½" x 7½ yds., 32 rolls/case.....	28127	\$69.99 cs.
2" x 7½ yds., 24 rolls/case.....	28128	\$69.99 cs.
3" x 7½ yds., 16 rolls/case.....	28129	\$69.99 cs.

Black

2" x 7½ yds., 24 rolls/case.....	28261	\$75.99 cs.
3" x 7½ yds., 16 rolls/case.....	28262	\$75.99 cs.



Mueller® Colored Tear-Light™

2" x 7½ yds., 24 rolls/case

Blue.....	28758	\$77.99 cs.
Gold.....	28759	\$77.99 cs.
Green.....	28757	\$77.99 cs.
Pink.....	28756	\$77.99 cs.
Red.....	28755	\$77.99 cs.



BSN-JOBST Lightplast® Pro Athletic Tape

Elastic cotton/spandex blend handles many taping, strapping tasks. Tears easily. Excellent adhesion. Resists moisture. Air permeable.

White

1" x 5 yds., 48 rolls/case.....	28240	\$92.99 cs.
1½" x 5 yds., 32 rolls/case.....	28189	\$92.99 cs.
2" x 5 yds., 24 rolls/case.....	28190	\$92.99 cs.
3" x 5 yds., 16 rolls/case.....	28191	\$92.99 cs.
2" x 7½ yds., 24 rolls/case.....	28192	\$97.99 cs.
3" x 7½ yds., 16 rolls/case.....	28193	\$97.99 cs.

Black

2" x 5 yds., 24 rolls/case.....	28275	\$92.99 cs.
3" x 5 yds., 16 rolls/case.....	28276	\$92.99 cs.



Cramer® Pro-Lastic Tear Stretch Tape

Highly conformable, hand tear stretch tape that provides adequate support for strains, sprains and muscle injuries. 100% cotton backcloth.

White

2" x 7½ yds., 24/case.....	28626	\$74.99 cs.
3" x 7½ yds., 16/case.....	28627	\$74.99 cs.

Black

2" x 7½ yds., 24/case.....	28628	\$74.99 cs.
3" x 7½ yds., 16/case.....	28629	\$74.99 cs.

Not made with Natural Rubber Latex.

Elastic Tape—Light Stretch



HARTMANN Pro's Choice®

1" x 5 yds., 48 rolls/case28283	\$81.99 cs.
1½" x 5 yds., 32 rolls/case28250	\$81.99 cs.
2" x 5 yds., 24 rolls/case28251	\$81.99 cs.
3" x 5 yds., 16 rolls/case28252	\$81.99 cs.
1½" x 7½ yds., 32 rolls/case28196	\$87.99 cs.
2" x 7½ yds., 24 rolls/case28197	\$87.99 cs.
3" x 7½ yds., 16 rolls/case28198	\$87.99 cs.

Covidien® Ultra-Light

Hypoallergenic, lightweight. Consistent unwind tension and superior strength.

1½" x 7½ yds., 32 rolls/case28061	\$81.99 cs.
2" x 7½ yds., 24 rolls/case28062	\$81.99 cs.
3" x 7½ yds., 16 rolls/case28063	\$81.99 cs.

Covidien® Sher-Light®

Elastic adhesive athletic tape. Hypoallergenic—apply directly to the skin. Lightweight conformity to body parts. Superior strength that holds up to the most strenuous athletic demands.

White

2" x 5 yds., 24 rolls/case28246	\$77.99 cs.
3" x 5 yds., 16 rolls/case28247	\$77.99 cs.
1½" x 7½ yds., 32 rolls/case28179	\$77.99 cs.
2" x 7½ yds., 24 rolls/case28180	\$77.99 cs.
3" x 7½ yds., 16 rolls/case28181	\$77.99 cs.

Black

2" x 7½ yds., 24 rolls/case28716	\$77.99 cs.
3" x 7½ yds., 16 rolls/case28717	\$77.99 cs.



Jaybird & Mais® 4500 Jaylastic White

Light, hand-tearable stretch tape. Hypoallergenic.

1" x 5 yds., 48 rolls/case28210	\$53.99 cs.
1½" x 5 yds., 32 rolls/case28211	\$53.99 cs.
2" x 5 yds., 24 rolls/case28212	\$53.99 cs.
3" x 5 yds., 16 rolls/case28213	\$53.99 cs.
1" x 7½ yds., 48 rolls/case28206	\$63.99 cs.
1½" x 7½ yds., 32 rolls/case28207	\$63.99 cs.
2" x 7½ yds., 24 rolls/case28208	\$63.99 cs.
3" x 7½ yds., 16 rolls/case28209	\$63.99 cs.

Jaybird & Mais® 4500 Jaylastic Black

1" x 7½ yds., 48 rolls/case28291	\$73.99 cs.
2" x 7½ yds., 24 rolls/case28273	\$73.99 cs.
3" x 7½ yds., 16 rolls/case28274	\$74.99 cs.

Jaybird & Mais® 4600 Jaylastic White

Premium bleached white stretch fabric tape which is hand tearable. It has increased unwind tension and firm roll density.

2" x 7½ yds., 24 rolls/case28449	\$69.99 cs.
3" x 7½ yds., 16 rolls/case28450	\$69.99 cs.



Arrowhead® Thin-Flex Stretch "N" Tear Tape

Thin for superior flexibility and comfort. Strong with excellent elongation. Easy to tear, also tears lengthwise.

White

2" x 7½ yds., 24 rolls/case28428	\$65.99 cs.
3" x 7½ yds., 16 rolls/case28429	\$65.99 cs.

Black

3" x 5 yds., 16 rolls/case28481	\$71.99 cs.
2" x 7½ yds., 24 rolls/case28430	\$69.99 cs.
3" x 7½ yds., 16 rolls/case28431	\$69.99 cs.

 Not made with Natural Rubber Latex.

Elastic Tape—Maximum Stretch



HARTMANN Medical AC-Tape® Plus™

High-twist cotton yarn, high-strength tape. Soft feathered edges. Aggressive adhesion. Wide core allows full unwind.

Box Tape

2" x 5 yds., 6 rolls/box.	28253	\$29.99 box
3" x 5 yds., 4 rolls/box.	28254	\$29.99 box

Team Packs

2" x 5 yds., 24 rolls/case.	28249	\$102.99 cs.
3" x 5 yds., 16 rolls/case.	28248	\$102.99 cs.

HARTMANN AC-Tape®

High-strength, cotton, elastic adhesive tape. Delivers unmatched strength and security. Conforms to any contour without restricting movement.

Box Tape

1" x 5 yds., 12 rolls/box	28153	\$27.99 box
2" x 5 yds., 6 rolls/box.	28154	\$27.99 box
3" x 5 yds., 4 rolls/box.	28155	\$27.99 box
4" x 5 yds., 6 rolls/box.	28156	\$54.99 box

Athletic Packs

2" x 5 yds., 24 rolls/case.	28157	\$71.99 cs.
3" x 5 yds., 16 rolls/case.	28158	\$72.99 cs.

Mueller® Stretch M-Tape Premium

Maximum strength elastic adhesive tape for areas and techniques normally difficult to tape. Superior adhesive and tensile strength. Red center guideline helps for consistent taping. Soft featured edges won't roll up when putting on athletic pants or shorts.

2" x 5 yds., stretched, 24 rolls/case.	28488	\$64.99 cs.
3" x 5 yds., stretched, 16 rolls/case.	28489	\$64.99 cs.
1" x 5 yds., 32 rolls/case.	1031531	\$64.99 cs.

Mueller® Flexlight Tape (Formerly Spatting Tape)

Improved lightweight elastic adhesive tape is ideal for spatting shoes to help secure cleats or cover logos. Lighter, stronger design can also be used to secure braces and padding. Easy to tear. Now available in white and black.

Black

2" x 7½ yds., 24 rolls/case	28637	\$78.99 cs.
3" x 7½ yds., 16 rolls/case	28638	\$78.99 cs.

White

2" x 7½ yds., 24 rolls/case	28639	\$78.99 cs.
3" x 7½ yds., 16 rolls/case	28640	\$78.99 cs.

Pink

2" x 7½ yds., 24 rolls/case	28693	\$79.99 cs.
---------------------------------------	--------------	-------------



Mueller® Recoil™ Tape

This hyper-elastic cohesive tape stretches three times its original length—then recovers nearly 100%! Recoil Tape is super thin and water-resistant, making it perfect for a multitude of applications.

This unique tape will allow you to do things with tape you couldn't before, it's great for augmenting other tapes and provides great compression for bleeding control.

White, 10 rolls/case

1" x 1.4 yds.	1008087	\$24.99 cs.
2" x 1.4 yds.	1008088	\$42.99 cs.
3½" x 1.4 yds.	1008089	\$70.99 cs.

Black, 10 rolls/case

1" x 1.4 yds.	1008090	\$24.99 cs.
2" x 1.4 yds.	1008091	\$42.99 cs.



J&J ELASTIKON® Tape

Excellent where maximum strength and conformability are prime requirements.

Speed Packs

(5170) 2" x 2½ yds., stretched 5 yds. 24 rolls/case	28107	\$99.99 cs.
(5171) 3" x 2½ yds., stretched 5 yds. 16 rolls/case	28108	\$99.99 cs.

Box Tape

(5172) 1" x 2½ yds., stretched 5 yds. 12 rolls/box	28034	\$30.99 box
(5174) 2" x 2½ yds., stretched 5 yds. 6 rolls/box	28035	\$30.99 box
(5175) 3" x 2½ yds., stretched 5 yds. 4 rolls/box	28036	\$30.99 box
(5177) 4" x 2½ yds., stretched 5 yds. 6 rolls/box	28037	\$55.99 box



BSN-JOBST Tensoplast® (Formerly Elastoplast)

Helps control and reduce post-injury edema. Highly twisted crepe yarn provides elasticity.

5 yds.		
1", 32 rolls/case.	28087	\$84.99 cs.
2", 24 rolls/case	28088	\$108.99 cs.
3", 16 rolls/case	28089	\$108.99 cs.
4", 16 rolls/case	28090	\$140.99 cs.

Jaybird & Mais 5000 Jaylastic Plus II

Heavyweight, 100% cotton, short stretch tape with aggressive hypoallergenic adhesive and an easy to work with fabric.

Tan, 5 yds.

1", 48 rolls/case	28296	\$63.99 cs.
2", 24 rolls/case	28214	\$63.99 cs.
3", 16 rolls/case	28215	\$63.99 cs.

Not made with Natural Rubber Latex.

Pre-Wrap

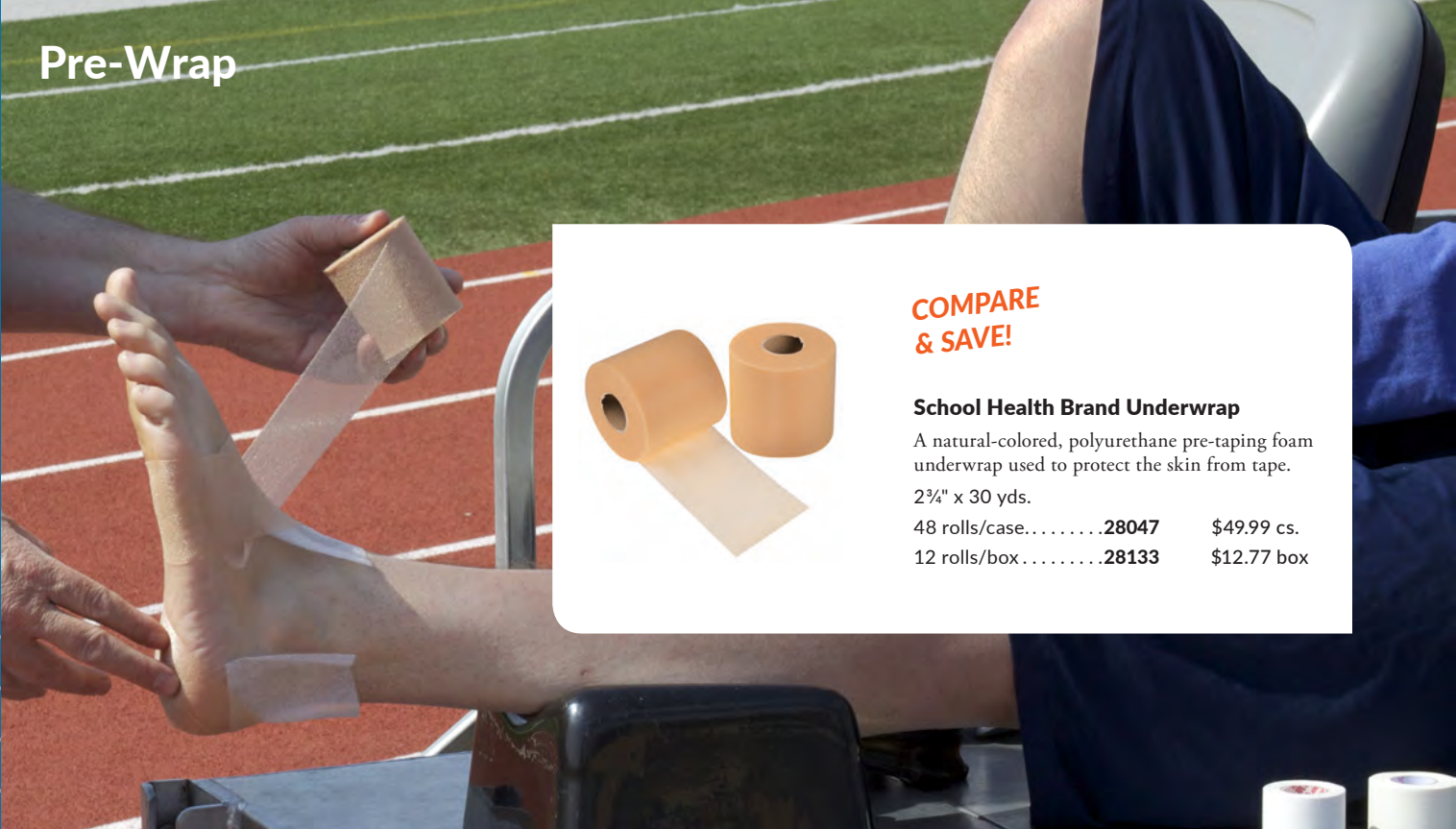

COMPARE & SAVE!

School Health Brand Underwrap
 A natural-colored, polyurethane pre-taping foam underwrap used to protect the skin from tape.
 2¾" x 30 yds.
 48 rolls/case.....**28047** \$49.99 cs.
 12 rolls/box.....**28133** \$12.77 box



Cramer® Colored Underwrap

Used to help eliminate skin irritation caused by repeated taping and to secure cold packs and bandages.

2¾" x 30 yds., 48 rolls/case

Black	28390	\$53.99 cs.
Beige	28500	\$53.99 cs.
Blue	28277	\$53.99 cs.
Green	28505	\$53.99 cs.
Orange	28506	\$53.99 cs.
Pink	28507	\$53.99 cs.
Purple	28504	\$53.99 cs.
Red	28501	\$53.99 cs.
Yellow	28503	\$53.99 cs.



Mueller® M-Wrap® Colors

2¾" x 30 yds., 48 rolls/case

Black	28065	\$51.99 cs.
Natural	28263	\$51.99 cs.
Aqua	28666	\$51.99 cs.
Blue	28243	\$51.99 cs.
Gold	28403	\$51.99 cs.
Green	28402	\$51.99 cs.
Lime Green	28490	\$51.99 cs.
Maroon	28406	\$51.99 cs.
Navy	28633	\$51.99 cs.
Orange	28404	\$51.99 cs.
Pink	28399	\$51.99 cs.
Purple	28405	\$51.99 cs.
Red	28057	\$51.99 cs.
Sunburst	28665	\$51.99 cs.



Andover PowerFAST Stretch Tape

A strong, flexible adhesive stretch tape made of synthetic fabric. Thin and comfortable, PowerFAST won't absorb water and retains elasticity to provide long-lasting support.

1" x 7½ yds., 48/case		2" x 5 yds., 24/case	
White 28532	\$54.99 cs.	Black 28554	\$44.99 cs.
Black 28535	\$54.99 cs.	White 28551	\$44.99 cs.
1" x 5 yds., 48/case		3" x 7½ yds., 16/case	
White 28550	\$44.99 cs.	Black 28537	\$54.99 cs.
Black 28553	\$44.99 cs.	White 28534	\$54.99 cs.
2" x 7½ yds., 24/case		3" x 5 yds., 16/case	
Black 28536	\$54.99 cs.	Black 28555	\$44.99 cs.
White 28533	\$54.99 cs.	White 28552	\$44.99 cs.

HARTMANN Medi-Rip® Self-Adherent Bandage

Tan			
1" x 5 yds., 24 rolls/box	28142	\$44.99 box	
2" x 5 yds., 12 rolls/box	28143	\$44.99 box	
3" x 5 yds., 12 rolls/box	28144	\$47.99 box	
4" x 5 yds., 12 rolls/box	28145	\$55.99 box	
Athletic Team Packs, Tan			
2" x 5 yds., 24 rolls/case	28023	\$64.99 cs.	
3" x 5 yds., 16 rolls/case	28053	\$64.99 cs.	

HARTMANN Pro's Choice® Cohesive Tape

Multipurpose tape for multiple applications. Controlled stretch for controlled compression. Performs wet or dry and won't stick to skin or hair. Tears easily and stays secure.

White			
2" x 6 yds., 24 rolls/case	28397	\$67.99 cs.	
3" x 6 yds., 16 rolls/case	28398	\$67.99 cs.	



Andover VictoryTape™

Economical, cohesive athletic tape. Apply over PowerFlex for a strong, long-lasting taping system. Less than 1% stretch, eliminating the "give". VictoryTape and PowerFlex mold together, creating a taping system with better conformability and comfort. The system is sweat and water-resistant, remaining supportive and stable.

White			
1" x 15 yds., 48 rolls/case	28678	\$52.99 cs.	
1½" x 15 yds., 32 rolls/case	28679	\$52.99 cs.	
2" x 15 yds., 24 rolls/case	28680	\$52.99 cs.	
Black			
1" x 15 yds., 48 rolls/case	28688	\$56.99 cs.	
1½" x 15 yds., 32 rolls/case	28689	\$56.99 cs.	
2" x 15 yds., 24 rolls/case	28690	\$56.99 cs.	

Andover PowerSpeed™ Tape

A cohesive athletic wrap designed for speed taping or for a stronger spat. It is 30% stronger than standard PowerFlex delivering maximum support for a modified taping system. It won't slip/migrate from wear or water, and tears easily by hand for quick application.

White			
2" x 6 yds., 24/case	28568	\$49.99 cs.	
2¾" x 6 yds., 16/case	28569	\$49.99 cs.	
3" x 6 yds., 16/case	28570	\$49.99 cs.	
Black			
2" x 6 yds., 24/case	28571	\$49.99 cs.	
2¾" x 6 yds., 16/case	28572	\$49.99 cs.	
3" x 6 yds., 16/case	28573	\$49.99 cs.	



Self-Adhesive Tape



Mueller® Premium TapeWrap™

Premium performance and woven, ultra-soft fabric. Cohesive, breathable, lightweight and easy-to-tear.

2" x 6 yds., 24 rolls/case

Black28451	\$46.99 cs.
White28418	\$46.99 cs.
Beige28748	\$46.99 cs.
Blue28749	\$46.99 cs.
Gold28752	\$46.99 cs.
Gray28746	\$46.99 cs.
Green28753	\$46.99 cs.
Orange28747	\$46.99 cs.
Pink28751	\$46.99 cs.
Purple28754	\$46.99 cs.
Red28750	\$46.99 cs.

3" x 6 yds., 16 rolls/case

Black28456	\$46.99 cs.
White28419	\$46.99 cs.



Arrowhead® Arrow Flex CO

Arrow Flex CO is a premium stretch cohesive tape designed and built in the USA by Arrowhead Athletics. Arrow Flex CO has smooth stretch and return, easy tear, and outstanding self-grip, while being stronger than many other cohesive stretch tapes on the market. It breathes well and is water-resistant, able to repel moisture even when submerged. Can be used as a tape alone and is able to repel moisture as an underwrap for a secure tape job. This product contains dry natural rubber.

White

2" x 7½ yds., 24 rolls/case	1006768	\$43.99 cs.
-----------------------------------	----------------	-------------

Black

2" x 7½ yds., 24 rolls/case	1006769	\$43.99 cs.
-----------------------------------	----------------	-------------



Cramer® Eco Flex Cohesive Stretch Tape

Non-woven alternative to Cramer Cohesive tape. Provides excellent support and adherence. Works great as underwrap or a wound dressing.

2" x 6 yds., 24 rolls/case

Black28518	\$43.99 cs.
White28516	\$43.99 cs.
Beige28696	\$43.99 cs.
Blue28694	\$43.99 cs.
Gray28695	\$43.99 cs.
Pink28645	\$43.99 cs.
Red28714	\$43.99 cs.

3" x 6 yds., 16 rolls/case

Black28519	\$43.99 cs.
White28517	\$43.99 cs.
Beige28715	\$43.99 cs.



Arrowhead® Co-Tape

Co-Tape is a rigid cohesive tape that tears cleanly by hand, unwinds consistently throughout the roll, and sticks tightly to itself without sticking to skin, clothing, pads, or other surfaces. This product contains dry natural rubber.

White

1½" x 15 yds., 32 rolls/case	1006770	\$47.99 cs.
------------------------------------	----------------	-------------



Andover PowerFlex®

Specially designed fabric tears clean at the desired length, without loose threads. Remains flexible, while providing consistent support. Water-repellent and lightweight. Sticks better to itself.

1" x 6 yds., 48 rolls/case		2 3/4" x 6 yds., 16 rolls/case	
Black 28168	\$43.99 cs.	Black 28171	\$43.99 cs.
White 28163	\$43.99 cs.	White 28166	\$43.99 cs.
Gray 28239	\$43.99 cs.	Pink 28620	\$43.99 cs.
Pink 28617	\$43.99 cs.	3" x 6 yds., 16 rolls/case	
1 1/2" x 6 yds., 32 rolls/case		Black 28172	\$43.99 cs.
Black 28169	\$43.99 cs.	Blue 28268	\$43.99 cs.
White 28164	\$43.99 cs.	White 28167	\$43.99 cs.
Gray 28238	\$43.99 cs.	Gray 28237	\$43.99 cs.
Pink 28618	\$43.99 cs.	4" x 6 yds., 12 rolls/case	
2" x 6 yds., 24 rolls/case		Black 28741	\$43.99 cs.
Black 28170	\$43.99 cs.	3" x 6 yds., 16 rolls/case	
White 28165	\$43.99 cs.	Green 28452	\$43.99 cs.
Gray 28236	\$43.99 cs.	Yellow 28453	\$43.99 cs.
Blue 28269	\$43.99 cs.	Pink 28621	\$43.99 cs.
Green 28271	\$43.99 cs.	2 3/4" x 6 yds., 48 rolls/case	
Yellow 28270	\$43.99 cs.	White 28245	\$119.99 cs.
Red 28432	\$43.99 cs.	3" x 6 yds., 16 rolls/case	
Pink 28619	\$43.99 cs.	White 28433	\$43.99 cs.
		3" x 6 yds., 48 rolls/case	
		Red 28675	\$119.99 cs.



THOR™ Rigid Cohesive Tape

THOR Rigid Cohesive Tape offers the superior control and easy manipulation athletic trainers need. Engineered to work perfectly with Mueller Tapewrap Premium to create an unrivaled rigid tape system with strong heel locks, precise figure 8s, and superb seating of strips.

Features:

- Strong, dual-layer mesh construction
- Easy to tear
- Water and sweat-resistant
- Breathable materials
- Thin and lightweight

1 1/2" x 15 yds., 32 rolls/case **1008086** \$54.99 cs.

Andover PowerTape™

Used in combination, PowerFlex and PowerTape™ create the ultimate taping system, providing the strongest taping system in existence. Remains stable and supportive. Has the same tensile strength as traditional tape and has great lay-in. Sweat-resistant, yet "breathes". Can be used under water.

White, 15 yds.		Black, 15 yds.	
1", 48 rolls/case		1", 48 rolls/case	
. 28677	\$59.99 cs. 28685	\$72.99 cs.
1 1/2", 32 rolls/case		1 1/2", 32 rolls/case	
. 28391	\$59.99 cs. 28686	\$72.99 cs.
2", 24 rolls/case		2", 24 rolls/case	
. 28392	\$59.99 cs. 28687	\$72.99 cs.

Andover CoFlex AFD

An all-in-one wound care product. Its highly absorbent foam pad is attached to our quick-stick CoFlex LF2 for quick and easy application. It sticks to itself without clips or fasteners, while providing controlled compression. A waterproof film layer prevents leakage, drying out and contamination.

Tan, Non-sterile, 2 1/2 yds.		Tan, Sterile, 2 1/2 yds.	
2", 16 rolls/case		2", 16 rolls/case	
. 28574	\$64.99 cs. 28577	\$106.99 cs.
6", 8 rolls/case		4", 8 rolls/case	
. 28576	\$65.99 cs. 28578	\$75.99 cs.
		6", 8 rolls/case	
	 28579	\$75.99 cs.

Andover PowerFlex AFD

White, 2 1/2 yds.			
2", 16 rolls/case 28468			\$33.99 cs.
4", 8 rolls/case 28470			\$33.99 cs.
Black, 2 1/2 yds.			
2", 16 rolls/case 28469			\$33.99 cs.
4", 8 rolls/case 28471			\$33.99 cs.
Sterile-White, 2 1/2 yds.			
2", 16 rolls/case 28472			\$54.99 cs.
4", 8 rolls/case 28473			\$54.99 cs.



BSN Lightplast Cohesive Tape

Self-adherent/cohesive bandage with stronger tensile strength. Soft, porous, and tearable. Provides good compression and support, without restricting mobility.

White			
2" x 6 yds., 24/case 28526			\$51.99 cs.
3" x 6 yds., 16/case 28527			\$51.99 cs.
Black			
2" x 6 yds., 24/case 28528			\$51.99 cs.
3" x 6 yds., 16/case 28529			\$51.99 cs.

Not made with Natural Rubber Latex.

Surgical Tape



3M™ Hypoallergenic Surgical Tape

Blenderm™

Flexible, waterproof, transparent plastic tape.

½" x 5 yds., 24 rolls/box	28066	\$29.25 box
1" x 5 yds., 12 rolls/box	28067	\$29.25 box

Microfoam™

General purpose paper tape. Gentle on skin and very porous.

½" x 10 yds., 24 rolls/box	28069	\$16.35 box
1" x 10 yds., 12 rolls/box	28072	\$16.35 box

Transpore™

Transparent, easy to tear; perforated, porous.

½" x 10 yds., 24 rolls/box	28109	\$27.60 box
1" x 10 yds., 12 rolls/box	28110	\$27.60 box

Durapore™

"Silk-like" cloth tape with strong adhesion and high strength.

½" x 10 yds., 24 rolls/box	28111	\$25.95 box
1" x 10 yds., 12 rolls/box	28112	\$25.95 box

Microfoam™

Conformable elastic foam tape for compression applications or securing dressings.

1" x 5½ yds., 12 rolls/box	28134	\$41.99 box
2" x 5½ yds., 6 rolls/box	28135	\$41.99 box



Kendall CURASILK™ Hypoallergenic Cloth Tape

Ideal for taping catheters, IV tubing, and holds dressings securely in place where extra strength is needed.

½" x 10 yds., 24/box	28443	\$22.30 box
1" x 10 yds., 12/box	28444	\$21.90 box
2" x 10 yds., 6/box	28445	\$21.90 box

Dukal Surgical Tape

Hypoallergenic.

Dukal Hypo-Clear™ Surgical Tape

½" x 10 yds., 24 rolls/box	28173	\$21.50 box
1" x 10 yds., 12 rolls/box	28174	\$21.50 box

Dukal Hypo-Silk™ Cloth Surgical Tape

½" x 10 yds., 24 rolls/box	28175	\$20.50 box
1" x 10 yds., 12 rolls/box	28176	\$20.50 box

Dukal Hypo-Pore™ Paper Surgical Tape

½" x 10 yds., 24 rolls/box	28177	\$13.80 box
1" x 10 yds., 12 rolls/box	28178	\$13.80 box

Transparent Surgical Tape—Economy

1" x 10 yds., 12 rolls/box	28278	\$13.65 box
2" x 10 yds., 6 rolls/box	28279	\$13.65 box

Cloth Tape—Economy

½" x 10 yds., 24 rolls/box	28280	\$16.60 box
1" x 10 yds., 12 rolls/box	28281	\$16.60 box
2" x 10 yds., 6 rolls/box	28282	\$16.60 box



Waterproof Adhesive Tape

½" x 5 yds.	28014	\$1.99 roll
½" x 10 yds.	28016	\$2.66 roll
1" x 5 yds.	28015	\$2.95 roll
2" x 5 yds.	28003	\$4.30 roll
Tri-wide Tape, 2" x 5 yds.; ½", ⅝", ¾" cuts ...	28018	\$4.39 roll

 Not made with Natural Rubber Latex.



Leukotape® P Sports Tape
 1½" x 15 yds. **28105** \$10.99 roll



HARTMANN Omnifix® 
 Paper backing has wavy slits to improve use and speed of application.
 2" x 10 yds. **28255** \$12.75 roll
 4" x 10 yds. **28256** \$18.85 roll
 6" x 10 yds. **1006484** \$21.99 roll

SECURES DRESSINGS WITHOUT ADDITIONAL TAPES!



Cover-Roll® 
 This unique product, conforms to flat or curved areas of the body as it retains dressings, without additional tapes. It has a wonderfully reliable and gentle adhesive that is an excellent choice for sensitive skin. Offers the convenience of a single-sheet taping method over dressings, covering the entire wound site. Air and exudate permeable.
 2" x 2 yds. **27226** \$6.06 roll
 4" x 2 yds. **27116** \$33.99 roll
 2" x 10 yds. **27114** \$15.99 roll
 4" x 10 yds. **27115** \$25.99 roll
 6" x 10 yds. **27116** \$33.99 roll
 8" x 10 yds. **27253** \$44.10 roll



A. Mueller® PTape™
 PTape is a rigid strapping tape with serrated edges for easy tearing.
Features:
 • Helps provide support to weak or injured body parts, such as patella taping on a knee
 • Tape allows for strong pulling action and anchoring
 • Works great with Mueller ProStrips®
 1½" x 15 yds., 6 rolls/case **1007249** \$30.99 cs.

B. Mueller® Pro Strips™
 Breathable adhesive mesh; pressure sensitive strips adhere to skin. Protects against turf burns, scrapes, blisters, calluses, and other abrasions.

Forehead	Team Packages	
2" x 5", 24/pkg.	2" x 10 yds.	
..... 29289 29291	\$22.99 roll
\$13.80 pkg.		
Elbow	4" x 10 yds.	
4" x 8", 24/pkg. 29292	\$29.99 roll
..... 29290	6" x 10 yds.	
\$21.00 pkg. 29293	\$34.99 roll
Finger		
½" x 10 yds.		
..... 54660		
\$21.99 roll		



Mueller® PFTape™ System for Plantar Fasciitis
 Stay active with instant relief from plantar fasciitis.
Features:
 • Patented breakthrough treatment for heel and arch pain
 • One-time use support system designed for rapid heel pain relief
 • Easy to apply
 • No need to cut or modify
 • Fits most men's and women's feet
 7/pkg. **1003599** \$21.99 pkg.
 56/pkg. **1006752** \$129.99 pkg.
 XL Size, 56/pkg. **1006081** \$122.99 pkg.

 Not made with Natural Rubber Latex.

Kinesiology Tape



TheraBand™ Kinesiology Tape

Eliminates misapplication—even for beginners—with exclusive XactStretch Technology. Stretch guide indicators allow users to get the right stretch, every time. This tape sticks and provides durable support for up to 5 days.

Bulk Continuous Roll in Dispenser Box, 2" x 103.3'

Black/Black	1003462	\$92.99 roll
Black/Gray	1003463	\$92.99 roll
Beige/Beige	1003464	\$92.99 roll
Blue/Blue	1003465	\$92.99 roll
Precut Strip Roll in Dispenser Box, (20) 2" x 10"		
Black/Gray	1003468	\$17.99 roll
Black/White	1003469	\$17.99 roll
Standard Continuous Rolls, 2" x 16.4', 6 rolls/pkg.		
Black/Black	1003470	\$59.99 pkg.
Beige/Beige	1003471	\$59.99 pkg.
Blue/Blue	1003472	\$59.99 pkg.



Mueller® Kinesiology Tape

Designed to help increase the natural blood flow around the muscle and features a revolutionary wave pattern adhesive that moves with the skin and muscles. Water-resistant, can be worn up to 5 days.

2" x 16.4 ft., 6/case

Beige	28522	\$58.99 cs.
Black	28523	\$58.99 cs.
Blue	28524	\$58.99 cs.
Pink	28525	\$58.99 cs.
2" x 98.4 ft., 6/case		
Beige	54664	\$39.99 cs.
Black	54661	\$39.99 cs.
Blue	54662	\$39.99 cs.
Pink	54663	\$39.99 cs.



A. KT PRO Extreme Skin Tone Tape

Elastic sports tape that offers pain relief and support for athletes of all skin tones. This tape offers effective support during strenuous activity, and can be worn for 4–7 days at a time.

Tempo Taupe	1034714	\$19.99 ea.
Warm-up Walnut	1034715	\$19.99 ea.
Cameo Caramel	1034716	\$19.99 ea.
Marquee Mocha	1034717	\$19.99 ea.

B. KT Tape Pro

The world's only 100% synthetic microfiber kinesiology tape, KT Tape Pro can be worn for 4–7 days at a time. It is designed to be used during strenuous activity and in harsh conditions, such as humidity, cold, and even the pool.

20 Pre-Cut 10" Strips, Beige	1006365	\$21.99 pkg.
20 Pre-Cut 10" Strips, Black	1006364	\$21.99 pkg.
16' Roll, Beige	1006362	\$21.99 pkg.
16' Roll, Black	1006363	\$21.99 pkg.
Pre-Cut, 10", Jumbo 150, Roll, Black.....	1006767	\$99.99 pkg.
Jumbo 125' Roll, Black	1006766	\$99.99 pkg.
Jumbo 125' Roll, Biege	1006761	\$99.99 pkg.

C. KT Tape Original

Designed with cotton microfibers, KT Tape can be comfortably worn for 1–3 days at a time. It is an ideal solution for lighter workouts and activity.

20 Pre-Cut 10" Strips, Beige	1006366	\$14.99 pkg.
20 Pre-Cut 10" Strips, Black	1006367	\$14.99 pkg.
16' Roll, Beige	1006361	\$14.99 pkg.
16' Roll, Black	1006360	\$14.99 pkg.
Pre-Cut 10", Jumbo 150 Roll, Beige.....	1006763	\$66.99 pkg.
Jumbo 125' Roll, Beige	1006765	\$66.99 pkg.
Pre-Cut 10", Jumbo 150 Roll, Black.....	1006762	\$66.99 pkg.
Jumbo 125' Roll, Black	1006764	\$66.99 pkg.

D. KT Tape Jumbo Roll Tape Dispenser

A wire frame dispenser that holds up to four jumbo rolls of kinesiology tape for convenient access and portable storage for the busy athletic trainer.

.....	1006962	\$78.99 ea.
-------	----------------	-------------

Not made with Natural Rubber Latex.



A



C



D

**COMPARE TO
CRAMER AND
MUELLER**



B

A. Cramer® Skin-Lube®

2.75 oz. Tube.....	43087	\$6.15 ea.
1 lb.	43088	\$12.00 ea.
5 lbs.	43089	\$46.45 ea.
25 lbs.	43076	\$223.00 ea.

B. Econoline® Skin Lubricant

White petroleum jelly—economical for lubricating heel and lace pads.

1 lb.	43181	\$9.74 ea.
8 lbs.	43184	\$34.06 ea.
25 lbs.	43183	\$130.42 ea.

C. Mueller® Lubricating Ointment

Apply to skin to reduce friction from athletic equipment, pad, and shoes. Contains lanolin.

3 oz. Tube.	43218	\$7.31 ea.
1 lb.	43217	\$13.90 ea.
5 lbs.	43219	\$65.45 ea.

D. Mueller® Lube-In-A-Tube

No more tongue depressors and tubs-of-goo! Eliminates the futility associated with messy, wasteful and inconsistent lubricant application. Efficient, quick, and clean.

Starter Kit includes:

- (2) 9 oz. tubes of lubricating ointment
- (2) Adaptor tips
- (1) Applicator

Starter Kit	1006699	\$63.10 kit
Refill 12 Pack, 9 oz. Tubes	1006700	\$148.50 pkg.



A



B



C



D



E

A. Econoline® Heel & Lace Pads

Cushy foam padding for decreased shoe friction and increased comfort under athletic taping, 2,000 per case.

3" x 3" Heel & Lace Pads, Un-Lubricated	29145	\$37.99 cs.
3" x 3" Heel & Lace Pads, Pre-Lubricated.	28389	\$66.99 cs.
3" x 4" Heel & Lace Pads, Un-Lubricated ...	1006968	\$55.99 cs.
3" x 4" Heel & Lace Pads, Pre-Lubricated	1006969	\$78.99 cs.

B. Econoline® Eline Felt Heel & Lace Pads

2½" x 4" x ¼"		
100/bag	28234	\$42.99 bag

C. Econoline® Volara Foam Heel & Lace Pads

Padded heel and lace pads with adhesive.

Packaged 4/sheet, 250 sheets/pkg.

1,000/pkg	28079	\$119.99 pkg.
-----------------	--------------	---------------

D. Mueller® Heel & Lace Pads

3" x 3" x ¼", 2,000/box.....	28124	\$39.99 box
3" x 4" x ¼", 1,000/box.....	28082	\$69.99 box

E. Cramer® Heel & Lace Pads

3" x 3" x ¼", 2,000/box.....	28123	\$34.99 box
------------------------------	--------------	-------------

Taping Accessories



A. Cramer® Tuf-Skin®

Helps secure tape, underwrap, and elastic wraps. Reduces friction.

Colorless

4 oz.....	50019	\$7.29 ea.
6 oz.....	50098	\$12.35 ea.
10 oz.....	50020	\$14.60 ea.
Original		
8 oz.....	50097	\$13.10 ea.

B. Cramer® Q.D.A.

A light, quick-drying adherent to help secure tape, underwrap, and elastic wraps. Reduces blister-causing friction. Colorless.

8 oz.....	50018	\$13.70 ea.
-----------	--------------	-------------

C. Cramer® Tape Remover

Fast-acting tape remover deactivates tape adherent, rather than dissolving it.

16 oz., Liquid.....	34100	\$15.95 ea.
---------------------	--------------	-------------

D. Mueller® Tuffner® Pre-Tape Spray

Spray adherent helps secure tapes and wraps. Clear.

4 oz.....	50106	\$7.99 ea.
10 oz.....	50105	\$9.99 ea.
8 oz. Pump Spray . . .	34298	\$9.99 ea.

E. Mueller® Tuffner® Tape and Tuffner® Remover

New citrus scented formula. Removes toughener sprays, ointments, liniments, rubs, and adhesive particles from skin.

4 oz., Spray	50214	\$6.99 ea.
9 oz., Spray	50215	\$10.99 ea.
1 qt., Liquid	34254	\$18.99 ea.
Gallon Liquid	34253	\$41.99 ea.

F. Medi-Sol® Adhesive Remover

Safely and effectively removes all types of adhesive from skin and equipment. Nontoxic, non-carcinogenic, and without harsh solvents.

Wipes, 50/box	49036	\$14.60 box
4 oz., Liquid	34207	\$13.35 ea.

G. Adhesive Tape Remover Pads

100/box	49006	\$7.27 box
-------------------	--------------	------------

H. Stik It™ Ampoules

Skin adherent that comes in disposable ampoules. Positive adhesion forms a colorless bond. Built-in applicator swab, non-irritating, protects the skin and helps with easy tape removal.

100/box	49113	\$191.00 box
-------------------	--------------	--------------

I. Benzoïn Tincture Ampoules

Can be used to adhere to athletic tape and bandages. May also be applied as an antiseptic to small cuts and to skin as a protective dressing under protective bandages.

100/box	49061	\$46.55 box
-------------------	--------------	-------------

J. Mastisol®

A non-irritating, hypoallergenic, liquid medical adhesive that will secure the most difficult of dressings for a prolonged period of time. Stickier than compound tincture of benzoïn.

Sterile Vial, ½ mL,		
48/box	34127	\$182.99 box
Unit Dose,		
15 mL Bottle	34128	\$23.99 ea.
Dispenser,		
2 oz. Bottle	34129	\$60.99 ea.

K. Taping Block

When taping tables are not available, this plastic molded wedge makes taping easier.

Black	90051	\$16.99 ea.
-----------------	--------------	-------------

Tubular Compression Bandages & Elastic Wraps



Cramer® Compressionette

Tubular bandage is elasticized to offer mild support and minimize swelling. Can hold hot/cold packs in place. Reusable and washable.

Black		
3" x 11 yds.	91064	\$58.99 ea.
White		
3" x 11 yds.	41053	\$57.99 ea.
5" x 11 yds.	41054	\$78.99 ea.



HARTMANN Comperm® LF Tubular Elastic Bandage

Provides 360° of compression and support with minimal constriction. For edema reduction, post-cast support, dressing coverage, post-burn scarring, sprains, strains, and soft-tissue injuries. No clips or tape.

Size A, Very Small Limbs or Feet		
1 5/8" x 11 yds.	31023	\$39.99 ea.
Size B, Small Limbs		
2 1/2" x 11 yds.	31024	\$51.99 ea.
Size C, Hands, Feet or Small Lower Legs		
2 3/4" x 11 yds.	31025	\$55.99 ea.
Size D, Lower Legs or Arms		
3" x 11 yds.	31026	\$62.99 ea.
Size E, Knees or Small Thighs		
3 1/2" x 11 yds.	31027	\$69.99 ea.
Size F, Large Knees or Thighs		
4" x 11 yds.	31028	\$74.99 ea.
Size G, Large Thighs		
5" x 11 yds.	31029	\$89.99 ea.
Size J, Small Trunk		
7" x 11 yds.	31063	\$99.99 ea.
Size K, Medium Trunk		
8 1/2" x 11 yds.	31064	\$94.99 ea.



School Health Brand Elastic Bandages

School Health Brand Elastic Bandages offer high quality and consistent support. These bandages are great for securing cold packs, splints, and dressings. School Health Brand Elastic Bandages are a premier solution at an economy price. Be prepared to address the needs of your students or athletes and their injuries. Packaged in cellophane.

Elastic Bandage with Clips

	1-11 Rolls		Box of 12
2" x 5" yds.	31006	\$0.92 roll	31123 \$7.76 box
3" x 5" yds.	31007	\$1.18 roll	31124 \$8.91 box
4" x 5" yds.	31008	\$1.64 roll	31126 \$13.75 box
6" x 5" yds.	31009	\$2.56 roll	31127 \$19.75 box
4" x 10" yds.	31073	\$3.03 roll	31128 \$25.00 box
6" x 10" yds.	31075	\$4.34 roll	31129 \$32.30 box

Buy a case and SAVE!

Elastic Bandage with Hook and Loop Closures

	1-11 Rolls		Box of 12
2" x 5" yds.	31059	\$1.40 roll	31130 \$10.70 box
3" x 5" yds.	31060	\$2.05 roll	31131 \$17.45 box
4" x 5" yds.	31061	\$2.32 roll	31132 \$20.45 box
6" x 5" yds.	31062	\$2.99 roll	31133 \$31.55 box
4" x 10" yds.	31076	\$6.11 roll	31134 \$57.70 box
6" x 10" yds.	31077	\$8.07 roll	31135 \$75.85 box

Buy a case and SAVE!

Not made with Natural Rubber Latex.

Elastic Wrap



Supreme Premium Orthopedic Bandages

The Supreme is the ideal compression bandage and used widely in orthopedics and sports medicine.

2" x 5 yds.....	.31136	\$2.49 ea.
3" x 5 yds.....	.31137	\$2.99 ea.
4" x 5 yds.....	.31138	\$3.49 ea.
6" x 5 yds.....	.31139	\$5.99 ea.
4" x 10 yds.31140	\$6.99 ea.
6" x 10 yds.31141	\$9.99 ea.

Midlastic Mid-Range Elastic Bandages

The Midlastic Elastic Bandage is an excellent quality, mid-range elastic bandage that provides consistent support.

2" x 5 yds.....	.31148	\$1.49 ea.
3" x 5 yds.....	.31149	\$2.49 ea.
4" x 5 yds.....	.31158	\$2.99 ea.
6" x 5 yds.....	.31150	\$4.49 ea.

Valuelastic Economy Elastic Bandages

The Valuelastic is a lightweight general use elastic support bandage. High quality, reinforced woven yarns provide balanced stretch and compression.

2" x 5 yds.....	.31142	\$1.49 ea.
3" x 5 yds.....	.31143	\$1.49 ea.
4" x 5 yds.....	.31144	\$1.99 ea.
6" x 5 yds.....	.31145	\$2.99 ea.
4" x 10 yds.31146	\$3.38 ea.
6" x 10 yds.31147	\$4.99 ea.

Supra-Grip Double Velcro Self Closure Elastic Bandage

The Supra-Grip bandages offer non-slip compression and support without the need for pins, clips, or tape.

3" x 5 yds.....	.31152	\$2.49 ea.
4" x 5½ yds.....	.31153	\$2.99 ea.
6" x 5½ yds.....	.31155	\$3.99 ea.
4" x 11 yds.31156	\$6.99 ea.
6" x 11 yds.31157	\$8.99 ea.



A. HARTMANN Deluxe® LF Elastic Bandages

High cotton content, orthopedic grade bandages provide superior compression and support. Ideal for sensitive skin. Clip fasteners included.

2" x 5½ yds.....	.31017	\$4.99 roll
3" x 5½ yds.....	.31018	\$5.99 roll
4" x 5½ yds.....	.31019	\$6.99 roll
6" x 5½ yds.....	.31020	\$8.99 roll
4" x 11 yds. (Double Length)	.31040	\$17.99 roll
6" x 11 yds. (Double Length)	.31041	\$26.99 roll

B. HARTMANN Context LF Premium Grade Elastic Bandages

Washable. Clip fasteners included.

2" x 5 yds.....	.31078	\$1.99 roll
3" x 5 yds.....	.31079	\$1.99 roll
4" x 5 yds.....	.31080	\$2.99 roll
6" x 5 yds.....	.31081	\$3.99 roll

C. HARTMANN Deluxe® 480 LF

Orthopedic grade woven bandage. Cotton blend fabric provides superior strength and consistent elasticity, support, and compression.

2" x 5 yds.....	.31118	\$3.99 roll
3" x 5 yds.31119	\$4.99 roll
4" x 5 yds.31120	\$5.99 roll
6" x 5 yds.31121	\$8.99 roll

D. HARTMANN Shur-Band® LF

No clips. Washable. Velcro fastener.

2" x 5 yds.....	.31010	\$2.99 roll
3" x 5 yds.....	.31011	\$3.99 roll
4" x 5 yds.....	.31012	\$3.99 roll
6" x 5 yds.....	.31013	\$4.99 roll
4" x 10 yds. (Double Length)	.31066	\$9.99 roll
6" x 10 yds. (Double Length)	.31065	\$12.99 roll

Not made with Natural Rubber Latex.

Braces & Protective Equipment



Foot Ankle	26	Thumb & Fingers	42-43
Ankle Support	27-32	Elbow	44-45
Calf & Shin	33	Shoulder	46-47
Knee	34-39	Torso & Back	48
Thigh & Hip	39-40	Facemasks	49
Wrist	41-42	Mouthguards	50

Foot Ankle



A



B



C



D



A. Mueller® ATF® 3 Ankle Brace

Inversion sprains (rolled ankle) account for approximately 85% of all ankle sprains. ATF®3 Ankle Brace features a patented internal strapping system that self-adjusts to support your Anterior Talofibular Ligament. This system helps protect against 'rolling the ankle' without restricting jumping, speed, or agility.

Sold by Shoe Size			
Size	Men's	Women's	Black
X-Small	6-7	7-8	1031601
Small	7-9	8-10	1031602
Medium	9-11	10-12	1031603
Large	11-13	12-14	1031604
X-Large	13-15	14-16	1031605
XX-Large	15-17	16-18	1031606
All Sizes.....	\$25.99 ea.		

B. Mueller® Soft Ankle Brace with Strap

Constructed out of durable denier 1,000 polyester which allows for a lightweight brace. The low-profile design can be used on either ankle for effective ankle stabilization. Designed for rehabilitation or general sports protection. Figure eight locking straps prevent rollover and keep your ankle locked in a neutral position.

- Padded tongue for enhanced comfort
- Lace up provides a customized fit
- Low-profile design provides comfort and protection at the same time

Sold by Shoe Size			
Size	Men's	Women's	Item #
X-Small	6-7	7-8	63849
Small	7-9	8-10	63850
Medium	9-11	10-12	63851
Large	11-13	12-14	63852
X-Large	13-15	14-16	63853
All Sizes.....	\$22.99 ea.		

C. Mueller® The ONE® Ankle Brace Premium

With its improved fit and slender profile, The ONE Ankle Brace Premium feels like having your ankle professionally taped by an athletic trainer. It's a reliable way to help prevent common ankle injuries when you're playing, including ankle strains. Measurements based on shoe size.

The ONE Ankle Brace is also great for rehabbing inversion ankle sprains and eversion ankle sprains off the court. The secure fit helps support your ankle by slightly restricting awkward and irregular movements to encourage healing.

Sold by Shoe Size			
Size	Men's	Women's	Black
X-Small	6-7	7-8	1031607
Small	7-9	8-10	1031608
Medium	9-11	10-12	1031609
Large	11-13	12-14	1031610
X-Large	13-15	14-16	1031611
2X-Large	15-17	16-18	1031612
3X-Large	17-19	18-20	1031613
All Sizes.....	\$41.99 ea.		

D. Mueller® Hg80® Ankle Brace with Straps

- Straps provide exceptional support via a heel-lock and figure-eight configuration
- Composed of moisture-wicking fabric, which is neoprene-free
- Antimicrobial barrier provides protection against odor-causing bacteria
- Lightweight, extremely soft to the touch and comfortable
- Includes free nylon mesh laundry bag

Sold by Shoe Size			
Size	Men's	Women's	Item #
Medium	9-11	10-12	41407
Large	11-13	12-14	41408
X-Large	13-15	14-16	41409
All Sizes.....	\$38.99 ea.		

Cramer® Active Ankle AS1 Pro

The Active Ankle AS1 Pro is designed for athletes who prefer the comfort and mobility of a lace up, but desire the added support and security of a “tape-job”.

Sold by Shoe Size			
Size	Men's	Women's	Black
X-Small	6-7	7-8	65118
Small	8-9	9-10	65119
Medium	10-11	11-12	65120
Large	12-13	13-14	65121
X-Large	14-15	15-16	65122
2X-Large	15+	16+	65123
All Sizes.....			\$40.99 ea.



McDavid® 195 Level III Ankle Brace with Straps

The 195 features an ultra-light nylon shell with fully adjustable, figure-eight straps to simulate athletic tape. Straps can be tightened without re-lacing the brace. For support and comfort it includes a padded lining, notched front, elastic heel and tongue, and a sewn-in arch support.

Sold by Shoe Size				
Size	Men's	Women's	Black	Gray
X-Small	6-7	7-8	41496	1003568
Small	8-9	9-10	41497	1003566
Medium	9-11	11-12	41498	1003565
Large	12-13	12-14	41499	1003564
X-Large	14+	15+	41500	1003567
All Sizes.....			\$41.99 ea.	



McDavid® Bio-Logix Ankle Brace

The Bio-Logix philosophy demands a hybrid of rigid and flexible materials and rigid adherence to flexible anatomical integration throughout. 3D contouring alignment pocket with overlapping integrated stirrup support articulates to the shape of the foot. Easy rear opening with forefoot sleeve and quick-wrap closure provide exceptional ease of use and personalized fit.

- Low profile, lightweight, and highly-supportive brace
- Flex-Link hinge design for maximum ankle support and performance
- Quick-wrap closure secures ankle easily
- Simple on/simple off rear access with forefoot sleeve and quick-wrap closure
- Anti-slip silicone sole creates stable in-shoe contact and enhanced performance

Sold by Shoe Size				
Size	Men's	Women's	Left	Right
Small	7-8½	8-9½	1007399	1007400
Medium	8-11	9-12	1007401	1007402
Large	11+	12+	1007403	1007404
All Sizes.....			\$74.99 ea.	



Ankle Support



A. Aryse IFAST Ankle Brace

The IFAST is a patent-pending, revolutionary ankle brace that encourages elevated performance while limiting fear of injury. Created with functional stability, the IFAST provides custom, dynamic support for hardcourt athletes pre- or post-injury. Unlike traditional bracing, the IFAST is designed with superior materials that foster the body's organic movement. The IFAST transitions with the athlete from the beginning of practice to the end of competition without wearing down when support is needed the most.

- Mimics the body's natural movement
- Provides functional stability

Shop by Shoe Size			
	Men's	Women's	Item #
X-Small	Up to 7	Up to 8.5	1035311
Small	7.5-9	9-10.5	1035312
Medium	9.5-11	11-12.5	1035313
Large	11.5-13	13-14.5	1035314
X-Large	13.5-15	15-16.5	1035318
All Sizes.....			\$49.00 ea.

B. Aryse XFAST Ankle Brace

The XFAST is an ingenious, patent-pending solution to ankle bracing in cleated competition. Unlike conventional bracing that requires the athlete to force a restricting brace into an already narrow shoe, the XFAST supports from the outside of the shoe. This strategic placement converts the entire cleat into a stabilizing device for the athlete's ankle joint. The revolutionary design mimics the natural movement of the body and allows pre- or post-injury athletes to have a custom level of support at their end range of motion without interfering with the comfort of the shoe. Athletes have found the result to be enhanced comfort, prolonged protection, and elevated performance.

Shop by Shoe Size			
	Men's	Women's	Item #
X-Small	Up to 6.5	Up to 8	1035317
Small	7-8.5	8.5-10	1035318
Medium	9-10.5	10.5-12	1035319
Large	11-12.5	12.5-14	1035320
X-Large	13-14.5	14.5-16	1035321
All Sizes.....			\$49.00 ea.



C. ASO® EVO

The ASO EVO ankle stabilizer is an innovative approach to ankle protection. Its unique, stabilizing straps and cuffs incorporate the three main elements of an ankle taping application: stirrups, heel lock (figure eight), and circumferential closure. This new design provides exceptional ankle support and stability in the treatment of ankle injuries and reduces the severity and frequency of future injuries.

Measure ankle circumference to determine size.			
Size		Black	White
X-Small	10"-11"	41982	41988
Small	11"-12"	41983	41989
Medium	12"-13"	41984	41990
Large	13"-14"	41985	41991
X-Large	14"-15"	41986	41992
2X-Large	15"-16"	41987	41993
All Sizes, Colors.....			\$45.99 ea.

D. ASO® Ankle Stabilizing Orthosis

Elastic cuff closure decreases the amount of possible inversion. Ballistic nylon, figure-eight straps replicate ankle taping. Low-profile design will fit in any type of shoe. Lace-up closure. Bilateral stability helps keep foot in neutral position.

Measure ankle circumference around the heel.			
Size		Black	White
X-Small	10"-11"	41682	41688
Small	11"-12"	41683	41689
Medium	12"-13"	41684	41690
Large	13"-14"	41685	41691
X-Large	14"-15"	41686	41692
2X-Large	15"-16"	41687	41693
All Sizes, Colors.....			\$39.99 ea.

Ultra CTS® Ankle Brace

Treat and rehabilitate acute ankle injuries with Ultra's proprietary Custom Treatment System (CTS). The snap-in PerformaFit® upright provides maximum lower leg compression, and stabilization for acute injury treatment. Or snap it out for low profile, active rehabilitation. It's total ankle injury management in one ankle brace.

- Advanced hinged-cuff design restricts excessive inversion, eversion and rotation
- Total ankle injury management in one ankle brace
- Fits right or left ankle
- Acute injury treatment, active rehabilitation

Sold by Shoe Size			
Size	Men's	Women's	Item #
Small/Medium	6-10	7-11	55937
Large/X-Large	10 and up	11 and up	55634
All Sizes.....			\$161.99 ea.



Ultra High-5® Ankle Brace

- Fits either ankle, 38% lighter weight
- Quickly treat any ankle injury, including high ankle sprains
- Semi-rigid, form-fitting shell adjusts to your ankle for comfortable, secure fit
- Anti-inversion, anti-rotation stability

Sold by Shoe Size			
Size	Men's	Women's	Item #
Small	5-9	6-10	63326
Medium	10½-13	10½-13	63327
Large	12½ +	13½ +	63328
All Sizes.....			\$75.99 ea.



Ultra Zoom® Ankle Brace

- Multi-patented Performathane® soft shell technology for athletes who require a super-low profile performance ankle brace
- Full season warranty
- Fits either ankle
- Soft shell "forms" to ankle

Sold by Shoe Size			
Size	Men's	Women's	Item #
Small/Medium	6-10	7-11	63329
Large/X-Large	10 and up	11 and up	63330
All Sizes.....			\$63.99 ea.



Ankle Support



Mueller® Hg80® Support Sleeves

Made with a unique moisture management system that provides lightweight, breathable support for peak performance and recovery.

The Hg80 sleeves are made of smooth, comfortable materials that offer soothing compression and key support points with a gel buttress.

- Designed to help relieve pain associated with arthritis and tendonitis
- Aegis Microbe Shield Technology protects against microbial growth; controls or eliminates odors, stains, and deterioration of the support
- Conforms to the body in motion

Sold by Shoe Size			
Shoe Size	Men's	Women's	Item #
X-Small	6-7	7-8	63828
Small	7-9	8-10	63829
Medium	9-11	10-12	63830
Large	11-13	12-14	63831
X-Large	13-15	14-16	63832
All Sizes, Black			\$18.99 ea.



T-2 Active Ankle® Brace

Features a single, quick-fastening strap that adjusts for high- and low-top shoes. A new, feather-light EVA padding system conforms to the ankle, providing high comfort without bulk.

Sold by Shoe Size				
Size	Men's	Women's	Black	White
Small	5-8½	6½-9½	41350	41342
Medium	9-12	10-13	41351	41343
Large	12½-16	13½-16	41352	41344
All Sizes, Colors			\$44.99 ea.	



FS6 Compression Foot Sleeve

The FS6 Compression Foot Sleeve is effective at relieving the pain of plantar fasciitis, chronic arch and heel pain, and swelling in the foot. Patent pending Compression Zone Technology wraps the foot in thin, comfortable, moisture-wicking fabric that supplies medical grade orthopedic support and all the benefits of graduated compression.

Sold by Shoe Size			
Size	Men's	Women's	Item #
Small	3-5.5	4-6.5	1003498
Medium	6-9	7-10.5	1003499
Large	10-13	11+	1003500
X-Large	13.5+	-	1003501
All Sizes			\$49.99 ea.



DonJoy Performance Trizone Ankle Sleeve

The DonJoy Performance Trizone Ankle Sleeve is a hybrid design combining the properties of compression and bracing in a single sleeve. The carbonized bamboo, circular knit construction allows for targeted, zonal compression with thermal regulating properties. The Trizone ankle support is a low-profile performance product designed to increase ankle stability, plantar fascia support, and decrease swelling and inflammation, while fitting comfortably in any shoe without compromising fit and function.

Measure ankle circumference around the heel.		
Size		Item #
Small	7½"-8½"	1031955
Medium	8½"-9½"	1031956
Large	9½"-10½"	1031957
X-Large	10½"-11½"	1031958
All Sizes		\$51.99 ea.

Donjoy POD Ankle Brace

The POD Ankle Brace's patent-pending technology provides ankle bracing, eliminating the need for ankle tape. The unique design maintains natural motion and freedom of movement during activity, while helping prevent ankle roll and other common ankle injuries. Combining this with lightweight construction and comfort gives athletes of all levels confidence in prevention and performance.



Sold by Shoe Size				
Size	Men's	Women's	Left	Right
X-Small	4½-7½	6½-8½	1031965	1031966
Small	6½-9½	7½-10½	1031963	1031964
Medium	9-12½	10 +	1031961	1031962
Large	12½-15	-	1031959	1031960
All Sizes.....			\$62.99 ea.	

Aircast® Air-Stirrup Ankle Brace

Fits comfortably in the shoe. Pre-inflated, adjustable air cells conform and compress swollen tissue. When worn with a laced shoe, the brace limits inversion/eversion, but permits dorsi and plantar flexion. Training brace is for chronic instability and prophylactic athletic support. Small brace is for acute and chronic injuries in patients 5'2" and smaller.

Standard Model, Right41243	\$59.99 ea.
Standard Model, Left41244	\$59.99 ea.
Training Brace, Right41245	\$59.99 ea.
Training Brace, Left41246	\$59.99 ea.
Small Brace, Right41247	\$59.99 ea.
Small Brace, Left41248	\$59.99 ea.



Aircast® Sport-Stirrup Prophylactic Brace

Similar to the Training brace, but narrower for less bulk in a regular or high-top athletic shoe.

Right41368	\$52.99 ea.
Left41369	\$52.99 ea.

Aircast® Leg Brace

Supports, compresses, and protects the lower leg and ankle within the regular shoe. Standard leg brace is 15½" long; small leg brace is 13" long.

Right41364	\$85.99 ea.
Left41365	\$85.99 ea.
Small, Right41366	\$85.99 ea.
Small, Left41367	\$85.99 ea.

Aircast® Air-Stirrup® Universal™ Care Kit

Complete system for the functional management of an ankle sprain. Includes an Air-Stirrup Universe Ankle Brace, ankle wrap, cold pack, exercise band, plus a DVD booklet showing instructions for treatment and rehabilitation.

.....	.63190	\$44.99 kit
-------	--------	-------------



Ankle Support



Procare™ Pro Step® Walker

Lightweight, sturdy, one-piece design with integrated strapping provides full circumferential compression. The non-skid sole is a rocker and the fiber leg wrap is washable. Open heel.

Sold by Shoe Size			
Size	Men's	Women's	Item #
Small	3-7	4-8	41632
Medium	7-10	8-11	41633
Large	10-13	11-14	41634
All Sizes.....			\$51.99 ea.



Cramer Dorsal Night Splint

Designed to comfortably hold the foot in a neutral position during sleep, thereby helping to alleviate morning pain and discomfort. It may also be used to stabilize the ankle in a neutral position. Strong, durable clamshell with a triple stitched stretch resistant strap provides exceptional support.

Small, Shoe Sizes 5-10	41547	\$68.99 ea.
Large, Shoe Sizes 10½-16	41548	\$68.99 ea.



Pro-Tec® Athletics Soft Night Splint

Features:

- Alleviates pain and tightness in arch and Achilles tendon
- Combines the benefits of a compression sock with the stability of a traditional night splint
- Breathable compression provides stimulating massage to calf and Achilles tendon
- Firm insole offers stability to hold foot in place throughout stretching period
- Toe wedge supports toes in comfortable dorsiflexion

Sold by Shoe Size			
Size	Men's	Women's	Item #
Small	5-8	6-8	20296
Medium	8.5-11	8.5-10.5	20297
Large	11.5-13.5	11-13	20298
All Sizes.....			\$32.99 ea.



A. McDavid® 441 Level I Calf Sleeve

Provides warmth, compression and support for muscle strains, and shin splints. Reversible thermal neoprene support with nylon facing on both sides (heavy duty nylon on outer side for durability).

Measure around the largest part of calf		
Size		Black
Small	12"-14"	41022
Medium	14"-15"	41023
Large	15"-17"	41024
X-Large	17"-18"	41025
All Sizes. \$19.99 ea.		

B. McDavid® 8836 mmHg Calf Sleeve

- Calves benefit from increased blood circulation
- Quick-drying and antimicrobial
- Moisture Management Technology

Measure around the largest part of calf		
Size		Black
Small	12.5"-13"	65092
Medium	13"-14"	65093
Large	15"-16"	65094
X-Large	16"-17"	65095
2X-Large	17"-17.5"	65096
All Sizes. \$30.99 ea.		

C. Pro-Tec® Shin Splint Compression Wrap

Contoured neoprene wrap provides targeted compression to stabilize soft tissue. Wrap helps keep soft tissue against tibia to reduce further tearing and inflammation associated with shin splints. Easy on/off application.

One Size. 41788 \$27.99 ea.

D. McDavid 4102 Runner's Therapy Shin Splint Sleeve

Level 2 advanced protection. Therapeutic relief from moderate shin splint pain with increased muscle support.

- Dual compression anatomical design for enhanced pain relief and support
- Contoured support pads targeted to shin provides healing pressure (two pads—adjustable/removable)
- Ergonomic, lightweight design for all-workout comfort and fit
- Moisture-wicking, breathable fabric with four-way stretch

Measure around the largest part of calf		
Size		Black
Small	12"-14"	1007395
Medium	14"-15"	1007396
Large	15"-17"	1007397
X-Large	17"-18"	1007398
All Sizes. \$40.99 ea.		

E. DonJoy Performance Trizone Calf Sleeve

The DonJoy Performance Trizone Calf Sleeve is a hybrid design combining the properties of compression and bracing in a single sleeve. This product takes the benefits of bracing and applies it to a muscle. The carbonized bamboo, circular knit construction allows for targeted, zonal compression with thermal regulating properties. The Trizone calf support is a low-profile performance product perfect for runners looking to add miles and decrease recovery times.

Measure around the largest part of calf		
Size		Black
Small	11"-13"	1031984
Medium	13"-15"	1031983
Large	15"-17"	1031982
X-Large	17"-19"	1031985
All Sizes. \$51.99 ea.		

Knee



DonJoy Trizone Knee Sleeve

The properties of compression and bracing in a single sleeve. Designed to keep you moving through repetitive motion injuries including strains, inflammation, and swelling, tendonitis and soreness.

Features:

- Anti-Migration
- Naturally Anti-Bacterial Bamboo
- Zoned Compression
- Silicone Banded Support
- Lightweight
- Ergonomic
- Thermal Regulation
- Reflective

Size	Left	Right
X-Small	1035235	1035228
Small	1035236	1035229
Medium	1035237	1035230
Large	1035238	1035231
X-Large	1035239	1035232
2X-Large	1035240	1035233
3X-Large	1035241	1035234
All Sizes.....	\$87.99 ea.	



Mueller® Hg80® Premium Hinged Knee Brace

Made with improved, exclusive, high-performance, moisture wicking material with an antimicrobial barrier.

Features:

- Patented Triaxial Hinge tracks the knee motion and allows maximum mobility
- Upper strapping locks brace in position
- Comfortable, breathable stretch panel behind the center of the knee
- Lightweight materials with reflective binding
- Upper bidirectional stretch material is form fitting and fully adjustable

Measure around knee		
Size	Black	
Small	12"-14"	1032124
Medium	14"-16"	1032125
Large	16"-18"	1032126
X-Large	18"-20"	1032127
2X-Large	20"-22"	1032128
All Sizes.....	\$91.99 ea.	



Mueller® Hg80® Premium Knee Brace

Made with improved, exclusive, high-performance, moisture wicking material with an antimicrobial barrier.

Features:

- Supportive steel springs support both sides of the knee
- New and improved lightweight materials with reflective binding
- Comfortable, breathable stretch panel behind the center of the knee

Measure around knee		
Size	Black	
Small	12"-14"	1032074
Medium	14"-16"	1032129
Large	16"-18"	1032130
X-Large	18"-20"	1032131
2X-Large	20"-22"	1032132
All Sizes.....	\$79.99 ea.	

 Not made with Natural Rubber Latex.

McDavid® Bio-Logix Knee Brace with Compression Knee Sleeve

This is a combo of high-end rigid materials and advanced softer materials to create total, precision support and Body-In-Motion flex. The C-Frame bring the medial and the lateral hinges into anatomic harmony to literally work together. With a color-coded, Anti-Migration Strap System, you get seriously great self-adaptive fitting and supportive tie-in throughout the molded structures. Underneath it all is the Sleeve-Lock. In addition, the Sleeve is built to fold up, down, and ultimately over the brace to streamline and secure the entire deal. Includes brace and sleeve.

Measure around knee			
Size		Left	Right
Medium	14"-15"	1007405	1007417
Large	15"-17"	1007418	1007406
All Sizes.....		\$171.99 ea.	



A. McDavid® 425 Level II Knee Support with Straps

Long sleeve, 3/16" thick, superior horseshoe buttress with two medial and two lateral stays, and two Velcro® straps. Four additional crossing straps lend minor support to ligaments.

Measure around mid-knee		
Size		Black
Small	12"-14"	41102
Medium	14"-15"	41103
Large	15"-17"	41119
X-Large	17"-20"	41120
2X-Large	20"-22"	41838
All Sizes.....		\$51.99 ea.

B. McDavid® 422 Level III Dual Disk Hinged Knee Brace

Features two wider, more stable hinges than standard knee braces and incorporates a dual disk hinge with a floating pivot point to accommodate the natural gliding action of the knee. Includes a long, 3/16" thick neoprene sleeve with nylon facing on both sides and a seamless, breathable, perforated neoprene back panel for improved comfort.

Measure around knee		
Size		Black
Small	12"-14"	63178
Medium	14"-15"	63179
Large	15"-17"	63180
X-Large	17"-20"	63181
2X-Large	20"-22"	63182
All Sizes.....		\$61.99 ea.

C. Shock Doctor® 875 Ultra Knee Support

Features bilateral support hinges and tempered aluminum stays for knee stability, protection, and performance. The stitching assembly, patella support finishing, and Lycra binding are built for rigorous activities and lasting comfort. Finger tabs offer easy grip when putting on.

Measure around mid-knee		
Size		Black
Small	17.75"-19"	1006318
Medium	18.75"-20.25"	1006319
Large	20"-22.5"	1006320
X-Large	20"-21.25"	1006321
2X-Large	22.25"-23.5"	1006322
All Sizes.....		\$77.99 ea.



D. Donjoy® Bionic Fullstop

As part of our stable line of sport performance bracing products, the Bionic Fullstop provides Anterior Cruciate Ligament (ACL) protection during recovery from injury, as well as prevention of future injury. Fullstop dampening hinges prevent hyperextension and help improve joint mechanics in both surgical and non-surgical knees.

Measure around mid-knee		
Size		Black
Small	13"-14"	1031979
Large	15"-17"	1031980
X-Large	17"-19"	1031981
All Sizes.....		\$264.99 ea.



Knee



A. DonJoy® Playmaker®

DonJoy's premier soft knee ligament brace. Recommended for sports and activities of daily living. Suitable for mild-to-moderate ligament instabilities. Ideal intermediate-level product for sports.

- Cool and breathable Drytex® construction
- Sleeve/wrap for optimal fit and comfort
- Popliteal cutout for improved fit and comfort
- Versatile strapping for combined instability configurations

Measure 6" above mid-patella			
	Size	Wrap	Sleeve
Small	15½"-18½"	63734	63730
Medium	18½"-21"	63735	63731
Large	21"-23½"	63737	63732
X-Large	23½"-26½"	63738	63733
All Sizes..... \$266.99 ea.			

B. DonJoy® Performance Bionic Knee Brace

The DonJoy Performance Bionic Knee Brace features support and protection from lateral forces that occur in everyday sports and activities. The Hex-shaped patella opening provides patella support and stability while articulating more freely as the knee goes through flexion and extension. Asymmetrical hem lines and stretch webbing closure system ensure the proper fit for comfort and controllable compression. The wrap-around design of this knee brace allows for quick, easy on/off without the need to remove shoes.

Measure around knee		
	Size	Black
Small	13"-14"	1031977
Medium	14"-15"	1031976
Large	15"-17"	1031975
X-Large	17"-19"	1031978
All Sizes.....\$88.99 ea.		

C. DonJoy® Hinged Knee

The encased polycentric hinge with aluminum uprights in this low-profile wrap/sleeve provides mild to moderate medial/lateral support.

- Cool and breathable Drytex® construction
- Sleeve or wrap for optimal fit and comfort
- Popliteal and patella cutouts for improved fit and comfort

Measure 6" above mid-patella			
	Size	Wrap	Sleeve
Small	15½"-18½"	63721	63725
Medium	18½"-21"	63722	63726
Large	21"-23½"	63723	63727
X-Large	23½"-26½"	63724	63728
All Sizes..... \$133.99 ea.			

D. DonJoy Webtech Knee Brace

Features an innovative, three-part system that is ideal for helping to relieve common forms of knee pain often associated with sports injuries, overuse injuries, and degenerative conditions. Patented silicone web technology works to suspend, align, and cushion the knee joint structure, an ergonomic compression molded back pad adjusts easily to optimize fit and comfort, and a four-way stretch lycra/mesh undersleeve eliminates hot spots and provides an added layer of protection.

Measure around mid-knee		
	Size	Black
Small	13"-14"	1031971
Medium	14"-15"	1031970
Large	15"-17"	1031969
X-Large	17"-19"	1031972
All Sizes..... \$104.99 ea.		

E. DonJoy® Reaction Knee Brace

Elastomeric web design creates energy dispersion across the knee for shock absorption, shifting the peak loads away from the painful area of the knee, which helps reduce pain during daily activities. Elastomeric web and mesh backing create a very comfortable and breathable solution for anterior knee pain, chondromalacia, quadriceps and patella tendonitis, Osgood-Schlatter disease, and general patellofemoral tracking issues.

Measure 6" above mid-patella		
	Size	Black
Small	15½"-18½"	63747
Medium	18½"-23"	63748
X-Large	23½"-26½"	63750
All Sizes..... \$108.99 ea.		

F. Mueller® Pro Level™ Hinged Knee Brace

Designed for the serious athlete, this high-performance brace is ideal for weak or injured knees needing maximum medial/lateral support, without restricting mobility. The patented triaxial hinge properly tracks the knee joint and produces near-normal joint motion of the knee, allowing you to uninhibitedly perform at your peak.

Measure 7" above and 7" below center of knee				
	Size	Thigh	Calf	Black
Small	17"-18"	13"-14"		63286
Medium	19"-20"	14"-15"		63287
Large	21"-22"	15"-16"		63288
X-Large	23"-24"	16"-17"		63289
2X-Large	25"-26"	17"-18"		63290
3X-Large	27"-28"	18"-19"		63291
All Sizes.....\$70.99 ea.				



A



B



C



D

A. McDavid® Hex Leg Sleeve

Leg sleeves featuring 9 mm Hex™ Technology is a favorite among pro and collegiate players. Sold in pairs.

Measure around mid-knee			
Size		Black	White
Small	12"-14"	1003574	1005998
Medium	14"-15"	1003573	1005997
Large	15"-17"	1003572	1002596
X-Large	17"-20"	1003575	1005999
All Sizes/Colors \$43.99 pr.			

B. McDavid® 6440 HexPad® Knee/Elbow/Shin Pad

Features HexPad® in a protective pad for the knee, elbow, calf, shin, and/or arm. Individual hex-shaped pads conform to and move with your body for comfort and continuous protection. Compression fabric holds the pad in place and keeps muscles warm to prevent pulls and fatigue. HydraVent hDc™ Moisture Management Technology keeps athletes cool and dry.

Measure around specific body part		
Size		Black
Small	9"-12"	63159
Medium	12"-16"	63160
Large	16"-20"	63161
X-Large	20"-23"	63162
2X-Large	23"+	63163
All Sizes \$34.99 ea.		

C. LP Leg Compression Sleeve

The power system along the thigh, leg muscles, and knee joint enhances the lower extremity kinetic chain from the knee to the ankle, ensuring continuous movement stability and proprioception. It also increases the effectiveness of lower extremity movement reproduction.

Measure around mid-knee		
Size		Black
Small	13"-14¼"	1003493
Medium	14¼"-15¼"	1003494
Large	15¼"-17¼"	1003495
X-Large	17¼"-19"	1003496
XX-Large	19"-20½"	1003497
All Sizes \$36.99 ea.		

D. McDavid® 401 Level I Neoprene Support

Effective on a variety of problems, such as muscle strains, sprains, and hamstring pulls. Heavy duty outer nylon for longer life.

Measure around mid-knee		
Size		Black
Small	12"-14"	41129
Medium	14"-15"	41078
Large	15"-17"	41079
X-Large	17"-20"	41080
2X-Large	20"-22"	41835
All Sizes \$19.99 ea.		

Knee



A. School Health Brand Neoprene Knee Sleeve by Pro Orthopedic

Constructed of 1/8" thick neoprene with a nylon laminate on each side for durability, this sleeve features an anatomically conforming design with an open or closed patella. A full 10" in length.

Measure circumference around center of knee joint with leg extended and relaxed			
	Size	Open Patella	Closed Patella
X-Small	12 1/4"-13"	1002582	1002584
Small	13 1/4"-14"	1002581	1002583
Medium	14 1/4"-15"	63042	63038
Large	15 1/4"-17"	63043	63039
X-Large	17 1/4"-18"	63044	63040
2X-Lrg	18 1/4"-19"	63045	63041
All Sizes.....			\$13.99 ea.

B. McDavid® 419 Multi-Action Knee Strap

Features infinitely adjustable buttresses to customize the knee strap to your needs. The adjustable, two-way stretch neoprene wrap has hook-and-loop closures to provide optimum fit and comfort. Helps correct and relieve pain associated with jumper's or runner's knee and patella pain.

Small/Medium.....	63167	\$28.99 ea.
Large/X-Large.....	63168	\$28.99 ea.

FREE SHIPPING at SchoolHealth.com/SportsMed

Get FREE SHIPPING on your online order over \$100! Go to the back cover for Free Ship Online code. Can only be used once per customer. Expires 12-31-20.

C. Mueller® Breathable Knee Sleeves

Helps support sore, weak, injured, or arthritic knees and helps improve circulation to assist in healing and increased joint flexibility.

Features:

- Slide on/off design for easy fit with finger pulls for easy grip
- Contoured shape fits left or right knee
- Side air mesh panels for added breathability
- Extended length for a better fit

Measure circumference around center of knee joint with leg extended and relaxed			
	Size	Open Patella	Closed Patella
Small	13 1/4"-14"	1032120	1032108
Medium	14 1/4"-15"	1032121	1032109
Large	15 1/4"-17"	1032122	1032110
X-Large	17 1/4"-18"	1032123	1032111
2X-Large	18 1/4"-19"	-	1032112
All Sizes.....			\$25.99 ea.

D. Mueller® Knee Sleeves

Helps support sore, weak, injured, or arthritic knees and helps improve circulation to assist in healing and increased joint flexibility.

Features:

- Slide on/off design for easy fit
- Contoured shape fits left or right knee
- Standard patella opening
- Neoprene blend provides even compression and soothing warmth

Measure circumference around center of knee joint with leg extended and relaxed			
	Size	Open Patella	Closed Patella
Small	13 1/4"-14"	1032134	1032096
Medium	14 1/4"-15"	1032135	1032097
Large	15 1/4"-17"	1032136	1032098
X-Large	17 1/4"-18"	1032137	1023321
2X-Large	18 1/4"-19"	1032138	1032099
All Sizes.....			\$14.99 ea.

Not made with Natural Rubber Latex.



A



B



C



D



E



F



G

A. Mueller® Advanced Patella Knee Strap

This patella strap helps maintain kneecap alignment while walking, running, jumping, or climbing. The gentle compression helps relieve pain by absorbing high-impact shock.

The integrated bi-lateral strap connects directly to the buttress, so you can adjust the tension directionally (more or less on each side) for patella tracking issues. The Advanced Patella Strap can also be worn above the knee for IT Band (Iliotibial Band Syndrome) help.

Small/Medium.....	1031614	\$21.99 ea.
Large/X-Large.....	1031615	\$21.99 ea.

B. Mueller® Max Knee Strap

Patented strap gives an extra dimension of relief for painful and weakened knees. Allows full mobility. Fits left or right.

One Size Fits Most.....	.63082	\$21.99 ea.
-------------------------	---------------	-------------

C. McDavid® 414 Level II Jumper's Knee Strap

Features a tubular buttress in a neoprene strap with a Velcro® closure for graduated compression of the patellar tendon. Ideal for patellar tendonitis (a.k.a. jumper's knee or runner's knee) and Osgood-Schlatter disease. Color: Black.

One Size.....	.41424	\$18.99 ea.
---------------	---------------	-------------

D. The Fluk™ Knee Strap

Made of neoprene rubber with a non-slip backing, the Fluk™ provides soothing heat to the injured area. The moldable insert can be positioned to apply pressure to the patellar tendon, while also improving tracking by lifting the knee cap. Color: Black.

One Size.....	.41373	\$21.99 ea.
---------------	---------------	-------------

E. ACE® Custom Dial Knee Strap

Easy-to-adjust athletic knee strap that delivers focused pressure to help relieve symptoms of tendonitis. Adjustable dial increases or decreases gel pad pressure for maximum comfort, without having to adjust the entire strap.

Adjustable.....	1003584	\$32.99 ea.
-----------------	----------------	-------------

F. Pro-Tec® IT Band Compression Wrap

Relieves conditions of Iliotibial Band Syndrome by providing targeted compression.

One Size Fits All.....	.41786	\$18.99 ea.
------------------------	---------------	-------------

G. McDavid® 4103 Level II Runner's Therapy Iliotibial Band Strap

This adjustable strap provides controllable compression fit and increased support pressure for IT band pain relief. Contoured support pad targeted to IT Band provides healing pressure. Ergonomic, lightweight design for all-workout comfort and fit. Slip-resistant, lined neoprene keeps strap in position during muscle expansion and contraction. Fits left or right. Color: Black.

One Size Fits Most.....	.65102	\$19.99 ea.
-------------------------	---------------	-------------

FREE SHIPPING at SchoolHealth.com/SportsMed

Get FREE SHIPPING on your online order over \$100! Go to the back cover for Free Ship Online code. Can only be used once per customer. Expires 12-31-20.

Thigh & Hip



COMPARE & SAVE!

School Health Brand Thigh Sleeve

Beneficial in the treatment of thigh and groin pulls. Sleeve provides uniform compression and support. Addition of a "pull pad" to the sleeve provides increased heat when placed over the injury area.

Measure mid-thigh circumference		
Size		Black
X-Small	18 1/4"-19"	1002586
Small	19 1/4"-20"	1002585
Medium	20 1/4"-22"	63046
Large	22 1/4"-25"	63047
X-Large	25 1/4"-28"	63048
2X-Large	28 1/4"-31"	63049
All Sizes.....		\$10.99 ea.



Cramer® Groin Strain Brace

Designed to wrap groin, hip adductor, and flexor strains, durable neoprene wrap is easy to apply. Has a solid end for wrapping to provide heat and warmth to the injured area and holes to allow comfort and breathability around the waist area. Color: Black.

One Size Fits All **41379** \$35.99 ea.



McDavid® 475 Groin Strap

Adds warmth and compression to upper thigh and hamstrings. Fully adjustable neoprene strap with nylon facing on outer side. Universal sizing and Velcro® closure assure optimum fit. Also popular as a reusable wrap for large extremities. Color: Black.

..... **41591** \$20.99 ea.



McDavid® 514 Level I Elastic Thigh Sleeve

Contains breathable fabric for maximum comfort. Firm compression and soft tissue support without the heat retention of neoprene supports.

Measure mid-thigh circumference		
Size		Black
Small	18"-20"	63148
Medium	20"-22"	63149
Large	22"-25"	63150
X-Large	25"-28"	63151
All Sizes.....		\$17.99 ea.



Mueller® Thigh Support

Easily adjustable support provides warmth and compression to the quadriceps and hamstring muscles. Provides individual fit for a wide range of sizes. Features contour design for proper fit and fully trimmed edges for durability. Comfortable for all-day wear. Fits thighs 15"-35". Color: Black.

One Size Fits Most..... **41994** \$12.99 ea.



Arthron IMPACT® Pads

- Self-applying without tape or wrap
- Comfortable—won't slip or migrate
- Reusable, making it very economical

Arthron IMPACT Hip Pad..... **41372** \$147.99 ea.

Arthron IMPACT Quad Pad..... **41679** \$119.99 ea.

Not made with Natural Rubber Latex.



A



B



C



D

A. McDavid® 513 Level I Elastic Wrist Sleeve

Features elastic fabric that breathes to keep your wrist cool. Firm compression and soft tissue support. Velcro® strap to control compression. Reduced heat retention. This product does contain latex.

Measure the circumference at wrist		
Size		Item #
Small/Medium	Up to 7"	63164
Large/X-Large	Over 7"	63165
All Sizes.....\$12.99 ea.		

B. PRO 770 Cockup Wrist Support

Features 1/8" neoprene with a nylon lining for ongoing therapeutic heat. Plush outer covering allows hook-type fastening straps, varied attachment points for a customized, and comfortable fit. Color: Black.

Measure the circumference at wrist			
Size		Left	Right
Small	4½"-7¾"	41426	41427
Large	8"-12"	41429	41428
All Sizes.....\$25.99 ea.			

FREE SHIPPING at SchoolHealth.com/SportsMed

Get FREE SHIPPING on your online order over \$100! Go to the back cover for Free Ship Online code. Can only be used once per customer. Expires 12-31-20.

C. EvoShield A150 Protective Wrist Guard

- The custom-molding wrist guard provides the compression of tape, the comfort of cotton, and the protection of a Shield
- Custom-molding insert begins soft and flexible, transforming into a hard and protective Shield in minutes—remove insert from the foil bag to air activate

Size		Item #
Small	5"-6"	63233
Medium	6"-7"	63234
Large	7"-8"	63235
X-Large	8"-9"	63236
All Sizes.....\$29.99 ea.		

D. Mueller® Green Fitted Wrist Brace

Mueller Green products are the same high quality, but made with materials that are environmentally friendly. Instead of traditional neoprene, the Mueller Green Line is made with a material that is manufactured without the use of petroleum. In addition, the green inner lining is manufactured with recycled plastic PET bottles. Mueller Green packaging is all recyclable and the ink is soy-based.

Measure the circumference at wrist			
Size		Right	Left
Small/Medium	5"-8"	63871	63870
Large/X-Large	8"-10"	63872	63873
Black, All Sizes.....\$18.99 ea.			

Wrist & Thumb



A



D



B



C



E

A. Hg80® Wrist Brace

Features two sets of flexible steel springs for double protection. Lightweight inner sleeve keeps brace in place while securing outer tension strap. Composed of moisture-wicking fabric and antimicrobial barrier. Measure around wrist.

Regular, 6"-8" **41841** \$23.99 ea.
Large, 8"-9" **41842** \$23.99 ea.,

B. Cramer® Wrist Wrap

Supports and helps prevent wrist and thumb strain, relieves pain and accelerates recovery.

One Size **.63435** \$12.99 ea.

C. Cramer® Wrist/Thumb Stabilizer

Supports and helps prevent wrist strain, relieves pain, and accelerates recovery.

Features:

- Elastic fabrication compresses and supports the wrist joints
- Rubber openings with soft seams eliminate chafing and preserve integrity
- Strap with hook patch and D-ring secures a comfortably tight fit
- Fits right or left

One Size Fits Most **.63478** \$13.99 ea.

FREE SHIPPING at SchoolHealth.com/SportsMed

Get FREE SHIPPING on your online order over \$100! Go to the back cover for Free Ship Online code. Can only be used once per customer. Expires 12-31-20.

D. ComfortFORM® Wrist Brace

Durable, lightweight fabric is Lycra® lined for breathability and patient comfort. Ideal for sprains, strains, and carpal tunnel syndrome.

Measure the circumference at wrist			
Size		Right	Left
Small	5½"-6½"	41606	41610
Medium	6½"-7½"	41607	41611
Large	7½"-8½"	41608	41612
X-Large	8½"+	41609	41613
All Sizes.....		\$19.99 ea.	

E. ComfortFORM® Wrist Brace with Abducted Thumb

Durable, lightweight fabric is Lycra® lined for breathability and patient comfort. Abducted thumb brace is also used for Gamekeeper's thumb and de Quervain's syndrome.

Measure the circumference at wrist			
Size		Right	Left
Small	5½"-6½"	41615	41620
Medium	6½"-7½"	41616	41621
Large	7½"-8½"	41617	41622
X-Large	8½"+	41618	41623
All Sizes.....		\$36.99 ea.	



A



B



C



D



E

A. Cramer® Moldable Thumb Spica

- Easily applied with one hand
- Heat moldable thermoplastic stay for superior immobilization—adjustable using a heat gun or hydrocollator to accommodate for pressure points, swelling, etc.
- Treats Gamekeeper's thumb, sprains, trauma, tendonitis, overuse injuries, thumb arthritis, MCP injuries or fusion, and joint fractures.

Measure the circumference at wrist		
Size		Item #
Small	5"-6"	63292
Medium	6"-7"	63293
Large	7"-8"	63294
X-Large	8"-9"	63295
All Sizes.....\$33.99 ea.		

B. Zamst Thumb Guard Brace

This thumb guard stabilizes your thumb joint by providing protection and support during activities. Includes a thermoplastic support which can be remolded by placing it in hot water, allowing for a perfect custom fit.

Measure the circumference at wrist		
Size		Item #
Small	5"-6"	1003451
Medium	6"-7"	1003452
Large	7"-8"	1003453
All Sizes.....\$49.99 ea.		

C. ProCare® Universal Thumb-O-Prene

The enhanced universal wrap-around neoprene design provides a low-profile, comfortable, custom fit that is both functional and simple. The unique design combines two stays, rigid, and spiral, plus a movable elastic strap to address various pathologies of the thumb, including Tendonitis, Basal Joint Arthritis and instability of the CMC (Carpometacarpal) joint. The elastic strap may be wrapped between forefinger and thumb to help stabilize the CMC joint, without restricting the use of the thumb or wrist. Bilateral fits right or left.

Universal Size63188 \$24.99 ea.

D. ProCare® Thumb Splint

Universal, wrap-around support with functional features to address a variety of pathologies, including Gamekeeper's/Skier's Thumb, Basal Joint Arthritis, and Thumb Tendonitis. Dorsal, Radial and Palmar stay pockets on thumb contain a malleable aluminum stay and spiral stay that may be removed or modified for desired support. Bilateral fits right or left thumb.

Universal Size63189 \$20.99 ea.

E. EvoShield A130-H Protective Hourglass Multifformat Guard

- These thin, breathable pieces will help brace your thumb and fingers from the hardest hits
- Custom-molding pad begins soft and flexible, transforming into a hard and protective Shield in minutes—remove insert from the foil bag to air activate
- Shields are hand washable—air dry
- Includes one Protective Multi-Use Guard

.....63239 \$30.99 ea.

Elbow



A



B



C



D



E

A. McDavid® 6500 Hex Shooter Arm Sleeve

- 9mm Hex™ Technology positioned at the elbow
- Arm compression maintains muscle warmth and prevents abrasions and scratches
- Color M-Grid
- hDc™ Moisture Management Technology is all about cool and dry
- Machine washable/dryable
- 80% nylon/20% spandex (elastane); polyethylene foam
- Includes one sleeve

Measure the largest part of forearm		
Size		Item #
Small	8"-9½"	1003578
Medium	9½"-11"	1003577
Large	11"-13"	1003576
All Sizes.....		\$24.99 ea.

B. DonJoy Performance Webtech Elbow Strap

Designed for mid-level support and pain management, this elbow strap also prevents and protects from future re-injury. It's three dimensional hex pad construction, and breathable back strap make this effective, comfortable and conforming.

Measure the largest part of forearm		
Size		Item #
Small/Medium	7"-10"	1031968
Large/XL	25"-33"	1031967
All Sizes.....		\$36.99 ea.

C. Cramer® Tennis Elbow Strap

Specially shaped, dual-density, molded foam pads to compress and absorb shock vibration. Pad can be positioned for treatment of either medial or lateral epicondylitis. Color: Black.

One Size Fits All 41532 \$12.99 ea.

D. Mueller® HG80 Tennis Elbow Brace

The Premium HG80 Tennis Elbow Support is simply the most comfortable support you'll wear. The Mueller-exclusive HydraCinn® fabric is a high-performance, moisture-wicking material with an anti-microbial barrier. Neoprene free. Recommended for any activity involving a strong grip or strain on the forearm and elbow, including tennis and golf.

Measure the largest part of forearm		
Size		Item #
Small/Medium	7"-11"	1006183
Large/XL	11"-15"	1006184
All Sizes.....		\$21.99 ea.

E. Padded Elbow Sleeve by Mueller®

Ultimate sleeve for flexibility, comfort and protection. Butress pad cushions and protects elbow. Thinner neoprene on inner side of joint allows full flexibility. Color: Black.

Measure the largest part of forearm		
Size		Item #
Small/Medium	10"-13"	41653
Large/XL	13"-15"	41652
2X/3X-Large	15"-17"	41654
All Sizes.....		\$16.99 ea.

 Not made with Natural Rubber Latex.



A



B



C



D

A. Donjoy® Bionic Elbow Brace

Stretch webbing closure system ensures the proper fit for un-matched comfort and controllable compression. The unique cross strap design allows the user to set the max angle of extension to keep an injured or healing elbow protected. Bilateral polycentric hinges with hyperextension stops in this elbow brace are sure to keep unstable, ligament damaged, sprained elbows from getting in the way of performance.

Features:

- Bilateral polycentric hinges with hyper extension stops help to support unstable elbows
- Innovative cross strap design immobilizes the elbow joint for maximum protection
- Ergonomic construction improves fit and function
- Perforated neoprene for maximum breathability
- Anti-migration technology helps to eliminate slip
- Reflectivity for enhanced visibility in low-light conditions

Measure circumference of the mid-bicep		
Size		Item #
Small	10"-11½"	1007362
Medium	11½"-13"	1007361
Large	13"-14½"	1007360
X-Large	14½"-16"	1007363
All Sizes.....\$87.99 ea.		

B. EvoShield A120 Protective Batter's Elbow Guard

- The Shield provides full coverage without interfering with your performance
 - Custom-molding pad begins soft and flexible, transforming into a hard and protective shield in minutes
 - Impact is dispersed, not absorbed
 - Shields are hand washable—air dry
 - Includes one Protective Elbow Shield, and one Elastic Strap
-**63237** \$42.99 ea.

C. New Options E15 Hyperextension Polycentric Hinged Elbow

¾" nylon, two-sided neoprene. Covered polycentric hinges with hyperextension stop. Hinge has aircraft aluminum arms and stainless steel body. One continuous bottom strap with crisscross lock for desired angle stop. Color: Black.

Measure around the largest circumference of the forearm		
Size		Item #
Small	9"-10"	41793
Medium	10"-11"	41794
Large	11"-12"	41795
All Sizes.....\$56.99 ea.		

D. Bauerfeind® EpiTrain® Elbow Support

- Contoured knit has breathability and provides stretch control
- Two silicone inserts surround the epicondyles and lie over the flexor and extensor muscles
- Silicone inserts leave the epicondyles pressure free and provide compression
- Promotes proprioception, for joint stabilization
- Does not retain heat
- Ideal for epicondylitis, elbow strains or sprains, overuse syndromes
- Machine washable
- Available in Titanium (Gray) or Black

Loose circumference of the arm 4½" below the lateral epicondyle			
Size		Titanium	Black
0	6½"-7½"	63440	63447
1	7½"-8½"	63441	63448
2	8¾"-9"	63442	63449
3	9"-9¾"	63443	63450
4	9¾"-10½"	63444	63451
5	10½"-11½"	63445	63452
6	11½"-12¼"	63446	63453
All Sizes, Colors.....\$68.99 ea.			

Shoulder



Cramer® Shoulder Stabilizer

Supports and stabilizes the shoulder muscles, ligaments, and joints, as well as relieves the symptoms of moderate sprains and strains.

One Size63779 \$51.99 ea.



Mueller® Shoulder Support

The soft neoprene blend used in this shoulder support provides compression, retains body heat to increase circulation, promotes healing, and relieves pain. Recommended for muscle strains, ligament sprains, injuries to rotator cuff, impingement syndrome, arthritis, and bursitis. The multi-strap adjustment system provides a custom fit, while allowing full range. The mesh panel provides breathability and allows use for men and women. X-strap positions and correctly aligns the shoulder.

Measure around the center of chest		
Size	Chest	Item #
X-Small	26"-34"	91668
Small/Medium	32"-40"	91669
Large/X-Large	38"-46"	91670
XX-Large	44"-52"	91671
All Sizes.....		\$64.99 ea.



Flogies AC Pad with Foam

The first AC Pad ever developed. The Floggie is made of molded plastic and lined with Econoline's vinyl foam for added protection and comfort.

.....41655 \$17.80 ea.



Sentry Shoulder Stabilizer

Limits external rotation and abduction. Gives the athlete the protection they need. Not bulky like other shoulder braces.

One Size41404 \$49.99 ea.



Arthron IMPACT® Pads

- Self-applying without tape or wrap
- Comfortable—won't slip or migrate
- Reusable, making it very economical

A. Arthron IMPACT® AC Pad

Regular—under 250 lbs.

Right41316 \$135.99 ea.

Left41317 \$135.99 ea.

Pro—over 250 lbs.

Right41318 \$155.99 ea.

Left41319 \$155.99 ea.

B. Arthron IMPACT® Delt Pad

.....41680 \$99.99 ea.

OSKIE Shoulder Support Braces

Created to prevent or aid in the recovery of shoulder instability, the OSKIE is a one-piece structure that mimics the body's natural joint movement, while maintaining end-range-of-motion support.

Features:

- Provides compression and warmth
- Bilateral
- Lightweight, breathable, and comfortable

Small	1034147	\$128.99 ea.
Medium	1034572	\$128.99 ea.
Large	1034575	\$128.99 ea.
X-Large	1034576	\$128.99 ea.



SFAST Shoulder Support Braces

The patent-pending SFAST is a simple, innovative solution to shoulder joint instability.

Features:

- Customizable shoulder stability
- Simple-to-fit design
- Superior design and materials
- Mimics the body's natural movement
- Adjustable

Small	1034146	\$209.99 ea.
Medium	1034571	\$209.99 ea.
Large	1034573	\$209.99 ea.
X-Large	1034574	\$209.99 ea.



The Sully® Shoulder Stabilizer

Elastic straps attach with Velcro® at any point, in any direction, and with any amount of force you choose. Made of perforated, breathable, rubber-like bifurcated neoprene that grips the skin, so the support moves with the athlete. Includes two 4" neoprene straps, one protective, closed-cell foam pad and one anchor strap for use with shoulder separations.

Size	Chest	Biceps	Item #
Small	34"-40"	11"-13"	41482
Medium	38"-42"	13"-15"	41483
Large	42"-46"	14"-17"	41484
X-Large	46"-51"	15"-17"	41485
All Sizes	\$206.99 ea.		



Torso & Back



A



B



C



D



E

A. Shock Doctor® 838 Ultra Back Support

One of the most advanced lower back support systems to date. By adjusting flawlessly to fit any figure, the lumbar padding and TPR molded lower back stability support help to ease back pain and expedite recovery time.

Performance Level 3: Medium stability and support for moderate to major ligament sprains, muscle strains, and unstable joints allowing for use as necessary for recovery (contains latex).

Features:

- Molded stability supports
- Terry lined lumbar pad
- Vented hex mesh for moisture wicking
- Integrated Antimicrobial Technology to reduce odor causing bacteria

Order by waist size		
Size		Item #
X-Small	26"-30"	1006309
Small/Med	30"-34"	63583
Large/X-Lg	34"-38"	63584
XX-Large	38"-42"	63585
All Sizes.....		\$59.99 ea.

B. PRO 280 Lumbar Support

Adjustable. Color: Beige.

Order by waist size		
Size		Item #
Medium	32¼"-34"	41450
Large	34¼"-36"	41451
X-Large	36¼"-38"	41452
2X-Large	38¼"-42"	41453
All Sizes.....		\$50.99 ea.

C. Cramer® Deluxe Back Stabilizer

Helps prevent lower back strain, improves stability, and reduces muscle fatigue.

Features:

- Double straps with hook-and-loop closures ensure a custom and comfortably secure fit
- Elastic fabrication compresses and supports the lower back muscles
- Plastic stays enhance back support
- Anatomical design conforms naturally to the midsection

Size	Waist Size	Black
Small	27"-32"	63551
Medium	31"-36"	63650
Large	35"-40"	63685
X-Large	39"-40"	63736
All Sizes.....		\$55.99 ea.

D. Mueller® Adjustable Back and Abdominal Support

This revolutionary back and abdominal support uses unique cinching pull-straps for one-handed tightening. For all day support relief from lower back pain, weakness, and fatigue, instant abdominal compression and lumbar support. Smooth, comfortable plastic stays provide support to weak lower back muscles and help maintain healthy posture and alignment. FSA eligible.

.....41999 \$48.99 ea.

E. Mueller® Adjustable Back Brace with Lumbar Pad

Custom fit with dual, outer elastic tension straps.

One Size.....41748 \$34.99 ea.



Mueller® Face Guard

The Mueller Face Guard helps protect maxillary, nasal, zygomatic, and orbital injuries. It's ideal for basketball, wrestling, karate, baseball, soccer, volleyball, and other sports where facemasks are not required.

Features:

- Medical grade polycarbonate
- Improved clarity crack/shatterproof
- Customizable XPE foam padding facilitates better fit, comfort and standoff distance from the face for added protection, and heat management
- Proprietary occipital harness comfortably secures the face guard and prevents shifting
- Anatomically contoured design provides a superior, less obtrusive fit
- Stealthy appearance

.....	1008014	\$49.99 ea.
Pad Kit	1031953	\$8.49 kit
Strapping Kit	1031954	\$16.99 kit

Nose Guard

- Protective acrylic frame distributes impact away from the nose
- Comfortable foam backed construction
- Designed not to interfere with normal vision
- Adjustable head straps

Regular	90084	\$53.99 ea.
Large	91114	\$53.99 ea.



FREE SHIPPING at SchoolHealth.com/SportsMed

Get FREE SHIPPING on your online order over \$100! Go to the back cover for Free Ship Online code. Can only be used once per customer. Expires 12-31-20.

 Not made with Natural Rubber Latex.

Mouthguards



A



B



C



D



E

A. Shock Doctor® Ultra2 STC Lower Profile Super Tight Advanced Compression Gel Fit

Reflects adjustments in structural design and material density that improve the fit and retention of the STC system. The multi-layer design was refined to integrate deeper dual bite zones and a new gel fit formulation. Quick-release tether allows the mouthguard to be used strapped or strapless.

Color	Item #	Color	Item #
Black	91401	Green	91404
Royal	91402	Pink	91405
Orange	91403	Red	91406
All colors.....\$28.99 ea.			

B. Shock Doctor® Braces Mouthguard

- Insta-Fit™—a special ortho-channel fits around brace brackets and adapts to changes in tooth position as braces are adjusted, providing an instant fit and protection from lacerations
- 100% medical-grade silicone for ultimate comfort—no boiling or fitting required
- Strapped models feature quick-release helmet tether
- Meets NFHS wrestling rules requiring full coverage of brace brackets

Upper Braces			
Color	Strapless	Strap	Price
Blue	91311	91313	\$23.99 ea.
Pink	91312	91314	\$23.99 ea.

C. Cramer® Mouthguard with Strap

Clear	90005	\$1.25 ea.
Blue	90054	\$1.25 ea.
Black, Single.....	90055	\$1.25 ea.
Black, 100/pkg	1006794	\$76.99 pkg.
Green	90415	\$1.25 ea.
Pink	91541	\$1.25 ea.
Red.....	90052	\$1.25 ea.
Yellow.....	90416	\$1.25 ea.
Yellow (Jr. Size).....	90418	\$1.25 ea.

D. Mueller® Mouthguard

Co-polymer construction lends comfort and durability. Low profile helps reduce gagging. Thickened posterior area helps absorb impact and oral trauma. Fast-fitting resin.

Color	Strap	Strapless
Black	90537	90604
Blue	90533	90608
Green	90536	90605
Gold	90534	90607
Red	90535	90606
All.....\$1.25 ea.		

E. Shock Doctor® Gel Max Mouthguards

Gel Fit Liner custom molds for a tight, comfortable fit. Exoskeletal shock frame is a heavy duty rubber shock frame with integrated jaw pads that provides maximum impact protection for the teeth, jaw, and brain. Triple-layer design, with integrated breathing creates maximum protection, fit, and comfort with a detachable tether.

Color	Each		48/Case	
	Youth	Adult	Youth	Adult
Blue/Black	91407	91419	91430	91440
Black	91418	91429	91439	91449
Green	91409	91421	91431	91441
Maroon	91416	91427	91437	91447
Orange	91411	91422	91432	91442
Pink	91417	91428	91438	91448
Purple	91414	91425	91435	91445
Red	91412	91423	91433	91443
Royal	91413	91424	91434	91444
Yellow	91415	91426	91436	91446
Individual Mouthguards.....			\$15.99 ea. Bulk, 48/case .. \$480.99 cs.	

Padding, Casting, & Podiatry



Dr. Jill's Gels 53

Moleskin	52
Gel & Felt Padding.....	53-55
Foam Padding	52, 55-57
Econoline Podiatry Products	58-59

Casting Supplies	60
Splinting Supplies	61
Podiatry Products	62-66
Heel Cups.....	67
Blister Care.....	67-68

Foam Padding & Moleskin



Dr. Jill's Heel Lift Pads

(H22), Beveled, 100/pack

Felt, ½", No Adhesive	1007974	\$104.99 pkg.
Felt, ½", With Adhesive	1007921	\$84.99 pkg.
Soft Foam, ½", No Adhesive	1007975	\$70.99 pkg.
Firm Foam, ½", No Adhesive	1007922	\$65.99 pkg.
Firm Foam, ¼", No Adhesive	1008501	\$50.99 pkg.

Dr. Jill's Metatarsal Pad, Skived

100/pack

Felt, ⅛" Thick	1007842	\$40.99 pkg.
Felt, ¼" Thick	1007841	\$50.99 pkg.
Firm Foam, 2 ¼" x 2 ¼", ⅛" Thick, No Adhesive	1008020	\$57.99 pkg.

Moleskin



A



B



C



D

A. Heavy Duty Adhesive Moleskin

Strap 'N' Cut

1 ½" x 25 yds.....	.29052	\$34.99 roll
2" x 25 yds.....	.29053	\$39.99 roll
3" x 25 yds.....	.29054	\$56.99 roll

Rolled Sheets

7" x 1 yd.....	.29034	\$10.99 ea.
9" x 4 yds.....	.29035	\$40.99 ea.
12" x 5 yds.....	.29048	\$51.99 ea.

B. Moleskin Strapping Strips

- Pre-cut ankle support straps
- Notched for flat/smooth application
- Heavy duty support for acute ankle taping

2", 25/bag.....	.29469	\$22.99 bag
3", 25/bag.....	.29470	\$32.99 bag

C. Turf Toe Straps

(TT-61), 2" x 7 ½"

25/pkg.....	.29008	\$23.99 pkg.
100/pkg.....	.29104	\$64.99 pkg.

D. Plantar Fascia Straps

Made of heavyweight moleskin.

(P-59), 2" x 9", 25/pkg..... **.29449** \$11.99 pkg.

(P-60), 3" x 11"

Made of heavyweight moleskin.

25/pkg..... **.29450** \$22.99 pkg.

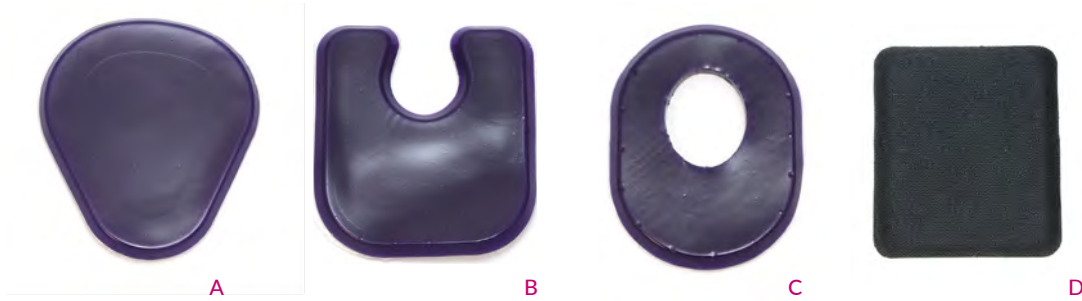

A. Dr. Jill's Dancers Pad

This soft gel pad cushions the ball of the foot and reduces pressure under any of the metatarsal heads, especially the big toe joint. A cut out surrounds the area to re-distribute weight onto the pad and away from the painful area, relieving stress, tenderness, and pain. Self-stick for easy application; wash and use over-and-over again. Two choices of thickness make it ideal for all styles of footwear. Use for calluses, dropped metatarsal head pain, fat pad atrophy, hallux limitus, hallus valgus, and metatarsalgia.

Regular Thickness: 1/8" thick gel pad, 2/package		
Left	1007753	\$5.99 pkg.
Right	1007755	\$5.99 pkg.
Extra Thickness: 1/4" thick gel pad, 2/package		
Left	1007754	\$6.99 pkg.
Right	1007756	\$6.99 pkg.

Dr. Jill's Callus Cushions

These soft gel cushions provide long-lasting comfort by protecting the ball of the foot and reducing pressure while walking or standing. A center hole surrounds the sore callus and transfers the pressure to the cushion, alleviating discomfort. For use in all styles of footwear. Self-stick cushions are easy to apply and can be washed and used over-and-over again. Includes a smaller bonus pad to protect any tender spot where shoes rub. Use for calluses, dropped metatarsal head pain, fat pad atrophy, neuroma, metatarsalgia, and IPKs.

B. U Shape: 1/8" thick gel pad, 2/package		
.....	1007725	\$6.23 pkg.
C. Oval Shape: 1/4" thick gel pad, 2/package		
.....	1007724	\$6.23 pkg.

D. Dr. Jill's Gelskin

Features:

- Durable, stretchy fabric top cover
- Adheres to skin, cushions and protects
- Great for corns, blisters, bunions, heels, and more
- Trim sheets to any shape for custom padding

2 1/2" x 3", Cut to Size, 2/Pack	1007840	\$5.49 pkg.
2 1/2" x 3", Cut to Size, 10/Pack	1007865	\$27.99 pkg.



E. Dr. Jill's Ball-Of-Foot Gel Pads

Features:

These soft gel pads provide excellent cushioning and long-lasting comfort while walking or standing. The pads cushion the ball of foot or offload metatarsal heads, depending on if they are placed directly on top or behind the ball of foot. Regular thickness pads can be placed directly on the painful area for general cushioning while standing for long hours. Extra-thick pads can be placed directly on the ball of the foot, although many doctors may direct them to be placed behind. Self-stick for easy application; washable and reusable again and again. For use in all styles of footwear. Two choices of thickness ensure a comfortable fit. Use for calluses, dropped metatarsal head pain, fat pad atrophy, neuroma, and metatarsalgia.

Regular Thickness: 1/8" Thick Gel Pad,		
2/pkg.	1007726	\$5.99 pkg.
Extra Thickness: 1/4" Thick Gel Pad,		
2/pkg.	1007727	\$6.99 pkg.

F. Dr. Jill's Arch Pad

Soft gel pad supports fallen arches, weak arches, high arches requiring additional support, tired feet, and weak arches, as well as pronation-related foot problems. Self-stick cushions are easy to apply. Washable and reusable. Appropriate for all styles of footwear. Two choices of thickness for comfortable fit.

Regular Thickness: 1/8" thick gel pad, 2/pkg.	1007740	\$5.99 pkg.
Extra Thickness: 1/4" thick gel pad, 2/pkg.	1007741	\$6.99 pkg.

G. Dr. Jill's Gel Sheet, Self-Sticking

Features:

- Durable, stretchy fabric top cover
- Adheres to skin, cushions and protects
- Great for corns, blisters, bunions, heels, and more
- Trim sheets to any shape for custom padding

9" x 20", 1/8" Thick	1008022	\$43.99 ea.
9" x 20", 1/4" Thick	1008021	\$54.99 ea.

Not made with Natural Rubber Latex.

Gel & Felt Padding

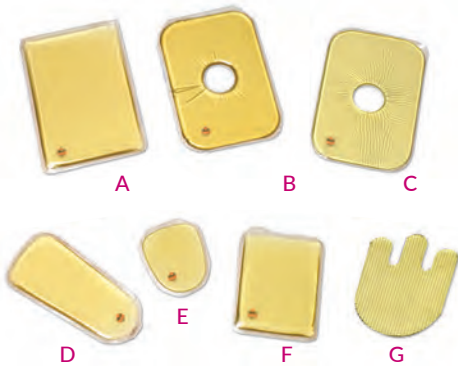

Econoline® Shock Shield Custom Pads

A. Rectangular Multi-Use Pad

5/16" x 9" x 6".....41919 \$38.99 ea.

B. Acromio Clavicular Pad with Liner

5/16".....41915 \$64.99 pr.

C. Acromio Clavicular Pad

.....41916 \$57.99 pr.

D. Forearm/Shin Pad

5/16".....41918 \$36.99 ea.



Econoline® Orthopedic Felt Sheets

Econoline's felt is the highest quality—70% wool and 30% rayon. Felt is used to customize padding for injured areas, splints, blister care, and many foot-related applications.

21" x 36"

1/8".....29043 \$19.99 ea.

1/4".....29015 \$29.99 ea.

1/2".....29016 \$47.99 ea.

Variety Pack, 9" x 9"

One each 1/8", two each 1/4", one each 1/2"

4/pkg.....29060 \$19.99 pkg.



Econoline® Adhesive Felt Rolls

6" x 2 1/2 yds.

1/8".....29045 \$28.99 roll

1/4".....29175 \$29.99 roll

Econoline® Shock Shield

Shock Shield is gel-like padding material made with shock absorbing polymer technology designed to disperse high-impact force protection. Econoline manufactures original Shock Shield in 12" x 22" x 3/16" sheets with an adhesive release-liner for tactical padding creations. Newly developed Shock Shield Lite, same as the original, is only 1/16" thick, so it's thinner and lighter, without compromising the Shock Shield protection qualities. Shock Shield technology is now available in newly designed custom-formed padding shaped for specific body applications. The Shock Shield product line is manufactured with the serious protection of athletes in mind.

E. Dorsal Hand Pad

3/16".....41917 \$31.99 ea.

F. Rectangular Multi-Use Pad, Small

5/16" x 6" x 4 1/2".....41920 \$27.99 ea.

G. Palmer Hand Pad

4/pkg.....41059 \$23.99 pkg.

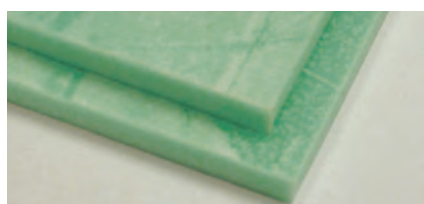

Econoline® Memory Gel

Similar to Memory Foam, only this gel-like material offers more shock absorption. Two, 1/2" thick sheets. Allows your athletes to resume play with comfort and protection.

8" x 16"

2/pkg.....29366 \$103.99 pkg.



Cramer® OrthoGel™ Padding

Use it for horseshoes on sprains, absorbent pads inside chin straps, donuts for hip pointers, and A/C contusions, and compression strips for shin splints. OrthoGel™ padding can be used right from the freezer, providing both cryotherapy and cushioning.

Kit, 12" x 12"

1/8", 2 sheets/kit.29269 \$34.99 kit

1/4", 2 sheets/kit.29268 \$41.99 kit

3/8", 2 sheets/kit.29270 \$56.99 kit

Variety Pack, 12" x 12"

One each 1/8", 1/4", 3/8"

3/kit.....29010 \$71.99 kit

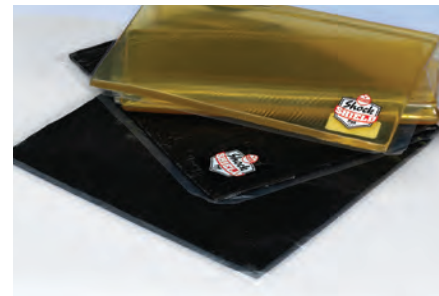

Econoline® Shock Shield Pad

Gel-like, shock-absorbing padding can be cut and conformed for any padded protection. Shock Shield Pad disperses the force of contact, making it essential for the protection of injured areas—especially those that receive repeated contact. One adhesive side.

5/16" x 12" x 22"29126 \$74.99 ea.

Shock Shield Lite

3/16" x 12" x 22"29468 \$69.99 ea.

Shock Shield Mini

1/8" x 10" x 12"29527 \$49.99 ea.



Cramer® OSI® Pads

With this patented, custom-fit, fiberglass technology, you don't have to take the athlete off the field to cut and custom fit a pad. Just rip open a package, wet with any liquid and in five minutes the athlete is ready to return. Once formed, Cramer OSI® pads are washable and durable enough to provide protection for an entire season. Pads are not remoldable.

A. 2" x 5", Finger29160 \$16.99 ea.

B. 3" x 6", Oval29156 \$16.99 ea.

C. 4" x 8", Knee/Elbow

.....29147 \$14.99 ea.

D. 4" x 8", Foot29148 \$16.99 ea.

3" x 3", Thumb.29150 \$10.99 ea.

E. 6" x 6", Square29163 \$22.99 ea.

5" x 5", Square.29162 \$16.99 ea.

F. 9" x 4", Forearm/Shin

.....29151 \$20.99 ea.

G. 11" x 7", Thigh/Leg

.....29152 \$39.99 ea.

Not made with Natural Rubber Latex.

Foam, Gel, & Felt Padding

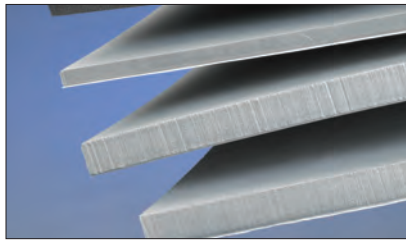

A

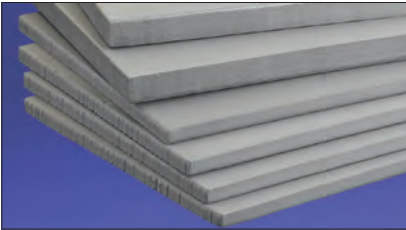

B



C



D



E



F

A. Econoline® American Foam

A unique polyethylene material that is dense, but surprisingly lightweight. American Foam is water-repellent and used for almost any foam padding need. Great for traveling to away games, due to its versatility, light weight, and convenient packaging. Gray.

12" x 44"		
¼"29110	\$18.62 ea.
½"29111	\$24.28 ea.
12" x 44" with Adhesive		
¼"29313	\$17.74 ea.
½"29314	\$24.93 ea.

B. Econoline® American Foam Mini Kit

Made from a unique polyethylene material—quite dense, but lightweight and water-repellent. Convenient for packing in an athletic trainer's kit. Gray.

Six 6" x 12" sheets: two each ½", four each ¼"		
(6 sheets/kit)		
American Foam Mini Kit29112	\$15.89 kit
American Foam Mini Kit with Adhesive29315	\$19.35 kit



Soft Ortho Foam

21" x 36" Sheet		
⅛"29037	\$18.99 ea.
¼"29014	\$27.99 ea.
½"29011	\$61.99 ea.
6" x 12" Sheets with Adhesive (4) ⅛" Thick, (4) ¼" Thick		
8/pkg.29039	\$21.99 pkg.
Variety Pack, 6" x 12" Sheets (4) ¼" Thick, (2) ½" Thick		
6/pkg.29005	\$23.90 pkg.
6" x 2 yds., Roll with Adhesive		
⅛"29004	\$15.99 ea.
¼"29003	\$17.99 ea.

C. Econoline® Foameze

Soft, low-density foam squares. The convenient size covers most padding needs, and it is packaged to travel.

4" x 4"		
⅛", Peach, 25/pkg.29399	\$11.99 pkg.
¼", White, 25/pkg.29401	\$17.99 pkg.
6" x 6"		
⅛", Peach, 25/pkg.29400	\$31.99 pkg.
¼", White, 25/pkg.29402	\$32.99 pkg.

D. Econoline® Phalanx Foam Kit

Includes three sizes of foam rolls that fit around the patient's fingers or toes. Normally a cumbersome area to pad, these foam rolls can be cut to the desired length, providing protection to an injured digit.

Contains three 12" foam tubes: (1) ⅝", (1) ⅞", (1) 1"		
.....29319		\$6.70 kit

Econoline® Shock Shield Shoulder/Hip Pad Inserts

Great padding protection for the shoulder and hips. Designed to be used in conjunction with football shoulder and hip pads. Uses Econoline's Shock Shield technology. Tested and approved by the NFL. Simply attach with Velcro®, and football players can compete while receiving the additional protection they need. Sold in pairs.

E. Shoulder Pad41520	\$99.99 pr.
F. Hip Pad41644	\$82.99 pr.

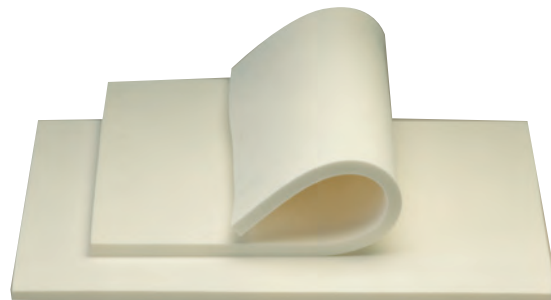

Cramer® Foam Cast Cover Sheets

12" x 18" x ½" Sheets, 2/pkg.21155	\$38.99 pkg.
-------------------------------	------------	--------------

PADDING, CASTING, & PODIATRY

Foam Padding

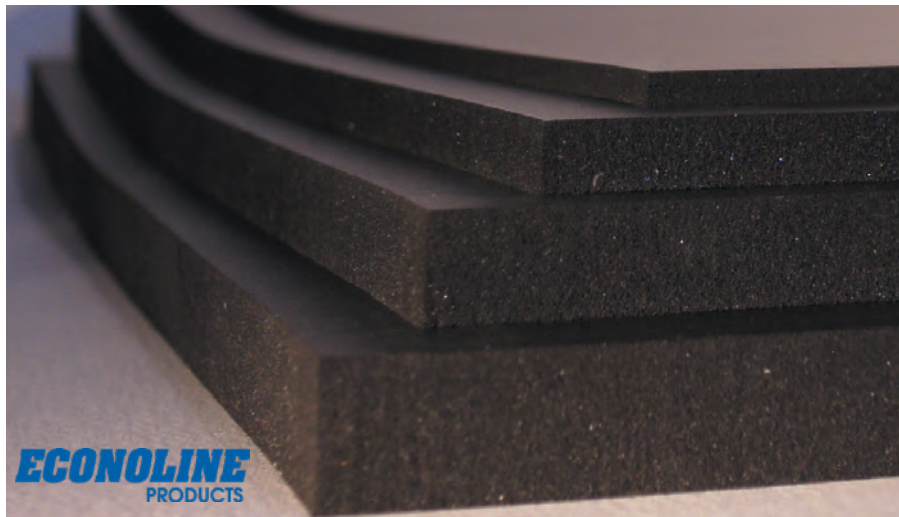

Econoline® Super Foam Sheets

Super Foam is one of Econoline's finest products, preferred by many athletic trainers across the United States. This porous material is very dense, extremely durable, and non-impressionable. Super Foam can also be washed and dried. Recommended for cast padding, orthotics, AC pads, and more. Some athletic trainers compare Super Foam to the old Belgium foam. Color: Black.

Super Foam Kit, 12" x 24" Sheets

3/kit, (1) 1/8", (1) 1/4", (1) 1/2"	29121	\$61.53 kit
With Adhesive	29300	\$62.20 kit

Super Foam Mini Kit, 6" x 12" Sheets

6/kit, (2) 1/2", (4) 1/4"	29122	\$33.53 kit
With Adhesive	29123	\$36.33 kit

Super Foam Heel Spurs with Adhesive

1/4", 12/pkg.	29454	\$6.55 pkg.
3/8", 12/pkg.	29455	\$9.39 pkg.
1/2", 12/pkg.	29456	\$10.17 pkg.

Super Foam Heel Lifts with Adhesive

1/4", 12/pkg.	29451	\$10.92 pkg.
3/8", 12/pkg.	29452	\$12.01 pkg.
1/2", 12/pkg.	29453	\$14.90 pkg.

Foam Sheets, 21" x 36"

1/8"	29138	\$39.31 ea.
1/4"	29120	\$55.04 ea.
3/8"	29119	\$64.55 ea.
1/2"	29118	\$75.95 ea.

Foam Sheets with Adhesive, 21" x 36"

1/8"	29299	\$63.76 ea.
1/4"	29298	\$56.45 ea.
3/8"	29297	\$67.23 ea.
1/2"	29296	\$83.50 ea.



Econoline® Eline Ankle Horseshoes

Horseshoe-shaped super foam product, used to control swelling during ankle sprains.

12/pkg.		
1/4"	29460	\$23.24 pkg.
3/8"	29461	\$27.12 pkg.
1/2"	29462	\$34.67 pkg.

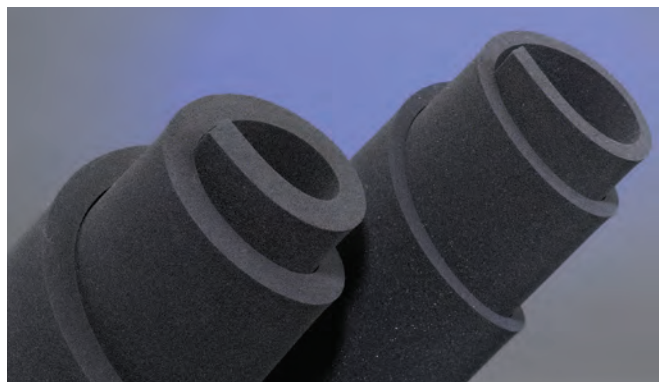

Econoline® Stingray Foam

High durability. Very lightweight. Has a neoprene texture that makes it somewhat weatherproof. Designed to be used for any foam need. It forms easily and absorbs shock well. Can be used as an impact pad, an orthotic, or for any training room padding requirement. Extremely useful, handy, and economical.

1/4" x 20" x 30" Sheet	29359	\$31.20 ea.
1/2" x 20" x 30" Sheet	29361	\$44.74 ea.
1/4" x 20" x 30" Sheet with Adhesive	29362	\$33.26 ea.
1/2" x 20" x 30" Sheet with Adhesive	29363	\$33.26 ea.

FREE SHIPPING at SchoolHealth.com/SportsMed

Get FREE SHIPPING on your online order over \$100! Go to the back cover for Free Ship Online code. Can only be used once per customer. Expires 12-31-20.



Econoline® Memory Foam Sheets

An athletic training room essential. One of the most extraordinary foam products available to the sports medicine profession. This temper foam material has a great shock-absorbing quality that will protect the desired area. It is a heat-sensitive, slow-recovery foam. Specially designed to conform and be molded for protection. Because we manufacture Memory Foam in four different densities and three varying widths, it suits a variety of sports medicine needs.

20" x 36"

Soft Density, Pink

1/2".....	.29129	\$50.54 ea.
3/4".....	.29130	\$73.76 ea.
1".....	.29131	\$77.65 ea.

Medium Density, Blue

1/2".....	.29113	\$50.54 ea.
3/4".....	.29114	\$73.76 ea.
1".....	.29115	\$77.65 ea.

Firm Density, Green

1/2".....	.29132	\$50.54 ea.
3/4".....	.29133	\$73.76 ea.
1".....	.29134	\$77.65 ea.

20" x 36" with Adhesive

Soft Density, Pink

1/2".....	.29301	\$44.63 ea.
3/4".....	.29302	\$62.90 ea.
1".....	.29303	\$82.37 ea.

Medium Density, Blue

1/2".....	.29304	\$44.63 ea.
3/4".....	.29305	\$62.90 ea.
1".....	.29306	\$82.37 ea.

Firm Density, Green

1/2".....	.29307	\$44.63 ea.
3/4".....	.29308	\$62.90 ea.
1".....	.29309	\$83.34 ea.

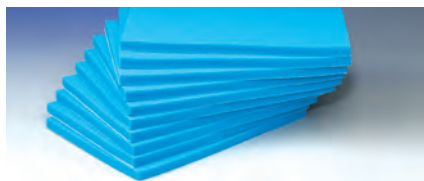

Econoline® Memory Foam 10 Pack Kit with Adhesive

8" x 12", 10 sheets/kit

Soft Density, Pink

1/2".....	.29279	\$65.52 kit
3/4".....	.29280	\$53.10 kit

Medium Density, Blue

1/2".....	.29117	\$65.52 kit
3/4".....	.29168	\$53.10 kit

Firm Density, Green

1/2".....	.29169	\$65.52 kit
3/4".....	.29170	\$53.10 kit

Econoline® Memory Foam Kits

12" x 10" Sheets

3/kit: (1) 1/2", (1) 3/4", (1) 1"

Soft Density, Pink

.....	.29135	\$22.93 kit
-------	---------------	-------------

Medium Density, Blue

.....	.29116	\$22.93 kit
-------	---------------	-------------

Firm Density, Green

.....	.29136	\$22.93 kit
-------	---------------	-------------

12" x 10" Sheet with Adhesive

3/kit: (1) 1/2", (1) 3/4", (1) 1"

Soft Density, Pink

.....	.29310	\$27.69 kit
-------	---------------	-------------

Medium Density, Blue

.....	.29311	\$27.69 kit
-------	---------------	-------------

Firm Density, Green

.....	.29312	\$27.69 kit
-------	---------------	-------------



McDavid® 6650 Hex Skin

Hex Skin is engineered to help protect the body from impact, burn, and abrasion. Simply cut to length and apply directly to skin. Best for body-to-body contact and body-to-surface contact. Stays in place during sports and other activities.

Features:

- Long-lasting, comfortable, lightweight
- Best for body-to-body contact and body-to-surface contact
- Featuring 4 mm Hex Pad protection
- Breathable, hypo-allergenic
- Water and sweat resistant

3' x 4" Roll **1006327** \$21.99 ea.

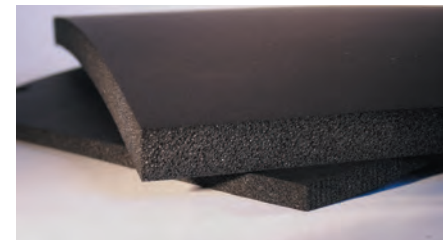

Econoline® Black Vinyl Foam Sheets

A vinyl-nitrate porous material developed as a multi-use foam. Primarily used for protective padding. Its cushioning texture molds well. Vinyl Foam is affordable and economical. Color: Black.

21" x 48"

1/4".....	.29457	\$31.05 ea.
-----------	---------------	-------------

3/8".....	.29458	\$41.24 ea.
-----------	---------------	-------------

1/2".....	.29459	\$55.17 ea.
-----------	---------------	-------------

21" x 48" with Adhesive

1/4".....	.29463	\$38.09 ea.
-----------	---------------	-------------

3/8".....	.29464	\$26.65 ea.
-----------	---------------	-------------

1/2".....	.29465	\$48.80 ea.
-----------	---------------	-------------

Econoline® Podiatry Products

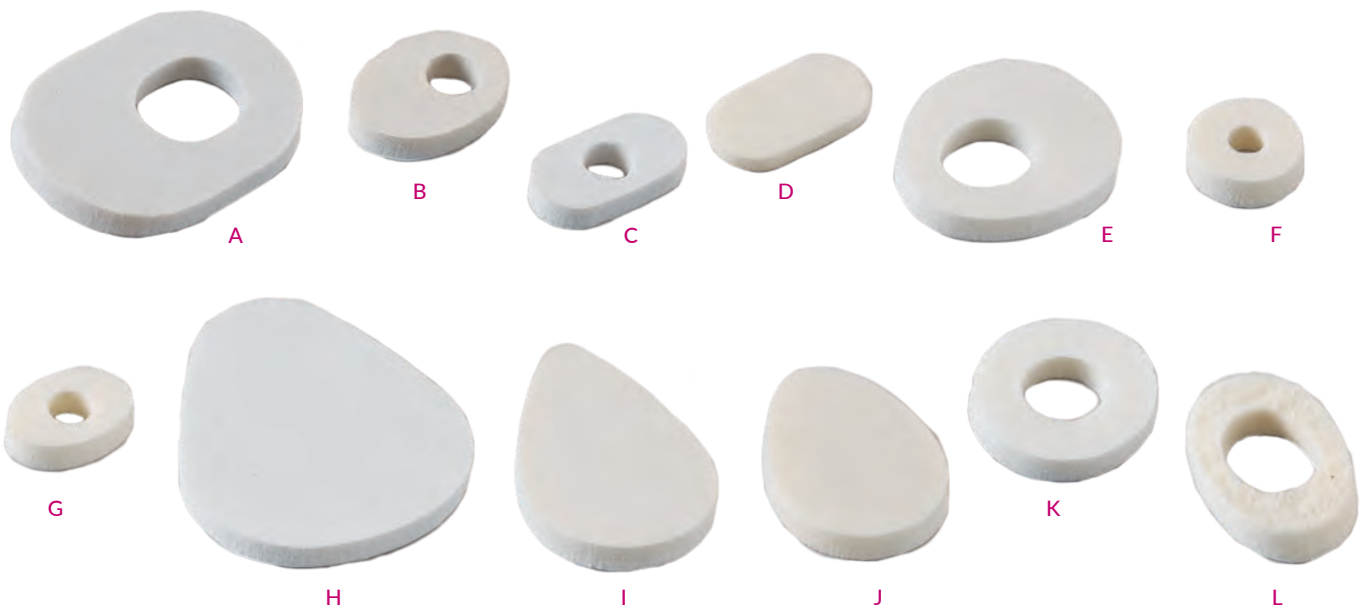

Econoline® Corn, Blister, and Metatarsal Pads with Adhesive Backing

Customized padding for general blister care and other foot-related injuries. FDA approved, with hypoallergenic adhesive backing included on each pad. Made from Econoline's signature high-quality foam and felt. Color: White.

A. Corn Pad (C-2), 2¼" x 1½", 100/pkg.

Ortho Foam		
1/8".....	.29064	\$20.99 pkg.
1/4".....	.29065	\$27.99 pkg.
Ortho Felt		
1/8".....	.29066	\$30.99 pkg.
1/4".....	.29067	\$46.99 pkg.

B. Corn Pad (C-3), 1½" x 1", 100/pkg.

Ortho Foam		
1/8".....	.29219	\$11.99 pkg.
1/4".....	.29207	\$12.99 pkg.
Ortho Felt		
1/8".....	.29201	\$13.99 pkg.
1/4".....	.29193	\$24.99 pkg.

C. Corn Pad (C-5), 1¼" x ¾", 100/pkg.

Ortho Foam		
1/8".....	.29284	\$8.99 pkg.
1/4".....	.29209	\$14.99 pkg.
Ortho Felt		
1/8".....	.29286	\$11.99 pkg.
1/4".....	.29198	\$23.99 pkg.

D. Corn Pad (C-6), 1¼" x ¾", 100/pkg.

Ortho Foam		
1/8".....	.29283	\$9.99 pkg.
1/4".....	.29282	\$11.99 pkg.
Ortho Felt		
1/8".....	.29204	\$11.99 pkg.
1/4".....	.29281	\$23.99 pkg.

E. Corn Pad (C-8), 1⅞" x 1½", 100/pkg.

Ortho Foam		
1/8".....	.29218	\$21.99 pkg.
1/4".....	.29206	\$24.99 pkg.
Ortho Felt		
1/8".....	.29199	\$27.99 pkg.
1/4".....	.29194	\$42.99 pkg.

F. Corn Pad (C-36), ⅞" Round, 100/pkg.

Ortho Foam		
1/8".....	.29217	\$11.99 pkg.
1/4".....	.29213	\$15.99 pkg.
Ortho Felt		
1/8".....	.29200	\$11.99 pkg.
1/4".....	.29197	\$20.99 pkg.

G. Corn Pad (C-38), 1" x ¾", 100/pkg.

Ortho Foam		
1/8".....	.29214	\$11.99 pkg.
1/4".....	.29208	\$16.99 pkg.
Ortho Felt		
1/8".....	.29205	\$12.99 pkg.
1/4".....	.29196	\$20.99 pkg.

H. Large Metatarsal Pad (M-10), 2¼" x 2¼", 25/pkg.

Ortho Foam		
1/8".....	.29439	\$6.99 pkg.
1/4".....	.29440	\$8.99 pkg.
Ortho Felt		
1/8".....	.29437	\$11.99 pkg.
1/4".....	.29438	\$20.99 pkg.

I. Metatarsal Pad (M-42), 2¼" x 1½", 25/pkg.

Ortho Foam		
1/8".....	.29443	\$4.99 pkg.
1/4".....	.29444	\$5.99 pkg.
Ortho Felt		
1/8".....	.29441	\$8.99 pkg.
1/4".....	.29442	\$14.99 pkg.

J. Metatarsal Pad (M-43), 1⅞" x 1½", 25/pkg.

Ortho Foam		
1/8".....	.29447	\$4.99 pkg.
1/4".....	.29448	\$4.99 pkg.
Ortho Felt		
1/8".....	.29445	\$6.99 pkg.
1/4".....	.29446	\$9.99 pkg.

K. Blister Pad (B-39), 1⅞" Round, 100/pkg.

Ortho Foam		
1/8".....	.29029	\$12.99 pkg.
1/4".....	.29030	\$13.99 pkg.
Ortho Felt		
1/8".....	.29031	\$18.99 pkg.
1/4".....	.29032	\$27.99 pkg.

L. Blister Pad (B-41), 1½" x 1¼", 100/pkg.

Ortho Foam		
1/8".....	.29033	\$16.99 pkg.
1/4".....	.29036	\$18.99 pkg.
Ortho Felt		
1/8".....	.29044	\$23.99 pkg.
1/4".....	.29063	\$33.99 pkg.

Econoline® Podiatry Products

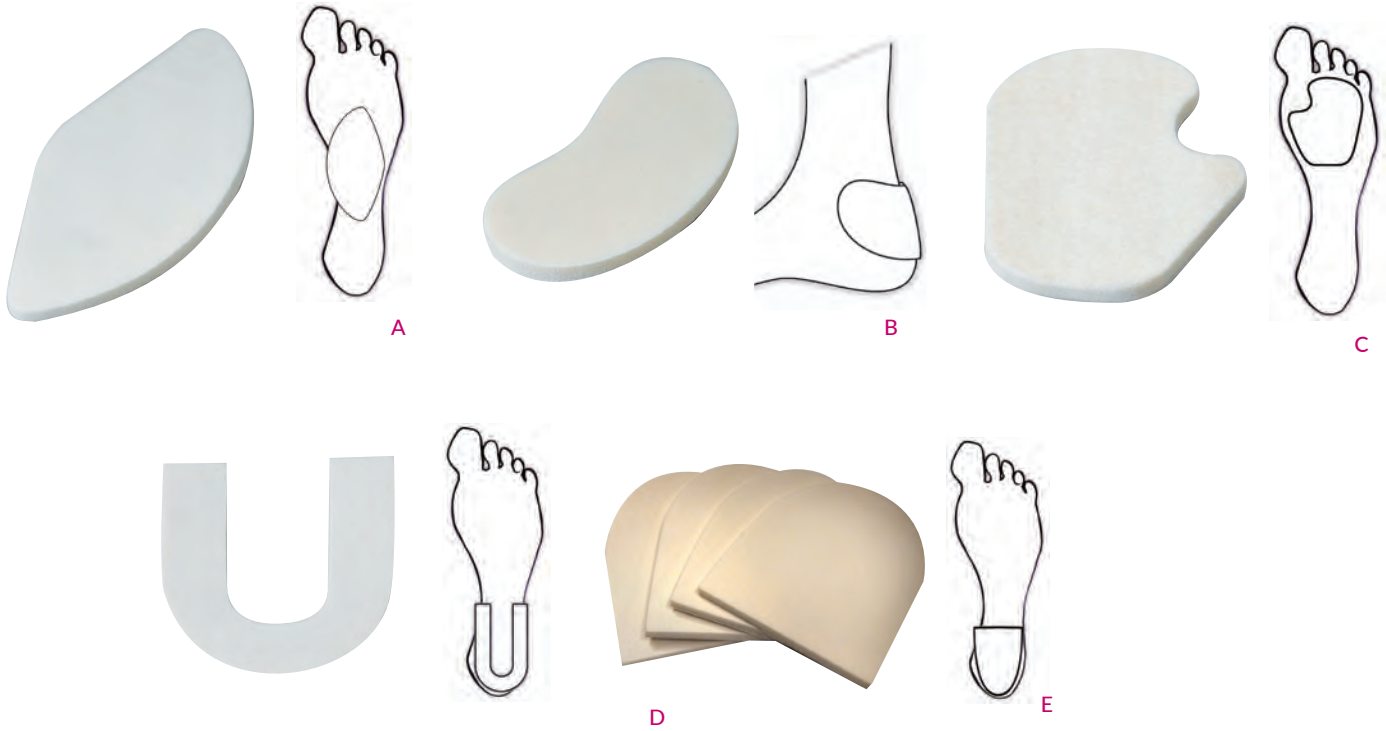

ECONOLINE
PRODUCTS

A. Longitudinal Arch Pads (LA-24), 4½" x 2½", 25/pkg.

Ortho Foam, White		
⅛"29405	\$11.99 pkg.
¼"29406	\$18.99 pkg.
Ortho Felt, White		
⅛"29403	\$16.99 pkg.
¼"29404	\$26.99 pkg.

Large Longitudinal Arch Pads (LA-25), 5¼" x 2⅝", 25/pkg.

Ortho Foam, White		
⅛"29409	\$20.99 pkg.
¼"29410	\$21.99 pkg.
Ortho Felt, White		
⅛"29407	\$23.99 pkg.
¼"29408	\$34.99 pkg.

B. Small Heel Pads (K-15), 3" x 1¼", 25/pkg.

Ortho Foam, White		
⅛"29421	\$5.99 pkg.
¼"29422	\$8.99 pkg.
Ortho Felt, White		
⅛"29419	\$8.99 pkg.
¼"29420	\$15.99 pkg.

Large Heel Pads (K-16), 3½" x 1⅞", 25/pkg.

Ortho Foam, White		
⅛"29425	\$6.99 pkg.
¼"29426	\$8.99 pkg.
Ortho Felt, White		
⅛"29423	\$10.99 pkg.
¼"29424	\$19.99 pkg.

C. Sesamoid (Dancer's) Pad (P-30), 3⅝" x 2¾", 25/pkg.

Ortho Foam, White		
Left Foot		
⅛"29416	\$10.99 pkg.
¼"29418	\$10.99 pkg.
Right Foot		
⅛"29415	\$10.99 pkg.
¼"29417	\$10.99 pkg.
Ortho Felt, White		
Left Foot		
⅛"29412	\$15.99 pkg.
¼"29414	\$21.99 pkg.
Right Foot		
⅛"29411	\$15.99 pkg.
¼"29413	\$21.99 pkg.

D. Heel Spur Pads (H-21), 3" x 2¾", 25/pkg.

Ortho Foam, White		
⅛"29431	\$12.99 pkg.
¼"29432	\$13.99 pkg.
Ortho Felt, White		
⅛"29429	\$16.99 pkg.
¼"29430	\$23.99 pkg.

E. Heel Lift Pads (H-22), 3" x 2¾", 25/pkg.

Ortho Foam, White		
⅛"29435	\$9.99 pkg.
¼"29436	\$14.99 pkg.
Ortho Felt, White		
⅛"29433	\$16.99 pkg.
¼"29434	\$26.99 pkg.

PADDING, CASTING, & PODIATRY

Casting Supplies



A. Specialist® 100 Cotton Cast Padding

Specialist® 100 has the product features cotton users desire. The soft, 100% cotton material feathers and self-bonds to create a smooth undercast surface. Specialist® 100 is hand-tearable and applies easily. Excellent cohesion allows for custom padding around bony prominences.

2" x 4 yds., 24/pkg.29484	\$31.99 pkg.
3" x 4 yds., 12/pkg.29485	\$22.99 pkg.
4" x 4 yds., 12/pkg.29486	\$31.99 pkg.

B. Specialist® Cast Padding

Designed to provide excellent under-cast protection without time-consuming application. A unique micropleated design results in excellent cast padding conformability, protection, and ease of application, without tucking and tearing.

2" x 4 yds., 24/bag29012	\$38.99 bag
3" x 4 yds., 12/bag29013	\$29.99 bag
4" x 4 yds., 12/bag29023	\$42.99 bag

C. Sof-Rol® Cast Padding

Designed to maximize the wicking of body exudates under a cast. Constructed of 100% surgical grade, needle-loomed rayon, this padding combines high-tensile strength with superior absorbency. Sof-Rol® is soft and cool for maximum under-cast comfort.

3" x 4 yds., 12/bag29028	\$31.99 bag
4" x 4 yds., 12/bag29026	\$39.99 bag

D. Delta-Lite® Conformable Fiberglass Cast Tape

The patented fiberglass substrate provides unsurpassed conformability, greatly reducing the need to tuck and fold during application. Primary and secondary casting, rigid support, superior conformability, exceptional strength, excellent lamination, three-dimensional stretch, weight bearing in approximately 20 minutes, 3-5 minute set time.

10/box		
2" x 4 yds.....	.29473	\$162.99 box
3" x 4 yds.....	.29474	\$264.99 box
4" x 4 yds.....	.29475	\$344.99 box
5" x 4 yds.....	.29476	\$293.99 box

Delta-Lite Plus® Fiberglass Casting Tape (Not Shown)

With added smoothness and moldability. Sets in 7 minutes. Dip-water activated and applied like plaster. Finished casts are moisture resistant, lightweight, strong, porous, and easily removed with a cast cutter.

10/box		
2" x 4 yds.....	.29494	\$71.99 box
3" x 4 yds.....	.29495	\$86.99 box
4" x 4 yds.....	.29496	\$101.99 box
5" x 4 yds.....	.29497	\$128.99 box

E. 3M™ Scotchcast™ Soft Cast Tape

Semi-rigid support wrap is as fast and easy to apply as casting tape, but flexible and semi-rigid for resilient support. The degree of rigidity is controllable by the number of layers used to meet the requirements of each situation.

2" x 4 yds.....	.20056	\$15.99 roll
3" x 4 yds.....	.20057	\$17.99 roll

F. 3M™ Scotchcast™ Plus Casting Tape

Lightweight, durable, easy-to-wrap, synthetic casting material. Scotchcast™ Plus is a roll of resin infused fiberglass tape.

3" x 4 yds.....	.20058	\$17.99 roll
4" x 4 yds.....	.20059	\$20.99 roll

G. Delta-Cast Conformable

Patented, semi-rigid, elasticized polyester is easy to wrap. Conforms around difficult body contours, reducing the need for cutting and shaping. Free of slip additives, long-lasting, problem-free casts. Sets in four minutes and bears weight in 20 to 30 minutes. Easily removed using normal bandage scissors.

10 rolls/box		
2" x 4 yds.....	.29350	\$211.99 box
3" x 4 yds.....	.29349	\$226.99 box
4" x 4 yds.....	.29348	\$294.99 box
5" x 4 yds.....	.29347	\$331.99 box

H. Delta-Rol® Synthetic Cast Padding

Constructed of 100% acrylic fibers that wick moisture away from the skin. Easy to tear, highly conformable, and will maintain its bulk even when wet, resulting in an excellent, continuous cast fit.

2" x 4 yds., 24/pkg.29480	\$62.99 pkg.
3" x 4 yds., 12/pkg.29481	\$57.99 pkg.
4" x 4 yds., 12/pkg.29482	\$73.99 pkg.
6" x 4 yds., 6/pkg.....	.29483	\$57.99 pkg.

I. Delta-Dry® Cast Padding

Delta-Dry® is waterproof, breathable and washable, and allows patients restricted by casts to bathe easily, and even go swimming. Even rehabilitative measures such as hydrotherapy can be taken, thanks to the waterproof sub-padding.

12/box		
3" x 2.6 yds.29478	\$232.99 box
4" x 2.6 yds.....	.29479	\$287.99 box

J. M-Pact® Cast Cutter

Cast Cutter36022	\$1,917.00 ea.
Replacement Blade36026	\$101.50 ea.

 Not made with Natural Rubber Latex.

CUSTOMIZABLE FOR MULTIPLE APPLICATIONS!



Orfit NS Splinting Material

Orfit NS has unlimited potential for fabrication of very large to very small splints. It features a non-stick, coated material that prevents accidental bonding. The material allows for precise moulding that conforms to patient anatomy. It becomes transparent when activated in hot water (160 degrees F) and returns to white when set. It is easy to work with and has excellent memory if splints need to be remade or adjusted.

18" x 24" Sheets, 4/case

1/8"	1005757	\$271.99 cs.
3/32"	1005758	\$256.99 cs.
1/16"	1005756	\$221.99 cs.



THERM-O-FOAM™ Padding Kit

Soft enough to be a legal playing pad, and it's heat formable. Provides low-cost protection. Trim to size and mold to body. THERM-O-FOAM can be reformed for reuse and also can be used for insoles. NOT microwavable.

(10) 14" x 19" Superlite Sheets: (2) 1/16", (2) 1/4", (2) 3/8", (2) 1/2", (2) 5/8"	
(4) 12 1/2" x 16 5/8" Lite Sheets: (2) 1/16", (2) 3/8"	
14 Sheets/kit	29022 \$234.99 kit



Orfit Thermoplastic Casting Tape

Orficast is a unique thermoplastic knitted fabric casting tape that eliminates all of the issues and difficulties routinely experienced with the traditional plaster and fiberglass casting materials.

- Fast, easy to use, breathable, versatile and comfortable casting, and splinting
- The perfect quick wrap for finger, wrist, thumb, and toes injuries
- Small Immobilization casts, Fractures, PIP Flexion Contractures, Mallet injuries of fingers, Trauma/TIP Injuries, and all common sports injuries
- Activated in hot water (140–60 degrees F) in hydrocollator or by 1 minute in a microwave
- When activated, wrap around an injured body part and quickly form a cast
- Becomes rigid like plaster, but without the mess
- Remove by sliding off or cutting off with plaster scissors

1 1/8" x 9.8'	29525	\$34.99 roll
2 1/4" x 9.8'	29526	\$52.99 roll



3M™ Scotchcast™ One-Step Splints

Multiple layers of a knitted fiberglass fabric, infused with polyurethane resin that is pre-padded with foam. One-Step Splints are pre-cut and individually pouched. More portable and faster to apply than roll splints.

2" x 10"	20076	\$15.99 ea.
3" x 12"	20077	\$18.99 ea.

Podiatry Products



Econoline Turfliner Insoles

“Turf-Toe” is a sprained or hyper-extended toe caused by bending the toe backwards, stretching or straining the ligaments. Stiff-soled shoes help to prevent injuries.

Econoline’s Turfliner is a lightweight, flexible neoprene shoe liner with a special spring steel plate. Available with half steel insert or full steel insert. Order by shoe size.

Shoe Size	Men's		Women's	
	Half-Steel	Full-Steel	Half-Steel	Full-Steel
6	—	—	27220	27215
7	27206	27197	27221	27216
8	27207	27198	27222	27217
9	27208	27199	27223	27218
10	27209	27200	27224	27219
11	27210	27201	—	—
12	27211	27202	—	—
13	27212	27203	—	—
14	27213	27204	—	—
15	27214	27205	—	—

All Half-Steel Insole Sizes\$26.90 pr.
 All Full-Steel Insole Sizes\$44.40 pr.



Carbon Fiber Inserts

Over two times lighter and more rigid than steel inserts. Used for any foot condition requiring rigid, mid-foot support of the foot: mid-foot sprains, turf toe, metatarsal fractures/stress fractures, lis franc injuries, and post-op or post injury transition from boot to shoe. Should be taped or light adhesive applied to sock liner or orthotic to prevent moving in shoe. Fits right or left foot. All sizes sold individually, not as a pair.

		Shoe Size	
Men's	Women's	Semi-Rigid	Rigid
6	7	27456	27469
7	8	27457	27470
8	9	27458	27471
9	10	27459	27472
10	11	27460	27473
11	12	27461	27474
12	—	27462	27475
13	—	27463	27476
14	—	27464	27477
15	—	27466	27479
16	—	27468	27480
		\$64.99 ea.	\$68.99 ea.



Dr. Jill's Carbon Stabilizer Plates

Dr. Jill’s extremely thin plates (1/8” thick) are constructed to limit dorsiflexion at the MP joints. Designed to stiffen the sole of the shoe and limit the range of motion of the forefoot and midfoot to make the shoe non-flexible, plates allow for a small amount of flex to enable forefoot roll-off, toe-off.

Shoe Size	Men's		Women's	
	Semi-Rigid	Extra-Rigid	Semi-Rigid	Extra-Rigid
5	—	—	1007971	—
6	1007778	—	1007784	1007800
7	1007779	1007794	1007785	1007801
8	1007780	1007795	1007786	1007802
9	1007914	1007796	1007787	1007803
10	1007772	1007788	1007781	1007797
11	1007773	1007789	1007782	1007798
12	1007774	1007790	1007783	1007799
13	1007775	1007791	—	—
14	1007776	1007792	—	—
15	1007777	1007793	—	—

All Sizes, Semi-Rigid, Sold as Pairs\$45.25 pr.
 All Sizes, Rigid, Sold as Pairs\$56.50 pr.

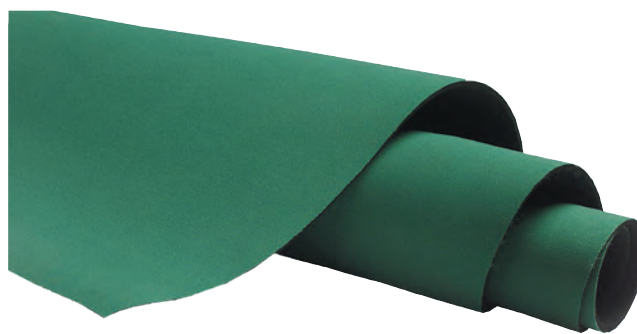

Spenco® Bulk Insole Material

Enough material to cut approximately 22 to 24 pairs of insoles. Color: Green.
 42" x 45" x 1/8" roll27072 \$104.99 roll



Sole Orthopedic Insole

A 1.6 mm layer of cushioning is added to the mouldable EVA base layer and topped off with a moisture-wicking top sheet. These footbeds offer minimal cushioning, optimized to fit in most athletic shoes and making it the best option for a diverse array of activities.

- A.** Active Med—Regular
- B.** Performance Med—Added perforated ventilation
- C.** Active Thin—Designed for tight-fitting shoes

Size	Active Med	Performance Med	Active Thin
W7/M5	1003516	1003504	1003528
W8/M6	1003517	1003505	1003529
W9/M7	1003518	1003506	1003530
W10/M8	1003519	1003507	1003531
W11/M9	1003520	1003508	1003532
W12/M10	1003521	1003509	1003533
W13/M11	1003522	1003510	1003534
W14/M12	1003523	1003511	1003535
M13	1003524	1003512	1003536
M14	1003525	1003513	1003537
M15	1003526	1003514	1003538
M16	1003527	1003515	1003539
	\$52.99 pr.	\$63.40 pr.	\$51.99 pr.



D. Spenco RX® Comfort Insoles

Slim fit shoe liner for lasting cushioning and heel-to-toe comfort. Helps reduce friction and shear. Lightweight, washable, trim to fit with scissors. Unconditionally guaranteed for one full year.

E. Spenco RX® Orthotic Arch Supports

Heat moldable for a custom fit. Spenco material absorbs shock and reduces friction to improve overall foot comfort. Unconditionally guaranteed for one full year.

Order by Shoe Size			
Men's	Women's	Insoles	Arch Supports
—	5-6	27069	27126
6-7	7-8	27070	27127
8-9	9-10	27071	27128
10-11	11-12	27067	27129
12-13	—	27068	27130
14-15	—	27125	27131
		\$10.99 pr.	\$27.99 pr.

Insite™ Insoles

Insight precision insoles support the athletes who are constantly pushing the boundaries of their sport. During development, each aspect of the foot was studied, from athlete biomechanics to energy loss and overall performance. The result is an insole that acts more like a high-end orthotic.

F. Pulsion Core—with an FCX shell and pulsion foam technologies to offer increased support and energy transfer and to help keep athletes moving.

G. Fusion Elite—featuring many of the same technologies as the Carbon Pro, the Fusion Elite is Insite's newest addition and utilizes a fusion composite shell.

H. Carbon Pro—the proven choice for professional athletes around the world. The Carbon Pro Insole provides ultra-lightweight support and maximum energy return in all types of athletic footwear.

Size	Pulsion Core	Fusion Elite	Carbon Pro
W7-8.5/ M6-7.5	1006573	1006567	1006561
W9-10.5/ M8-9.5	1006574	1006568	1006562
W11-12.5/ M10-11.5	1006575	1006569	1006563
M12-13.5	1006576	1006570	1006564
M14-15.5	1006577	1006571	1006565
M16-17.5	1006578	1006572	1006566
	\$37.99 pr.	\$64.99 pr.	\$102.99 pr.

Podiatry Products



E



F

A. Pedifix® GelSmart™ Covered Achilles/Dorsum Protection Sleeve

Protection for both the top of the foot and Achilles tendon by reducing pressure, shear forces, and friction from boots/skates. Protects from abrasions caused by athletic footwear, without adding bulk.

Small27509 \$22.99 ea.
Large27510 \$22.99 ea.

B. Pedifix® GelSmart™ Achilles Covered Pad

Ideal for fatigued or injured Achilles tendon. Soft, comfortable gel pad protects the posterior of the heel from friction, while gently compressing and reducing pressure.

Small/Medium27504 \$21.99 ea.
Large/X-Large27505 \$21.99 ea.

C. Pedifix® GelSmart™ Malleous Pad

Soft, comfortable pad provides gentle compression around ankle bones, while reducing abrasion and shear forces over the ankle.

One Size27506 \$21.99 ea.

D. Pedifix® GelSmart™ Covered Dorsum Protection Sleeve

Protection from top of foot to the skin by reducing pressure, shear forces, and friction. Used as an interface between foot and shoe.

Small/Medium27507 \$21.99 ea.
Large/X-Large27508 \$21.99 ea.

E. Pedifix® GelSmart™ Toe Separators

Designed for standard footwear to minimize toe pressure and reduce friction and irritation between toes.

Large, 15/pkg27481 \$17.99 pkg.
X-Large, 15/pkg27482 \$17.99 pkg.

F. Pedifix® GelSmart™ Toe Spacers

For straightening and aligning toes and relieving pressure from bunions. Vitamin-enriched gel cushions and protects skin. Washable and reusable.

Medium, 4/pkg27483 \$6.99 pkg.
Large, 4/pkg27484 \$6.99 pkg.



E



F

A. Silipos® Skate Bite Protecto

A great pad for hockey players, figure skaters, runners, and roller-bladers to prevent laces from digging into the top of their feet.

.....41694 \$25.99 ea.

B. Silipos® Achilles Heel Pad™

Recommended by medical professionals for people with Achilles tendonitis, bursitis, heel prominences, pump bumps, and hardened skin. Washable and reusable.

Small/Medium29342 \$26.99 ea.
Large/X-Large29343 \$26.99 ea.

C. Silipos® ProSport Boot Bumper

Conforming polymer gel pads protect the front and back of the ankle from pressure, pinching, and friction. Irritation, burning, and redness are reduced by the unique properties of the Silipos® gel.

Small/Medium41674 \$29.99 ea.
Large/X-Large41675 \$29.99 ea.

D. Silipos® Malleolar Gel Sleeve™

Two soft polymer gel pads are molded into the elastic sleeve to moisturize skin and protect the ankle from abrasion, friction, shear, chafing, and callus formation. Reduces swelling. Washable and reusable.

One Size29344 \$26.99 ea.

E. Silipos® Gel-E-Roll

May be used to reduce scar tissue, for cold therapy, to provide compression, as a residual limb shrinker, to aid in muscle strains or arthritic pain, to moisturize areas of dry skin, for burn care, and to help control edema.

4" x 48"27655 \$27.99 roll

F. Silipos® Gel Metatarsal Pad with Toe Spreader

Size	Men's Shoe	Women's Shoe	Item #
Medium	5-6	6½-7½	29377
Large/X-Large	6½-12	8-13	29378
All Sizes			\$11.99 pr.



Silipos® Pre/Post Wound & Burn Care Kit

Versatile carrying kit with all Silipos' key items included in this unique package. Indications: Skin breakdown, ulcers, turf abrasions, blisters, pressure relief. Gel moves independently, so it will not cause friction like silicone.

Includes:

- | | | |
|--------------------------------|---------------------------|--------------------------------------------|
| (8) Small mesh digital caps | (6) XX-large digital caps | (2) 4" Body Discs |
| (6) Mini digital caps | (1) 3/4" x 6" mesh tubing | (1) 4" x 48" Gel E Roll |
| (6) Small/medium digital caps | (1) 3" x 10" mesh tubing | (1) 4" x 10' Roll 1/2 coated body sleeving |
| (6) Large/X-large digital caps | (2) 3/4" x 6" DigiTube | (1) Re-order card |
| | (2) 1" x 6" DigiTube | |
| | (2) 2.5" Body Discs | |
-27585 \$267.99 kit



Silipos® Digital™ Care Kit

Leading-edge gel products in one convenient kit.

Contents:

- (12) Digital Pads™, four Mini, four S/M, four L/XL
- (6) Digital Caps™ Regular
- (2) Mesh Tubing, 3/4" x 6"
- (8) Gel Toe Spreaders™, four M, four L
- (12) Gel Toe Separators™, six S, six L

.....29338 \$80.99 kit



Silipos® Gel Toe & Antibacterial Gel Toe Spreaders

- Conforms and comfortably fits between toes
- Releases a medical grade mineral oil to lubricate skin as it separates troubled toes
- Larger in size compared to the Gel Toe Separators

• Used as an inter-digital wedge for bunion deformity, overlapping toes, or toe drift

• Hypoallergenic

• Antibacterial Gel Toe Spreaders are proven to kill up to 99.9% of MRSA, E. coli, Trichophyton mentagrophytes, and Trichophyton rubrum

Gel Toe Spreaders, 4/pkg.

Medium29395 \$7.99 pkg.

Large29396 \$7.99 pkg.

Gel Toe Separators, 15/pkg.

Small29397 \$11.99 pkg.

Large29398 \$13.99 pkg.

Antibacterial Gel Toe Spreaders, 6/pkg.

Medium29520 \$9.99 pkg.

Large29521 \$9.99 pkg.



Pedifix® Deluxe Gel Smart Kit

Convenient storage case with separate compartments. Excellent way to store and display popular products

Kit contains:

- | | |
|-------------------------------------------------|---------------------------------------------------|
| (3) Visco-GEL Corn Pads, S/M | (3) Visco-GEL Toe Separators, L |
| (3) Visco-GEL Corn Pads, L/XL | (1) Visco-GEL Ribbed Tube, Narrow |
| (2) Visco-GEL Toe Spacers with Loop, M | (1) Visco-GEL Ribbed Tubes, Wide |
| (2) Visco-GEL Toe Spacers with Loop, L | (2) Visco-GEL Toe Spacer/Bunion Guard |
| (2) Visco-GEL Fabric Covered Digital Caps, S/M | (2) Visco-GEL Bunion Guard, Hallux |
| (2) Visco-GEL Fabric Covered Digital Caps, L/XL | (2) Visco-GEL Bunion Guard, Tailor's |
| (2) Visco-GEL Fabric Covered Digital Caps, XXL | (2) Visco-GEL Hammer Toe Crests |
| (2) Visco-GEL Digital Caps, S/M | (2) Visco-GEL Self-Adhesive Sheeting, 2 1/2" x 3" |
| (2) Visco-GEL Digital Caps, L/XL | (2) Pedi-GEL Ball of Foot Pads |
| (2) Visco-GEL Digital Caps, XXL | (2) Pedi-GEL Arch Pads |
| (3) Visco-GEL Toe Separators, S | (4) Pedi-GEL Callus Pads |
| (3) Visco-GEL Toe Separators, M | |

51 pieces27498 \$227.99 kit



PED G Body Discs

4 mm thick pure M-GEL with Mylar top cover, available with or without pressure-sensitive adhesive. Mineral oil moisturizes skin at point of contact.

4" Round, 2/pkg.....27511 \$20.99 pkg.

With Adhesive27512 \$20.99 pkg.

PED G Dots with Adhesive Backing

Soft formation for anywhere on the body to off-load pressure and absorb shock or shear forces. 3 mm thick pure M-Gel available with pressure-sensitive adhesive backing.

15 Dots/sheet.....27513 \$13.99 ea.

Pedifix® Self-Adhesive Silicone Sheets (Visco-GEL® Moleskin)

Absorb pressure and friction. Anti-microbial fabric top cover for added durability and comfort.

2 1/2" x 3", 10/pkg.....27524 \$45.99 pkg.

2 1/2" x 3", 2/pkg.....27525 \$9.99 pkg.

4" x 6", 1/pkg.....27526 \$9.99 pkg.

Not made with Natural Rubber Latex.

Podiatry Products



A

A. Silipos® Digital Cap with Toe Spreader

- Traditional Digital Cap with added benefit of built-in Gel Toe Spreader
- Fully lined with mineral oil gel for all-around digital protection
- Helps protect against pain caused by pressure and friction
- Comfortable and simple solution for patients suffering from multiple ailments

L/X-Large, 2/pkg.**.27630** \$11.99 pkg.

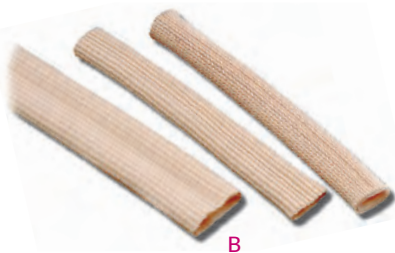

B

B. Silipos® Gel Tubing®

Superior cushioning and protection for painful corns and calluses with gel-lined tubes. Can be trimmed to meet your needs.

¼" x 6", 3/pkg.**.29337** \$20.99 pkg.

3" x 10", 1/pkg.**.29335** \$17.99 pkg.



C

C. Silipos® Digital Pads & Antibacterial Digital Pads

- Protects toes & fingers from discomfort caused by friction & abrasion
- For blebs, blisters, corns, hammer toes, calluses, and digital traumas
- Helps to alleviate footwear pressure on toes
- Hypoallergenic
- Antibacterial digital pads are proven to kill up to 99.9% of MRSA, E. coli, Trichophyton mentagrophytes, and Trichophyton rubrum

Digital Pads, 12/pkg.

Mini.**.29392** \$28.99 pkg.

Small/Medium.**.29336** \$28.99 pkg.

Large/X-Large.**.29334** \$34.99 pkg.

Antibacterial Digital Pads, 6/pkg.

Mini.**.29516** \$20.99 pkg.

Small/Medium.**.29517** \$20.99 pkg.

Large/X-Large.**.29518** \$20.99 pkg.



D

D. Silipos® Digital Caps & Antibacterial Digital Caps

- Fully lined with mineral oil gel for all-around digital protection
- Protect against pain caused by pressure and friction
- Can be used to help treat nail or skin problems due to dryness
- Helps reduce discomfort caused by corns, blisters, and ingrown nails
- Fits toes or fingers (average cap length is 2½"/6.5 cm) and can be cut to size
- Hypoallergenic
- Antibacterial digital caps are proven to kill up to 99.9% of MRSA, E. coli, Trichophyton mentagrophytes, and Trichophyton rubrum

Digital Caps, Small/Medium, 6/pkg.

.**.29393** \$31.99 pkg.

Antibacterial Digital Caps,

Small/Medium, 6/pkg.**.29519** \$24.99 pkg.



A

A. Pedifix® GelSmart™ All-Gel Toe/Finger Tubes

Provides protection and comfort for corns, hammer toes, keratotic lesions, and partially amputated digits. Trimmable, washable, and reusable.

10/pkg.

Medium**.27485** \$28.99 pkg.

Large**.27486** \$28.99 pkg.



B

B. Pedifix® GelSmart™ All-Gel Toe/Finger Caps

10/pkg.

X-Large**.27487** \$49.99 pkg.

XX-Large**.27488** \$55.99 pkg.



C

C. Pedifix® GelSmart™ Digital Cap

Seamless knit, optimal toe/finger protection. Fully coated with soft, medical-grade, vitamin-enriched mineral oil gel to help improve appearance of old and new scars. Caps can be trimmed, washed, and reused.

6/pkg.

Large/X-Large**.27489** \$36.99 pkg.

XX-Large**.27490** \$39.99 pkg.



D

D. Pedifix® GelSmart™ Fully-Coated Digital Tubes

Fully lined with vitamin-enriched gel. Relieves pain from corns, calluses, nail problems, dry cuticles, and abrasions. Washable and reusable. Can be easily cut to fit any size required.

6/pkg.

Narrow**.27495** \$19.99 pkg.

Wide**.27496** \$19.99 pkg.



E

E. Pedifix® GelSmart™ Corn Pads

For protecting toes or fingers. Medical-grade mineral oil releases comfortably on contact with the skin to soften corns and calluses. Washable and reusable.

12/pkg.

Small/Medium.**.27491** \$27.99 pkg.

Large/X-Large.**.27492** \$30.99 pkg.



F

F. Pedifix® GelSmart™ Digital Pads

Thicker, rounder-shaped gel padding for increased cushioning and comfort. Stretchable, slip-on device helps relieve pain from corns, blisters, hammer toes, calluses and digital trauma. Washable and reusable.

24" Strip, 2/pkg.

Small/Medium.**.27493** \$29.99 pkg.

Large/X-Large.**.27494** \$34.99 pkg.

Not made with Natural Rubber Latex.

Heel Cups & Blister Care



A. Spenco RX® Heel Cushions

Thick, soft pads help relieve pressure and protect the heel from impact and stress. Unconditionally guaranteed for one full year.

Small	27281	\$8.99 pr.
Medium	27282	\$8.99 pr.
Large	27283	\$8.99 pr.

B. Silipos® WonderSpur

Aids in calcaneal spurs, plantar fasciitis, heel spurs, and knee and back pain. Large fits men's 8-10 and women's 10-12, X-Large fits men's 11+ and women's 12+

Large	27666	\$21.99 pr.
X-Large	27669	\$21.99 pr.

C. Silipos® WonderCup

Relieves pain throughout heel. Aids in bursitis, Achilles tendonitis, pressure ulcers, and plantar fasciitis. Dual density orthotics provides maximum support and shock absorption. Clear silicone construction with an insert provides relief to sensitive areas. Large fits men's 8-10 and women's 10-12, X-Large fits men's 11+ and women's 12+

Large	27662	\$21.99 pr.
X-Large	27665	\$21.99 pr.

D. Spenco® Gel Heel Cups

Dual density gel that absorbs impact and shock. Provides advanced cushioning for sensitive or sore heels. Reinforced cupping enhances shock absorption and support.

Small/Medium	27441	\$9.99 pr.
Medium/Large	27442	\$9.99 pr.



A. Pinch Pads

Soft and resilient felt pads are placed on the surface of the shoe's upper break to take up slack and prevent pinching in the vamp area.

Medium, 36/box	29471	\$35.99 box
----------------------	--------------	-------------

B. Spenco® Aquaheal

- Proven hydrogel technology with clear adhesive seal
- Water resistant
- Soothes, protects, & promotes faster healing
- Keeps bacteria out
- Highly absorbent

(3) 1" x 2.2" & (3) 1.73" x 2.9", 6/box	27606	\$13.99 box
1" x 2.2", 25/box	27607	\$30.99 box
1.73" x 2.9", 25/box	27608	\$39.99 box

Mueller® Heel Cups

Relieves arch, ankle, leg, and back pain. Helps prevent sore heels and knees, shin splints and heel spurs. Standard Cups provide lightweight protection for the everyday pain of heel strike. Pro Cups provide heavy duty protection for the pain of heel strike during sports activities. Regular (under 175 lbs.) or Large (over 175 lbs.).

1 pair of 2 cups/package

E. Standard Regular	27563	\$11.99 pkg.
Standard Large	27564	\$11.99 pkg.
F. Pro Regular	27565	\$11.99 pkg.
Pro Large	27566	\$11.99 pkg.

G. Heavy-Duty Gel Heel Cup

Waffle design provides the ultimate in shock and vibration absorption. Relieves painful heel conditions, aching feet, sore joints and shin splints. Large size for people over 175 pounds.

Regular	41872	\$16.99 pr.
Large	41873	\$16.99 pr.

Classic Gel Heel Cup

Large size for people over 175 pounds.

Regular	41863	\$15.99 pr.
Large	41864	\$15.99 pr.



C. Spenco® Blister Kit

Convenient protection, prevention and relief from friction, pressure and blisters. Kit contains (6) 3" x 1 1/2" and (1) 3" x 5" Adhesive Knit, (6) 1" squares 2nd SKIN® Dressing and (1) 3" x 5" sheet of Pressure Pad ovals. Keep one in your backpack, tool box, car glove compartment or at home. Single pack.

Assorted	27063	\$10.35 kit
----------------	--------------	-------------

D. Spenco® Adhesive Knit

Sheets of adhesive tape developed especially for hands and feet. Made from a highly breathable non-woven fabric with the ability to stretch, conform and not sweat or bathe off. Helps reduce friction and reduce calluses and blisters. Great for holding 2nd SKIN® Dressing in place. Cut to any size or shape.

3" x 5", 6/box	29062	\$9.27 box
----------------------	--------------	------------

Blister Care



A



B



C



D



E



F



G

A. Spenco® 2nd Skin Dressing

Cools and soothes on contact to help protect against blisters, pressure, and friction. Helps relieve stings, bites, poison ivy, and blisters.

Non-Sterile

3" x 6½", 2/pkg.27062 \$11.99 pkg.

2" Squares, 200/jar27060 \$33.99 jar

3" Circles, 48/jar.27061 \$51.19 jar

Sterile

3" x 4", 3/pkg.27119 \$9.99 pkg.

2" x 3", 4/box27120 \$9.99 box

1½" x 2", 6/box.27121 \$9.99 box

B. Cramer® Blister Foam

Blister Foam is a cushioned, self-adhesive foam pad used to prevent blister-causing friction. It is thin and flexible, so it conforms easily to any skin surface.

25/box27196 \$35.99 box

C. BlisterShield Blister Prevention Powder

BlisterShield's advanced technology provides unsurpassed resistance to blisters and related skin irritation and discomfort. Ideal for breaking-in new sports shoes, inside gloves, medically related blisters, wet weather activities, mild to extreme conditions. Perfect for feet, hands, and butt.

Single Use Packets

10/pkg.27583 \$16.99 pkg.

48/box27584 \$70.99 box

8 oz. Resealable Pouch27581 \$16.99 ea.

32 oz. Tub.27582 \$43.99 ea.

D. ENGO™ Blister Prevention Patches

Apply to footwear and equipment, NOT the skin. Eliminates rubbing in targeted locations and makes everyday taping and bandage application unnecessary. Adhesive backing applies to inside of footwear in areas where heat, rubbing, and moisture cause blisters.

Large Ovals, 30/pkg.27311 \$72.99 pkg.

Small Ovals, 30/pkg.27310 \$66.99 pkg.

Rectangles, 3" x 4", 15/pkg.27309 \$75.99 pkg.

E. Mueller® More Skin®

Protects and helps prevent blisters; soothes abrasions, cuts, and scratches. Hydrogel wound dressing provides moisture for healing, absorbs wound secretions, and helps protect against contamination. Cut to desired shape and size. Won't stick!

12" x 12"27291 \$28.45 ea.

1" x 1", 75/foil packs.27528 \$31.99 box

3" Circles, 25/foil packs27527 \$58.99 box

F. Cramer® Blister Derm™ Anti-Friction Pads

Blister Derm Pads™ help protect from blisters and hot spots. The glycerin-based gel is thin enough for comfort and thick enough for protection. Won't dry out, so one pad outlasts the blister.

3" Circles, 20/jar.27182 \$75.99 jar

G. Chafezone

A quick swipe of ChafeZone banishes chafing, discomfort from running, riding, hiking, cycling, dancing, body armor, heavy packs, or new footwear. Long lasting, easy to apply, and durable make ChafeZone a great alternative to prevent, chafe, chub rub, and other skin irritations related to friction.

1.5 oz. 1006610 \$19.05 ea.

NEW!



Wuru Wool

Protect your feet with Wuru and walk away from discomfort. Wuru is ideal for absorbing moisture, reducing friction, preventing blisters, promoting breathability, and providing cushioning.

Wuru is made from 100% New Zealand wool that has been specially washed and finely combed into a soft, fluffy fleece. Simply apply to the soles of your feet, between your toes, or any other areas you want to protect.

Wool's natural properties perform wonders, providing cushioning, absorbing moisture, reducing friction, preventing blisters, and promoting breathability. This makes Wuru perfect for hiking, running, cycling, skiing, team sports, and other active endeavors.

0.75 oz. 1034602 \$10.95 ea.

Wound & Infection



Theraworx..... 94

Adhesive Bandages.....	72
Advanced Wound Care & Skin Closures	73-74
Gauze, Sponges, & Bandages	75-78
Cotton Balls, Rolls, & Applicators	79
Bleeding Control	80
Exam Gloves.....	81-83

Hand Sanitizers & Hand Soaps	89-91
Antibacterial Soap.....	92
Antibacterial Skin Care.....	93
Skin Care, Prep Pads & Masks.....	94
Clean-Up Products	95
Infectious Waste Disposal & Sharps Containers	96



SCHOOL HEALTH BRAND

- Maximum conformability and flexibility for greater comfort
- Breathable and durable protection
- Premium adhesive stays secure even under the most active conditions
- All SH Brand bandages and packaging are not made with natural rubber latex



Island pad with 360° of adhesive protects the wound from germs and dirt with a four-sided seal

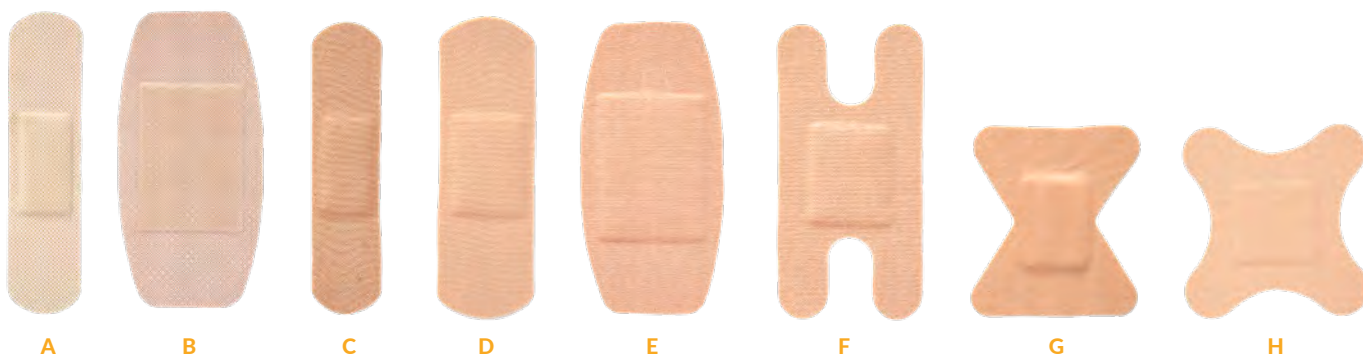

Flexible Fabric

Woven to stretch, bend and breath for durable, high-quality protection.

	1-23 Boxes	Case of 24
C. ¾" x 3"		
100/box ... 32005	\$3.76 box	\$3.38 box
750/box ... 32072	\$25.75 box	—
1,500/box ... 32073	\$42.65 box	—
D. 1" x 3"		
100/box ... 32006	\$4.28 box	\$3.85 box
750/box ... 32075	\$30.10 box	—
1,500/box ... 32076	\$51.15 box	—
E. Extra Large, 2" x 4"		
50/box ... 32120	\$7.01 box	\$6.31 box
F. Knuckle, 1½" x 3"		
100/box ... 32230	\$7.07 box	\$6.36 box
G. Fingertip, 1¼" x 2"		
100/box ... 32231	\$7.88 box	\$7.09 box
H. 4-Wing, 3" x 3"		
50/box ... 32265	\$7.67 box	\$6.90 box

Plastic

Cost effective and comfortable for everyday wound protection.

	1-23 Boxes	Case of 24
I. ¾" x 3"		
100/box ... 32001	\$3.10 box	\$2.79 box
750/box ... 32045	\$19.80 box	—
1,500/box ... 32070	\$35.20 box	—
J. 1" x 3"		
100/box ... 32000	\$3.10 box	\$2.79 box
750/box ... 32046	\$24.35 box	—
1,500/box ... 32071	\$42.45 box	—
K. Junior, ¾" x 1½"		
100/box ... 32241	\$2.81 box	\$2.53 box
50/box ... 32044	\$5.11 box	\$4.60 box
L. Patches, 1½" x 1½"		
100/box ... 32043	\$5.18 box	\$4.66 box
M. Spots, ¾" Diameter		
100/box ... 32042	\$3.03 box	\$2.73 box
Plastic Assorted Pack		
(20) 1" x 3", (30) ¾" x 3", (20) ¾" x 1½", (10) Spots ¾" Diameter		
80/box ... 32033	\$2.92 box	\$2.63 box

Sheer

These bandages blend with the skin for more discreet coverage.

	1-23 Boxes	Case of 24
A. ¾" x 3"		
100/box .. 32029	\$2.95 box	\$2.66 box
750/box .. 32047	\$20.90 box	—
1,500/box 32036	\$35.35 box	—
1" x 3"		
100/box .. 32028	\$3.42 box	\$3.08 box
750/box .. 32048	\$23.30 box	—
1,500/box 32037	\$43.15 box	—
B. Extra Large Sheer Strips, 2" x 4"		
50/box ... 32251	\$5.38 box	\$4.84 box

Not made with Natural Rubber Latex.

ADHESIVE BANDAGES

School Health Brand Sensitive Skin, Flexible Fabric Adhesive Bandage

The next generation of School Health Adhesive Bandages is here!! These flexible fabric adhesive bandages are designed specifically for sensitive or fragile skin, while also providing a more absorbent wound pad for increased protection around the area of the cut/wound.

- Designed for sensitive and/or fragile skin
- Advanced silicone adhesive allows for breathability and pain-free removal
- Highly absorbent, non-adherent wound pad
- Hypoallergenic and comfortable flexible fabric
- Easy on/off

3/4" x 3", 50/box	1031998	\$8.75 box
1 1/2" x 4", 25/box	1031999	\$9.95 box



- Gently protects
- Pain-free removal

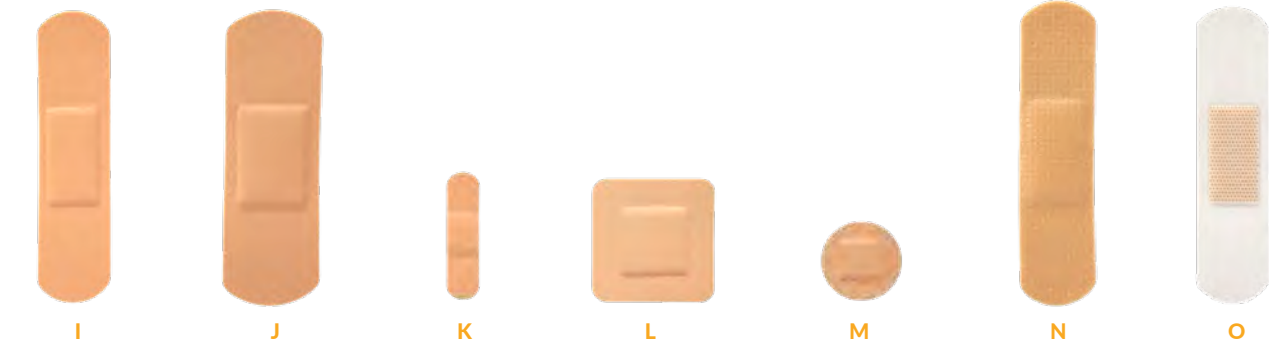

Foam Strips

Cushioned foam bandage offers maximum comfortability and flexibility that is easy to wear and water resistant.

	1-23 Boxes	Case of 24
N. 3/4" x 3"		
100/box ... 32181	\$6.88 box	\$6.19 box
1" x 3"		
100/box ... 32182	\$8.59 box	\$7.73 box



Clear

Offers subtle, transparent coverage for a discreet look while keeping wounds protected.

	1-23 Boxes	Case of 24
O. 3/4" x 3"		
100/box ... 32183	\$3.73 box	\$3.36 box
1" x 3"		
100/box ... 32184	\$4.57 box	\$4.11 box



Butterfly Closures

Wound closures secure wounds and help keep them closed in the early stages of healing.

	1-23 Boxes	Case of 24
3/8" x 1 3/4"		
100/box ... 32279	\$6.32 box	—



School Health Brand Adhesive Bandage Cabinet

Our 18 drawer cabinet is ideal for organizing and consolidating supplies in a small area. Easy-to-open drawers are removable to simplify refilling. It's the perfect size for countertops, medical shelving, or desks and can also be mounted to the wall. Available filled or empty. Includes additional set of blank labels. Each drawer is clearly labeled with the type of bandage. Drawers measure 4 1/2" W x 2 1/2" H x 5 1/2" D.

The following bandages are included with the filled cabinet:

- | | | |
|------------------------------------------------|--------------------------------------|-----------------------------------|
| (1) Box 7/8" plastic spot | (1) Box 2" x 3" fabric patch | (2) Boxes 2" x 4" fabric strips |
| (1) Box 1 3/4" x 2" fabric fingertip | (2) Boxes 3" x 3" fabric 4-wing | (3) Boxes 3/4" x 3" fabric strips |
| (1) Box 3/8" x 1 3/4" fabric butterfly closure | (2) Boxes 1 1/2" x 3" fabric knuckle | (3) Boxes 1" x 3" fabric strips |
| (2) Boxes 1 1/2" x 1 1/2" plastic patch | | |

14 7/8" W x 18 1/2" H x 6 5/8" D		
Filled	1006538	\$110.00 set
Empty	1006060	\$56.60 ea.
Refill Bandages	1006535	\$61.65 set

Not made with Natural Rubber Latex.

Adhesive Bandages

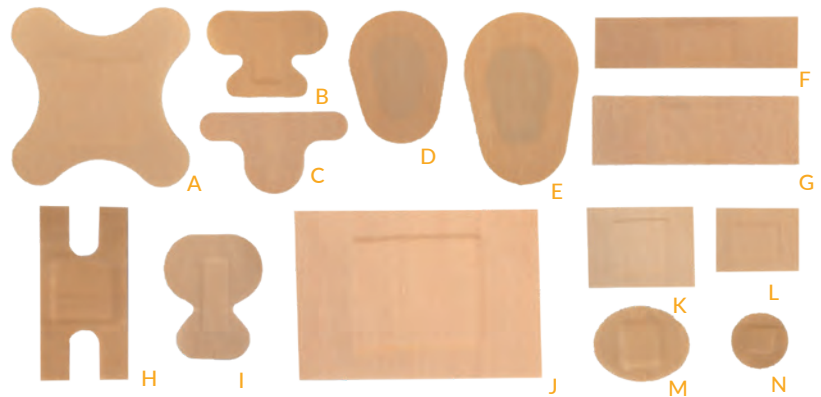

Coverlet® Cabinet

Cabinet has 18-drawers and holds 18 boxes of Coverlet® Adhesive Bandages. Drawers are removable for simple refilling. Available empty or filled (labels included with both). Can be mounted on wall.

14⁷/₈"W x 18¹/₂"H x 6³/₈"D

Filled **90783** \$125.50 set

Coverlet® Adhesive Bandages

Stretchable and form-fitting for hard-to-fit places. Breathable and adheres to skin. Stretches without breaking the seal.

A. 4-Wing

3" x 3" (0385), 50/box.....**32022** \$17.05 box

B. Small Digit/Fingertip

2" x 1½" (1306), 100/box**32020** \$14.60 box

C. Toe Shield (no pad)

2½" x 1¾" (0801), 100/box.....**32024** \$12.90 box

Eye Occlusor

D. Junior Size (46429), 20/box**32055** \$9.87 box

E. Regular Size (46430), 20/box.....**32058** \$10.35 box

F. ¾" Strip

¾" x 3" (0230), 100/box**32217** \$5.65 box

¾" x 3", 8,100/case.....**32074** \$470.50 cs.

G. 1" Strip

1" x 3" (0231), 100/box.....**32219** \$6.68 box

1" x 3", 7,200/case**32077** \$349.99 cs.

H. Knuckle

1½" x 3" (1390), 100/box**32023** \$14.00 box

I. Large Digit/Fingertip

2" x 2½" (1307), 50/box**32018** \$13.30 box

J. Extra-Large Patch

2¾" x 4", 50/box**32280** \$14.80 box

K. Large Patch

2" x 3" (0340), 50/box.....**32021** \$10.80 box

L. Small Patch

1½" x 2" (0330), 100/box**32060** \$13.55 box

M. Oval

1¼" (0303), 100/box**32062** \$8.69 box

N. Round

¾" (0301), 100/box.....**32061** \$7.70 box

Coverlet® Adhesive Bandages – BULK

¾" x 3"	1" x 3"
100/box	100/box
..... 32217 \$5.65 box 32219 \$6.68 box
750/box	750/box
..... 32188 \$40.49 box 32187 \$50.02 box
1,500/box	1,500/box
..... 32186 \$79.00 box 32185 \$98.06 box
8,100/case	7,200/case
..... 32074 \$470.50 cs. 32077 \$349.99 cs.

Buy in Bulk and SAVE!

HARTMANN Flex-Band® Adhesive Bandages



Ideal for dressing minor injuries and as a bandage for sensitive skin. Made with hypoallergenic adhesive, the full coverage around the wound pad firmly secures the bandage while providing a protective seal that won't irritate the skin. Removes painlessly, without leaving a sticky residue.

4-Wing, 3" x 3", 50/box 32144	\$13.75 box
Spot (Round), ¾", 100/box..... 32145	\$5.54 box
Patch, 2" x 3", 50/box 32147	\$6.76 box
Oval, 1¼" x 1", 100/box..... 32149	\$5.93 box
Large Digit, 2" x 2½", 50/box..... 32153	\$5.96 box
Knuckle, 100/box..... 32148	\$9.38 box
Small Digit, 2" x 1½", 100/box..... 32152	\$7.98 box
Strips, ¾" x 3", 100/box 32150	\$5.81 box
Strips, 1" x 3", 100/box..... 32151	\$6.05 box

 Not made with Natural Rubber Latex.

Advanced Wound Care & Skin Closures



3M™ Steri-Strips

Made of porous, non-woven material. Reinforced with filaments for strength and coated with a hypoallergenic adhesive. Designed to permit skin ventilation.

1/8" x 3"		
50/pkg.	.28138	\$22.85 pkg.
250/box	.28136	\$91.70 box
1/4" x 3"		
30/pkg.	.28139	\$22.85 pkg.
150/box	.28137	\$91.70 box
1/2" x 4		
300/box	.28272	\$142.99 box



Leukostrips

Fine strips of reinforced adhesive designed to replace sutures as wound closures. Sterile.

1/8" x 1 1/2"		
80/pkg.	.28394	\$23.69 pkg.
400/pkg.	.28393	\$101.00 pkg.
1/4" x 3"		
30/pkg.	.28396	\$23.69 pkg.
150/pkg.	.28395	\$101.00 pkg.



Economy Wound Closure Strips

Made of flexible, nonwoven material with skin-friendly adhesive.

1/8" x 3", 50 pkg./5's		
250 Strips.	.28407	\$67.15 pkg.
1/8" x 3", 1 Pack		
5 Strips	.28408	\$1.58 pkg.
1/4" x 3", 50 pkg./3's		
150 Strips.	.28409	\$67.15 pkg.
1/4" x 3", 1 Pack		
3 Strips	.28410	\$1.58 pkg.
1/4" x 1 1/2", 50 pkg./6's		
300 Strips.	.28411	\$67.15 pkg.
1/4" x 1 1/2", 1 Pack		
6 Strips	.28412	\$1.58 pkg.



A



B



C



D



E

A. Marathon Liquid Skin Protectant

Bonds to the skin surface and provides higher strength and higher resistance to wash off than other thin film barriers. It is resistant to external moisture, but allows skin to breathe, minimizes friction, and reduces the risk of developing skin tears.

.5g, 10/box.	.34639	\$110.00 box
--------------	--------	--------------

B. Dermabond Wound Care

A topical skin adhesive with a unique formulation proven to create a protective barrier that adds strength and inhibits bacteria. Clinically shown to provide wound-holding strength in minutes and provides a flexible microbial barrier with 99% protection for 72 hours!

Mini, .36 mL, 12/box.	.55811	\$39.50 box
Advanced, .7 mL, 1/ea.	.1005675	\$68.10 ea.

C. Medique® Liquid Skin® Bandage Alternative

A 100% waterproof bandage that stays on hard-to-cover areas! Easy-to-apply, sting-free liquid bandage forms a breathable, protective layer that promotes healing and helps prevent infection by reducing exposure to dirt and germs.

0.5 g, 10/box.	.1006096	\$16.80 box
----------------	----------	-------------

D. SilvaSorb Antimicrobial Gel

Provides targeted antimicrobial protection for every type of wound. SilvaSorb kills microbes, but is completely biocompatible with the tissue cells of healing. SilvaSorb will not dry out a wound or macerate the surrounding skin.

16 oz. Jar	.43346	\$248.50 ea.
8 oz. Tube	.43347	\$142.00 ea.
3 oz. Tube	.43348	\$50.60 ea.
1.5 oz. Tube	.43349	\$52.30 ea.
.25 oz. Tube	.43350	\$15.90 ea.

E. Histoacryl® Tissue Seal

FDA approved Histoacryl topical skin adhesive is the proven choice for wound closure. Each ampoule is sealed within a plastic vial so the exterior of the ampoule can remain sterile.

Clear	.49139	\$55.00 ea.
-------	--------	-------------

Not made with Natural Rubber Latex.

HydroTac[®] transparent the multi-purpose hydrogel dressing



Transparent for
visual inspection
of the wound

NEW
**HydroTac[®] transparent and
HydroTac[®] transparent Comfort**

- Hydrogel wound pad protects and donates moisture to the wound
- Hydrogel wound pad does not stick to the wound
- The hydrogel is cool to the touch allowing for less pain during application and provides a soothing effect
- Strong adhesive on bordered version stays in place in moist environments

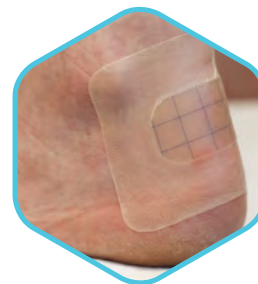

Heel with
HydroTac transparent
Comfort dressing.

4" x 4", 10/box	1034891	\$34.68 box
Comfort, 5" x 5", 10/box	1034895	\$28.23 box

A



A. 3M[™] Tegaderm[™]

Its transparency makes monitoring the healing process easier. Use this dressing to protect post-surgical incisions and minor wounds, cuts, scrapes, burns, or blisters.

4" x 4¾", 50/box	32170	\$138.00 box
2¾" x 2¾", 100/box	32171	\$85.10 box
6" x 8", 10/box	32262	\$63.45 box
8" x 12", 10/box	32263	\$84.65 box

B



B. 3M[™] Tegaderm[™] Hydrocolloid Dressing 

Sterile wound dressings which consist of a hydrocolloid adhesive with an outer clear adhesive cover film impermeable to liquids, bacteria, and viruses.

Square, 4" x 4", 5/box	32301	\$39.30 box
Oval, 4" x 4¾", 5/box	32302	\$52.80 box

C



C. 3M[™] Tegaderm[™] HP Transparent Film Dressing 

Transparent film dressings designed for protecting skin and wound sites. Frame style allows customization of shape and size to fit any site. Unique sacral shape is designed for challenging and difficult-to-dress areas.

4" x 4½", 50/box	32303	\$159.50 box
2¾" x 2¾", 100/box	32304	\$99.80 box

 Not made with Natural Rubber Latex.



A. *SH* School Health Brand Non-Sterile, Rolled Gauze

This 100% crimped cotton woven bandage is ideal for a secondary dressing to secure IVs, dressings, splints, or providing mild compression. The bandage provides cushioning and a light stretch, which helps it to conform to difficult body contours.

	Compare to Dukal®	
12/bag		
2" x 3.5 yds.....	27545	\$3.90 bag
3" x 4.1 yds.....	27546	\$5.66 bag
4" x 4.1 yds.....	27547	\$6.77 bag
6/bag		
6" x 4.5 yds.....	27548	\$6.22 bag

B. *SH* School Health Brand Non-Sterile, Conforming Rolled Gauze

This premier quality bandage gently secures to any body contour without restriction of movement and accommodates an increase or decrease in swelling. The uniquely constructed weave and finished edges help eliminate unraveling and lint. The combination of rayon and polyester help the bandage to provide stretch memory when applied. It's a patient-safe dressing that renders a neat application each time. Ideal for secondary dressing applications.

	Compare to Dukal®	
12/bag		
2".....	27551	\$4.48 bag
3".....	27552	\$5.79 bag
4".....	27553	\$6.82 bag

C. *SH* School Health Brand Non-Sterile, Non-Woven Sponges

Compared to traditional cotton gauze, this non-woven sponge produces less lint and is less traumatic to fragile granulating wound tissue because it's virtually non-adherent. It also has significantly faster wicking ability which promotes a healthy healing environment. Discover the perfect balance between strength and absorbency in this rayon/polyester blend gauze.

	Compare to Dukal®	
4-ply		
2" x 2", 200/bag.....	27539	\$2.37 bag
3" x 3", 200/bag.....	27540	\$5.57 bag
4" x 4", 200/bag.....	27541	\$6.40 bag

D. *SH* School Health Brand Gauze Non-Sterile Sponges and Sterile Pads

These 100% cotton sponges and pads are ideal for wound dressings, wound packing, and general wound care. Our strictly controlled manufacturing process assures clean, debris-free packing with folded edges to prevent unraveling.

	Compare to Kendall Curity®	
Non-Sterile Sponge, 200/bag		
8-ply		
2" x 2".....	27536	\$2.81 bag
3" x 3".....	27537	\$5.41 bag
4" x 4".....	27538	\$7.59 bag
12-ply		
2" x 2".....	27535	\$3.01 bag
3" x 3".....	27534	\$5.79 bag
4" x 4".....	27533	\$8.32 bag

Sterile Pad, 100/box

12-ply		
2" x 2".....	27542	\$6.06 box
3" x 3".....	27543	\$7.51 box
4" x 4".....	27544	\$10.65 box

E. *SH* School Health Brand Sterile Adherent Pads

Non-stick pads are wound covers for post-surgical wounds, lightly bleeding and draining wounds, large surface cuts, scrapes, and burns. They are made of a soft, perforated film bonded to a highly absorbent and breathable pad. The film is ventilated to allow the wound to breathe and absorb any fluids. Includes adhesive border.

	Compare to Kendall Curity®	
2" x 3"		
100/box.....	27529	\$15.65 box
3" x 4"		
100/box.....	27530	\$24.45 box

F. *SH* School Health Brand Sterile, Non-Adherent Pads

This sterile, absorbent, rayon/polyester pad will not interfere with granulating tissue by sticking to the lightly draining wound. The soft, perforated film allows air to circulate and the absorbent pad allows the fluid to collect. It can easily be cut to fit any shape without separating.

	Compare to Kendall Curity®	
2" x 3"		
100/box.....	27531	\$7.00 box
3" x 4"		
100/box.....	27532	\$13.25 box

Not made with Natural Rubber Latex.

Gauze & Sponges



A. Kendall Curity® Sterile Telfa® Adhesive Pads

2" x 3", 100/box	32008	\$20.20 box
3" x 4", 100/box	32009	\$38.65 box

B. Kendall Curity® Sterile Telfa® Non-Adherent Pads

2" x 3", 100/box	27047	\$17.30 box
3" x 4", 100/box	27048	\$26.05 box

C. Kendall Curity® Multi-Trauma Dressing

Sterile, absorbent first-aid dressing protects abrasions, burns, fractures, and lacerations. Can be used for cervical support.

10" x 2½"	27021	\$4.06 ea.
---------------------	--------------	------------

D. Kendall Kerlix®

Sterile, 6-ply, large elastic gauze bandage can be used with a Multi-Trauma dressing to create a bandage or a wrap.

4½" x 4.1 yds., Stretched	27022	\$4.94 roll
-------------------------------------	--------------	-------------

E. Kendall Curity® Sterile Gauze Pads

12-ply		
2" x 2"		
25/box	27016	\$4.13 box
100/box	27017	\$24.60 box
3" x 3"		
25/box	27018	\$5.82 box
100/box	27029	\$26.10 box
4" x 4"		
25/box	27030	\$7.98 box
100/box	27031	\$30.65 box

G. Kendall Curity® Non-Sterile Gauze Sponges

12-ply		
2" x 2", 200/pkg.	27313	\$6.42 pkg.
3" x 3", 200/pkg.	27314	\$11.85 pkg.
4" x 4", 200/pkg.	27315	\$18.10 pkg.

H. Versalon™ Sterile Sponges

4-ply		
2" x 2", 25/2's	27316	\$3.01 pkg.
3" x 3", 25/2's	27317	\$3.93 pkg.
4" x 4", 25/2's	27318	\$5.82 pkg.

F. Kendall Conform® Stretch Gauze Bandage

1" x 4.1 yds., Stretched	27089	\$1.58 roll
2" x 4.1 yds., Stretched	27090	\$1.87 roll
3" x 4.1 yds., Stretched	27091	\$2.18 roll
4" x 4.1 yds., Stretched	27092	\$2.39 roll

I. Curity™ Sterile Abdominal Pads with Wet Proof Barrier

This pad consists of three layers: soft outer non-woven layer, fluff filler for absorbency, and a Wet-Pruf™ barrier to prevent fluid strike-through. All four edges are sealed to prevent lint residue and leaking.

5" x 9", 36/pkg.	27359	\$19.70 pkg.
--------------------------	--------------	--------------

Cosmopor

An adhesive wound dressing that is soft and gentle on the skin. Indicated for use in protection of post-surgical wounds and wounds with low-to-moderate exudate levels.

- Used for patients with sensitive skin
- Conforms well to body contours and remains in place
- Rounded corners help reduce the need to change the dressing
- Good absorbency and cushioning effect
- Fluid-repellent backing
- Great for large wounds

2.8" x 2", 50/pkg.	1002755	\$16.99 pkg.	4" x 4", 25/pkg.	1002780	\$23.99 pkg.
4" x 3.2", 25/pkg.	1002776	\$21.99 pkg.	10" x 4", 25/pkg.	1002779	\$49.99 pkg.
6" x 3.2", 25/pkg.	1002777	\$27.99 pkg.	6" x 6", 25/pkg.	1002781	\$35.99 pkg.
8" x 4", 25/pkg.	1002778	\$44.99 pkg.			



Not made with Natural Rubber Latex.

Gauze, Sponges, & Bandages



A



C



B



D

A. Dukal Sterile Gauze Pads

2" x 2", 12-ply, 100/box	27377	\$8.48 box
3" x 3", 12-ply, 100/box	27378	\$10.40 box
4" x 4", 12-ply, 100/box	27379	\$14.20 box
2" x 2", 12-ply, 25/box	27380	\$3.22 box
3" x 3", 12-ply, 25/box.	27381	\$4.09 box
4" x 4", 12-ply, 25/box.	27385	\$5.68 box

B. Dukal Non-Sterile Top Sponge

4" x 4", 100/bag	27370	\$9.16 bag
------------------	-------	------------

Dukal Non-Sterile, Non-Woven Sponges

2" x 2", 4-ply, 200/bag	27386	\$3.10 bag
3" x 3", 4-ply, 200/bag	27387	\$6.27 bag
4" x 4", 4-ply, 200/bag	27388	\$7.67 bag

C. Dukal Non-Sterile Gauze Sponges

2" x 2", 8-ply, 200/bag	27371	\$3.52 bag
3" x 3", 8-ply, 200/bag	27373	\$7.02 bag
4" x 4", 8-ply, 200/bag	27375	\$9.65 bag
2" x 2", 12-ply, 200/bag	27372	\$4.99 bag
3" x 3", 12-ply, 200/bag	27374	\$9.21 bag
4" x 4", 12-ply, 200/bag	27376	\$12.95 bag

D. Dukal Non-Sterile New Sponges

2" x 2", 4-ply, 200/bag	27389	\$2.95 bag
3" x 3", 4-ply, 200/bag	27390	\$6.99 bag
4" x 4", 4-ply, 200/bag	27391	\$8.02 bag



A



B



C

A. Dukal Conforming Gauze

Non-Sterile

2", 12/bag	27405	\$6.13 bag
3", 12/bag	27406	\$7.69 bag
4", 12/bag	27407	\$8.86 bag
6", 6/bag	27408	\$9.09 bag

Sterile

2" x 4.1 yds.	27401	\$0.75 roll
3" x 4.1 yds.	27402	\$0.91 roll
4" x 4.1 yds.	27403	\$1.06 roll
6" x 4.1 yds.	27404	\$1.99 roll

B. Kendall Conform® Stretch Gauze Bandage

1" x 75" (4.1 yds., Stretched)	27089	\$1.58 roll
2" x 75" (4.1 yds., Stretched)	27090	\$1.87 roll
3" x 75" (4.1 yds., Stretched)	27091	\$2.18 roll
4" x 75" (4.1 yds., Stretched)	27092	\$2.39 roll

C. Dukal Rolled Gauze

Non-Sterile

2", 12/bag	27361	\$5.04 bag
3", 12/bag	27362	\$8.00 bag
4", 12/bag	27363	\$9.09 bag

Sterile

2" x 5 yds.	27365	\$0.93 roll
3" x 5 yds.	27366	\$1.14 roll
4" x 5 yds.	27367	\$1.28 roll

FREE SHIPPING at SchoolHealth.com/SportsMed

Get FREE SHIPPING on your online order over \$100! Go to the back cover for Free Ship Online code. Can only be used once per customer. Expires 12-31-20.

Gauze & Bandages



Surgilast Tubular Elastic Bandages

Bandages can be custom cut to facilitate dressing of difficult bandage areas. They are more secure than tape, painless on removal, and harmless to fragile skin. Allows maximum air-flow. Wide range of sizes.

25 yds./box		
Size 1 (fingers, toes, & wrist)		
.....	.31085	\$12.99 box
Size 2 (Small: hand, arm, leg, foot)		
.....	.31086	\$14.99 box
Size 3 (Medium: hand, arm, leg, foot)		
.....	.31087	\$16.99 box
Size 4 (Large: hand, arm, leg, foot)		
.....	.31088	\$19.99 box
Size 5 (Small: hand, shoulder, thigh)		
.....	.31089	\$17.99 box



Finger/Toe Bobs

A cloth covering made of two rolled bandage rings. Used for cuts, burns, blisters, corns, and ulcers. Assorted colors.

Medium, 50/box.....	.27173	\$52.60 box
Large, 25/box.....	.27174	\$51.20 box

Not made with Natural Rubber Latex.



Hartmann Flexicon®

Light compression, conforming, stretch bandage holds dressings securely, minimizing lint, and unraveling.

Non-Sterile		
1" x 4.1 yds.		
24/pkg.....	.27024	\$10.75 pkg.
2" x 4.1 yds.		
12/pkg.....	.27034	\$6.59 pkg.
3" x 4.1 yds.		
12/pkg.....	.27035	\$9.12 pkg.
4" x 4.1 yds.		
12/pkg.....	.27039	\$10.95 pkg.
Sterile		
1 Roll/pkg.		
1" x 4.1 yds.....	.27003	\$0.90 roll
2" x 4.1 yds.....	.27004	\$1.05 roll
3" x 4.1 yds.....	.27005	\$1.22 roll
4" x 4.1 yds.....	.27006	\$1.46 roll



Hartmann Conforming Stretch Bandage

Secure bandage that offers absorbency in a conforming gauze material.

Non-Sterile		
24/pkg.		
1" x 4.1 yds.....	.27501	\$9.26 pkg.
12/pkg.		
2" x 4.1 yds.....	.27082	\$6.73 pkg.
3" x 4.1 yds.....	.27083	\$7.47 pkg.
4" x 4.1 yds.....	.27084	\$10.80 pkg.
6/pkg.		
6" x 4.1 yds.....	.27081	\$9.66 pkg.
Sterile		
1 Roll/pkg.		
2" x 4.1 yds.....	.27086	\$1.26 roll
3" x 4.1 yds.....	.27087	\$1.41 roll
4" x 4.1 yds.....	.27088	\$1.58 roll
6" x 4.1 yds.....	.27085	\$2.32 roll



Hartmann Omnifix®

A non-woven polyester material coated with an acrylic. Not made with natural rubber latex adhesive. The release paper backing has wavy slits to improve speed and use of application.

- Compares to Cover-Roll
 - Soft non-woven fabric with non-sensitizing acrylic adhesive coating provides complete cover security for wound dressings
 - Ideal for athletes with sensitive skin and/or tendency toward skin allergies
 - Non-sterile, permeable to air and water vapor
- | | | |
|-------------------|----------------|--------------|
| 2" x 10 yds. | .28255 | \$12.75 roll |
| 4" x 10 yds. | .28256 | \$18.85 roll |
| 6" x 10 yds. | 1006484 | \$21.99 roll |

Cotton Balls, Rolls, & Applicators



School Health Brand Cotton-Tipped Applicators
Cotton-wound on one end. Non-sterile.

Length	Quantity	Product Code	Price
3" Length	100/pkg	99303	\$0.78 pkg.
3" Length	1,000/box	90851	\$6.91 box
6" Length	100/pkg	99306	\$0.96 pkg.
6" Length	1,000/box	90852	\$7.93 box



A



B



C



D



E



F

A. Absorbent Cotton Balls, Non-Sterile

Medium Size

2,000/bag30020	\$13.35 bag
4,000/case30022	\$25.70 cs.

500/bag

.....30011	\$5.16 bag	Case of 8 \$4.98 bag
------------	------------	----------------------

Large Size

1,000/bag30021	\$17.80 bag
2,000/case30023	\$32.55 cs.

200/bag

.....30015	\$4.53 bag	Case of 10 \$4.37 bag
------------	------------	-----------------------

Jumbo Size

100/bag30026	\$1.78 bag
---------	------------	------------

B. Absorbent Cotton Balls, Sterile

Large Size

130/box30004	\$5.17 box
500/box30005	\$11.65 box

C. Cotton Swabs

Double-tipped. Flexible.

3" Length	
300/box90048 \$4.42 box

D. Combine Roll

For analgesic packs and wet dressings.

8" x 20 yds.30008	\$43.90 ea.
--------------	------------	-------------

Cotton Rolls

Made of 100% absorbent cotton. Keeps its shape when wet. Can be used for nasal packing.

Non-Sterile, 1½" x ¾",	
2,000/box30027 \$45.80 box

E. Generic Cotton Rolls

2,000/box30025	\$20.05 box
-----------	------------	-------------

F. Cotton Roll Dispenser

Top flips back for easy loading. Sliding drawer dispenses up to four rolls with a single pull. Clear acrylic. Holds approximately 50 rolls.

4" x 3½" x 2"90099	\$33.95 ea.
---------------	------------	-------------

Bleeding Control



Standard Trauma Kit

- Standard trauma bag with easy to carry shoulder strap and handle
 - Several different products to handle trauma situations
 - Perfect kit for first responders
- Complete Kit **90894** \$157.50 kit

See kit content on the our website!



Blood Clotting Spray

Medique blood clotting spray contains benzethonium chloride (0.2%) as a topical antiseptic and lidocaine (4%) as a pain numbing anesthetic. Ideal for minor cuts, scrapes, and burns.

. **50227** \$10.99 ea.

STOPS BLEEDING IN SECONDS!



Stiptik® Swabpoules

Stops bleeding of minor cuts and abrasions within 10–20 seconds. Easy storage and application. Break the glass ampoule and the solution saturates the applicator tip. Each Swabpoule is 0.7 mL.

10/pkg. **49041** \$25.29 pkg.
25/pkg. **49086** \$55.85 pkg.



Mueller® Fiber-Free Nasal Sponges

Sponges hydrate and expand to absorb blood and apply pressure to stop bleeding. Fiber-free sponge material. Individually wrapped.

Sterile, 25/pkg. **30014** \$171.50 pkg.



Mueller® Nasal Plugs

Non Sterile, 1½" long, 300/pkg. **30013** \$19.70 pkg.



NosebleedQR™ Kit with Swabs

Stops nosebleeds instantly. Forms an artificial scab that seals and protects against infection. Remove scab for suturing. Non-toxic and hypoallergenic. Includes applicator for hard-to-treat areas.

2/pkg. **44474** \$11.25 pkg.



Celox® Nosebleed Dressing

A small, specially-shaped pad bonded with full-strength Celox granules. The pad may be easily inserted into the nostril to stop bleeding fast.

5/box. **49234** \$24.99 box



Curad® Bloodstop

- Helps stop bleeding quickly
- Works best for cuts, abrasions, or nosebleeds
- Gauze turns into gel to seal the wound
- Biocompatible, 100% natural fiber cellulose
- Non-irritating
- Acts in less than 1 minute
- Sterile hemostat gauze pad

1" x 1", 10/box. **49267** \$11.50 box



BleedCEASE® & NasalCEASE®

First aid for cuts and nosebleeds.

Features:

- Releases calcium which accelerates clotting
- Painless, non-irritating
- Highly absorbent
- Non-stick removal—no disturbing new clots
- For use by all ages
- 100% natural formulation
- No side effects—no contraindications
- Quickly return to what you were doing

NasalCEASE
5/pkg. **23047** \$15.45 pkg.
BleedCEASE
25/box **23045** \$26.70 box
100/box **23046** \$89.75 box

Not made with Natural Rubber Latex.

School Health Brand Premium Exam Gloves

- New, advanced stretch-synthetic material
- Not made with natural rubber latex or DEHP
- Soft and supple for excellent dexterity
- Tapered cuff for outstanding fit
- Clean white color



SH School Health Brand Premium Powder-Free Exam Gloves

Made from a proprietary formula, School Health premium white gloves provide the highest tactile sensitivity, the best fit and a greater barrier protection.

100/box		1-9 Boxes	Case of 10
Small	21324	\$9.40 box	\$8.29 box
Medium	21325	\$9.40 box	\$8.29 box
Large	21327	\$9.40 box	\$8.29 box
X-Large	21328	\$9.40 box	\$8.29 box



SH School Health Brand Vinyl Powder-Free Gloves

Our clear, powder-free exam gloves are a cost-effective alternative that are ideal for general patient care.

100/box		1-9 Boxes	Case of 10
Small	21311	\$7.98 box	\$6.99 box
Medium	21312	\$7.98 box	\$6.99 box
Large	21313	\$7.98 box	\$6.99 box
X-Large	21314	\$7.98 box	\$6.99 box



Medline® Generation Pink Vinyl Exam Gloves

Powder-free patented vinyl exam gloves have the comfort, barrier protection, and price you love. When you choose Generation Pink gloves, you're helping support the National Breast Cancer Foundation.

100/box		1-9 Boxes	Case of 10
Small	21544	\$10.15 box	\$8.93 box
Medium	21545	\$10.15 box	\$8.93 box
Large	21546	\$10.15 box	\$8.93 box



Black Nitrile Exam Gloves

Powder-free, ambidextrous, nonsterile in a dispenser box.

100/box		
Medium	21467	\$16.05 box
Large	21468	\$16.05 box
X-Large	21469	\$16.05 box

MORE ONLINE

For our full selection of gloves, plus more colors, go to: SchoolHealth.com/gloves

Not made with Natural Rubber Latex.

Nitrile Exam Gloves



School Health Brand Nitrile Exam Gloves

- Comfortable fit
- Excellent sensitivity
- Dependable protection
- Reliable grip
- Crisp blue color
- Not made with natural rubber latex or DEHP



GIVE THEM A TRY!
RECEIVE A FREE
SCHOOL HEALTH NITRILE
GLOVE SAMPLE PACK WITH
YOUR NEXT ORDER!*

SchoolHealth.com/free-glove-sample

*Limit one sample pack of each size per order.

SH Nitrile Powder-Free Gloves

School Health's Nitrile gloves have a strong and flexible design that makes them ideal for all-around use. These ice blue color gloves provide a comfortable fit and dependable protection. The textured fingertips create a reliable grip and allow for increased dexterity.

		1-9 Boxes	Case of 10
200/box			
Small	21547	\$19.40 box	\$16.99 box
Medium	21548	\$19.40 box	\$16.99 box
Large	21550	\$19.40 box	\$16.99 box
180/box			
X-Large	21551	\$19.40 box	\$16.99 box



A



B



C



D

A. SafeSkin™ Purple Nitrile Gloves

Powder-free gloves with textured fingertips.

		1-9 Boxes	Case of 10
100/box			
Small	21258	\$17.95 box	\$15.80 box
Medium	21259	\$17.95 box	\$15.80 box
Large	21260	\$17.95 box	\$15.80 box
90/box			
X-Large	21261	\$17.95 box	\$15.80 box

B. SafeSkin™ Lavender Nitrile Gloves

Thinner and lighter than other nitrile gloves. Powder-free.

		1-9 Boxes	Case of 10
250/box			
Small	21526	\$29.70 box	\$25.99 box
Medium	21527	\$29.70 box	\$25.99 box
Large	21528	\$29.70 box	\$25.99 box
230/box			
X-Large	21529	\$29.70 box	\$25.99 box

C. Sterling Nitrile® Gloves

Powder-free.

		1-9 Boxes	Case of 10
200/box			
Small	21582	\$27.60 box	\$24.29 box
Medium	21583	\$27.60 box	\$24.29 box
Large	21584	\$27.60 box	\$24.29 box
170/box			
X-Large	21585	\$27.60 box	\$24.29 box

D. Nitriderm® COATS™ Powder-Free Nitrile Exam Gloves

Our new COATS barrier technology utilizes all natural, beta-glucan rich, colloidal oatmeal USP. The colloidal oatmeal barrier shields the skin surface from the glove and also creates a moisturizing, pH balancing environment that helps dry, damaged skin to repair itself so healthy skin can stay healthy!

200/box			
Small	1003685	\$23.90 box	
Medium	1003686	\$23.90 box	
Large	1003687	\$23.90 box	
X-Large	1003688	\$23.90 box	

Not made with Natural Rubber Latex.



Powder-Free Latex Exam Gloves

100/box		1-9 Boxes	Case of 10
Small	21075	\$12.65 box	\$10.99 box
Medium	21076	\$12.65 box	\$10.99 box
Large	21152	\$12.65 box	\$10.99 box
X-Large	1003689	\$13.00 box	\$11.44 box



NEW!



Restore Touch Nitrile Exam Gloves with Oatmeal

Restore gloves with maxOat+ colloidal oatmeal can help hydrate and soothe the skin. This innovative glove is meant to provide extra care for hardworking hands and adds a new level of protection for your staff. The National Eczema Association has awarded the Seal of Acceptance to Restore gloves. Meets the standard ASTM D6978-05 for providing protection against select chemotherapy drugs.

Green color, 300/box

X-Small	1033921	\$19.99 box
Small	1033922	\$19.99 box
Medium	1033923	\$19.99 box
Large	1033924	\$19.99 box
X-Large	1033925	\$19.99 box



Diamond Grip Latex Gloves

Textured, tough, and reliable.

100/box		1-9 Boxes	Case of 10
Small	21283	\$22.85 box	\$20.49 box
Medium	21284	\$22.85 box	\$20.49 box
Large	21285	\$22.85 box	\$20.49 box
X-Large	21286	\$22.85 box	\$20.49 box



A



B



C



D



E

Wire Glove Box Holders

Made of steel with a baked-on white finish, includes wall mounting hardware.

A. Single or Double Glove Holder

11"W x 5½"H x 4"D.....90113 \$15.80 ea.

B. Double Glove Holder

11"W x 10½"H x 4"D.....91240 \$32.30 ea.

C. Triple Glove Holder

11½"W x 17"H x 4½"D.....91087 \$34.55 ea.

D. B-D Guardian Glove Box Cabinet

Glove box cabinet includes a hinged cover and tension bar and is made from high-impact polystyrene. Accommodates most box sizes.

11¾"W x 4½"H x 6"D.....90079 \$33.35 ea.

E. Hygiene Station 3-Compartment

Help prevent the spread of germs in your workplace. Holds two boxes of tissues, one germicidal canister, and one hand sanitizer pump (supplies not included). Wall mountable (mounting hardware not included).

.....90623 \$147.50 ea.

MORE ONLINE

For our full selection of gloves, plus more colors, go to: SchoolHealth.com/gloves

Not made with Natural Rubber Latex.

Surface Disinfectants & Cleaners



CaviCide® and CaviWipes®

A family of multi-purpose disinfectants/decontaminants that can be used on hard, non-porous surfaces. When used as directed, fragrance-free CaviCide and CaviWipe products will effectively clean and disinfect surfaces and can help reduce the risk of cross contamination.

CaviCide1® 1 MINUTE KILL TIME!

CaviCide1, can effectively kill 99.9% of bacteria, viruses, and fungi in 1-minute, including TB, Norovirus, A. baumannii, HIV-1, HBV, HCV, and many more.

Trigger Spray, 24 oz.50222	\$15.70 ea.
Gallon Refill34822	\$38.25 ea.
Wipes		
9" x 12", 65/can49262	\$16.75 ea.
6" x 6", 160/can49269	\$14.75 ea.

CaviCide® 2-3 MINUTE KILL TIME!

Kills MRSA in 3 minutes, and HIV-1, HCV, and HBV in 2 minutes. Ideal for cleaning and decontamination of environmental and medical device surfaces.

Pump Spray, 8 oz.....	.50012	\$6.84 ea.
Trigger Spray, 24 oz.50046	\$13.40 ea.
Gallon Refill34189	\$34.35 ea.
Towelettes, 160/pkg.....	.49075	\$12.90 ea.
Wipes, 6" x 6.75", 220/can.....	1003092	\$14.75 ea.



Matguard Antiseptic Body Wipes

Matguard Antiseptic Wipes are extra-large, full body moisturizing body wipes that can be used for a complete body wipe down after athletic activity. Perfect for on-the-go athletes who may not have time to shower!

10" x 12", 65/can	1008219	\$33.50 ea.
-------------------------	---------	-------------

MatPRO® Concentrated Mat & Surface Disinfectant

MatPRO concentrated surface disinfectant is a highly effective formula to protect against a broad spectrum of germs and viruses. Disinfects, deodorizes, and sanitizes all hard surfaces, including mats, floors, equipment, etc.

1 gallon.....	1008222	\$55.95 ea.
---------------	---------	-------------

Matguard Equipment & Surface Wipes

Matguard® equipment and surface wipes are extra-large, very durable wipes that kill bacteria without degrading equipment.

10" x 11", 65/can	1008221	\$28.95 ea.
-------------------------	---------	-------------

Matguard Body Cleanse Spray

Matguard® Body Cleanse Spray is an all-over body spray that leaves you clean after athletic activity, while softening skin without leaving a sticky residue. This antiseptic spray kills 99.9% of the germs and bacteria and is ideal for on-the-go athletes who may not have time to shower.

8 oz. Unscented	1008220	\$19.60 ea.
-----------------------	---------	-------------



Pure Hard Surface Disinfectant

Disinfectant, fungicide, virucide. EPA approved category IV. GRAS status as contact biocide. Safe for use around food. 24-Hour residual protection. Eliminates more than 30 harmful germs in 2 minutes or less. Safe to use around children. No rinse required, Non-corrosive, odorless, non-staining, and no skin irritation.

32 oz.....	.50213	\$21.10 ea.
1 gallon.....	.34700	\$48.35 ea.

Surface Disinfectants & Cleaners



D. Sani-Cloth® AF3 Germicidal Wipes

Protecting your patients has never been easier. Sani-Cloth AF3 is an alcohol and fragrance-free, quaternary-based surface disinfection wipe that is ideal for use around patients and staff, especially those with respiratory sensitivities.

- Fragrance-free formulation; no harsh odors
- Perfect for hard, non-porous surfaces sensitive to alcohol
- Fragrance, alcohol, bleach, acid, phenol, acetone and ammonia free
- Meets CDC, OSHA and CMS Tag F441 guidelines
- Bactericidal, Tuberculocidal, Virucidal

Effective against 44 microorganisms in 3 minutes, including:

- Klebsiella pneumoniae - NDM-1
- Klebsiella pneumoniae - Carbapenem Resistant
- CA-MRSA USA 300 and 400
- RSV
- HBV
- HCV
- HIV

Large, 6" x 6¾", 160/can.....	49256	\$10.30 ea.
X-Large, 7½" x 15", 65/can.....	49257	\$14.65 ea.
Individually Wrapped, 5" x 8", 50/box.....	49258	\$14.20 box
Individually Wrapped, 11½" x 11¾", 50/box....	49259	\$44.45 box

A. Sani-Cloth® HB

Hard surface disinfectant wipe that is effective against the hepatitis B virus and more than 100 other microorganisms. Alcohol-free.

Large, 6" x 6¾", 160/can.....	49050	\$10.10 ea.
X-Large, 8" x 14", 65/can.....	49085	\$15.10 ea.

B. Super Sani-Cloth® Germicidal Disposable Cloths

Effective against gram-positive and gram-negative bacteria and viruses on hard surfaces. Kills TB in one minute; 55% alcohol base.

Large, 6" x 6¾", 160/can.....	49010	\$10.10 ea.
X-Large, 8" x 14", 65/can.....	49084	\$14.85 ea.
Individually Wrapped, 11" x 12", 50/box.....	49023	\$44.80 box

C. Sani-Cloth® Plus Hard Surface Disinfectant

Bactericidal, tuberculocidal and virucidal. Kills HIV-1 (AIDS virus), influenza, and herpes simplex type II in five minutes or less. Low-alcohol base 14.85%.

Large, 6" x 6¾", 160/can.....	49055	\$10.10 ea.
-------------------------------	--------------	-------------

E. Sani-Cloth® Bleach Germicidal Disposable Wipe

EPA registered, ready to use, pre-moistened disinfecting wipe. Impregnated with a stabilized bleach solution that is equivalent to a 1:10 bleach dilution.

Ideal for use in healthcare settings to disinfect hard, non-porous surfaces. Effective against 38 microorganisms in four minutes, including the following: Pseudomonas aeruginosa, Escherichia coli, Streptococcus pyogenes, Methicillin Resistant Staphylococcus aureus (MRSA), Influenza A virus/Hong Kong, Human Coronavirus Strain 229E and various others.

Sani-Cloth Bleach is a bactericidal, fungicidal, tuberculocidal and virucidal in four minutes. Compliant with the Centers for Disease Control and Prevention (CDC) Guideline for Disinfection and Sterilization in healthcare facilities recommendation for the use of a 1:10 sodium hypochlorite in high endemic or outbreak situations. Also meets the Bloodborne Pathogens Standard from the Occupational Safety and Health Administration (OSHA).

Large, 6" x 10½", 75/can.....	49249	\$14.80 ea.
-------------------------------	--------------	-------------

F. Adjustable Bracket

Hold your Sani-Cloth canister in place with an easy-to-mount wall bracket. Can also mount to a pole.

Fits 65/can or 160/can.....	91083	\$37.05 ea.
-----------------------------	--------------	-------------



2XL Care Wipes

2XL Care Wipes Antibacterial Force towelettes are perfect for controlling and eliminating organisms on high-traffic surfaces that people come into contact with everyday. An easy and hygienic way to lower the risk of infection and cross contamination.

Features:

- 60 second kill time
- Clean-As-You-Go bucket maintains a healthy and sanitary environment
- Soft, durable non-irritating, non-toxic and non-abrasive
- Environmentally friendly towelette and solution
- Extra-thick, super-absorbent, 8" x 6" size, perfect to sanitize surfaces and kill 99.9% of bacteria, including Salmonella and E. coli
- Alcohol-free, phenol-Free, bleach-Free

A. Antiseptical Force Wipes 800/pkg.....	49282	\$49.10 pkg.
B. Antiseptical Force Refills 800/pkg.....	49283	\$47.10 pkg.

Wall Mount Dispenser Options	
C. Wall Mount Dispenser for 2XL-Wipes	91622 \$47.15 ea.
D. Stainless Steel Dispenser for 2XL-Wipes	49289 \$460.00 ea.

Not made with Natural Rubber Latex.

Surface Disinfectants & Cleaners



Lysol® Brand I.C.™ Quaternary Disinfectant Cleaner (Concentrate)

Virucidal, fungicidal, and bactericidal, this multi-purpose, hospital disinfectant cleans and disinfects hard, nonporous surfaces. The economical, concentrated formula makes up to 256 gallons (1:256). This neutral pH germicidal detergent is ideal for use on floors and can be used on walls, glazed porcelain, plastic surfaces (such as polypropylene, polystyrene, etc.), and other hard, nonporous surfaces. EPA registered.

Gallon34222 \$44.40 ea.



Professional Lysol® Brand No Rinse Sanitizer (Concentrate)

Meets food code requirements as a no-rinse sanitizer and is perfect for a 3-bin sink and clean-in-place applications. It is an economical, concentrated formula that makes up to 512 gallons (1:512) and can be used as a disinfectant. Use on floors, walls, furniture, bathtubs, shower stalls, toilet seats, food service, and processing areas. NSF Category Code D2. EPA registered.

Gallon34586 \$26.10 ea.



Professional Lysol® Brand Antibacterial All Purpose Cleaner (Concentrate)

Kills Salmonella, Escherichia coli (E. coli), Staph, and other bacteria. It also controls mold and mildew and counteracts odors. Makes up to 128 gallons (1:128) when used for light duty cleaning and sanitizing, up to 64 gallons (1:64) when used for heavy duty cleaning and sanitizing. Use on floors, walls, counters, equipment, food service, and dietary areas. NSF Category Code D1. EPA registered.

Gallon34603 \$28.55 ea.



A

B

A. Lysol® Brand II Disinfecting Wipes

Each thick, pre-moistened wipe kills 99.9% of viruses and bacteria on hard, nonporous surfaces when used as directed. Packaged in several convenient sizes, this product is ideal for cleaning, disinfecting and deodorizing. Use on kitchen counters, appliances, stove tops, cabinets, floors, garbage cans, toilet exteriors, bathtubs and sinks. EPA registered.*

Lemon & Lime Blossom		Ocean Fresh	
35/can49068	\$6.58 ea.	80/can49220	\$10.80 ea.
80/can49203	\$10.80 ea.		
110/can49219	\$13.45 ea.		



C

B. Lysol® Brand III Dual Action™ Disinfecting Wipes

Each pre-moistened wipe kills 99.9% of viruses and bacteria on hard, nonporous surfaces when used as directed. Packaged in several convenient sizes, this product is ideal for cleaning, disinfecting, and deodorizing. Use on kitchen counters, appliances, stove tops, cabinets, floors, garbage cans, toilet exteriors, bathtubs, and sinks. Dual Action has two sides. One for scrubbing and one for wiping. Built-in scrubbing fibers help clean away tough stains like soap scum. EPA registered.*

Citrus Scent			
35/can49217	\$6.73 ea.	75/can49218	\$10.55 ea.



D

E

C. Professional Lysol® Brand III Disinfectant Spray Original

This tuberculocidal, virucidal, fungicidal and bactericidal formula kills 99.9% of germs on hard, nonporous surfaces, and is effective against over 50 microorganisms, including H1N1 (influenza A virus), MRSA, Norovirus, Rhinovirus, Poliovirus Type 1, Hepatitis A virus, Hepatitis B virus, and HIV-1 (AIDS virus) when used as directed. This product eliminates odors and prevents the growth of mold and mildew. Use on showers, sinks, countertops, around toilet areas, toys, telephones, garbage bins, waiting rooms, and in laboratories. NSF Category Code D1. EPA registered. EPA # 777-99-675.*

19 oz.			
Original50025	\$11.00 ea.	Fresh Scent50159	\$11.00 ea.

D. Lysol® Brand III I.C.™ Disinfectant Spray

Tuberculocidal, virucidal, fungicidal, and bactericidal and kills 99.9% of germs on hard, nonporous surfaces, including MRSA, Norovirus, Hepatitis A virus, Hepatitis B virus, HIV-1 (AIDS virus) Pandemic 2009 H1N1 Influenza A virus. It is effective against over 50 microorganisms when used as directed. The CONTROL FLO™ VALVE produces a wetter spray, enhancing surface coverage. This product meets CDC, EPA and OSHA Bloodborne Pathogen Standards. Use on showers, sinks, door handles, waiting rooms, sick rooms, laboratories, and around toilet areas. EPA registered. EPA # is 777-99-67.*

19 oz.	50047	\$13.25 ea.
-------------	-------	-------------

E. Lysol® Brand I.C.™ Foaming Disinfectant Cleaner

This ready-to-use quaternary formula contains no harsh acids, abrasives, or bleach, and can be used to clean, disinfect, and deodorize. This product meets AOAC efficacy standards for hospital aerosol disinfectants. Use on fiberglass fixtures, glazed porcelain, synthetic marble, glazed tile, hard plastic, and vinyl. NSF Category Code C2. EPA registered.*

24 oz.	34233	\$6.10 ea.
-------------	-------	------------

*When used as directed.

Surface Disinfectants & Cleaners



A



B



C



D

Ideal for wrestling mats!



E



F

A. Clorox® Anywhere® Hard Surface™

Revolutionary bleach-based formula allows for daily sanitization. Kills 99.9% of bacteria on hard, non-porous surfaces within two minutes. Gentle enough to use on surfaces around children and on food-prep surfaces. No rinsing required after application.

32 oz. **50157** \$9.37 ea.

B. Clorox® Disinfectant Wipes

Pre-moistened wipe that kills 99.9% of germs, including viruses that cause colds and flu (Rhinovirus and Influenza A2). Better cleaning in a thicker, textured wipe. Also effective against common bacteria such as Staphylococcus (Staph.), Salmonella, and E.coli. 75-count canister.

Lemon Scent **49187** \$10.25 ea.

Fresh Scent **49188** \$10.25 ea.

C. Clorox® Germicidal

Ready-to-use, hospital-grade disinfectant. Kill claims for over 30 different microorganisms, including MRSA, HIV Type 1, Pseudomonas aeruginosa, Staphylococcus aureus, Streptococcus pyogenes, Streptococcus pneumoniae, and Acinetobacter baumannii. Contact time of 30 seconds for most bacteria; and contains the power of Clorox Bleach.

Wipes, 70/can. **49189** \$18.15 ea.

D. Clorox® Pro Quaternary

A quaternary ammonium (bleach-free) formula that cleans and disinfects in one labor-saving step—no rinsing required. Kill claims for over 35 microorganisms, including CA-MRSA, MRSA, Hepatitis B, Avian Influenza A, HIV-1 and HIV-2, SARS-associated Coronavirus, Rotavirus, E. coli, and Salmonella enterica. Bleach free.

Gallon **34542** \$62.35 ea.

E. Clorox® Bleach-Free Disinfecting Wipes

Tough on germs... kills 99.9% of common illness-causing germs, including Staphylococcus aureus (Staph), Salmonella enterica, Escherichia coli (E. coli), and the viruses that can cause colds and flu.

Wipes with Bucket Dispenser

700 ct. **56711** \$68.50 pkg.

Refill Only

700 ct. **49212** \$59.05 pkg.

F. Clorox® Disinfectant Spray

Sanitizes, disinfects, and deodorizes. Effective quaternary based and ethanol-based disinfectant agent effective against E. coli, TB, H1N1, Hepatitis A virus, and MRSA.

19 oz. **50153** \$7.30 ea.



Clorox® Hospital Cleaner Disinfectant with Bleach

Meets OSHA, CDC, and NCCLS standards for decontamination.

Cleans, brightens, and disinfects most surfaces without scratching. More effective than diluted bleach because of added cleaning ingredients. One-minute effectiveness on HIV-1 (AIDS virus), Staph, Salmonella, Pseudomonas, herpes simplex virus (HSV-2), and polio virus. Two-minute effectiveness on Mycobacterium tuberculosis (TB). 0.55% NaOCl (5500 ppm). EPA # 56392-7. Not recommended for use on vinyl.

Spray

22 oz. **50065** \$21.25 ea.

32 oz. **50066** \$23.40 ea.

64 oz. Refill **34196** \$26.85 ea.

Clorox® Cleaning Towels with Bleach

High-quality disposable cleaning towels saturated with 0.55% sodium hypochlorite and detergent. 0.55% NaOCl (5500 ppm).

9" x 10", 60/pkg. **49029** \$21.15 pkg.

7" x 8", 150/pkg. **49148** \$24.05 pkg.



Clorox® Hydrogen Peroxide Cleaner Disinfectant

- Kills most viruses and bacteria in 30 seconds to 1 minute
- Kills TB in 5 minutes, Norovirus in 3 minutes and Fungi in 8 minutes
- No harsh chemical fumes or smell
- Less irritating for skin
- No fragrances or dyes added
- Non-combustible, non-staining

32 oz. Spray. **50219** \$11.90 ea.

128 oz. Refill **34703** \$25.10 ea.

Wipes, 110/can. **49252** \$19.70 ea.

Wipes, 800/can **49254** \$72.80 ea.



Clorox® Broad Spectrum Quaternary Disinfectant Cleaner

- Only quat registered to kill representatives of all ESKAPE pathogens, which cause two-thirds of all HAIs
- Kills MRSA, HIV, TB, VRE, Hepatitis B and C, and more
- 90 kill claims
- Kills bacteria in 2 minutes
- Fragrance free
- Cuts through grease with powerful cleaning agents
- Gentle on surfaces

32 oz. Spray. **34695** \$13.30 ea.

Gallon **34696** \$31.15 ea.

Surface Disinfectants, Cleaners, & Deodorizers

**NO
RINSE! 30
SECOND
KILL TIME!**



PURELL™ Healthcare Surface Disinfectant

PURELL Healthcare Surface Disinfectant's patented and powerful formulation is fragrance free and contains no harsh chemicals or bleach. The revolutionary formulation was designed to accelerate the germ-killing power of alcohol, without the use of harsh chemicals. This broad-spectrum, one-step surface disinfectant, and cleaner rapidly eliminates 27 organisms, including 30-second disinfection of MRSA, VRE and Norovirus.

32 fl. oz. Spray	1006774	\$12.50 ea.
Gallon Refill	1006776	\$26.90 ea.

PURELL™ Professional Surface Disinfectant

PURELL Professional Surface Disinfectant is a one-step cleaner and sanitizer that dissipates quickly and cleanly with no streaks or sticky residue. The no-rinse, multi-surface, fragrance-free spray eliminates germs on surfaces, including Norovirus, E. Coli, and Salmonella in 30 seconds. The lowest allowable EPA toxicity rating makes this safe even on food contact surfaces.

32 fl. oz. Spray	1006775	\$12.90 ea.
Gallon Refill	1006777	\$30.55 ea.



A. Micro-Kill+ Disinfectant Wipes

Medline Micro-Kill+™ Wipes are EPA-registered as a disinfectant bactericidal, virucidal, fungicidal, and tuberculocide. Effective against difficult to kill microorganisms, including MRSA, VRE, and Tuberculosis within 2 minutes. Effective against bloodborne pathogens Hepatitis B, Hepatitis C, and HIV-1. Heavy-duty fabric stands up to hard-surface scrubbing and contains enough liquid to ensure maximum surface coverage. Can be used to clean and disinfect most hard, non-porous surfaces. No pre-mixing or dilution needed.

6" x 6.75", 160/pkg	1000138	\$10.35 pkg.
---------------------------	----------------	--------------

B. Micro-Kill Alcohol-Free Disinfectant Wipes

Micro-Kill™ is an effective bleach-free and alcohol-free disinfectant cleaner with a fresh, clean scent. Even without bleach or alcohol, Micro-Kill can achieve disinfection of Tuberculosis and other difficult-to-kill organisms. Wipes are intended for use on most hard, non-porous surfaces. Alcohol-free formula is safe to use on most thin plastics, electrical cords, and other surfaces typically harmed by alcohol-based products. Non-fuming, light, pleasant fragrance is ideal to use around patients that are on oxygen or sensitive to harsh odors.

6" x 6.75", 160/pkg	1000139	\$10.80 ea.
---------------------------	----------------	-------------

C. Sani-Q

Sani-Q is a ready to use food service surface cleaning wipe. This product does not require a potable water rinse after application. Can be used on food processing equipment and food contact surfaces without rinsing. 6" x 7".

160/can	1002079	\$9.86 ea.
---------------	----------------	------------

D. SaniZide Plus® Germicidal Wipes

Pre-saturated hard surface wipes kill TB, VRE, E. Coli, and more in 10 minutes and HIV-1 in 2 minutes. It leaves behind virtually no lint or particles to scratch or contaminate surfaces. It is a dual quaternary, alcohol-free formula, non-flammable, safe to ship, and non-corrosive on surfaces.

160/can49192	\$12.00 ea.
---------------	---------------	-------------

E. Claire Disinfectant Spray

Disinfects HIV-1 (AIDS virus), poliovirus types 1 and 2, influenza A2/ Hong Kong virus and herpes simplex virus types 1 and 2 on inanimate environmental surfaces.

15.5 oz.50048	\$9.09 ea.
---------------	---------------	------------

F. Benzalkonium Chloride

8 oz. Solution34680	\$5.48 ea.
Gallon Solution34681	\$21.45 ea.
PDI Towelettes, 100/box49261	\$5.02 box
Economy Towelettes, 100/box49174	\$3.15 box

Hand Sanitizers & Hand Soaps



PURELL® HAND SANITIZER AND WALL DISPENSERS

PURELL® Hand Sanitizers

Gentle on skin, yet kills 99.99% of most common germs that may cause illness. Outperforms other hand sanitizers ounce-for-ounce. Proven to reduce absenteeism when used as part of a complete hand hygiene program.

PURELL® ES8 Hand Sanitizer Dispenser

Touch-free dispenser for PURELL® Brand Hand Sanitizers.

- Energy-on-the-Refill Technology—each refill comes with its own battery integrated into the refill
- AT-A-GLANCE™ Refill Design—monitor product level with just one look
- LOCK OR NOT™ Technology—can convert to a locking system

PURELL® ES4 Hand Sanitizer Dispenser

Push-Style Dispenser for PURELL® Hand Sanitizer.

- AT-A-GLANCE™ Refill Design—monitor product level with just one look
- LOCK OR NOT™ technology—can convert to a locking system

PURELL® LTX Touch-Free Dispenser

PURELL® LTX Touch-Free Dispensers convert to a locking cabinet with key included inside each dispenser.

A. Hand Sanitizer Dispenser, White, ES4 1008601 \$27.10 ea.	D. Advanced Hand Sanitizer Foam Refill for ES8 (1008604) 1008605 \$60.15 ea. 2/case..... 1008606 \$115.50 cs.	F. Touch-Free Dispenser 1,200 mL, Black LTX 1008533 \$115.50 ea.
B. Advanced Hand Sanitizer Foam Refill for ES4 Dispenser (1008601) 1008602 \$38.35 ea. 2/case..... 1008603 \$74.05 cs.	E. Touch-Free Dispenser 1,200 mL, White, LTX 1008532 \$115.50 ea.	G. Hand Sanitizer Foam 1,200 mL refill for LTX (1008532 and 1008533) 1008585 \$38.45 ea. 2/case..... 1008586 \$73.95 cs.
C. Hand Sanitizer Dispenser, White, ES8 1008604 \$130.00 ea.		



PURELL® BRAND SOAP AND DISPENSERS

PURELL® Brand HEALTHY SOAP

New CLEAN RELEASE™ Technology boosts soap performance with its novel surfactant system that reaches deeper into skin's cracks and crevices to gently remove more dirt and germs than regular soap. Formulated for dry and sensitive skin, the new soaps are also free of the most common causes of severe skin irritation. CLEAN RELEASE™ Technology soaps are free of harsh preservatives, antibacterial ingredients, parabens and phthalates.

Kid-friendly: Refreshing, hypoallergenic foam soap formulations with an option for low-dose dispensing for smaller hands.

PURELL® ES4 Soap Dispenser

Reliable, cost-effective push-style dispenser for PURELL® Brand HEALTHY SOAP®.

- AT-A-GLANCE™ Refill Design—monitor product level with just one look
- LOCK OR NOT™ technology—can convert to a locking system

PURELL® ES8 Soap Dispensing System

Touch-free dispenser for PURELL® Brand HEALTHY SOAP®. Addresses the two most common service issues—empty dispensers and worn out batteries.

1. AT-A-GLANCE™ Refill Design—monitor product level with just one look
2. Energy-on-the-Refill Technology—each refill comes with its own battery integrated into the refill
3. Easy Recycling and Disposal—PET easy to disassemble, including removal of the battery; expiry date, right on the front of the bottle

A. Healthy Soap High Performance Foam, Refill for ES4 Dispenser (1008598) 1008599 \$24.95 ea. 2/Case..... 1008600 \$49.70 cs.	B. Healthy Soap High Performance Foam, Refill for ES8 Dispenser (1008590) 1008591 \$42.70 ea. 2/Case..... 1008597 \$85.35 cs.	C. ES4 Push-Style Soap Dispenser, White 1008598 \$27.20 ea. D. ES8 Hand Hygiene Soap Dispenser, White 1008590 \$135.00 ea.
----------------------------------------------------------------------------------------------------------------------------------------------------------------	----------------------------------------------------------------------------------------------------------------------------------------------------------------	-----------------------------------------------------------------------------------------------------------------------------------------------------------------------

* In order to take advantage of the "Free Dispenser with Purchase" promotion, email Salesops@gojo.com and provide the SKU #, quantity, facility name, facility address, facility phone number, and contact name. GOJO will direct-ship them to your facility at no charge. In addition, GOJO will do the installation if more than 100 dispensers (combined soap and sanitizer) are ordered.

Hand Sanitizers



PURELL™ Instant Hand Sanitizer

Kills 99.99% of most common germs that may cause illness. Works in as little as 15 seconds. No water or towels needed. Specially formulated with moisturizers to leave hands feeling soft and refreshed. Alcohol based.

A. 4 oz.	34404	\$3.24 ea.
B. 8 oz. Pump	34235	\$6.35 ea.
C. 12 oz. Pump	34405	\$7.12 ea.
D. 2 L Pump.....	34379	\$34.50 ea.
E. 2 L Wall Bracket.....	90848	\$14.15 ea.

PURELL Instant Hand Sanitizer with Aloe

F. 4 oz.....	34476	\$3.24 ea.
G. 8 oz. Pump	34478	\$6.35 ea.
H. 12 oz. Pump.....	34477	\$7.12 ea.



PURELL™ Push-Style Dispensers

Dove Gray with glossy finish. ADA compliant for away-from-sink placement. Lifetime guarantee.

A. 1,000 mL Instant Hand Sanitizer Dispenser Compact design optimizes wall space.	90716	\$20.20 ea.
B. Instant Hand Sanitizer Refill 1,000 mL	34338	\$13.40 ea.
C. Instant Hand Sanitizer with Aloe Refill 1,000 mL	34475	\$13.40 ea.
D. 1,200 mL Foam Hand Sanitizer Dispenser Small size with high capacity and optional key lock included.	90955	\$84.25 ea.
E. Foam Hand Sanitizer Refill 1,200 mL	34470	\$36.85 ea.



PURELL™ Instant Hand Sanitizer Foam

The power of PURELL, in a non-aerosol foaming formula. Kills 99.99% of most common germs that may cause illness. Thick, rich foam formula stays on your hands. Patent-pending, 62% ethyl alcohol formula is free of fluorinated chemicals. Contains moisturizers to help keep skin hydrated.

A. 18 oz. Pump	34473	\$29.85 ea.
B. 1.5 oz. Pump.....	34474	\$5.90 ea.
C. 15 oz. Aerosol	34378	\$18.05 ea.
D. 15 oz. Aerosol Wall Dispensing System.....	90737	\$8.79 ea.



PURELL™ Touch-Free Dispensers

Three C-size alkaline batteries included. Dove Gray with matte finish. Fully ADA compliant, UL/CE registered. 3-year guarantee.

6"W x 10½"H x 4"D		
A. 1,200 mL Touch-Free Dispenser.....	90850	\$46.20 ea.
B. Sanitizing Station Base with "Healthy Hands Start Here" Sign (Dispenser and refills sold separately.)	91021	\$182.50 ea.
C. Instant Hand Sanitizer Refill 1,200 mL	34424	\$22.75 ea.
D. Foam Hand Sanitizer Refill 1,200 mL.....	34469	\$48.20 ea.

PURELL™ Sanitizing Wipes

All the germ-killing benefits of PURELL, in a non-linting, durable wipe. Textured for superior cleaning. Sanitizes hands while wiping away light soils and dirt. Kills 99.99% of most common germs that may cause illness. Convenient and easy to use.

A. 1,200 Count Refill Pouch	49213	\$70.65 ea.
B. Wall Dispenser for 1,200 Count	91112	\$59.70 ea.

NEW!

Alcohol Free!



School Health Brand Alcohol-Free Hand Sanitizer

School Health brand alcohol-free hand sanitizers naturally moisturize the skin while killing 99.99% of germs. Using an FDA approved active ingredient, BAC, these products create significant “extended microbe killing power” and are an acceptable replacement to hand washing. School Health Brand alcohol-free hand sanitizer products are non-toxic, non-flammable, and skin soothing.

64 oz. Bottle	1035052	\$23.50 ea.
Wipes, 72/pkg.....	1035053	\$4.99 pkg.

School Health Brand Instant Hand Sanitizer

School Health Brand Hand Sanitizer kills germs that cause common illnesses and diseases. Kills 99.9% of bacteria.

Features:

- Contains 62% ethyl alcohol
- Excellent germ-fighting solution
- Fragrance free
- Superior efficacy compared to soap and water
- No dyes

64 oz.	34833	\$18.00 ea.
-------------	--------------	-------------



Sani-Hands® ALC

Antimicrobial hand wipe with 99.99% effective reduction against gram positive and gram negative bacteria, fungi, and yeast. Physically removes bacteria and soil from hands.

135/can.....	49177	\$9.63 ea.
220/can	49206	\$13.20 ea.
Individually Packaged Towelettes		
100/box	49178	\$8.91 box



HOLDS UP TO FIVE CANISTERS!

Deluxe Multi-Canister Floor Stand

Place in entryways and other high-traffic areas. Holds up to five canisters.

.....	1007186	\$327.00 ea.
-------	----------------	--------------

Kleenhanz® Alcohol-Free Towelettes

When you wipe your hands with a Kleenhanz towelette, the friction is cleaning your hands while the germ and bacteria-killing compounds are working. Your hands will feel moisturized and will have germ-killing protection for over two hours after each use.

- Alcohol-free hand cleaning and sanitizing wipe that kills 99.99% of germs and bacteria on contact
- Effective against many viruses, like H1N1, Hepatitis, Herpes, HIV, Chlamydia, Influenza A., and dangerous bacteria like MRSA and E. Coli
- Non-hazardous/non-toxic formula uses two active quaternary ammonium compounds, benzalkonium chloride, and benzethonium chloride
- Antimicrobial and hypoallergenic
- Does not leave hands feeling dry and itchy
- Freshly scented and lightly moistened
- Can be very effective as a germ, bacteria, and virus killing surface wipe

A. 70/can.....	49224	\$5.45 ea.
B. 30/can	1007224	\$3.66 ea.
C. 25/box, Individually Wrapped	1007223	\$3.60 box

Kleenhanz® Alcohol-Free, Antiseptic Towelettes

Container is ideal for classrooms, clinics, locker rooms, field trips, and outdoor activities and has a convenient handle to carry almost anywhere you need Kleenhanz. The non-hazardous/non-toxic formula does not sting on open wounds and features a pull top that seals for freshness and safety.

D. 500 ct.....	49225	\$38.90 ea.
-----------------------	--------------	-------------



WOUND & INFECTION

Antibacterial Soap



Liquid Dial® Gold Antimicrobial Soap

Broad spectrum antimicrobial effectiveness with added skin conditioners for mildness.

2.5 oz. Bar	44050	\$0.57 ea.
7.5 oz. Pump	34007	\$4.33 ea.
16 oz. Pump.....	34454	\$8.67 ea.
Gallon	34073	\$26.00 ea.
1 Liter Dispenser	90000	\$16.55 ea.
Cartridge for Dispenser	34054	\$12.90 ea.

Dial® Basics Hypoallergenic Soap with Aloe

A mild, pleasing soap that is gentle on the skin. Dermatologist-tested and hypoallergenic, Dial Basics rinses clean and is excellent for frequent hand washing. Light, fresh scent. Meets the criteria of Green Seal GS-41/ Environmental Choice CCD-104.

7.5 oz. Liquid Pump	34605	\$3.26 ea.
16 oz. Liquid Pump.....	34608	\$4.92 ea.
Gallon Liquid	34609	\$23.00 ea.
1 Liter Liquid Dispenser, Translucent Ice	90000	\$16.55 ea.
1 Liter Liquid Refill Cartridge	34606	\$8.90 ea.
1 Liter Foam Dispenser, Smoke Grey.....	91113	\$11.10 ea.
1 Liter Foam Cartridge	34607	\$15.15 ea.



Liquid Dial® with Moisturizers and Vitamin E Antimicrobial Soap

Broad spectrum antimicrobial effectiveness with extra moisturizers and conditioners to protect against dry skin. Ideal for frequent hand washing.

7.5 oz. Pump	34190	\$5.90 ea.
1 Liter Cartridge for Dispenser.....	34192	\$16.20 ea.
1 Liter Dispenser	90000	\$16.55 ea.



Dial Complete® Foaming Soap

Patented Activated Triclosan™ formulation provides 25 times better germ-kill than other antimicrobial soaps. Effective against MRSA, VRE, Streptococcus, E. Coli, and Salmonella. Its hypoallergenic foam is excellent for very frequent hand washing and contains soothing skin conditioners like aloe and glycerin.

7.5 oz.	34321	\$7.33 ea.
1 Liter Refill Cartridge.....	34491	\$18.60 ea.
1 Liter Dispenser, Smoke	90974	\$13.25 ea.
1 Liter Dispenser, Blue	90975	\$13.25 ea.



VioNex® Antimicrobial Skin Wipe Towelettes

Kills germs; scrubs and cleans the skin without water. Contains PCMX and is final-formula tested. Textured towel is sturdy enough for scrubbing. Safely and effectively removes blood or body fluids from any skin surface. Meets OSHA standard for use as an "antiseptic towelette".

5" x 7", 50/box **49028** \$14.70 box

VioNex® Antimicrobial Liquid Soap

Formulated to be gentle and non-irritating for hand washing 30-50 times per day. Contains skin conditioners and emollients to help relieve dry skin. Active ingredient chloroxylenol. Low skin irritation potential with 99.94% germ reduction in 30 seconds.

18 oz. Pump..... **50078** \$16.45 ea.
 18 oz. Wall Mount **90248** \$11.05 ea.
 Gallon **34225** \$53.00 ea.



A



B



C



D

A. 3M Avagard™ D Hand Antiseptic

Waterless, instant hand antiseptic feels like a moisturizer, doesn't leave hands sticky or affect glove performance. Kills more than 99% of harmful bacteria within 15 seconds; effective against VRE.

16.9 oz..... **34334** \$18.70 ea.
 3 oz..... **34333** \$5.25 ea.

B. A.B.H.C. Instant Hand Sanitizer

2 oz..... **34397** \$1.75 ea.
 4 oz..... **34398** \$2.74 ea.
 8 oz. Pump..... **34399** \$4.98 ea.

C. Iso-Quin

Hand washing liquid used to protect against the spread of germs or to dry oily skin before taping.

Pint **34066** \$12.95 ea.
 Gallon **34067** \$60.60 ea.

D. Hibiclens®

The hospital preferred antimicrobial skin cleanser containing 4% CHG in a non-irritating formulation for up to six hours of continuous protection. Hibiclens is effective against a wide range of bacteria, viruses, and fungi including MRSA, Herpes, and Swine Flu. Its efficacy is not compromised in the presence of organic materials such as blood, sweat, and exudate.

Gallon **34079** \$78.40 ea.
 Pump for Gallon **90044** \$3.58 ea.
 32 oz..... **34083** \$23.20 ea.
 Pump for 32 oz. **90032** \$2.85 ea.
 16 oz. with Foaming Pump..... **34103** \$18.15 ea.
 Pump for Foaming 16 oz..... **90014** \$2.83 ea.

Skin Care, Prep Pads & Masks



Spray, 2 oz.....	1031117	\$6.52 ea.
Foam, 2 oz.	1031107	\$6.99 ea.
Fragrance-Free Foam, 2 oz.	1031109	\$6.99 ea.
Foam, 4 oz.	1031111	\$9.36 ea.
Fragrance-Free Foam, 4 oz.	1031113	\$9.36 ea.
Foam, 8 oz.	1031115	\$14.93 ea.

Theraworx Protect Hygiene Technology

Theraworx Protect Hygiene Technology for when clean is not enough. Cleans the skin with a highly specialized formulation, supports the skin's natural function and protects it with powerful ingredients.

Theraworx technology is clinically designed to:

- Optimize the skin's natural function
- Supports the skin's healthy flora
- Create a low Ph, acidic environment

Wipes

2/pkg.	1031122	\$3.61 pkg.
Fragrance Free, 2/pkg.	1031124	\$3.61 pkg.
8/pkg.	1031103	\$7.13 pkg.
Fragrance Free, 8/pkg.	1031105	\$7.13 pkg.
50/pkg.....	1031101	\$12.30 pkg.



School Health Brand Sterile Alcohol Prep Pads

200/box49251	\$3.27 box
---------------	---------------	------------



Hygea® Sterile Saline Wipes

Ideal for post-operative eye care, wet to dry dressing changes in the hospital and home, and cleansing the exterior areas of the eye in newborns. Each lint-free applicator is saturated with an isotonic solution of sodium chloride.

24/box49142	\$6.54 box
--------------	---------------	------------



PDI Alcohol Prep Pads

200/box49003	\$7.01 box
---------------	---------------	------------

PDI Castile Soap Towelettes

100/box49060	\$6.02 box
---------------	---------------	------------



Ear Loop Face Mask

These 3-ply fluid-resistant face masks are fiberglass free and designed to eliminate fogging. They offer bacteria filtration, with efficiency at 3.0 microns. Aluminum nose guard for extra comfort.

50/box21354	\$10.30 box
--------------	---------------	-------------

Molded Face Mask

Molded face masks are manufactured of soft, cool, comfortable materials; fiberglass free; fluid resistant, flared soft edges to fit all facial contours; adjustable aluminum nose piece; dual head straps for tight facial seal. Not made with natural rubber latex.

50/box21355	\$14.10 box
--------------	---------------	-------------

FREE SHIPPING at SchoolHealth.com/SportsMed

Get FREE SHIPPING on your online order over \$100! Go to the back cover for Free Ship Online code. Can only be used once per customer. Expires 12-31-20.



EZ Cleans Plus™ Kit

Contents:

Red Z™ Solidifier, P.A.W.S.™ antimicrobial hand wipe, germicidal solution, wiper pads, vinyl gloves, scoop/scraper, biohazard red bag, and instructions.
**90959** \$8.95 kit



Universal Precautions Compliance™ Kit

Contents:

Red Z™ Solidifier, P.A.W.S.™ antimicrobial hand wipe, germicidal solution, wiper pads, vinyl gloves, combination mask/face shield, scoop/scraper, apron, biohazard red bag, identification tag, and instructions.
**90960** \$15.90 kit



Mini Clean-Up Kit™

OSHA compliant instant spill kit ideally sized for the classroom.

Contents:

(1) Bleach packet (2) Non-latex gloves
 (2) Large absorbent towels (1) Red biohazard bag with twist tie
**90209** \$4.14 kit



Blood Buster™

This premium, ready-to-use formula removes blood and organic stains from uniforms, clothing, carpets, and upholstery.

4 oz.....**50034** \$9.80 ea.
 32 oz. Spray.....**50060** \$23.95 ea.



RED Z™ Fluid Control Solidifier

Quick and easy clean-up and containment of body fluid spills. High absorption ratio, superior gel strength, and excellent fluid retention. Contains chlorine.

5 oz. Shaker Top.....**44215** \$11.25 ea.
 11 oz. Shaker Top.....**44216** \$22.65 ea.
 Bio Scoop and Scraper
 50/box.....**90311** \$42.75 box



CareBag Vomit Bag with Super Absorbent Pad

The CareBag Vomit Bag will effectively catch and contain all vomit mess and avoid the soiling of clothes, bus/car, carpet or floor! It is a medical grade bag equipped with a unique, super-absorbent pad which turns up to 16 oz. of emesis into a gel within seconds. Designed for both children and adults, it is an essential addition to a first aid kit.

20/box.....**1002657** \$22.20 box



Voban® Vomit Absorbent

Effective on vomit, pet accidents and other spillage. Fortified with enzymes to attack and quickly break down the source of odors.

1 lb. bag.....**44051** \$4.02 bag
 1 lb. bag, 24/cs.....**44503** \$83.60 cs.

Infectious Waste Disposal & Sharps Containers



Sharps® Syringe Container

Thick polypropylene material that can be autoclaved or incinerated. Safety handle to avoid physical contact. Snap-on lids. Infectious waste containers are labeled in Spanish and English. Meets California Code Title 22 attachment A-2. Clear, see-through lids help avoid over-filling.

- 1-Quart Capacity, 20 Syringes **90080** \$6.75 ea.
- Metal Wire Holder (for 90080) **90106** \$28.15 ea.
- 1-Gallon Capacity, 150-180 Syringes **90081** \$10.05 ea.
- Metal Wire Holder (for 90081) **90107** \$34.25 ea.
- 2-Gallon Capacity... **90968** \$13.85 ea.
- 3-Gallon Capacity ... **90969** \$16.90 ea.



Sharps® 20 Gallon®

The Sharps Medical Professional Sharps Disposal By Mail System completely eliminates the need for that costly, inconvenient pickup service, without having to change your container style. At the same time, it allows you to take advantage of the hottest medical waste disposal phenomenon—mailback.

- **90029** \$302.50 ea.



A B C



D E

Sage Sharps Containers

They come in a variety of container sizes and openings which allows for disposal of other sharps, such as lancets, tubing, and syringes. Containers lock for final disposal.

- A.** 2.2-Quart **90838** \$5.15 ea.
- B.** 1-Quart **90837** \$3.89 ea.
- C.** 8-Quart **90834** \$9.97 ea.
- D.** 5-Quart Wall Unit with Glove Dispenser (comes complete with one 5-quart container) **90835** \$82.65 ea.
- E.** 5-Quart Container for Wall Unit **90836** \$9.82 ea.

Need higher resolution for 2021

Adhesive Biohazard Labels

- 3" x 5", 10/pkg. **90131** \$4.96 pkg.



Sharps® Transport Tube™

Has been created for simplified management of used sharps, such as needles, syringes and lancets. The ideal solution for “on-the-go” individuals who self inject drug therapies and travel, live or work in environments where short-term containment of used sharps is necessary.

- 6/box. **91096** \$85.80 box



Infectious Waste Hamper

Durable 1", chrome-plated steel stand is pedal operated for hands-free use. Plastic-covered metal rim reduces bag spillage. Comes with white, poly-coated, plated metal cover for combined safety and durability. 3" ball bearing swivel casters, two of which lock.

- **90128** \$268.00 ea.

Red Infectious Waste Bags (Not Shown)

- 31" x 43" 10/pkg. **21444** \$7.00 pkg.
- 200/pkg. **21183** \$130.00 pkg.
- 24" x 24" 10/pkg. **21112** \$4.04 pkg.
- 12" x 12", (2 mil thick) 50/pkg. **21034** \$17.60 pkg.

Medical Waste Disposal By Mail System®

Each kit contains all the components needed for collection and transportation of regulated medical waste, such as needles, syringes, and lancets. Step-by-step instructions, waste shipping containers, prepaid and pre-addressed shipping labels, prepaid disposal and tracking documents are included.

- 1-Quart (holds 50-70 1 cc syringes) **1003726** \$52.25 ea.
- 1-Gallon (holds 210-230 1 cc syringes) **1003725** \$67.75 ea.
- 2-Gallon (holds 440-460 1 cc syringes) **1003727** \$92.85 ea.
- 3-Gallon (holds 700-720 1 cc syringes) **1003728** \$128.50 ea.
- 5-Gallon System (for red-bag medical waste) **1003729** \$192.00 ea.



Therapeutic Modalities

Hot & Cold Packs	98-99	Whirlpool Tables & Accessories	113
Ice Bags & Accessories	100	Stimulators & Ultrasound	114-117
Plastic Bags	101	Deep Oscillation Therapy	118
Wraps	102	Stimulator & Ultrasound Electrodes	119
Hot & Cold Therapy	103-104	Stimulators & Ultrasound Accessories	120
Heat Therapy	105-107	Blood Flow Restriction & Stimulators	121
Freezers, Chilling Units & Accessories	108	Cold/Hot Systems	122
Ice Makers	109-111	Compression Therapy	125
Whirlpools	112	Recovery Furniture	126

Hot & Cold Packs

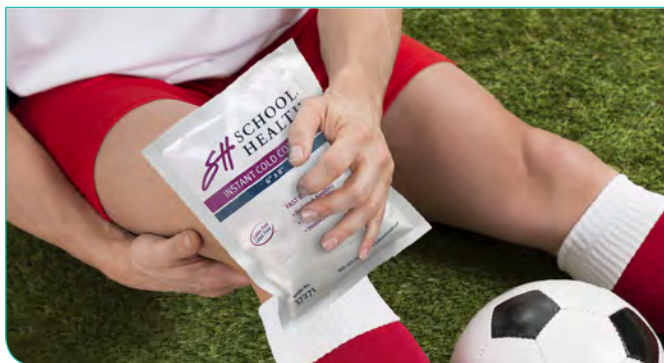

School Health Brand Instant Cold Pack

Instant cold packs relieve stiff necks, backaches, headaches, and toothaches; help to lower the body temperature in case of fever; and are great for minor sporting injuries. Single use only.

Features:

- No refrigeration
- Squeeze to activate
- Ideal for sprains
- Reduces swelling
- Easy to use—just squeeze to activate

16/case

5" x 7"	37270	\$11.65 cs.
6" x 8"	37271	\$15.9 cs.



A



B



C



D

APPLY DIRECTLY TO SKIN!



E



F

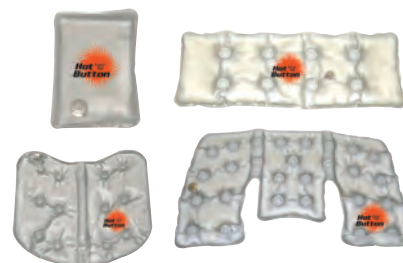

G

A. Kwik Kold® Instant Cold Packs

X-Small, 5" x 5½"		
50/case.....	1032794	\$39.25 cs.
Medium, 5½" x 6"		
16/case.....	37006	\$15.99 cs.

B. Instant Heat Pack

Instant hot pack provides soothing warmth
Flexible material conforms to body contours.
5" x 9", 24/case
..... **1032795** \$16.5 cs.

C. Instant Hot Pack

Provides instant heat treatment by simply squeezing to activate. It can be used as a moist heat application by encasing in a damp towel.
6" x 8"..... **1008279** \$1.4 ea.

D. InstaKool™

Delivers immediate cold therapy for first aid, providing comfort and reducing swelling after an injury. This revolutionary formula is the first instant cold pack with national security in mind. Ammonium Nitrate-free; this innovative formula rivals the temperature ranges of previous cold packs. Exceeds ANSI standards.

5" x 6"	37131	\$1.01 ea.
5" x 7", 16/case.....	37139	\$16.5 cs.
6" x 8", 16/case.....	37138	\$19.5 cs.
6" x 8", 24/case.....	37213	\$25.8 cs.

E. Hot/Cold Gel Therapy Packs

Insulated on one side. Therapy packs maintain an even temperature over the entire pack, are leak-proof, and contain no liquids or dyes. Therapy packs are biodegradable and contain only non-toxic ingredients. Being reusable, these packs save you money!

24/case		
4½" x 7"	1032797	\$24.9 cs.
6" x 9"	1032796	\$38.25 cs.

F. Blue Easy Sleeves Ice Pack Covers

Disposable, non-woven blue covers designed to prevent cross-contamination when using reusable hot/cold packs by more than one patient. Single-use.

4" x 7"	37178	\$0.26 ea.
4" x 10".....	37179	\$0.29 ea.
6" x 10".....	37180	\$0.35 ea.

G. Relief Pak® Hot Button® Reusable Instant Hot Compress

The re-usable Hot Button hot pack instantly becomes hot for at least 30 minutes once the button inside the pack is activated. Re-usable pack is ready for a future activation by boiling it. This can be repeated at least 100 times. The contents are not harmful; they are common non-toxic food additives.

Small, 3.5" x 5.5"		
.....	1031650	\$7.99 ea.
Standard, 5" x 15"		
.....	1031651	\$12.99 ea.
Neck, 11" x 17"		
.....	1031652	\$18.99 ea.
Oversize, 10" x 17"		
.....	1031653	\$15.99 ea.

Not made with Natural Rubber Latex.

SH School Health Brand Reusable Hot/Cold Packs

- Reusable gel compress
- Microwave for heat therapy, freeze for cold therapy
- Conforms to shape of injury site
- Remains flexible when activated
- Ideal for emergency first aid
- Non-toxic—no dye added

***Buy a Case and SAVE!**



4" x 6"	37181	\$0.85 ea.	5" x 8¼"	37183	\$1.74 ea.
4" x 6", 24/case	37188	\$16.55 cs.	5" x 8¼", 12/case	37201	\$19.5 cs.
4" x 9"	37182	\$1.56 ea.	Combo Pack, (12) 4" x 9", (12) 5" x 8¼"		
4" x 9", 12/case	37200	\$16.95 cs.	24/case	37196	\$33.3 cs.



A



B



C



E

A. Thermo-Kool® Hot/Cold Compress

Reusable and non-toxic, this compress stays flexible at sub-zero temperatures. Conforms to contours of the treated area. Provides heat or cold for up to 30 minutes.

3" x 5"	37277		1-124	Case of 125	\$1.07 ea.	\$1.03 ea.
4" x 6"	37064	\$1.25 ea.	1-49	Case of 200	\$1.21 ea.	\$1.17 ea.
4" x 9"	37023	\$1.82 ea.			\$1.76 ea.	\$1.7 ea.
6" x 9"	37020		1-29	Case of 30	\$2.26 ea.	\$2.18 ea.
8½" x 10½"	37072		1-11	Case of 12	\$4.84 ea.	\$4.67 ea.
Cervical, 4" x 18"	37073	\$5.77 ea.				
Finger Pack, 5" x 4"	37019	\$2.18 ea.				

B. JACK FROST Gel Pack

Ideal for recurring hot and cold therapy needs. One-sided insulation directs therapy to the intended area while reducing temperature loss. Reusable.

Insulated On One Side						
4½" x 7"	37207	\$1.95 ea.				
6" x 9"	37208	\$2.64 ea.				
4½" x 10½"	37209	\$2.43 ea.				
Soft, Reusable Cold Pack						
2½" x 5"	37210	\$0.83 ea.				

***Buy a Case and SAVE!**

C. Cryopak Flexible Ice Blanket

Soothes injuries, eases pain, and stays colder longer than gel packs or ice. Store in the freezer. No messy water or residue. Lightweight, with less bulk, less space, less waste. Flexible even when frozen. Reusable. 36 pouches to a sheet.

8.75" x 16.85"	37169	\$4.31 ea.
----------------------	--------------	------------

D. 360° Premium Hot & Cold Therapy Sleeves

Designed to gently roll on and stay in place, hands free. The 360-degree coverage treats the entire injured area, delivering hot or cold where it's needed. Materials stay ultra soft when chilled or heated. Reduces treatment time, provides faster pain relief, keeps swelling to a minimum, and increases overall healing. Non-toxic and reusable.

Finger		
1" Diam. x 4" L	37311	\$14.3 ea.
Small (Hand/Wrist/Foot)		
4" Diam. x 6" L	37312	\$23.4 ea.
Medium (Elbow/Foot/Ankle)		
5" Diam. x 6" L	37314	\$29.85 ea.
Large (Leg/Knee)		
6" Diam. x 6" L	37313	\$34 ea.
Extra Large (Large Knee)		
7" Diam. x 8" L	37315	\$42.85 ea.

E. BLUEICE® Flex Gel Pack

Non-invasive, drug-free form of therapy insures flexibility even when frozen for extensive periods of time. Non-toxic and non-caustic.

3" x 5"	37193	\$1.05 ea.
5" x 7"	37276	\$1.9 ea.

Not made with Natural Rubber Latex.

Ice Bags & Accessories

COMPARE & SAVE!



SH School Health Brand Ice Bags

This heavy-duty polyethylene bag is sturdy and very strong with a flat bottom seal with no side seams to break open. Leak proof and puncture resistant. No double bagging required. 1 mil thickness.

10" x 18", 1 mil
1,500/roll **21633** \$104 roll

Clear Acrylic Heavy Duty Dispenser

Holds one roll of ice bags securely and easily mounts to a wall with 4 molly bolts. Very clean and attractive in any athletic training room.

..... **91454** \$151 ea.



Mueller® Ice Bags

10" x 18", 1 mil
1,500/roll **21586** \$109.99 roll

Mueller® Ice Bag Dispenser

Heavy duty dispenser is coated to resist scuffing.

..... **91398** \$30.99 ea.

Extra-Heavy Duty Ice Bags (Not Shown)

The heaviest ice bag on the market. Leak proof and puncture resistant. No double bagging required.

18" x 12", 2.5 mil (high density)
375/roll **21215** \$144.99 roll

ELINE Ice Bags (Not Shown)

12" x 20", 2 mil
1,000/case **21218** \$114 cs.

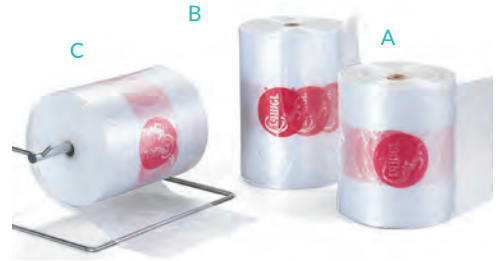

Cramer® Heavy Duty Ice Bags

A. 9¾" x 18"

Made of rugged polyethylene—no need for double bagging. 1 mil high density.

1,500/roll **21144** \$124.99 roll

B. 12" x 24"

750/roll **21251** \$144.99 roll

C. Ice Bag Dispenser

Made of stainless steel, its 16" frame allows for mounting to walls. Comes complete with hardware.

..... **90407** \$71.99 ea.

Ice Bags (Not shown)

8" x 18", 0.038 mil
100/box **21031** \$51.99 box

Heavyweight 12" x 20", 0.1016 mil
100/box **21037** \$102.99 box

8" x 4" x 18", 1.25 mil
1,000/box **21115** \$82.8 box



Pull-n-Pack® Ice Bags

This unique system solves problems commonly associated with ice bags. Compared to most ice bags, Pull-n-Pack® Ice Bags provide superior protection against leaks and breakage. Convenient one-bag-at-a-time dispensing. Easy-to-use, self-opening bags.

Pull-n-Pack® Clear

15" x 20" (3 gallon)		1-11 Rolls	Case of 12
50 bags/roll 21245	\$3.99 roll		\$3.79 roll
650 bags/roll 21246	\$37.99 roll		\$36.09 roll

Pull-n-Pack® XTREME

15" x 20"		1-11 Rolls	Case of 12
250 bags/roll 21253	\$25.99 roll		\$24.69 roll

Pull-n-Pack® Accessories

48" Floor Stand **90431** \$131.99 ea.



Ice Bag Sealer

Seals ice bags in a flash, without the mess. Convenient and portable.

With Tape **90861** \$52.99 ea.
Replacement Tape for Ice Bag Sealer **28235** \$5.99 roll

Zipper® Seal-Top Reclosable Bags

2 mil Clear Bags, 100/pkg.

3" x 3".....	21337	\$1.65 pkg.
4" x 4".....	21338	\$2.54 pkg.
4" x 6".....	21422	\$2.72 pkg.
5" x 7".....	21339	\$3.44 pkg.
5" x 8".....	21389	\$4.16 pkg.
6" x 8".....	21390	\$4.75 pkg.
6" x 9".....	21340	\$5.44 pkg.
7" x 8".....	21388	\$8.16 pkg.
8" x 10".....	21391	\$9.36 pkg.
12" x 12".....	21392	\$12.1 pkg.

2 mil Clear Bags with Writing Block, 100/pkg.

3" x 5".....	21344	\$2.57 pkg.
4" x 6".....	21345	\$4.02 pkg.
5" x 8".....	21346	\$5.93 pkg.
6" x 9".....	21347	\$7.05 pkg.

4 mil Clear Bags, 100/pkg.

4" x 4".....	21341	\$4.34 pkg.
6" x 6".....	21342	\$9.03 pkg.
6" x 9".....	21343	\$10.45 pkg.



Ziploc® Sandwich Bags

A. Pint

6½" x 5⅞", 1.5 mil

40/box.....	1003748	\$4.66 box	1-11 Boxes	Case of 12	\$4.5 box
90/box.....	1003749	\$5.65 box			\$5.45 box

6½" x 3¼", 1.5 mil

90/box.....	21220	\$5.9 box			\$5.69 box
-------------	--------------	-----------	--	--	------------

Quart

C. 7" x 8", 1.75 mil

500/box.....	21595	\$54.65 box			—
--------------	--------------	-------------	--	--	---

Gallon

10⅞" x 11", 1.7 mil

19/box.....	21356	\$4.8 box			—
-------------	--------------	-----------	--	--	---

E. 10⅞" x 11", 1.75 mil, Double Zipper

250/box.....	21593	\$46.05 box			—
--------------	--------------	-------------	--	--	---



A



B



C



D



E



F

Ziploc® Freezer Bags

Pint

7" x 5¼", 2.7 mil

20/box.....	21114	\$5.07 box	1-11 Boxes	Case of 12	\$4.89 box
-------------	--------------	------------	-------------------	-------------------	------------

Quart

7" x 8", 2.7 mil

40/box.....	21003	\$9.55 box			\$9.22 box
-------------	--------------	------------	--	--	------------

Gallon

10⅞" x 11", 2.7 mil

30/box.....	21133	\$8.75 box			\$8.44 box
-------------	--------------	------------	--	--	------------

F. 10⅞" x 10¾", Double Zipper

250/box.....	21594	\$51.45 box			—
--------------	--------------	-------------	--	--	---

Wraps



Econoline Exoclear® Wrap

Clearly the most economical, practical, multi-use wrap available. Its hand-held size makes it less cumbersome, requires no handle, and is easy to store. Each roll contains 500 feet of Exoclear® or 6,000 feet per case. 0.90 mil thickness.

12 rolls/case**21214** \$42.4 cs.

School Health Master Wrap (Not Shown)

Each roll is 3" x 1000 feet, 0.90 mil thickness.

With Handle, 18 rolls/case.....**21191** \$145.5 cs.
 With Handle, 6 rolls/case.....**21192** \$44.99 cs.
 Without Handle, 6 rolls/case.....**21193** \$39.99 cs.
 Handle Dispenser.....**90228** \$9.99 ea.

COMPARE & SAVE!



Econo Wrap

Fits Flexi-Wrap handle. High-quality, self-adhering plastic wrap. 0.80 mil thickness.

3" x 650', 12 rolls/case
**21627** \$54.99 cs.
 4" x 650', 6 rolls/case
**21628** \$50.99 cs.
 6" x 650', 6 rolls/case
**21629** \$59.99 cs.



Flex-i-Wrap™

4" wide plastic film that quickly secures ice packs or bandages in place for instant compression in the critical phase of a trauma. Handle has a built-in brake to help control the amount of compression. Roll is 4" wide x 650' long, 0.80 mil thickness.

With Handle, 6 rolls/case.....**21136** \$64.99 cs.
 Without Handle, 6 rolls/case.....**21137** \$63.99 cs.
 Handle Dispenser.....**90134** \$8.99 ea.

Flex-i-Wrap™ Colors

Allows athletic trainers to apply treatment or compression, without sacrificing visibility of the injury. Great for applying cold therapy products or compression to any injury. Film is self-adhering, 4" plastic film.

Without Handle, 6 rolls/case
 Blue.....**21330** \$75.99 cs.
 Red.....**21331** \$75.99 cs.



Econo Wrap Plus with Handle

High-quality, self-adhering plastic wrap. This dispenser product is lightweight and well balanced. Includes cushion handle. 0.80 mil thickness.

4" x 650', 6 rolls/case
**21631** \$56 cs.
 6" x 650', 6 rolls/case
**21632** \$60 cs.



Pro Toe Covers

Developed by an athletic trainer to protect the toes or fingers when contrast bath and ice therapy is prescribed for the foot or hand. Fits snugly over the toes or fingers to retain the body heat while preventing discomfort due to the contrasting temperature changes. Made of neoprene rubber with nylon facing. The PRO 14 Digit Cover will not impede circulation.

4/Pack

Large **1006653** \$22.99 pkg.
 X-Large..... **1006654** \$22.99 pkg.



AnkleAid

The first water submersion device designed specifically for ankle and foot therapy. There is nothing on the market that compares to it.

- **Therapeutic**—AnkleAid is designed specifically as a therapeutic device for people with ankle and foot injuries/conditions.
- **Toes Out**—Toes are less tolerant to extreme temperatures, so AnkleAid keeps the majority of the foot in the water while keeping the toes out. The result is more effective and more comfortable therapy.
- **Functional**—AnkleAid can be used for both cryo/cold and thermal therapy. For cold therapy, just add the appropriate amount of water and ice. For heat therapy, use the desired water temperature with or without Epsom salt.
- **Comfortable**—AnkleAid is designed to put the foot at the optimal angle for maximum comfort while submersed in the water.
- **Portable**—AnkleAid is small and light enough to be used anywhere in the house, or it can easily be taken to the gym, work, school, or therapy.
- **Easy-to-use**—It is as simple as filling AnkleAid with the appropriate amounts of ice water or hot water. However, always consult a doctor for the temperature and duration that is right for the specific injury or condition.
- **Affordable**—Compared to other therapies that involve compression, AnkleAid is a fraction of the cost.

.....**37432** \$54.99 ea.



Morris Boot

Provides a superior enclosure for ice and eliminates the mess associated with icing while enabling portability and mobility. The Boot can be used in almost any setting and is re-usable, compact, lightweight, clear, and durable.

Large (Single)..... **37280** \$7.49 ea.
 Large (Case of 20) **1006271** \$127.99 cs.
 X-Large (Single)..... **37281** \$7.49 ea.
 X-Large (Case of 20) **1006272** \$144.99 cs.

Morris Wing

A multi-chambered containment system made especially for areas like the shoulder, & upper extremity, the knee and thigh, the back and hard-to-fit anatomy.

Morris Wing (Single) **1006254** \$7.49 ea.
 Morris Wing (Case of 20)..... **1006270** \$137.99 cs.



Mueller® Ice Bag Wrap

Soft, adjustable ice bag wrap is ideal for applying cold therapy to small and large body parts. Long straps provide a custom fit with firm, comfortable compression to help relieve swelling and bruising.

.....**37251** \$23.99 ea.

FREE SHIPPING at SchoolHealth.com/SportsMed

Get **FREE SHIPPING** on your online order over \$100! Go to the back cover for Free Ship Online code. Can only be used once per customer. Expires 12-31-20.

Hot & Cold Therapy



A



B



C

A. Pro-Tec IceUp Portable Ice Massager

Offers immediate deep tissue relief anywhere. Features comfort grip barrel for controlled ice massage. Ice Grippers allow full range of massage pressure. Leak-proof design. Push up plunger to expose ice. Insulated carry cooler. Stays frozen up to 10 hours. Effective treatment in 5–7 minutes.

.....37076 \$24.99 ea.

B. The CRYOCUP™

Deliver an 8–12 minute ice massage. Made of unbreakable polyethylene. Cup is reuseable, compact, and the ideal size to be taken to sporting events in a cooler for on-the-spot treatments.

.....37076 \$10.99 ea.

C. The Acuforce 3.0i

Developed during the 2002 baseball season, this product provides highly effective cryotherapy. Weighing in at 3 lbs., it forms a large ice surface under the tool to perform long-lasting therapy. The weight of the tool removes the need to apply pressure during treatment. The padded handle allows the therapist's hands to remain warm while working.

.....90530 \$86.99 ea.



D

E

F



G



H

I

D. Economy Dry Heating Pad

Three heat settings, switch with nightlight.

.....35000 \$23.8 ea.

E Moist/Dry Heating Pad

Three heat settings, rotary switch, washable cover and moist heat sponge cloth.

.....35033 \$29.05 ea.

F. Deluxe Heating Pad

Same as 35001, but with a push-button switch and velour cover.

.....35002 \$41.5 ea.

G. Therabath® Paraffin Heat Therapy System

Easy-to-use, fast, and effective. Heat penetrates deeply and effectively to relieve stiff and aching muscles. 6 lbs. of Theraffin Wax included. Exclusive limited lifetime guarantee.

Therabath Heat Therapy System39004 \$274.99 ea.

Theraffin Therapeutic Paraffin 6 lbs., Scent-Free
.....44214 \$38.6 ea.

H. WaxWel® Paraffin Bath Kit

WaxWel paraffin unit for soothing paraffin treatment of hand or foot. WaxWel unit is heavy duty for continuous use in high-traffic clinics. The unit has an oversized tank that can accommodate a man's size 12½ foot. The unit is portable and can even be used in the home.

Standard unit includes:

(100) Liners	(1) Bootie
(1) Mitt	(1) 6 lbs. Unscented Paraffin

..... 1006369 \$142.99 ea.

I. WaxWel® Paraffin

WaxWel paraffin bath refills are compatible with all paraffin warmers. WaxWel paraffin is high-quality paraffin with excellent melting characteristics, moistness, and feel. Fragrance free.

1 lb. Blocks, 6/pkg..... 1006371 \$32.99 pkg.

HydraTherm Heating Unit

- Low voltage control—energy efficient and safe
- Five composite dividers
- Digital low water sensor—disengages heating element, and alerts that water is needed
- Isolated from heat packs for safety and pack longevity



HydraTherm Standard

Includes three Standard, three Universal, three Cervical, & three Oversize HydraHeat Packs, Divider System, and Side Shelf

.....*1005686 \$2,079.99 set

HydraTherm Deluxe

Includes Drainage Pump, three Standard, three Universal, three Cervical, & three Oversize HydraHeat Packs, Divider System

.....*1005683 \$2,529.99 set

HydraTherm Heat Pacs

- Polymer material for long-life and cost savings
- Easy to sanitize, wipe with antibacteria solution
- Reliable seam prevents hot pack leakage
- Malleable surface to fit the contours of the body
- Pack absorbs heat, not water, for nearly 45 minutes of therapeutic treatment

- A.** Cervical, 17" x 11"SK1002863 \$39.30 ea.
- B.** Standard, 17" x 11"SK1002864 \$39.30 ea.
- C.** Oversize, 17" x 13"SK1002865 \$41.41 ea.
- D.** Universal, 19" x 5"SK1002866 \$26.33 ea.

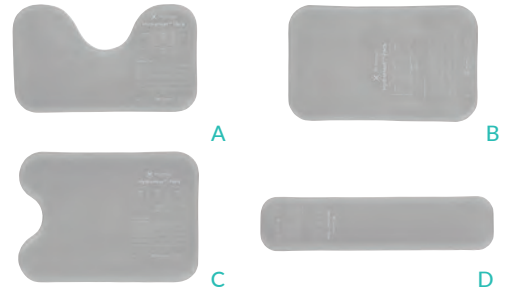

Chattanooga Stationary Hydrocollator® Heating Units

Stainless steel, thermostatically controlled heating units automatically maintain temperature. No plumbing necessary. Plug into a 115 volt AC outlet.

Stationary Hydrocollator® Heating Units		
SH Item #	A. *35004	B. *35003
Chattanooga Model #	E-2	E-1
Dimensions	20"H x 15"W x 13"D	16"H x 13"W x 8"D
Fiberglass Insulation	No	No
Standard Pack Capacity	6 (Included)	4 (Included)
Watts / Volts	1000 W/120 V	1000 W/120 V
Shipping Weight	36 lbs.	19 lbs.
Price	\$1,139.99 ea.	\$539.99 ea.



Chattanooga Mobile Hydrocollator® Heating Units

Transport heated steam packs to any area of your department. Mounted on three-inch swivel type rubber casters for easy mobility. Stainless steel.

Mobile Hydrocollator® Heating Units			
SH Item #	C. *35015	D. *35016	E. *35018
Chattanooga Model	SS-2	M-2	M-4
Dimensions	33"H x 21"W x 16"D	33"H x 27"W x 16"D	33"H x 35"W x 20"D
Fiberglass Insulation	Yes	Yes	Yes
Standard Pack Capacity	8 (Included)	12 (Included)	24 (Included)
Watts / Volts	1000 W/120 V	1000 W/120 V	1500 W/120 V
Shipping Weight	80 lbs.	100 lbs.	166 lbs.
Price	\$1,809.99 ea.	\$1,939.99 ea.	\$3,624.99 ea.



Chattanooga Replacement Heating Element

For all units except M-4.....90289 \$83.99 ea.

* Direct-ship item. Please allow additional time to receive.

Heat Therapy



CHATTANOOGA® ACCESSORIES

Chattanooga Hydrocollator® Steam Packs

A. Multi-Use, 10" x 18".....	.37034	\$32.99 ea.
B. Multi-Use, 10" x 24".....	.37033	\$38.99 ea.
C. Oversize, 15" x 24".....	.37000	\$44.99 ea.
D. Neck Contour, 24" (Most Popular)37001	\$21.99 ea.
E. Half, 5" x 12".....	.37004	\$15.99 ea.
F. Standard, 10" x 12" (Most Popular)37003	\$18.99 ea.
G. Knee/Shoulder, 10" x 20".....	.37032	\$37.99 ea.

Chattanooga Hydrocollator® Pack Covers

Foam-Filled Terry Covers—Gray

Pocket-type. Polyurethane foam inside two layers of terry material.

Standard.....	.37043	\$31.99 ea.
Oversize.....	.37024	\$47.99 ea.

Terry Cover—Gray

For high-volume institutional use. Terry Cover has Velcro® to prevent accidental unwrapping.

Neck Contour37044	\$32.99 ea.
--------------------	---------------	-------------

H. Chattanooga Mobile Stand

This stainless steel cart is versatile, functional, and mobile. Take your SS, E-2, or E-1 unit wherever you need it.

18¾"W x 16¾"D x 19½"H.....	*24044	\$307.99 ea.
----------------------------	---------------	--------------

I. Chattanooga Side Table Rack

Stainless steel surface and two wire shelves add efficiency to models M-4, M-2, SS-2, C-2, C-5, and C-6.

.....	*24045	\$669.99 ea.
-------	---------------	--------------

J. Kool Touch Tongs

These stainless steel tongs with heavy-duty scissor action provide a cool, comfortable grip when handling steam packs.

15"L.....	.36081	\$17.99 ea.
-----------	---------------	-------------

K. Chattanooga Towel Rack

Wall mounted, stainless steel towel rack is a convenient way to dry or store towels and terry covers.

Bracket Size: 2" x 33"90268	\$68.99 ea.
------------------------------	---------------	-------------

Whitehall Thermalator™ Thermal Pack Heating Units

Whitehall's moist heat therapy treatment products are designed to be convenient, while exceeding industry standards (UL and Canadian Standards Association listed).

- Constructed of heavy-gauge stainless steel
- Concealed heating element
- Coved bottom to minimize bacteria buildup
- Lighted, front-mounted on/off indicator switch

A. Whitehall Little Therm

The little Therm is a miniature of the Thermalator with a four-pack punch. This unit features a clean, aesthetic design that occupies a smaller footprint than the standard four-pack. Best of all, this product is economically priced, satisfying the most savvy of shippers.

14¾"H x 13¾"W x 8¾"D.....	*35056	\$389.99 ea.
---------------------------	---------------	--------------



B. T4-S Thermalator™

Space-saving design fits into most office environments, yet provides sufficient space for steam packs. Includes four standard steam packs.

11"W x 8½"D x 15"H	*39029	\$494.99 ea.
--------------------------	---------------	--------------

C. T8-M Thermalator™

Mid-size unit rolls on four, heavy-duty 3" rubber, swiveltype casters—two with brakes to lock the heating unit into position. Includes eight standard steam packs.

18"W x 16"D x 32"H.....	*39031	\$1,657.99 ea.
-------------------------	---------------	----------------

*Direct-ship item. Please allow additional time to receive.



RELIEF PAK® HEATING UNITS

The Relief Pak® Heating Units effectively heats moist heat packs up to 170 degrees in an insulated hot water bath.

- Insulated design keeps heat from dispersing out of the unit, allowing it to retain heat
- Made from durable stainless steel that's perfect for high traffic clinics
- Heating units feature adjustable temperature control

- Orange glowing light illuminates when the unit has reached its desired temperature
- On/off switch glows green when the unit is in use; each unit has a removable 110V plug
- It is best to use moist heat packs at 160 degrees for best results

A. 4/Pack Stationary Heating Unit

Unit Only, No Packs.....	1008199	\$399.99 ea.
Unit with (4) Standard Packs.....	1008213	\$449.99 pkg.
Unit with (3) Standard and (1) Neck Pack... ..	1008189	\$449.99 pkg.
Unit with 4/Pack Stationary Heating Unit with (2) Standard and (2) Neck Packs.....	1008190	\$449.99 pkg.

B. 6/Pack Stationary Heating Unit

Unit Only.....	1008200	\$809.99 ea.
Unit with (3) Standard, (2) Oversized, and (1) Neck Pack.....	1008214	\$924.99 pkg.

C. 8/Pack Mobile Heating Unit

Unit Only.....	1008201	\$1,379.99 ea.
Unit with (8) Standard Packs.....	1008215	\$1,489.99 pkg.
Unit with (4) Standard Packs and (4) Neck Packs.....	1008191	\$1,484.99 pkg.
Unit with (2) Standard Packs, (2) Oversized, and (2) Neck Packs.....	1008192	\$1,469.99 pkg.

D. 12/Pack Mobile Heating Unit

Unit Only.....	1008202	\$1,499.99 ea.
Unit with (12) Standard Packs.....	1008216	\$1,669.99 pkg.
Unit with (3) Standard Packs, (3) Oversized, and (3) Neck Packs.....	1008193	\$1,669.99 pkg.
Unit with (4) Standard Packs, (2) Oversized, and (2) Neck Packs.....	1008194	\$1,669.99 pkg.
Unit with (4) Standard Packs and (4) Oversized Packs.....	1008195	\$1,669.99 pkg.

E. 24/Pack Mobile Heating Unit

Unit Only.....	1008203	\$2,724.99 ea.
Unit with (24) Standard Packs.....	1008196	\$3,029.99 pkg.
Unit with (8) Oversized and (8) Neck Packs.....	1008197	\$3,029.99 pkg.
Unit with (6) Standard Packs, (6) Oversized, and (6) Neck Packs.....	1008198	\$3,029.99 pkg.



Relief Pak® Heating Unit Accessories

Relief Pak® Moist Heat Packs

A. Standard, 10" X 12".....	1006370	\$13.99 ea.
B. Neck, 24".....	1006368	\$15.99 ea.
C. Oversize, 15" X 24".....	1006371	\$32.99 ea.
D. Half Size, 5" X 12".....	1006372	\$11.99 ea.
E. Small Spine, 10" X 18".....	1006373	\$25.99 ea.
F. Large Spine, 10" X 24".....	1006374	\$29.99 ea.
G. Knee-Shoulder, 10" X 20".....	1006375	\$33.99 ea.

H. Relief Pak® Moist Heat Pack Covers

Terry with Foam-Fill

Standard, 20" x 24".....	1006376	\$22.99 ea.
Neck, 9" x 24".....	1006377	\$22.99 ea.
Oversize, 24.5" x 36".....	1006378	\$29.99 ea.

Moist Heat Pack Cover—All-Terry Microfiber

Standard, 20" x 24".....	1006379	\$30.99 ea.
Neck, 9" x 24".....	1006380	\$25.99 ea.
Oversize, 24.5" x 36".....	1006381	\$41.99 ea.

* Direct-ship item. Please allow additional time to receive.

Freezers, Chilling Units, & Accessories



Chattanooga Cold Therapy ColPaC® Mobile Chilling Unit

Large capacity and fast chilling times mean your athletes will never have to wait for a ColPaC®. Requires no plumbing. Simply plug into a standard electrical outlet.

All ColPaC® Chilling Units feature:

- Specially designed interior chilling coils to cool packs faster
- Heavy-duty compressor for more efficient cooling, even with frequent use
- Closed-cell foam insulation for energy efficiency
- Stainless steel, welded construction for long life
- Drain valve for easy cleaning and defrosting.
- 3" (7.5 cm) swivel-type rubber casters for silent, friction-free movement of mobile units
- UL listed

Model C-5

This unit includes six standard and six half-size ColPaC® packs.

Shipping Weight: 165 lbs.

31"H x 27"W x 15½"D *35013 \$3,924.99 ea.



Chattanooga ColPaC® Freezer

An economical way to freeze and store any ColPaC®. Comes stocked with 12 standard ColPaC® packs, making it ideal for busy clinics or athletic training rooms. UL listed.

- Spacious five cu. ft. capacity
- Convenient stainless steel shelves are designed to quickly freeze ColPaC® packs
- Each unit contains stainless steel trays and cup holders, perfect for ice massages

Shipping Weight: 155 lbs.

33½"H x 26"W x 21¼"D *35010 \$1,124.99 ea.



Chattanooga ColPaC®

- Eliminates messy ice packs and soggy towels
- Sizes and shapes fit any body area
- Simply place in chilling unit or freezer

A. Oversize, 11" x 21"	37041	\$40.99 ea.
B. Standard, 11" x 14"	37036	\$23.99 ea.
C. Half, 7½" x 11"	37038	\$14.99 ea.
D. Neck, 23"	37037	\$25.99 ea.
E. Quarter, 5½" x 7½"	37039	\$10.99 ea.



Chattanooga Nylatex Wraps

2½" x 36", 3/pkg.	37008	\$33.99 pkg.
4" x 36", 3/pkg.	37009	\$52.99 pkg.
6" x 36", 3/pkg.	37010	\$67.99 pkg.
Assortment of 9 wraps ranging in size from 2½" x 18" to 4" x 48"		
.....	37065	\$136.99 pkg.

* Direct-ship item. Please allow additional time to receive.

FREE SHIPPING at SchoolHealth.com/SportsMed

Get FREE SHIPPING on your online order over \$100! Go to the back cover for Free Ship Online code. Can only be used once per customer. Expires 12-31-20.



Cube Ice

	Production	Storage	Dimensions	Weight	Item #	Price
A	65 lbs.	26 lbs.	14 ⁷ / ₈ " x 25 ³ / ₈ " x 34"	112 lbs.	35040	\$3,689.99
B	150 lbs.	80 lbs.	26" x 27 ³ / ₈ " x 34"	150 lbs.	35054	\$3,929.99
C	250 lbs.	110 lbs.	30" x 30" x 33"	200 lbs.	35055	\$5,094.99
D	356 lbs.	242 lbs.	22" x 34" x 53"	265 lbs.	35042	\$6,924.99
E	475 lbs.	370 lbs.	22" x 34" x 67"	285 lbs.	35043	\$7,179.99
F	350 lbs.	344 lbs.	30" x 34" x 54"	258 lbs.	35046	\$6,984.99
G	562 lbs.	536 lbs.	30" x 34" x 67"	325 lbs.	35047	\$7,194.99

Flake Ice

	Production	Storage	Dimensions	Weight	Item #	Price
H	510 lbs.	370 lbs.	22" x 34" x 71"	330 lbs.	35044	\$8,389.99

Undercounter Dispensers

	Production	Storage	Dimensions	Weight	Item #	Price
I	58 lbs.	36 lbs.	15" x 38" x 24"	102 lbs.	1035339	\$3,706.00
J	260 lbs.	18 lbs.	15" x 38" x 24"	102 lbs.	1035349	\$8,683.00
K	340 lbs.	80 lbs.	24" x 39" x 28 ¹ / ₂ "	210 lbs.	1035350	\$8,859.00

Countertop Ice and Water

	Production	Storage	Dimensions	Weight	Item #	Price
L . Flake.....	440 lbs.	80 lbs.	24" x 39" x 28 ¹ / ₂ "	210 lbs.	1035345	\$9,030.00

Note: Add 6" height for legs on all machines except countertop dispensers. More units available in 230V and water cooled condenser.

* Direct-ship item. Please allow additional time to receive.

Ice Types



Cube Ice:

- Slow melting—stays in bin longer
- Clear



Flake Ice:

- Dry flakes cool more quickly than other forms of ice
- Molds to any shape
- Ideal for therapeutic use



Nugget Ice:

- Randomly sized bits of ice
- Ice does not stick together—is free flowing at all times
- Ideal for therapeutic use
- Helps drinks stay cool longer



Ice Scoops

Aluminum

38 oz.	90083	\$26.99 ea.
84 oz.	90515	\$40.99 ea.
Plastic	90039	\$13.99 ea.

Ice-o-matic® Ice Makers

NEW!



A



B



C



D



E



F



G

Ice-O-Matic Ice Machines

Since 1952, Ice-O-Matic has worked tirelessly on developing, enhancing, and perfecting the way ice is made. Founder Dave Smith's mission was to offer the best ice machines in the business with a single-minded focus on top-quality ice. To this day, Ice-O-Matic is dedicated to providing simple, reliable, and easy-to-use commercial ice machines.

Harvest Assist provides consistent ice production for the life of the ice maker while reducing energy consumption and increasing capacity.

Pure Ice® exclusively by Ice-O-Matic. Built-in antimicrobial protection for the life of the ice maker inhibits bacteria growth on ice maker surfaces. Ice-O-Matic's optional water filtration system provides protection against unpleasant tastes, odors, and scale formation.

Durable, electroless nickel plating on all evaporator plates ensures reliability.

Constructed from corrosion-resistant stainless steel and fingerprint-proof plastic.

Undercounter Ice Makers

	Production	Storage	Dimensions	Weight	Item #	Price
--	------------	---------	------------	--------	--------	-------

Nugget Ice

A.....	85 lbs.	22 lbs.	14.88" x 33.38" x 25.63"	150 lbs.	*1035344	\$4,203.00
--------	---------	---------	--------------------------	----------	----------	------------

Half Cube Ice

B.....	185 lbs.	70 lbs.	24.5" x 26.27" x 39"	150 lbs.	*1006411	\$4,679.99
C.....	238 lbs.	70 lbs.	24.5" x 26.27" x 39"	150 lbs.	*1006412	\$5,579.99

Stand Alone Ice Makers

	Production	Storage	Dimensions	Weight	Item #	Price
--	------------	---------	------------	--------	--------	-------

Half Cube Ice

D.....	310 lbs.	344 lbs.	30.25" x 31" x 57.5"	260 lbs.	*1006409	\$7,859.99
E.....	620 lbs.	510 lbs.	30" x 31" x 70"	371.5 lbs.	*1006410	\$10,154.99

Flake Ice

F.....	540 lbs.	351 lbs.	22" x 22" x 77"	332 lbs.	*1006413	\$10,249.99
G.....	900 lbs.	510 lbs.	30" x 31" x 77"	371.5 lbs.	*1006414	\$12,734.99

* Direct-ship item. Please allow additional time to receive.



Hoshizaki Ice Makers



Using state-of-the-art technology, every Hoshizaki ice machine is run-tested at the factory and undergoes rigorous quality performance tests, including ice production capacity and energy efficiency.

Crescent Cuber Series

- Individual hard, clear crescent cubes free of impurities, resulting in crystal clear cubes
- Durable stainless steel exterior
- Protected by HoshiGuard Antimicrobial Agent
- CycleSaver design: fewer cycles result in less wear and tear on the equipment
- EverCheck alert system—tells you when your unit needs service
- Energy Star

Flaker Series

- Water is squeezed from the ice producing hard, dry flakes resulting in quicker cooling for molding purposes
- Durable stainless exterior
- Protected by HoshiGuard Antimicrobial Agent
- CycleSaver design: fewer cycles result in less wear and tear on the equipment
- Clean cycle: rinses every 12-hours to wash away impurities and minerals, producing cleaner ice
- Removable, cleanable air filters

Cube Ice		Production	Storage	Dimensions	Weight	Item #	Price
	A.	165 lbs.	80 lbs.	24"W x 28"D x 39"H	165 lbs.	*35059	\$4,554.99
	B.	273 lbs.	260 lbs.	22"W x 27 ³ / ₈ "D x 30 ¹³ / ₁₆ "H	320 lbs.	*35060	\$7,389.99
Flake Ice		Production	Storage	Dimensions	Weight	Item #	Price
	C.	330 lbs.	80 lbs.	24"W x 26"D x 39"H	178 lbs.	*35061	\$6,984.99
	D.	493 lbs.	260 lbs.	22"W x 27 ³ / ₈ "D x 27 ⁷ / ₈ "H	310 lbs.	*35062	\$8,894.99



Ice Scoops

Aluminum

38 oz.	90083	\$26.99 ea.
84 oz.	90515	\$40.99 ea.
Plastic	90039	\$13.99 ea.

* Direct-ship item. Please allow additional time to receive.

FREE SHIPPING at SchoolHealth.com/SportsMed

Get FREE SHIPPING on your online order over \$100! Go to the back cover for Free Ship Online code. Can only be used once per customer. Expires 12-31-20.

Whirlpools



Whitehall E-15 Mobile Extremity Whirlpool

This "E-Series" mobile whirlpool combines the ease of heavy-duty, front-locking swivel casters with the durability of heavy-gauge stainless steel construction. A 1/2 HP turbine functions as an agitator and emptying device. Also features a dual scale thermometer.

Capacity: 15 Gallons
 Shipping Weight: 100 lbs.
 Dimensions: 25"L x 13"W x 15"D

.....*39020 \$4,844.99 ea.



Whitehall SB-100-M Slant Back Mobile Whirlpool

This mobile unit from Whitehall facilitates the treatment of the extremities, hips, back, and shoulder areas, plus it is wide enough to accommodate larger patients.

Capacity: 100 Gallons
 Dimensions: 25"L x 14"W x 16"H

.....*39028 \$15,224.99 ea.



Whitehall S-110 Mobile Whirlpool

Whirlpool tank has an extended stainless steel skirt that is flush to the floor line to conceal internal drain piping.

Capacity: 110 Gallons
 Shipping Weight: Mobile 230 lbs., Stationary 250 lbs.
 Dimensions: 56"L x 24"W x 25"D

S-110 Mobile.....*39002 \$7,314.99 ea.
 S-110 Stationary.....*39003 \$8,164.99 ea.



Whitehall S-90 Mobile Whirlpool

Whirlpool tank is fitted with an auxiliary drain valve.

Capacity: 90 Gallons
 Shipping Weight: Mobile 200 lbs., Stationary 220 lbs.
 Dimensions: 46"L x 24"W x 25"D

S-90 Mobile.....*39000 \$7,139.99 ea.
 S-90 Stationary.....*39001 \$7,034.99 ea.

Go to page 217 to find Cool Down Tubs

* Direct-ship item. Please allow additional time to receive.

Whirlpool Tables & Accessories



A



B



C



D



E

A. Tank Top Seat

This 12" wide seat wraps around a tank, supported by brackets gripping the rim. Up to 280 lbs.

For 20" Wide Whirlpool	*39027	\$1,474.99 ea.
For 24" Wide Whirlpool	*39026	\$1,887.99 ea.

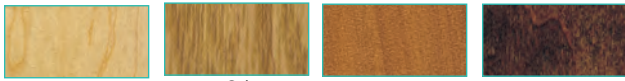

Natural Oak Cherry Walnut

Please Note: Colors are applied to a wood veneer and will differ slightly in appearance from a laminate of the same color.

B. Whirlpool Table

- Natural finish hardwood and plywood table with Natural Oak HPL top and steps
- Water-resistant finish
- Leg levelers
- 47"W x 32"D available for 22", 24" and 26" whirlpools
- Please specify manufacturer, model number, and size and height of tank when ordering. Custom sizes available. We add approximately 1¼" to the width of the tank as a clearance factor.

Weight capacity: 300 lbs.

47"L x 32"W x Variable Height (Footprint w/steps 56"L x 42"W)		
22"	*24634	\$1,199.99 ea.
24"	*24635	\$1,199.99 ea.
26"	*24636	\$1,199.99 ea.
32"	*24633	\$1,199.99 ea.

WHIRLPOOL CLEANERS

HydroChlor Water Dissolvable Packets (Not Shown)

Features:

- Contains 100% Chloramine-T, proven to be an effective way to sanitize
- Chloramine-T is stable and has functions for killing the right bacteria, viruses, fungi, E-coli, MRSA, and spores
- Is available in pre-measured, water-dissolvable packets or in bottles

15 g, 48 units/box	44614	\$99.99 box
30 g, 36 units/box	44615	\$104.99 box
50 g, 24 units/box	44615	\$104.99 box
80 g, 24 units/box	44617	\$99.99 box
5 lbs., bottle	44619	\$94.99 ea.

C. School Health Brand Wood Whirlpool Table

Same quality construction as School Health Brand Treatment Tables. Solid hardwood frame is available in four finishes. Laminate top provides a nonporous surface for easy cleanup and maintenance. Each table is custom-made to fit your whirlpool. When ordering, please specify model number of whirlpool. If the model number is unknown, contact us for more info on how to measure. Specify black, white, or fog dust laminate color. Select veneer finish.

Shipping Weight: 160 lbs.

.	*24405	\$1,059.99 ea.
-----------	---------------	----------------

Athletic Edge Aluma Elite Whirlpool Tables

The whirlpool tables are built to handle the harshest environments. These tables are fabricated with a rugged aluminum frame that maintains its structure and integrity, while the whirlpool tabletop and steps are made of a durable phenolic material that holds up to wet environments.

- Durable aluminum construction
- Rugged phenolic top
- Storage shelf
- Tough powder coat finish
- 31" or 34" standard heights available
- Single or dual tub available
- Load capacity: 600 lbs.
- Graphics package includes: (2) school logo/name decals on end panel (1 on each end)

D. Single Whirlpool Tables

46"W x 38.25"D x 34"H	*1007463	\$2,159.99 ea.
46"W x 38.25"D x 31"H	*1007464	\$2,109.99 ea.

E. Dual Whirlpool Tables

80.5"W x 38.25"D x 31"H	*1007465	\$3,499.99 ea.
80.5"W x 38.25"D x 34"H	*1007462	\$3,499.99 ea.

FREE SHIPPING at SchoolHealth.com/SportsMed

Get FREE SHIPPING on your online order over \$100! Go to the back cover for Free Ship Online code. Can only be used once per customer. Expires 12-31-20.

* Direct-ship item. Please allow additional time to receive.

Stimulators & Ultrasound



Richmar Winner EVO Systems

The Winner EVO systems provide the most comprehensive therapies in one unit with a simple-to-use platform known for quality & reliability. Winner EVO CM4 can run 4 channels of electrical stimulation, ultrasound, as well as 2 channels of laser and/or light therapy and at the same time, ensuring maximum utilization and return. Each unit is made in the USA and comes with a 3 year warranty.

Stim features:

- Five waveforms: IFC, Premod, High Volt, Russian, Microcurrent
- User-defined profiles for commonly used treatments
- Lead Cord tester for on-board diagnostic testing
- Two or four channels

Ultrasound features:

- Dual frequency clinical ultrasound (1 & 3 MHz) with industry leading BNR
- Continuous or pulsed duty cycles

A. Winner EVO 4 Channel Combination Package (Rx Item)

..... *1005428 \$4,061.99 ea.
(4 channel combo, Therapy Hammer applicator, StoreMore cart, 1 case multistim electrodes)

B. Winner EVO 4 Channel Stim (Rx Item)

..... *1005422 \$2,887.00 ea.

C. Therasound EVO (Rx Item)

..... *1005429 \$1,889.99 ea.
(1 & 3 MHz ultrasound, Therapy Hammer applicator, 1 case GelShot)

Richmar Ultrasound Applicators:

D. 5 cm Ultrasound Applicator *1005432 \$353.99 ea.

E. 10 cm Ultrasound Applicator *1005433 \$382.99 ea.

F. Therapy Hammer, Applicator with 2 cm and 5 cm Transducer
..... *1005431 \$554.99 ea.

Accessories:

Evo Storemore Therasound Cradle (Needed to mount unit to cart)
..... *1005430 \$74.99 ea.

Evo Storemore Therapy Cart *1005424 \$546.99 ea.

Laser Light Application

Hands-Free Light Cluster Probe 500 mW 870 nm SLD/LED
..... *1006403 \$1,126.99 ea.

G. AutoSound Applicator

Maximizing time efficiency while ensuring positive clinical outcomes can be achieved through the utilization of the time-tested AutoSound.

- Patented, hands-free ultrasound applicator
- 1MHz, 3MHz, as well as 1 & 3MHz sweep
- Applicator includes swivel attachment with three fabriFoam Velcro® straps for easy fixation to the body
- Four individual 3.5cm² transducers in each Autosound applicator
- Sequences between each of the four 3.5cm² transducers for 1 second each
- 1 year warranty

Autosound Applicator *1005425 \$954.99 ea.

Autogel Pads for Autosound (50/Case).... *1005412 \$37.99 cs.

Laser Prism Probes

(Cordless) 200 mW, 785 nm Laser *1006401 \$2,669.99 ea.

(Tethered) 200 mW, 785 nm Laser..... *1006402 \$3,619.99 ea.

Laser Modules

Winner Evo (Required for Tethered Probe or Light Cluster)
..... *1006399 \$469.99 ea.

Rx Item—All prescription (Rx) purchases requires Rx authorization form. See "Medical Authorization Form" in the index. Call Customer Care at 866-323-5465 with any questions.

*Direct-ship item. Please allow additional time to receive.



TheraTouch LX2

The TheraTouch LX2 is a two-channel 3B Laser therapy device, capable of delivering up to 35 joules/cm² per treatment with its standard 850 nm 9 diode applicator.

Features:

- Delivers up to 35 j/cm² in a single treatment
- Programmable treatment time up to 4 minutes
- Continuous or pulsed output modes
- 2 output channels
- 10 predefined clinical protocols
- Save up to 100 user-defined protocols
- Available with therapy cart

Included applicator:

- 9 diode cluster applicator (DQLLLT-CA)
- Diode specifications 9 diode cluster laser 1040 mW
- Four 650 nm (10 mW) LED
- Five 850 nm (200 mW) laser
- Maximum power 1040mW±20%

TheraTouch LX2 Low Level Laser **1033899** \$3,639.99 ea.



TheraTouch CX4

The TheraTouch CX4 is an advanced combination electrotherapy and ultrasound system with pre-programmed clinical protocols selectable from within the menu-driven touch screen interface.

Features:

- 1 MHz and 3 MHz ultrasound frequency
- Included waveforms: interferential (4 Pole IFC), premodulated (2 Pole IFC), biphasic (TENS), neuromuscular stimulation (NMS), Russian, high volt, microcurrent, Rapid Agonist Antagonist Sequencing (RAAS)
- 4 channels of stimulation, can be linked or controlled independently
- RAAS waveform is used to replicate typical firing patterns of muscle contractions to reeducate muscles and restore functional movement
- Anatomical libraries with recommended electrode placement
- Stores up to 99 user-defined protocols for future use
- Three year warranty

TheraTouch CX4 Electrotherapy System . . . **1033897** \$2,599.99 ea.

TheraTouch CX4 Electrotherapy System with Therapy Cart **1033898** \$3,429.99 ea.

*Direct-ship item. Please allow additional time to receive.

Stimulators & Ultrasound



Chattanooga Intellect® Legend XT

Features include:

- Clean, award winning modular design
- Multiple waveform electrotherapy—six clinical waveforms: interferential, premodulated, high volt, Russian, symmetrical byphasic, and microcurrent
- Independent electrotherapy channels
- User-defined protocols for your specific needs
- Documentation with Patient Data Cards, including pain map profile, modality records, electrode placement diagrams, and session notes

Systems include:

- Patient Data Card
- Leadwire Channels 1–4
- 4 DURA-STICK II 2.75" (7 cm) Electrodes
- 5 cm² sound head applicator
- Combination system comes with an 8.5 oz. bottle of conductor ultrasound, a 5cm² sound head applicator and leadwire channels 1 & 2

Electrotherapy 4-Channel with Cart (Rx Item)	*90759	\$5,014.99 ea.
Electrotherapy 4-Channel Combination with Cart (Rx Item)	*90760	\$6,089.99 ea.
Electrotherapy 4-Channel (Rx Item)	*90761	\$3,579.99 ea.
Electrotherapy 4-Channel Combination (Rx Item)	*90762	\$5,149.99 ea.
Therapy Cart	*90763	\$554.99 ea.
Patient Data Cards, 25/pkg.	*90768	\$134.99 pkg.
2 cm ² Applicator	*90764	\$384.99 ea.
5 cm ² Applicator	*90765	\$384.99 ea.
10 cm ² Applicator	*90766	\$384.99 ea.

Rx Item—All prescription (Rx) purchases requires Rx authorization form. See "Medical Authorization Form" in the index. Call Customer Care at 866-323-5465 with any questions.

Chattanooga Intellect® Transport Electrotherapy

Lightweight design, along with battery-powered option and custom designed mobile carrying bag, making transport easy.

- 2 channels of electrical stimulation output
- 10 user-defined memory positions for user protocols
- 110V or battery-powered option
- Independent intensity and parameter controls for each channel
- 4 standard waveforms on board: interferential, premod, Russian and high volt
- Logical control system and a large, easy-to-read graphical LCD display
- Unit uniquely designed for tabletop, wall mount, or mobile use

12.8" x 11.3" x 6.4", 5.07 lbs.	*90883	\$2,507.99 ea.
Carrying Case	*90885	\$196.99 ea.
Battery Pack	*90886	\$409.99 ea.

Chattanooga Intellect® Transport Ultrasound

Provides an innovative case design, with a logical control system and a large, easy-to-read graphical LCD display.

- Fully functional 1 and 3.3 MHz frequencies
- 10 new user-defined memory positions for user protocols
- Pulsed and continuous therapy operation (10%, 20%, 50%, and 100%)
- Beam Nonuniformity Ratio (BNR) 5:1 maximum
- 110V or battery powered option
- New, ergonomically designed ultrasound applicators in variety of sizes (1 cm², 2 cm², 5 cm² and 10 cm²)
- Applicators are interchangeable with Electronic Signature[®] residing on all transducers
- Head warming function on all applicators

12.9" x 11.3" x 6.4", 5.07 lbs.	*90884	\$2,148.99 ea.
Carrying Case	*90885	\$196.99 ea.
Battery Pack	*90886	\$409.99 ea.

Chattanooga Vectra Genisys Therapy Systems

Vectra Genisys is the first modular therapy system that consolidates up to six therapeutic modalities in one system, at a fraction of what these modalities would cost alone. Unique modular design lets you choose what fits best in your clinical setting now, or easily add to later without the replacement of products.

Electrotherapy features:

- Clinical protocols and indications for acute pain chronic pain
- Four waveforms (IFC, premod, Russian, micro-Current)
- User-defined protocols resource library patient documentation
- Two or four channels with or without sEMG

Ultrasound features:

- Clinical protocols and indications for relief of pain and joint contractures
- Four convenient sizes of sound heads with head warming feature Electronic Signature™ on all sound head applicators for easy interchangeability

Laser features:

- Eight interchangeable laser applicators in a wide range of strengths and sizes to meet any treatment need
- Electronic Signature™ on all applicators
- Choice of eight interchangeable laser diode and cluster applicators with wavelengths ranging from 670 nm–950 nm and output power ranging from 100 mW–1440 mW (dependent upon applicator)
- Laser protective eyewear included (2x)

Leadwires

Electrotherapy Leadwire—Channel 1	1006189	\$28.99 ea.
Electrotherapy Leadwire—Channel 2	1006190	\$29.99 ea.
Electrotherapy Leadwire—Channel 3	1006191	\$32.99 ea.
Electrotherapy Leadwire—Channel 4	1006192	\$29.99 ea.
sEMG Lead Wire Channel 1 (Pair)	1006193	\$39.99 ea.
sEMG Lead Wire Channel 2 (Pair)	1006194	\$39.99 ea.

Vectra Genisys Accessories

Patient Data Cards (25/Pk.)	90768	\$134.99 ea.
sEMG Data Card (Each)	1006188	\$11.99 ea.
Battery Module	1006202	\$694.99 ea.
Laser Module.	1033834	\$1,244.99 ea.
Therapy Cart.	91284	\$454.99 ea.
Operator Remote—Channels 1 & 2	1006199	\$138.99 ea.
Operator Remote—Channel 3 & 4	1006187	\$138.99 ea.



Laser Applicators*

(*Applicators can be used with the Laser Therapy System #91226 or as an add-on for the 2 Channel Vectra Genisys Systems with a Laser Module Adaptor.)

Laser Applicator Single Diode (Rx Item)

100 mW Total	*91228	\$1,159.99 ea.
200 mW Total	*91229	\$1,424.99 ea.
300 mW Total	*91230	\$2,097.99 ea.

Laser Applicator 9 Diode Cluster (Rx Item)

540 mW Total	*91231	\$2,757.99 ea.
1040 mW Total	*91232	\$3,765.99 ea.

Laser Applicator 13 Diode Cluster (Rx Item)

415 mW Total	*91233	\$2,687.99 ea.
------------------------	---------------	----------------

Laser Applicator 13 Diode Cluster (Rx Item)

715 mW Total	*91234	\$2,626.99 ea.
------------------------	---------------	----------------

Laser Applicator 33 Diode Cluster (Rx Item)

1440 mW Total	*91235	\$3,104.99 ea.
-------------------------	---------------	----------------



Electrotherapy System

Vectra Genisys 2 Channel Electrotherapy System	*1006209	\$3,314.99 ea.
Vectra Genisys 4 Channel Electrotherapy System	*1006211	\$4,179.99 ea.

Combination System

Vectra Genisys 2 Channel Combination System	*1006210	\$4,739.99 ea.
Vectra Genisys 2 Channel Combination System with Cart	*1006213	\$5,244.99 ea.
Vectra Genisys 4 Channel Combination System	*1006212	\$5,354.99 ea.
Vectra Genisys 4 Channel Combination System with Cart	*1006214	\$5,234.99 ea.

Rx Item—All prescription (Rx) purchases requires Rx authorization form. See "Medical Authorization Form" in the index. Call Customer Care at 866-323-5465 with any questions.

*Direct-ship item. Please allow additional time to receive.

FREE SHIPPING at SchoolHealth.com/SportsMed

Get FREE SHIPPING on your online order over \$100! Go to the back cover for Free Ship Online code. Can only be used once per customer. Expires 12-31-20.

Deep Oscillation Therapy



A



B



C

A. HIVAMAT 200 Evident

Your athletes will most certainly benefit from the reduction of inflammation, pain relief, and increased circulation that results from deep oscillation therapy with the HIVAMAT 200 Evident. Deep oscillation therapy is a new therapeutic treatment that directly addresses contusions, edema, hematomas, and other effects of trauma often associated with sports injuries by activating the lymphatic system.

Muscle Relaxation—Deep oscillation therapy is felt as a vibration within the tissue, relaxing the underlying muscles.

Pain Relief—Activating the lymphatic system and increasing blood flow, pressure upon the nerves is reduced; with the pain subsided, mobility can be reintroduced earlier.

Features:

- Two sets of ports allowing for two treatments to be performed at the same time
- Full-color display with simple-to-use interface
- Pre-populated treatment programs
- Area-specific instructional application animations
- User-controlled parameters
- Save treatment programs to device or card
- 3 year warranty

Hivamat 200 Evident.....	*1007416	\$11,339.99 ea.
Hivamat Evident Trolley	*1007414	\$1,819.99 ea.

B. HIVAMAT 200 Portable

Hivamat 200 Portable is a battery-powered deep oscillation therapy device with selectable protocols to treat common conditions.

- Simple-to-use interface
- Battery operated
- 3 year warranty
- Practice-specific treatment protocol cards for:
 - » Rehabilitation
 - » Athletic training
 - » Chiropractic

HIVAMAT 200 Portable	1007415	\$6,199.99 ea.
Self-Treatment Applicator Kit	1030425	\$379.99 ea.
Snap Electrodes 2/Pk., 50/Case.....	1030424	\$184.99 ea.

C. TheraTouch DX2 Shortwave Diathermy

TheraTouch DX2 introduces several new advancements in safety, convenience, and efficiency compared to other shortwave diathermy devices.

Features:

- Dose I—Subthermal
- Dose II—Mild Heat
- Dose III—Low Heat
- Dose III SDC M—Moderate Heat
- Dose III SDC H—High Heat

- Dose IV—Vigorous Heat High Efficiency Auto-Tuning (H.E.A.T.)
- Resonant auto-tuning technology continually measures and adjusts to changes in the patient's impedance to provide maximum energy transmission, resulting in faster heating and shorter treatment times

Benefits:

- Nine evidence-based quick Links by indication
- Qualitative thermal dosimetry with six settings included
- Easy to use, touch-screen interface
- USB port for easy software upgrades
- Dual treatment indicators on unit and inductive drum
- 3 year warranty

.....	1030924	\$8,054.99 ea.
-------	----------------	----------------

FREE SHIPPING at SchoolHealth.com/SportsMed

Get FREE SHIPPING on your online order over \$100! Go to the back cover for Free Ship Online code. Can only be used once per customer. Expires 12-31-20.

*Direct-ship item. Please allow additional time to receive.



MicroBlock Antimicrobial Electrodes

MicroBlock antimicrobial electrodes are the first and only electrodes on the market that help kill and inhibit the growth of common bacteria on and around the zone of inhibition of the electrode surface. These electrodes can play an important part in infection prevention for hospitals and healthcare facilities, making MicroBlock the logical choice to decrease the risk of healthcare-associated infections while treating your patients. MicroBlock's antimicrobial electrode surface reduces the risk of contamination and helps prevent infection by killing disease-causing microbes and common antibiotic-resistant threats that contact the surface of the electrode, such as:

- E. cloacae (CRE)
- S. aureus (MRSA)
- E. coli (ESBL)
- E. faecalis (VRE)
- P. aeruginosa and A. baumannii (Multi-Drug Resistant)

2" Round White Cloth.....	1033886	\$3.49 ea.
2" x 2" Square White Cloth.....	1033887	\$3.49 ea.
2" x 3.5" Rectangle White Cloth.....	1033888	\$6.49 ea.
3" Round White Cloth.....	1033889	\$6.49 ea.
3" x 5" White Cloth.....	1033885	\$6.49 ea.

Richmar MultiStim Electrodes

MultiStim Electrodes are constructed of a premium hydrogel for comfort and uniform stimulation. All of Richmar's stim electrodes are manufactured to have high tensile-strength lead wires. Uses a proprietary bonding and moisture barrier to protect against delamination when used in conjunction with moist heat therapy.

Features:

- MultiStim Electrodes are available in cloth or foam, in a variety of shapes and sizes
- Economical stim electrodes that do not sacrifice adhesion or performance
- Gel formulation produces electrodes with maximum dry-out resistance
- Optimum distribution of electrical current throughout electrode surface
- All Richmar electrodes are made in the USA

Sold in cases of Ten 4-packs/40 electrodes.

2" Round Cloth Electrode.....	1005413	\$33.99 cs.
2" Round Foam Electrode.....	1005414	\$34.99 cs.
2"x 2" Square Cloth Electrode.....	1005415	\$33.99 cs.
2" x 2" Square Foam Electrode.....	1005416	\$33.99 cs.
2" x 3.5" Rectangle Cloth Electrode.....	1005417	\$51.99 cs.
2" X 3.5" Rectangle Foam Electrode.....	1005418	\$51.99 cs.
3" Round Cloth Electrode.....	1005419	\$46.99 cs.
3" Round Foam Electrode.....	1005420	\$46.99 cs.

Premium Silver Electrodes

- Premium electrodes feature silver (Ag) coated carbon film for reduced impedance, greater conductivity, and uniform current dispersion
- Extra-long, 6", pure copper strand lead wires with dispersive heads help to prevent wire pull-out from body of electrode
- Extra-strong, self-adhering conductive hydrogel provides soothing comfort and maximum re-usability
- Made in America

2" Round, 4/pkg.....	91183	\$5.99 pkg.
2" x 2" Square, 4/pkg.....	91185	\$5.99 pkg.
1.75" x 3.75" Rectangle, 4/pkg.....	91186	\$11.99 pkg.

Pro-Sport Stim Electrodes

- Long-lasting, self-adhering, conductive hydrogel provides soothing comfort and maximum reusability
- Pure copper strand lead wires provide the lowest impedance for maximum treatment results
- Made in America

2" Round, 4/pkg.....	91187	\$4.99 pkg.
2" x 2" Square, 4/pkg.....	91188	\$4.99 pkg.
1.75" x 3.75" Rectangle, 4/pkg.....	91189	\$10.99 pkg.

Chronicare™ TENS Electrodes

Carbon film and lead wire technology ensures optimum current distribution. Soft cloth backing maximizes conformity. Non-irritating. Spring-loaded connector to fit any size pin.

2" Round, 4/pkg.....	90525	\$10.99 pkg.
2" Square, 4/pkg.....	90524	\$10.99 pkg.
2" x 3½" Rectangle, 4/pkg.....	90523	\$13.99 pkg.

Dura-Stick Supreme Electrodes

Available in packages of four or boxes of ten packages.

2" x 2" Square, 40/box.....	90266	\$158.99 box
2" x 2" Square, 4/pkg.....	90322	\$18.99 pkg.

Dura-Stick II Electrodes

2" x 2" Square, 40/box.....	90264	\$62.99 box
2" x 2" Square, 4/pkg.....	90320	\$5.49 pkg.
2" Round, 40/box.....	90265	\$62.99 box
2" Round, 4/pkg.....	90321	\$5.49 pkg.

Not made with Natural Rubber Latex.

Stimulators & Ultrasound Accessories

IONTOPHORESIS



A. Iomed Companion 80

Designed to deliver an 80 mA-minute dose over 24 hours. Reserve battery capacity compensates for patients with higher skin resistance. Hypoallergenic Adhesive works even in the shower. High tech design conforms well to treatment areas and fits comfortably beneath clothing. Hypoallergenic and not made with natural rubber latex to stay flexible and breathable.

6/box.....90809 \$57.99 box

B. IontoPatch Electronic Transdermal Drug Delivery System

Delivers dosage of 80 mA-minutes in 24 hours without irritating the skin. Ultra-thin battery technology provides iontophoresis with no external batteries or wires! Provides greater time-released dose than traditional drug delivery systems. Clinician applies medication to patch. Individually packaged patch includes alcohol prep wipe and extra adhesive dots.

IontoPatch Regular, 6/pkg.....90437 \$71.99 pkg.

IontoPatch SP, 6/pkg.....90490 \$71.99 pkg.

logel Electrodes

Elliptical shape follows the line of the tendon. Clear adhesive allows precise placement on target site. Color-coded for easy identification.

Small, 12/box90743 \$152.99 box

Medium, 12/box.....90744 \$155.99 box

Large, 12/box90745 \$159.99 box

TransQ Electrodes

Designed for treating a variety of sites. Adhesive foam stretches and adheres well under stress.

Small, 12/box90746 \$169.99 box

Medium, 12/box.....90747 \$169.99 box

ULTRASOUND GEL



Signa Spray Electrode Solution and Skin Prep

Highly conductive, multi-purpose spray electrolyte and non-gritty skin prep. No residue build-up. Easy to apply and clean up.

8.5 oz. Spray50086 \$11.9 ea.

Aquasonic Transmission Gel

1 Liter Bottle34003 \$13.99 ea.

5 Liter with Dispenser.....34002 \$36.99 ea.

1 Liter with Dispenser, Clear34174 \$14.99 ea.

5 Liter Bottle, Clear34175 \$35.99 ea.

Polysonic Transmission Lotion

8.5 oz. Bottle.....34084 \$5.99 ea.

Gallon34086 \$35.99 ea.

InTENSity



A. InTENSity™ Select Combo

The InTENSity™ Select Combo is a powerful, easy-to-use portable device. Complete with four waveforms, the unit gives you and your patients the flexibility to treat a variety of musculoskeletal issues. With a strong current of 105 mA, this innovative device combines TENS, EMS, Interferential and Microcurrent and comes complete with an AC adaptor, ensuring you always have power to the device when traveling. One year warranty.

Includes:

- Carrying case
- Two sets of lead wires
- 9-volt battery
- AC adaptor
- Manual
- Pack of four self-adhesive reusable electrodes

.....91614 \$208.99 pkg.

Not made with Natural Rubber Latex.

B. InTENSity Select Combo II

The InTENSity IF Combo II is the newest standard in portable, multi-function electrotherapy offering patients two modalities in one user-friendly, ergonomic design—Transcutaneous Electrical Nerve Stimulation (TENS) and Interferential Stimulation (IF).

The wide-ranging capability of the InTENSity IF Combo II provides the most up-to-date treatment technology and waveforms. This powerful device delivers up to 10,000 Hz of IF therapy with sweep frequency capabilities to prevent accommodation while providing maximum treatment benefits. Simply choose a preset program by body part or customize a program to meet your specific therapy needs.

..... 1033894 \$123.99 ea.

C. InTENSity Twin Stim IV

The InTENSity Twin Stim IV is the newest standard in portable, multifunction electrotherapy offering patients two modalities in one user-friendly, ergonomic design—Transcutaneous Electrical Nerve Stimulation (TENS) and Neuromuscular Electrical Stimulation (NMES).

Equipped with pre-set body part specific settings, as well as a customizable option, the InTENSity Twin Stim IV intuitively guides the patient step-by-step to ensure the ideal therapeutic treatment throughout the healing cycle.

..... 1033893 \$71.99 ea.

Blood Flow Restriction & Stimulators



COMPEX® Electric Muscle Stimulators

Use Compex to help speed your athlete's recovery time. Compex's electric muscle stimulation (EMS) technology sends electronic pulses to your motor nerves in order to create muscle contractions. Compex units also include TENS capability. Each Compex package comes with four small and two large electrodes, and a 2 year warranty.

Edge	1031040	\$184.99 ea.
Performance	1031039	\$299.99 ea.
Sport Elite	1031038	\$349.99 ea.
Wireless USA	1031041	\$829.99 ea.



NEW!

COMPEX® Mini Wireless

Wireless, mobile, smart-stim device. The Compex Mini Wireless can take your training to the next level in the palm of your hand. Connecting to your smartphone, the Compex Mini Wireless FDA-510(k) cleared electric muscle stim device and TENS machine is designed to help you tackle your warm-up, training, recovery, and pain management—whether on the go, in the gym, or at home.

.	1035358	\$249.99 ea.
-----------	----------------	--------------



Smart Cuffs

Smart Cuffs help your athlete accelerate and enhance their rehabilitation protocol through blood flow restriction training.

Benefits include:

- Increased muscle size and strength
- Increased cardiovascular capacity
- Increased GH, IGF1
- Decreased joint/tissue stress
- Low intensity needed

Basic Set (Includes 2 Cuffs, 1 Gauge)	1030937	\$374.99 set
Personal Set (Includes 4 Cuffs, 1 Gauge)	1030939	\$639.99 set
Clinical Set (Includes 10 Cuffs, 1 Gauge, 1 Doppler)	1030938	\$1,589.99 set

Accessories

Doppler	1031211	\$186.99 ea.
Gauge	1031212	\$182.99 ea.



Marc Pro Products

Marc Pro is intended for muscle conditioning by stimulating muscle in order to improve or facilitate muscle performance.

Marc Pro Plus has all the features and benefits of the Marc Pro with additional modes for pain relief. The Marc Pro Plus is used for temporary relief of pain associated with sore muscles due to strain from exercise.

Devices

Marc Pro Device	1007935	\$744.99 ea.
Marc Pro Plus Device	1007936	\$1,484.99 ea.

Accessories

Reusable Electrodes Single Package 4/Package	1007989	\$14.99 pkg.
Reusable Sensitive Skin Electrodes 4/Package	1007981	\$18.99 pkg.
Commercial Grade Wire (Black)	1007985	\$18.99 ea.
Commercial Grade Wire (Gray)	1007986	\$18.99 ea.
Replacement Battery	1007982	\$45.99 ea.
Replacement Battery Charger	1007983	\$16.99 ea.
Marc Pro Replacement Case	1007988	\$39.99 ea.
Marc Pro Plus Replacement Case	1007990	\$45.99 ea.
Europlug Adapter	1007987	\$2.49 ea.
Belt Clip	1007984	\$7.99 ea.
Aloe Gel, 2 oz.	1007980	\$7.99 ea.

Cold/Hot Systems



GAME READY®

Game Ready® Control Unit & Accessories

Game Ready's active compression squeezes greater benefits out of cold therapy alone. Circumferential wraps envelope the injury or surgery site and pneumatic compression works to conform the wrap to the contours of the body, allowing for better surface contact and more effective cooling.

Control Unit	37233	\$2,754.99 ea.
Game Ready Carry Bag	37237	\$199.99 ea.
Single Connector Hose, 6 ft.	37238	\$186.99 ea.
Dual Connector Hose	37246	\$437.99 ea.
O-ring Kit: (9) O-Rings, Silicone Spray.	1006786	\$27.99 kit
Replacement O-Rings, 9/pkg.	1006813	\$10.99 pkg.
Silicone Spray	1006814	\$11.49 ea.
AC Adapter	37445	\$57.99 ea.
Game Ready Med4elite Control Unit	1008579	\$18,559.99 ea.



Power Cord	1008573	\$37.99 ea.
Travel Case	1008574	\$2,389.99 ea.
USB Flash Drive Kit	1008575	\$19.99 kit
Drain Hose Kit	1008576	\$24.99 kit
Air Filter	1008577	\$9.99 ea.



A. Game Ready® Full Leg Boot

Medium	1030977	\$745.99 ea.
Large	1030976	\$739.99 ea.
Extra Large	1030975	\$752.99 ea.

Full Leg Boot Sleeves

Medium	1030974	\$189.99 ea.
Large	1030973	\$188.99 ea.
Extra Large	1030972	\$189.99 ea.

B. Game Ready® Knee Wrap

One Size Fits All	37236	\$419.99 ea.
-----------------------------	--------------	--------------

C. Game Ready® Flexed Elbow Wrap

One Size Fits All	37317	\$489.99 ea.
-----------------------------	--------------	--------------

D. C-T Spine Wrap

One Size Fits All	1002868	\$548.99 ea.
-----------------------------	----------------	--------------

E. Game Ready® Hip/Groin Wrap

Universal, fits a wide range of body types		
Right	37248	\$484.99 ea.
Left	37249	\$484.99 ea.

F. Game Ready® Ankle Wrap

Large, fits men's shoe sizes 6 to 11, women's up to size 13		
.	37234	\$409.99 ea.
X-Large, fits men's shoe sizes 12 to 18	37235	\$409.99 ea.

G. Game Ready® Cooling Vest

Easy on/off center chest zipper and side straps for customizable fit.
Cooling Vest Wrap **1007552** \$559.99 ea.

H. Game Ready® Half Leg Boot Wrap

One Size Fits All	37316	\$489.99 ea.
-----------------------------	--------------	--------------

I. Game Ready® Back Wrap

Fits waist sizes 22" to 55"	37244	\$489.99 ea.
---------------------------------------	--------------	--------------

J. Game Ready® Elbow Wrap

One Size Fits All	37239	\$355.99 ea.
-----------------------------	--------------	--------------

K. Game Ready® Shoulder Wrap

Medium, fits chest sizes 33" to 45"		
Right	37243	\$486.99 ea.
Left	37242	\$486.99 ea.
Large, fits chest sizes 40" to 55"		
Right	37241	\$485.99 ea.
Left	37240	\$485.99 ea.

L. Game Ready® Hand/Wrist Wrap

Universal, any size, either hand.	37136	\$434.99 ea.
-------------------------------------------	--------------	--------------

REPLACEMENT SLEEVES AND MORE ATTACHMENTS AVAILABLE ONLINE!

MED4 ELITE®

FOUR THERAPIES
IN ONE RECOVERY SYSTEM

 ICELESS COLD

 RAPID CONTRAST

 CONTROLLABLE HEAT

 COMPRESSION ONLY



GRPRO® 2.1

INTEGRATED ACTIVE COLD
AND COMPRESSION SYSTEM

 ACTIVE COLD

 COMPRESSION



*Cryo Cap, C-T Spine, Cooling Vest, and Traumatic Amputee Wraps are for use with the GRPro 2.1 Only

GAME READY®

HUMAN INSPIRED. TECHNOLOGY DRIVEN.™

GAME CHANGING RECOVERY

The NormaTec PULSE 2.0
Series brings rehab and
recovery to your fingertips.





- World voltage 12 V power and rechargeable li-ion battery
- Compact, lightweight design (3.6 lb. device)
- Customizable time, pressure, and zone settings
- Zone Boost feature
- Reinforced, durable construction
- Two-year warranty on all components



NormaTec PULSE 2.0 Standard Packages

(Also available in tall and short sizes online.)

The NormaTec PULSE 2.0 brings you cutting-edge connectivity and powerful results in a compact, modern system that travels well and is built to last. Package includes device, hosing, power supply, and attachments.

Full Body (Two Leg, Two Arm, & One Hip)	1034224	\$2,319.99 pkg.
Leg & Arm (Two Leg & Two Arm)	1034218	\$1,904.99 pkg.
Lower Body (Two Leg & One Hip)	1034212	\$1,709.99 pkg.
Upper Body (Two Arm)	1034211	\$1,314.99 pkg.
Leg (Two Leg)	1034205	\$1,302.99 pkg.

NormaTec PULSE PRO 2.0 Standard Packages

(Also available in tall and short sizes online.)

All the great advantages of the PULSE 2.0, plus a sophisticated touchscreen display and highly customizable programming options. Package includes device, hosing, power supply, custom designed premium hard carry case, and attachments.

Full Body (Two Leg, Two Arm, & One Hip)	1034249	\$3,499.99 pkg.
Leg & Arm (Two Leg & Two Arm)	1034243	\$3,124.99 pkg.
Lower Body (Two Leg & One Hip)	1034237	\$2,909.99 pkg.
Upper Body (Two Arm)	1034236	\$2,514.99 pkg.
Leg (Two Leg)	1034230	\$2,514.99 pkg.

OTHER PULSE 2.0 RECOVERY PACKAGES AND ATTACHMENTS AVAILABLE ONLINE!



Both versions feature a Bluetooth enabled app, allowing you to integrate your recovery session seamlessly into your training plan and control your session directly from your phone.

- Customize time and pressure settings
- Activate Zone Boost
- Save and restore favorite settings
- Track and share your recovery stats
- Upload recovery data to your other training and tracking apps

Recovery Furniture



The Athletic Edge® Treatment and Recovery Cabinet

The Athletic Edge Treatment and Recovery Cabinet is custom designed with high quality and superior craftsmanship to minimize setup time, storage, and clutter when using the NormaTec Recovery System.

Designed with:

- Dual extension drawer fits NormaTec accessories
- Dual extension boot rack accommodates two pairs of NormaTec boots
- 57° lift back with manual gas-shock
- Individual leg elevation

Options:

- Custom graphics available on slip cover or deboss lift back cushion
- Custom graphics available on table above pull out drawer
- Solid wood options: natural wood or black finish
- Laminate options: oak, maple, or black
- All standard Athletic Edge upholstery choices

85"L x 30"W x 32"H, Weight capacity: 600 lbs.

Laminate.....	1006864	\$3,069.99 ea.
Solid Wood	1006865	\$3,249.99 ea.

Proteam® Game Ready Recovery Treatment Table

The Proteam Game Ready Recovery Table is a great solution when you have limited space by offering storage for up to two units and all components.

Proteam Treatment table is designed with:

- Front slide out storage drawer with grommet holes for easy cord management
- Side drawer with four rods to hang Game Ready wraps
- Under-the-head cabinet to store accessories
- Leg rest providing up to 75° elevation

Option Choices:

Laminate—	Upholstery—	Left handed
Natural Oak or	10 Pro-Form™	table option
Wild Cherry	vinyl colors	

78"L x 30"W x 31"H, Weight capacity: 400 lbs.

.....	1006815	\$2,554.99 ea.
-------	----------------	----------------

NormaTec® Zero Gravity Chair

Sturdy and comfortable, zero-gravity chair by NormaTec. The easy-to-fold frame and adjustable headrest add to the convenience for any recovery room. Featuring a durable steel frame and breathable mesh fabric in black color.

Features:

- Black fabric
- Black frame finish
- Sturdy steel frame
- Curved armrests
- Adjustable headrest
- Easy to fold
- Outdoor mesh fabric
- Capacity of 300 lbs.

.....	1007034	\$129.99 ea.
-------	----------------	--------------

FREE SHIPPING at SchoolHealth.com/SportsMed
 Get FREE SHIPPING on your online order over \$100! Go to the back cover for Free Ship Online code. Can only be used once per customer. Expires 12-31-20.

Rehabilitation & Exercise



Theragun 128

Massage Tools	128, 133
Massage Lotions & Creams	129
Soft Tissue Massage Tools	130-131
Hand Rollers & Massage Balls	132
Foam & Hardcore Rollers	134
Exercise Balls	135

Stretching	136-137
Balance	138-141
Exercise Bands	142-145
Medicine Balls/Rebounders	146-147
Exercise Machines	148-149

Massage Tools



A



C

Theragun G3PRO

Featuring a complete design overhaul, the G3PRO was designed to change the way you move.

Benefits:

- 2400 RPMs for pain relief
- 60 lbs. of pressure to release knots
- Promotes overall range of motion and improves muscle coordination to prevent injury
- Relieves sore, stiff muscles through amplitude, frequency, and torque
- Total body recovery in 15 minutes
- Reach 90% of the body with the rotating arm and ergonomic grip
- Accelerate warmup and recovery and decrease post-workout soreness in minutes
- 75 minutes per battery (two batteries included for continuous battery life)

Accessories included with G3PRO package:

- Travel Case
- Attachment Pouch
- Power Adapter
- These attachments:



D

Dampener
Tender areas or near bones



E

Cone
Pinpoint muscle treatment



F

Standard Ball
Overall use



G

Wedge
Scraping, shoulder blades, or IT bands



H

Large Ball
Larger muscles



I

Thumb
Trigger point therapy

A. Theragun G3PRO Package	1031637	\$599.00 pkg.
B. One Battery & Battery Charger.....	1033503	\$59.00 ea.
C. Charging Stand	1033504	\$80.99 ea.
D. Dampener.....	1033498	\$20.00 ea.
E. Cone.....	1033497	\$20.99 ea.

F. Standard Ball.....	1033500	\$20.99 ea.
G. Wedge.....	1033502	\$20.99 ea.
H. Large Ball	1033499	\$20.00 ea.
I. Thumb.....	1033501	\$20.99 ea.

NEW!

Theragun G3 Package

The Theragun G3 offers essential treatment and streamlined design. Theragun G3 is your essential companion for complete, whole-body healing, recovery, and deep muscle treatment. Use it to:

- Release tightness, knots, & spasms
- Speed up muscle activation & recovery
- Get instant, natural pain relief

Accessories included with G3 package:

- Travel Case
- Power Adapter
- Dampener Attachment
- Standard Attachment
- Thumb Attachment
- Cone Attachment

Black	1034313	\$399.00 pkg.
White	1035137	\$399.00 pkg.



[pH]UEL™

[pH]UEL can be used to release muscle tightness, increase range of motion, reduce sensitivity and discomfort associated with muscle spasms. The non-systemic, non-centrally acting, high benefit and low-risk formulation is a healthy choice for athletes and patients.

Indicated for:

- Pre/Post workout & exercise
- Pre-treatment
- Cupping therapy
- Ultrasound
- At home use and daily activity
- Electrical stimulation
- Dry needle therapy
- Tooled friction massage



8 oz. Spray	1031149	\$17.15 ea.	8 oz. Foam, 12/pkg.....	1031121	\$205.79 pkg.
8 oz. Spray, 12/pkg.....	1031120	\$205.79 pkg.	4 oz. Foam	1031148	\$8.58 ea.
8 oz. Foam	1031150	\$17.15 ea.	4 oz. Foam, 12/pkg.....	1031119	\$102.99 pkg.

NUT FREE!



Bon Vital Complete™

Bon Vital Complete Massage Creme is a premium, hypoallergenic, dual purpose creme that flawlessly combines the features of an oil and lotion, making it extremely versatile and ideal for techniques and modalities ranging from high glide to deep tissue. Formulated with a unique blend of ingredients to restore, moisturize, and soothe skin and sore muscles for the ultimate therapeutic, relaxing full body massage that benefits both the therapist and the client.

.25 Trial Size	1030415	\$1.49 ea.
3 oz. Tube	1030416	\$8.99 ea.
8 oz. Tube	1030417	\$16.99 ea.
14 oz. Jar	1030418	\$19.99 ea.
½ Gal.	1030419	\$45.99 ea.
1 Gal.....	1030420	\$70.99 ea.
5 Gal.....	1030421	\$317.99 ea.

NUT FREE!



Bon Vital All Purpose Massage Cream

This all purpose massage creme is the perfect massage cream for professionals.

- Contains no nut oils or paraben preservatives
- Ideal lubricant offers the workability of an oil and absorbency of a lotion
- Superior quality, natural ingredients, and clean absorption
- Excellent for all modalities ranging from high glide to slow, deep tissue techniques
- Enriched with Arnica Extract and Squalane for therapeutic benefits

Trial Size	1003204	\$0.49 ea.
8 oz.....	1003203	\$14.49 ea.
½ Gal.....	1003251	\$46.99 ea.
1 Gal.....	1003201	\$78.99 ea.
5 Gal.....	1003202	\$334.99 ea.

NUT FREE!



Bon Vital Deep Tissue Massage Crème

Formulated for therapists who use a variety of massage modalities.

- Contains no nut oils or paraben preservatives, and water dispersible
- Thick consistency leaves a lasting glide
- Use a little less and this cream is versatile enough for most deep tissue techniques
- The special blend of seed oils provides high amounts of antioxidants and vitamins for the skin
- Enriched with Jojoba Oil for excellent skin care benefits

Trial Size	1003209	\$0.49 ea.
8 oz.....	1003207	\$12.99 ea.
½ Gal.....	1003208	\$49.99 ea.
1 Gal.....	1003205	\$75.99 ea.
5 Gal.....	1003206	\$329.99 ea.

Biotone Advanced Therapy Lotion

Hypoallergenic. Offers higher friction and less glide than oil, yet it won't absorb as fully or as fast as lotions. Perfect for longer massage sessions.

Gallon	43234	\$119.99 ea.
--------------	--------------	--------------



Mueller® Massage Lotion

Softens and soothes as it's absorbed into the skin. Greaseless emollient formula provides lubrication to make massage easier and more effective.

16 oz.....	43190	\$9.99 ea.
Gallon with Pump...	43189	\$52.99 ea.



Soft Tissue Massage Tools

Professional SMART Tools Set

Five piece set with emollient and new roll up case. This is a mix of double and single beveled edged tools, features a patent pending, double sided, single beveled handlebar tool and four various tools to be used for spinal and extremity regions. All tools are made of medical grade stainless steel.

Smart Tools

STM1—Palm sized tool is designed for use on smaller areas of the body, such as hands, feet, forearms, and calves. Weight: 9 oz.

STM2—Blade-like tool is designed for use on smaller to medium sized areas of the body, such as the back, forearms, neck, calves, and pectoral muscles. Weight: 11.2 oz.

STM3—This large tool is designed for use on larger areas of the body, specifically the lower extremity. Weight: 14.4 oz.

STM4—Much like its STM2 counterpart, this tool is designed for use on smaller to medium-sized areas of the body, such as the back, forearms, neck, calves, and pectoral muscles. Weight: 11.2 oz.

STM5—The STM5 is the smallest tool we offer, but it is also the most versatile. Weight: 7 oz.

Single 5-Piece Set	1006303	\$1,014.99 set
Clinic Bundle, Includes (4) 5-Piece Sets (1006303)		
.	1006304	\$4,234.99 set



Individual Smart Tools

STM1	1006589	\$289.99 ea.
STM2	1006590	\$289.99 ea.
STM3	1006591	\$332.99 ea.
STM4	1006592	\$289.99 ea.
STM5	1006593	\$289.99 ea.

HawkGrips Soft-Tissue Therapy Instruments

The HawkGrips Soft-Tissue Therapy Instrument promotes faster rehabilitation and recovery.

Treatment with the HawkGrips instruments can:

- Significantly increase range of motion
- Decrease pain
- Enhance athletic performance
- Remove unwanted scar tissue
- Breakdown fascial restrictions

A. Introductory Set

(3) Therapy instruments	(1) Hi-definition instructional video	
(1) Carrying case	(1) Easy-to-reference training manual	
(1) 8 oz. jar of emollient		
.62310	\$1,299.99 kit

B. Silver Set

(6) Therapy instruments	(1) Hi-definition instructional video	
(1) Carrying case	(1) Easy-to-reference training manual	
(3) 8 oz. jars of emollient		
.62309	\$2,499.99 kit

Individual Tools

Large Handlebar, HG0162297	\$679.99 ea.
Medium Handlebar, HG0262298	\$679.99 ea.
Small Handlebar, HG0362299	\$679.99 ea.
Small Multi Curve, HG0462300	\$529.99 ea.
Medium Multi Curve, HG0562301	\$529.99 ea.
Large Multi Curve, HG0662302	\$529.99 ea.
Boomerang, HG0762303	\$529.99 ea.
Scanner, HG0862305	\$529.99 ea.
Tongue Depressor, HG0962306	\$529.99 ea.



C. Gold Set

(7) Therapy instruments with midsize handlebar	(1) High-quality engraved foam tray	
(1) Carrying case	(1) Hi-definition instructional video	
(6) 8 oz. jars of emollient	(1) Easy-to-reference training manual	
.62308	\$3,199.99 kit

D. Platinum Set

(9) Therapy instruments	(1) High-quality engraved foam tray	
(1) High-quality bag	(1) Hi-definition instructional video	
(1) Carrying case	(1) Easy-to-reference training manual	
(10) 8 oz. jars of emollient		
.62307	\$4,199.99 kit

Emollients

HawkHydro, Single Use, 50/Pack	1032156	\$74.99 pkg.
HawkHydro Plus, Single Use, 50/Pack	1032157	\$74.99 pkg.
HawkGrips Emollient, 20 Jars43416	\$299.99 ea.
HawkGrips Emollient, 10 Jars43417	\$159.99 ea.
HawkGrips Emollient, 5 Jars43418	\$88.99 ea.

The Acuforce 2.5

This tool uses its own weight (2.5 lbs.) to provide pressure during treatments, saving your hands and wrists from injury and fatigue. The tool has two applications to perform muscle stripping, cross-fiber friction, and trigger point therapy. Made with a natural-feeling, skin-like material, it is nearly impossible to differentiate from the therapist's hand.

.....90529 \$59.99 ea.



The Massage Star™

- The wedge, on the top of the tool, to perform muscle-stripping and cross-fiber friction
- The wide and narrow points perform trigger point therapy and reflexology
- Works very well with massage creams and oils
- Instructional booklet included

11 oz.61682 \$25.99 ea.

XL, 16 oz.61697 \$42.99 ea.

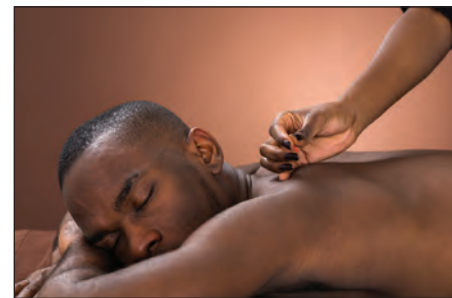

APS Dry Needles

APS Needles are safe, high quality, and the result is reduced pain during treatment and greater patient satisfaction. These needles have a good grip to ensure total control and are designed for smooth insertion to minimize tissue damage. This is because it features a headless needle for precision and a stiffer handle for better control. These sterile, single-use, disposable needles are made of surgical stainless steel. This allows for sharpness to be maintained during multiple insertions. They also have a triple lubricant coating making it a smooth and painless needle. There are different colored tips for easy identification.

Green Tip, 0.16 x 25 mm	1031561	\$16.99 ea.
Dark Purple Tip, 0.20 x 30 mm.....	1031562	\$16.99 ea.
Dark Pink Tip, 0.25 x 13 mm	1031563	\$16.99 ea.
Red Tip, 0.25 x 25 mm	1031564	\$16.99 ea.
Brown Tip, 0.25 x 30 mm	1031565	\$16.99 ea.
Yellow Tip, 0.25 x 40 mm.....	1031566	\$16.99 ea.
Gold Tip, 0.30 x 30 mm	1031567	\$16.99 ea.
White Tip, 0.30 x 40 mm	1031568	\$16.99 ea.
Pink Tip, 0.30 x 50 mm.....	1031569	\$16.99 ea.
Purple Tip, 0.30 x 60 mm.....	1031570	\$16.99 ea.
Black Tip, 0.30 x 75 mm.....	1031571	\$16.99 ea.
Blue Tip, 0.32 x 40 mm.....	1031572	\$16.99 ea.
Turquoise Tip, 0.30 x 100 mm.....	1031573	\$20.99 ea.

Acuforce 7.0

Introducing a breakthrough in therapy tool technology. Designed to use its own weight (7 lbs.) in applying pressure during therapy, it saves your thumbs, wrists, and elbows from fatigue. Performs muscle stripping, cross-fiber friction, and trigger point therapy. Made with a special skin-like material that works well with creams and oils.

.....90417 \$118.99 ea.

The Acuforce 7.0 Backpack & Carrying Case

.....90531 \$34.99 ea.



TheraCane

The amazing TheraCane self-massage tool makes it easy to apply pain-relieving deep compression directly to hard and knotted muscles called "trigger" points. Even if you have limited strength or mobility, the unique design of the TheraCane gives you the reach and leverage you need to reach muscles—even the hardest to reach muscles between your shoulders.

.....61726 \$66.99 ea.



Dongbang 17 Piece Deluxe Cup Set

Dongbang 17 Piece Deluxe Cup Set design from Korea contains plastic cups that are shock and heat resistant, which allows them to be sterilized in boiling water. Each cup also uses easy release air-locking valves. Cup sets include a pistol grip hand pump and carrying case.

Set includes:

- (13) 2" diameter cups
- (2) 1.8" diameter cups
- (1) 1.6" diameter cup
- (1) 1.3" diameter cup
- (1) 21" extension tube

..... 1006788 \$50.99 set

Hand Rollers & Massage Balls



Original Body Stick

Easy-to-use device designed to massage muscle tissue. Encourages increased circulation to muscle fibers before exercise, disperses lactic acid after workout, and diffuses muscle stiffness and knots. 15 rotating spindles for individuals with average body mass. Includes instruction sheet. 2 lbs. each.

.....61720 \$84.99 ea.



Big Stick

Easy-to-use device designed to massage muscle tissue. Encourages increased circulation to muscle fibers before exercise, disperses lactic acid after workout, and diffuses muscle stiffness and knots. 18 rotating spindles for individuals with heavy body mass. Includes instruction sheet. 2 lbs. each.

30"L.....61721 \$129.99 ea.



Marathon Stick

Easy-to-use device designed to massage muscle tissue. Encourages circulation to muscle fibers before exercise, disperses lactic acid after workout, and diffuses muscle stiffness and knots. 10 rotating spindles for individuals with lean body mass. Includes instruction sheet. 2 lbs. ea.

20"L.....61719 \$66.99 ea.



Pro-Tec 17.5" Roller Massager Travel Size

- Trigger point release grips
 - Effective tool for Myofascial release
 - Rounded grip ends provide precision trigger point release
 - 17.5" in length fits in most carry-on bags
 - Includes instructional brochure covering 20 massage and trigger point release techniques
-62180 \$24.99 ea.



Tiger Tail Muscle Massagers

- Helps accelerate muscle recovery
- Even, consistent distribution of pressure
- Saves fingers and hands from fatigue
- Closed cell, non-porous, non-absorbing, non-deteriorating foam
- Zero latex content
- Easy to clean
- Take it anywhere—portable, easy-to-pack design
- Made in USA and patent pending

18"62124 \$43.25 ea.

22"62125 \$49.45 ea.



TheraBand Roller Massager

This innovative tool is perfect for myofascial release and deep tissue massage. The Roller Massager can help increase blood flow and circulation in targeted areas, while also helping to increase muscle flexibility and range of motion. It fits easily into your bag, drawer, or glove box.

Standard.....62342 \$26.99 ea.

Portable.....62343 \$28.99 ea.



Pro-Tec 22" Roller Massager

- Trigger point release grips
- Perform a self-massage or Myofascial release
- Includes a full color instruction manual covering over 20 massage and trigger point release techniques for your entire body

.....61962 \$31.99 ea.



GOFIT® 18" Massage Bar

Ideal for before and after workouts! Rubberized bar has multi-directional massage patterns to deliver surface and deep tissue massage. Includes instructional booklet.

..... 53430-PS \$24.99 ea.



TheraBand Foot Roller

This affordable, simple, effective tool provides temporary relief from foot pain associated with common conditions and excessive activity. The natural latex material flexes to conform to the shape of your foot and deliver a custom massage.

Features:

- Ridges deliver a therapeutic foot massage
- 1.5" diameter shape is ideal for stretching the plantar fascia and toes to help increase flexibility
- Can be chilled or frozen to help reduce inflammation and pain
- Small and lightweight

Green62348 \$11.99 ea.



Pro-Tec Orb Deep Tissue Massage Ball

- Made of a high-density EVA foam with a contoured outer surface to prevent slippage
- Reduces muscle fatigue and tightness
- Promotes flexibility

5"62283 \$21.99 ea.



NEW!



GOFIT® 5" Massage Ball

Made of dense, lightweight foam with a solid core, the 5" massage ball targets virtually all muscle groups. The soft textured surface keeps it in place. Simply press and roll. Convenient and portable.

.....54347-PS \$18.99 ea.





TriggerPoint Foundation Collection

The TriggerPoint Foundation Collection includes the FootBaller, Baller Block, and two TP Massage Balls. These products target release areas and are highly effective when combined with the included easy-to-use self-care program. You will feel better and move better through deep tissue releases that improve flexibility and local circulation.

The TriggerPoint Foundations Collection includes:

FootBaller—A firm, compact roller perfectly sized for hands-free myofascial compression of the lower leg and foot.

Baller Block—Provides elevation for optimal range of motion and application of pressure when using TriggerPoint products. Also reduces space and houses the FootBaller when not in use.

Two TP Massage Balls—A versatile manipulation tool featuring a firm core wrapped in a cushioned material for targeted deep tissue stimulation. Access to the TriggerPoint Education Video Portal, which includes eleven instructional videos and a biomechanics video that explains the foundations of a self-massage program and how to release muscles that cause aches and pains in the lower leg, hips, and back.

..... 1005957 \$99.99 ea.



TriggerPoint Massage Ball

TP Massage Ball's primary focus is to assist in managing minor aches and pains of the muscle by applying pressure to general areas. Apply pressure with the ball by using the floor, wall, or any hard surface to stabilize movement of the ball. The TP Massage Ball is great for the neck, shoulders, back, chest, piriformis, calves, or anywhere that you have minor aches and pains.

- Mimics the feeling of a massage therapist thumbs
- Patented material changes its shape after 5–7 seconds of pressure to conform to your body

4", .03 lbs.....62270 \$32.99 ea.

NEW!

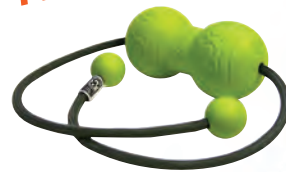

GOFIT® Trigger Ballx2

Relieves knots, trigger points, and muscle soreness. Dual cords help reach your back, shoulders, glutes, legs, and more in need of deep-tissue massage. No-slip rubber surface. Includes Trigger Ballx2 & therapy poster.

.....53430-PS \$24.99 ea.

Knotty Tiger

- Knotty Tiger has a hard, firm, and smooth surface; three different curves for differing amounts of pressure; and a non-slip grip feature
- Made in USA and patent pending

.....62126 \$24.99 ea.



Pro-Tec Massage Tools

- Heatable, deep tissue tools provide effective pain relief anytime
- Uses 100% natural acupressure and heat to release tight muscles and joints
- Boil or microwave for one minute to receive 60 minutes of soothing heat
- Relief for pain/tightness in neck, shoulders, back, leg, hips, and feet

Acuback 6.5" x 2.5" 1006012 \$43.99 ea.

Acuball, 3.5"..... 1006013 \$31.99 ea.

Acuball Mini 1.75" 1006014 \$20.99 ea.

Foam & Hardcore Rollers



Pro-Tec Y-Roller Foam Massager

The Pro-Tec Y Roller provides a post workout massage by targeting tight areas with an aggressive massage using either the dual or single ridge options.

- Dual or single ridge option offers a targeted aggressive massage
- Ability to roll in-between ridges for a less aggressive, moderate massage
- Deep tissue massage reduces muscle fatigue and tightness, promotes flexibility, and enhances performance
- Made from Elastomer a high-density, durable foam

6" x 15½" **.62282** \$54.99 ea.



Element Fitness 13" CORE Foam Roller

Includes a multiple pattern design to engage different muscle groups. Features a sturdy, 4", hollow core with a foam rubber layer. Built to last.

13"L x 5.5" Diameter **X16309-PS** \$35.99 ea.



The Grid

The most versatile and comprehensive foam roller and workout tool available. Provides the perfect blend of portability and size, but can support more than 500 lbs. of weight. Massage your lats, quads, lower back, or any other large muscle group, or achieve a killer core body workout.

- Features Distrodensity Zones, a matrix of varying widths and densities that allows for a precision massage based on individual needs
- Designed to withstand constant, heavy, and repeated use without breaking down
- Backed by a 1-year warranty against manufacturing defects

13"L x 5"D
 Black **.62265** \$54.99 ea.
 Orange **.62266** \$50.99 ea.

The Grid 2.0

26"L x 5"D
 Black **.62267** \$87.99 ea.
 Orange **.62268** \$87.99 ea.



GOFIT® Pro Deep Tissue Accupoint Massage Roller

Massage pressure is distributed across nodules maintaining stability for heavy use. Helps blood to quickly flood the muscles to speed up recovery. Made of closed cell, lightweight, dense foam. Includes manual.

13"L x 5.75"D..... **X17301-PS** \$24.99 ea.

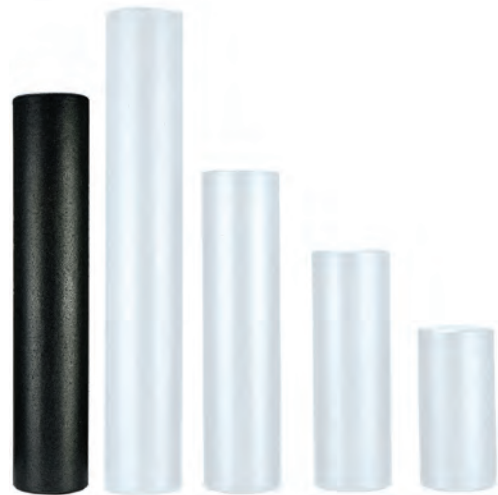

Cando Foam Rollers

Foam rollers are perfect for positioning, balance, postural and muscle re-education, spinal stabilization, body awareness, and coordination, and ranging and strengthening activities. Black rollers are made with a lighter material.

White, 6" x 48" **.62357** \$32.99 ea.
 White, 6" x 30" **.62354** \$20.99 ea.
 White, 6" x 24" **.62355** \$18.99 ea.
 White, 6" x 18" **.62356** \$16.99 ea.
 Black, 6" x 36" **.62358** \$25.99 ea.



Foam Rollers

One of the most widely used therapeutic and conditioning products available. The rollers easily adapt to a variety of techniques, including mobilization, balance, and strength training.

Foam Roller
 6" x 36" **.61221** \$24.99 ea.
 Half Foam Roller
 6" x 36" **.61222** \$15.99 ea.

Exercise Balls



GOFIT® Guide Roller

Made of a super high-density foam designed for deep tissue massage and heavy use. Beneficial for muscle recovery and regeneration. Improves alignment and hip mobility. 12 printed exercises.

24"L x 6"D **X17300-PS** \$34.99 ea.

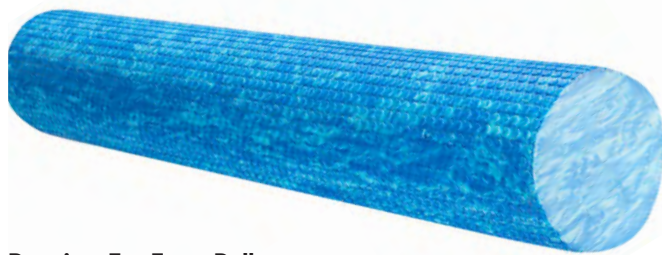

Premium Eva Foam Rollers

Resilient, nonporous! Top-of-the-line foam rollers made of heat-sealed EVA foam to maintain shape and resist moisture/bacteria. The smooth surface cleans easily with an antibacterial cloth. Heat-sealed EVA foam construction. 1 lb. each. Color: Blue.

6" x 36", Round **.61722** \$61.99 ea.

6" x 12", Round **.61724** \$26.99 ea.



Element Fitness EVA Foam Roller

A premium EVA foam roller with raised texture for effective massage and loosening of tight muscles. Ideal for Pilates workouts, as well.

18"L x 6" Diameter **X16307-PS** \$27.99 ea.

36"L x 6" Diameter **X16308-PS** \$44.99 ea.



Pro-Tec Foam Rollers

- Great tool for stretching, promoting flexibility and Myofascial Release
- Alleviates muscle and soft tissue tightness of the upper and lower back, IT band, hamstring, adductors, upper arm, and much more
- Stretches muscles and tendons, breaks down soft tissue adhesion, and soothes tight fascia while increasing blood flow and circulation to the soft tissues
- 4" helps to provide a more focused deep tissue massage

A. Gold, 4" x 12" **.61956** \$11.99 ea.

B. Blue, 6" x 18" **.61957** \$20.99 ea.

C. Pink, 6" x 18" **.61958** \$20.99 ea.

D. Blue, 6" x 35" **.61960** \$22.99 ea.

E. Blue (Half Round), 6" x 12" **.61961** \$13.99 ea.

F. Black (Extra Dense), 6" x 36" **.62177** \$40.99 ea.

Six Roller Pack- 2(B) - 2(C) - 1(D) - 1(F) from above

..... **X66814** \$144.99 Pk.



Foam Roller Storage Rack

Rack comes with casters and holds 12 6" diameter foam rollers.

35" x 21" x 36" **X16766-PS** \$149.99 ea.

Stretching



ProStretch® Large PT-500

Constructed of hand-crafted wood and accommodates shoe sizes of 14 and up.

..... **.61060** \$174.99 ea.

ProStretch Double PT-500D

..... **.61665** \$349.99 ea.



ProStretch® Plus™

The ProStretch Plus delivers unparalleled benefits. The adjustable toe lift provides superior plantar fascia and toe stretch; the adjustable, elevated heel rest increases stability and customizes fit; and a larger platform safely and comfortably fits any shoe size, large or small, allowing for static and progressive stretching without readjusting the foot.

..... **.62184** \$54.99 ea.



ProStretch® Single PT-100

The only device to provide the kind of stability and support necessary for proper stretching of the lower leg muscle-tendon complexes. ProStretch isolates muscle groups and allows user to govern the degree of stretch. Its rocker design makes it the easiest way to reach the Achilles tendon and the plantar fascia.

..... **.61031** \$42.99 ea.

ProStretch Double PT-200

..... **.61000** \$94.99 ea.

Cando Wooden Incline Board

Provides a convenient platform for stability exercise, and is great for therapy and strength treatments.

- Adjustable Incline Board has 14" x 18" foot board
- Non-slip bottom surface
- Positive lock adjustment handles
- 5°, 10°, 15°, 20°, 25° adjustment levels
- Made with high-quality materials for great durability

..... **.62285** \$194.99 ea.



TheraBand® FlexBar

A flexible, durable resistance device with a ridged surface for enhanced grip during use. Not only will it help your grip and stabilization, it has been research-proven effective for Tennis Elbow.

Features:

- Perfect for wrist, forearm, and hand rehabilitation
- Available in three levels of resistance
- Economic and simple tool for exercises such as activity simulations, wrist abduction, thumb strengthening, eccentric twists, and soft tissue manipulation
- Lightweight, easy-to-grip, portable resistance exerciser for rehabilitating and strengthening hands, wrists, forearms, shoulders, and elbows

Size 12"

Light Force, Red . . . **.61193** \$17.99 ea.

Med. Force, Green . . . **.61194** \$19.99 ea.

Hard Force, Blue. . . **.61195** \$38.99 ea.



Foot Gym

The Foot Gym is an all-in-one device that offers a combination of seven different exercises, stretches, and massage therapy. Target plantar fasciitis, Achilles tendonitis, and other foot injuries, while improving overall foot function with the Foot Gym. Great for rehab or post-surgery recovery. No batteries required. Light, 3.3 pound weight allows for easy portability.

13" x 6.5" x 5.5" . . **1003502** \$72.99 ea.



BAPS Board

Biomechanical Ankle Platform System (BAPS) is a scientifically designed program that produces controlled, calibrated, and predictable stress on the lower leg, ankle, and foot. Four, 2½ lb. weight plates are included for resistive weight training, and can also be used as passive assistance into the range of motion if space is lacking.

Contents:

- (5) Hemispherical attachments
 - (4) 2½ lb. weight plates
 - (2) Weight rods
 - (1) Wall mount
- **.61030** \$897.99 ea.



NEW!

TheraBand Stretch Strap

The TheraBand Stretch Strap enables more effective static and contract-relax stretches while increasing range of motion and flexibility of muscles. It allows you to comfortably stretch further and longer than would be possible without an aid. This simple, innovative, and multi-purpose tool negates the need for static-only stretching straps, and also allows for effective stretching of all connective tissues.

- The TheraBand Stretch Strap with loops provides a more comfortable and beneficial dynamic stretch of major muscles, like Gastrocnemius, Rectus Femoris, Soleus, and Hamstring
- The small & large loops enable users to securely, correctly, and comfortably hold positions
- Supports a variety of hand, foot, and toe holds to deliver significant stretch without the help of a partner
- Used by dancers, gymnasts, and other athletes to improve range of motion and flexibility
- Includes instruction booklet written by a licensed physical therapist, detailing stretching exercise and targeted muscles

58"L x 1"W..... **1035327** \$25.99 ea.



Stretch Out Strap

The patented Stretch Out Strap delivers the benefits of assisted stretching without a partner. Multiple loops permit deep, gradual stretching of major muscle groups with greater safety, control, and effectiveness than is possible unaided. Strap comes with the Stretch Out Strap Guide, which features over 30 stretches emphasizing contract-relax techniques.

Instructional guide:

- New color photos
- Over 30 stretches featuring contract-relax techniques
- Anatomical illustrations for quick reference
- Softcover, 40 page booklet

..... **62127** \$29.99 ea.



CoreStretch™

- Delivers the deepest, most effective way to stretch your lower back, hips, and hamstrings
- Allows the tissues to relax and elongate
- Develops the major muscle groups that make up the core
- Results in a stretch that helps to increase range of motion, prevent injury, speed recovery, and reduce pain

..... **62188** \$86.99 ea.



SPRI® XerStretch® Strap

The 1" wide nylon strap includes loops at each end for hands and a center loop to keep the foot securely in place.

..... **53899-PS** \$9.59 ea.



Body Sport Stretch Strap

The strap helps induce a more effective, dynamic stretch. Use to deepen yoga poses, athletic training or pre-workout stretches.

..... **16732-PS** \$15.99 ea.



Stretching Posters

Large photos with concise instructions clearly explaining proper form. Laminated.

36"L x 24"W

Upper Body Poster

14 stretches..... **52862-PS** \$23.99 ea.

Lower Body Poster

13 stretches **52863-PS** \$23.99 ea.

Balance



Element Fitness SlideMate Horizontal Trainer

Includes the durable, super slick slideboard and a pair of nylon booties. Measures 6' long.

.....**.16952-PS** \$104.99 ea.



Power Systems Premium Slide Board

An effective way to prevent hip and knee injuries, while also enhancing power and speed. Two high-quality molded deceleration ramps provide stable surface for change of direction. Soft booties or socks can be used on the board. Includes adjustable slide board, 2 ramps, 1 pair of booties.

Features:

- Built-in handle for easy transport
- One piece
- Adjustable from 5 to 8 feet long
- High-density polyethylene sliding surface with non-skid backing
- White with black stoppers

24"W..... **1033837** \$546.99 ea.



Pro Fitter Rehabilitation Program

Helps users to regain strength and proprioception after hip, knee, and ankle injuries. Improves stability after back, shoulder, and neck injuries.

The Pro Fitter is 100% assembled and includes:

- Rocking Base Pro Fitter with fully independent flexing/rotating foot pads and six instantly adjustable tension settings
- Attachable, padded platform for sitting and standing
- 29-minute video outlining both fitness and rehabilitation applications
- Information kit with 2-year limited warranty and laminated exercise chart

.....**.61172** \$954.99 ea.



TheraBand® Rocker and Wobble Boards

These new boards from TheraBand provide balance and proprioception training for upper and lower extremities. The Rocker Board provides uni-directional challenge, while the Wobble Board provides multi-planar challenge. Made of molded plastic, both products feature a sensory stimulation surface on the top, a lightweight product design, and an anti-skid surface on the bottom that resists slipping on smooth floors.

Rocker Board, 14" x 14" Top Surface..... **.61631** \$86.99 ea.

Wobble Board, 16" diameter Top Surface **.61632** \$83.99 ea.



15" Tri Level Balance Board

Adjusts to 3 heights!

15" diameter board made from molded ABS construction with textured top for grip. Increase challenges by adjusting up to 4" maximum.

.....**.13071-PS** \$29.99 ea.



Stability Trainer™ by TheraBand®

Oval-shaped, color-coded foam pads in three densities to provide a progressive system of balance training. Closed cell foam pads with an anti-slip ridged surface and oval foot fitting shape. Effective for balance training in older adults, rehabilitation of lower extremities, and sports performance enhancement.

Firm (green), 14½" x 8" x 1¾" **61262** \$37.99 ea.
 Soft (blue), 16" x 9" x 2" **61261** \$37.99 ea.



TheraBand® Extra Soft Stability Trainer™

Air-filled to provide multiple directional displacement and challenge. Made of durable PVC, its oval-shape and heavy-gauge side walls help the ankle resist the tendency to roll during exercise.

- Rounded points provide tactile inputs for sensorimotor training
 - Opposite surface features anti-skid bars that resist slipping
- 17¼" x 10½" x 2½"
 Black **61629** \$54.99 ea.



AIREX® Balance Pad

A simple, yet effective therapy and training tool. The destabilizing properties of the "super-soft" specialty foam help restore motor skills and balance.

20" x 16.4" x 2.5"
 Approximate Weight: 1.6 lbs. **61644** \$85.99 ea.



AIREX® Balance Beam

Utilizes the "super-soft" foam of the Balance Pad and extends it to create the newest balance training product. The extended length provides a walking base for exercise and rehab to work on gait and dynamic balance.

63" x 6" x 2.5"
 Approximate Weight: 3 lbs. **61643** \$164.99 ea.



Wobble Board Stand

Keeps boards neatly stored and easily accessible. Holds all five boards.
 **90293** \$89.99 ea.
 Full Set with Stand. **61176** \$389.99 kit

16" Wobble Board

Advanced level. 16" birch disc with three angulation levels: 15, 17 and 20 degrees. 360 degrees, for use on one leg or two.
 **61175** \$99.99 ea.

20" Wobble Board

- Intermediate level
 - Three angulation levels: 10, 12 and 15 degrees
 - 360 degrees, for use on one leg or two
- **61174** \$101.99 ea.



Dyna-Disc

While remaining in the safety of their chair, the user can experience many of the same benefits of a gym ball for performing lower back/pelvic stabilization and weight shift exercises.

14" Diameter
 Blue **61224** \$47.99 ea.
 Green **61223** \$47.99 ea.
 Meadow Green **61955** \$47.99 ea.
 Mullberry **61954** \$47.99 ea.
 24" Diameter
 Blue Plus. **61274** \$83.99 ea.

Not made with Natural Rubber Latex.

Balance



SPRI® Balance Pods

Arrange with flat side down or up for varied levels of difficulty. Pods are made from heavy duty vinyl, air injected. Assorted color pods. Includes instruction sheet.

6.25" x 3.5"

Set of 6 **.13051-PS** \$42.99 set



Element Fitness Balance Pods

Use on either side for varied levels of difficulty. Vinyl construction with tactile top and smooth bottom. Approximately 7" each.

..... **.13153-PS** \$19.99 pr.



Mini Trampoline

Features a 38" diameter sturdy steel frame, heavy duty polypropylene jumping mat, and bungee straps for great rebound! Some assembly required. Unit weighs 17.5 lbs.

..... **X52087-PS** \$66.99 ea.



Stephanie Joanne Trampoline

Rebound to strengthen the heart and muscles. Strong steel base folds for storage with durable safety apron and a 27" diameter jumping area. Trampoline measures 40" in diameter and 10" in height. Includes stabilizer bars for balance that are easy to remove. Max. weight capacity is 225 lbs. Class Pack includes 12 trampolines and ships by truck.

..... **.16953-PS** \$121.99 ea.
 Class Pack **T16954-PS** \$1,349.99 pk.



Terra Core™ Workout System

The Terra Core is designed to work by itself or incorporated with resistance bands, dumbbells, kettlebells, and more to create the most dynamic workout circuits imaginable. The elongated design means you can engage more of your muscle groups. Flip it over to use the built-in handles—close set or wide—for pushups and more. Weighs 28 lbs. Weight capacity 500 lbs. Includes access to free fitness app, instructions, and pump.

46"L x 17"W x 10"H

Single **X16955-PS** \$199.00 ea.
 Rack Only **T16956-PS** \$299.00 ea.
 Package, Six Trainers w/Rack **T16957-PS** \$1,449.00 pk.



BOSU® Pro Balance Trainer

BOSU® Pro Balance Trainer challenges the entire body with integrated, multi-joint movement that requires muscle groups to work together. Use the BOSU® Pro Balance Trainer dome or platform side down, combine it with other equipment, or use it as a stand-alone product to make any exercise fun, challenging, and effective. Inflates up to 9" high with a 26" diameter. Maximum weight capacity 350 lbs. 1 year limited warranty.

- Single Pro Trainer **.52276-PS** \$159.95 ea.
- Pro Trainer, 4 pack **.52277-PS** \$599.99 pk.
- Pro Trainer, 16 pack **X52244-PS** \$2,019.99 pk.
- Pro Trainer, 6 Pack, DVD, & Cart **X51022-PS** \$999.99 pk.



BOSU® Sport Balance Trainer

Constructed with the same rim and base style. The sleek, compact design allows for easy transportation and storage. The smaller size offers a variety of configuration, stance, and workout options. Inflates up to 7" high with a 22" diameter. Maximum weight capacity 250 lbs. 90 day limited residential warranty. Includes trainer, foot pump, and manual.

- **.52907-PS** \$99.99 ea.
- 4 pack **.54315-PS** \$388.99 pk.

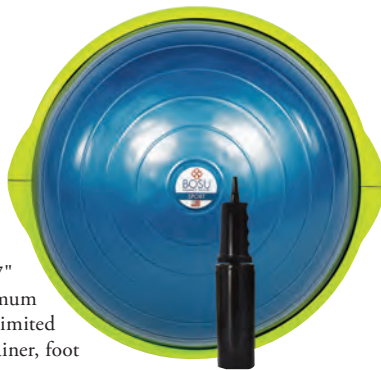

Balance Dome

Use for multiple exercises and can be placed upside down for additional Adaptive PE activities. Made from strong vinyl construction. Dome measures 8" high when inflated and has a 17.5" diameter.

- **.16669-PS** \$46.99 ea.



BOSU® NexGen™ Balance Trainer

Rated for recreational and personal use, the BOSU Balance Trainer gives you all of the functionality and options received from the Pro model, while keeping costs low. Holds up to 300 lbs., 10" x 26"D (inflated). Weighs 19 lbs. Includes hand pump and manual.

- Single Trainer **.54313-PS** \$109.99 ea.
- Balance Trainer, 4 pack **.54314-PS** \$439.99 pk.



BOSU® NexGen™ Pro Balance Trainer

Four easy to distinguish quadrants allow for precise body positioning for cardio, agility, strength, core, and more! Markings also enhance hand and foot grip. Heavy-duty commercial grade materials. Holds up to 350 lbs., 10"H x 26"D (inflated). Weighs 19 lbs. Includes hand pump and manual.

- Single Pro Trainer **.54311-PS** \$169.99 ea.
- Pro Trainer, 4 pack **.54312-PS** \$679.99 pk.



BOSU® Storage Carts

Storage carts are made of heavy-duty gauge steel with swivel casters. Single column stores six Bosu Trainers, measures 24"L x 20.5"W x 71.5"H, and weighs 16 lbs. Two column stores 14 Bosu Trainers, measures 49.5"L x 25"W x 76"H, and weighs 58 lbs.

- Single Column **X51021-PS** \$187.99 ea.
- Two Column **.54316-PS** \$299.00 ea.

Exercise Bands



TheraBand® CLX™ Station

The TheraBand CLX Station is designed for in-clinic strength training, range of motion and flexibility exercises. The vertical, wall-mounted slide track provides adjustable anchor points and prescription markers for patient tracking. This compact, total body rehabilitation system features the familiar and trusted color progression and resistance levels of TheraBand CLX.

Includes:

- (2) 42" Anodized aluminum wall tracks with slide track connections
- CLX™ station full-color poster
- (7) TheraBand CLX (colors: yellow, red, green, blue, black, silver, gold)
- CLX station anchors
- Accessory rack
- Installation instructions

..... 1030414 \$508.99 set

TheraBand® CLX—Continuous Loops

Delivers versatility and ease of use that increases exercise compliance to improve patient outcomes. A FREE integrated CLX app provides an exercise library with support tools to enhance any rehab or training program.

Features & Benefits:

- All-in-one product delivers versatility and value
- Integrated app
- Simplicity increases compliance and use
- Consecutive loops allow hands-free
- Construction is more durable than competitors
- Resistance increases in 25% intervals

Individual, 5' each

Yellow/Thin	1003215	\$10.49 ea.
Red/Medium	1003216	\$10.49 ea.
Green/Heavy	1003217	\$10.49 ea.
Blue/X-Heavy	1003218	\$11.49 ea.
Black/Special Heavy	1003219	\$14.49 ea.
Silver/Super Heavy	1003220	\$14.49 ea.
Gold/Max	1003221	\$15.99 ea.

TheraBand® CLX Anchor

The CLX Anchor expands the capabilities and increases the number of movements that can be performed with TheraBand CLX. It is specifically designed to anchor the CLX in a door or to a sturdy object. Built with a soft cradle and two end straps to hold the CLX in place, the anchor is a versatile accessory that easily allows patients to transition in-clinic exercises to the home or wherever convenient with minimal investment.



..... 1030413 \$9.99 ea.

TheraBand® Sport Handles

Allows for two hands to grip it easily. 12" Long.



..... 61650 \$15.99 ea.

TheraBand® Shoulder Pulley

Features a unique rope that's divided into sections by distinct black marks. By referencing the position of these marks during exercise, patients get immediate feedback on progress. As they move from one black mark to the next during the course of rehab, they can literally see how much their range of motion is improving.



..... 61963 \$18.99 ea.



Bulk, 25 yards each

Yellow/Thin	1003337	\$131.99 ea.
Red/Medium	1003338	\$141.99 ea.
Green/Heavy	1003339	\$154.99 ea.
Blue/X-Heavy	1003340	\$174.99 ea.
Black/Special Heavy	1003341	\$204.99 ea.
Silver/Super Heavy	1003342	\$229.99 ea.
Gold/Max	1003343	\$264.99 ea.

 Not made with Natural Rubber Latex.

NEW!



Sports Health™ Fitness Band Loops

Their light weight, durability, and ease of use make fitness loops ideal for sculpting glutes and legs, stretching, and rehabilitation.

12" L x 2" W

X-Light, Green17360-PS	\$2.99 ea.
Light, Blue17361-PS	\$3.25 ea.
Medium, Yellow17362-PS	\$3.50 ea.
Heavy, Red17363-PS	\$3.75 ea.
X-Heavy, Black17364-PS	\$3.99 ea.

Fitness Band Loop Packs

Blue, 12 Light Bands66802-PS	\$33.99 pk.
Yellow, 12 Medium Bands66803-PS	\$37.99 pk.
Red, 12 Heavy Bands66804-PS	\$39.99 pk.
Essential—4 Light, 4 Medium & 4 Heavy66805-PS	\$38.99 pk.
Total Pack—20 bands (4 of each color)66805-PS	\$59.99 pk.



TheraBand® Band Loops

These continuous loop elastic bands lay flat. TheraBand elastic loops are 3" wide loops that can be used for a variety of applications, particularly lower body exercises to increase strength and balance.

Yellow, 12"62349	\$6.99 ea.
Red, 12"62350	\$7.99 ea.
Green, 12"62351	\$9.49 ea.
Blue, 12"62352	\$10.49 ea.



Versa-Loops

- The six different colors each provide a different level of resistance
- Exercises that target the legs, core, arms, and back
- Cost effective and space saving
- Adaptable, suitable for all levels of exerciser
- Comprehensive, all-body exercise tool

Extra Light, Orange62253	\$4.99 ea.
Light, Lime Green62254	\$5.49 ea.
Medium, Red62255	\$5.99 ea.
Heavy, Blue62256	\$6.99 ea.
Extra Heavy, Purple62257	\$6.99 ea.
Ultra-Heavy, Gray62258	\$6.99 ea.

Sports Health™ Fitness Mega Bands

Resistance band loops are an ideal way to build strength, tone muscle, and rehab injuries without the hassle of heavy metal free-weights. Comes in a wide variety of resistance levels.

41" long and 3/8" thick

5-15 lbs., .25"W, Yellow17231-PS	\$9.99 ea.
15-25 lbs., .5"W, Red17232-PS	\$12.99 ea.
25-50 lbs., .8"W, Green17233-PS	\$15.99 ea.
35-70 lbs., 1.25"W, Black17234-PS	\$19.99 ea.
50-125 lbs., 1.75"W, Lime Green17235-PS	\$24.99 ea.
65-175 lbs., 2.5"W, Blue17236-PS	\$28.99 ea.
85-230 lbs., 3.25"W, Orange17237-PS	\$35.99 ea.
120-300 lbs., 4"W, Grey17238-PS	\$39.99 ea.



Exercise Bands



TheraBand® Resistive Exercise Bands

Progressive resistance exercise program. The 5½" width evenly distributes pressure.

See **COLOR PROGRESSION** for Resistance
Latex

Yellow, 6 yds.	61083	\$14.49 ea.
Yellow, 50 yds.	61003	\$93.99 ea.
Red, 6 yds.	61084	\$16.99 ea.
Red, 50 yds.	61007	\$95.99 ea.
Green, 6 yds.	61085	\$17.99 ea.
Green, 50 yds.	61008	\$105.99 ea.
Blue, 6 yds.	61086	\$17.99 ea.
Blue, 50 yds.	61009	\$121.99 ea.
Black, 6 yds.	61087	\$19.99 ea.
Black, 50 yds.	61010	\$131.99 ea.
Silver, 6 yds.	61088	\$29.99 ea.
Silver, 50 yds.	61011	\$169.99 ea.
Gold, 6 yds.	61065	\$41.99 ea.
Gold, 50 yds.	61066	\$239.99 ea.

Not made with natural rubber latex

Yellow, 50 yds.	62317	\$99.99 ea.
Red, 50 yds.	62318	\$94.99 ea.
Green, 50 yds.	62319	\$104.99 ea.
Blue, 50 yds.	62320	\$124.99 ea.
Black, 50 yds.	62321	\$132.99 ea.

Seven Piece Set

Each band is 6 yds. long. Contains one each: Yellow, Red, Green, Blue, Black, Silver, and Gold. **61089** \$134.99 set



Sup-R Band®

Sup-R Band is made from a premium formula and excels compared to other exercise bands.

- Made of Thermoplastic Elastomer (TPE)
- Color-coded in TheraBand® colors
- Roll is packaged in a dispenser box

See **COLOR PROGRESSION** for Resistance

Yellow, 5 Yds.	55609	\$12.99 ea.
Yellow, 25 Yds.	55794	\$94.99 ea.
Red, 5 Yds.	56018	\$14.99 ea.
Red, 25 Yds.	55795	\$104.99 ea.
Green, 5 Yds.	55790	\$15.99 ea.
Green, 25 Yds.	55797	\$104.99 ea.
Blue, 5 Yds.	55792	\$16.99 ea.
Blue, 25 Yds.	55799	\$118.99 ea.
Black, 5 Yds.	55793	\$17.99 ea.
Black, 25 Yds.	55800	\$126.99 ea.



Cando Exercise Bands

Bands are 6" wide by 6 or 50 yards.

See **COLOR PROGRESSION** for Resistance

Red, 6 yds.	52260-PS	\$10.99 ea.
Red, 50 yds.	52264-PS	\$66.99 ea.
Green, 6 yds.	52261-PS	\$11.99 ea.
Green, 50 yds.	52265-PS	\$72.99 ea.
Blue, 6 yds.	52262-PS	\$12.99 ea.
Blue, 50 yds.	52266-PS	\$79.99 ea.
Black, 6 yds.	52263-PS	\$13.99 ea.
Black, 50 yds.	52267-PS	\$89.99 ea.
Six Band Pack includes one light, two medium, two heavy, and one extra heavy 6 yard roll.	52173	\$16.43 pk.

COLOR PROGRESSION-Resistance in Pounds: at 100% Elongation

YELLOW 3 lbs.	RED 3.7 lbs.	GREEN 4.6 lbs.	BLUE 5.8 lbs.	BLACK 7.3 lbs.	SILVER 10.2 lbs.	GOLD 14.2 lbs.
BEGINNER			INTERMEDIATE		ADVANCED	



Sports Health™ Resistance Tubing

Sturdy tubing with foam covered plastic handles and web strapping for comfort and grip. Color coded for easy identification. 48" long. Six tube pack contains one Extra Light, two Light, two Medium, and one Heavy tube. Steel rack is 24"L x 2"W. Five 12" pegs will hold 100 tubes. Mounting hardware included.

X-Light, Yellow	53123-PS	\$4.87 ea.	X-Heavy, Black	53164-PS	\$7.47 ea.
Light, Green	53124-PS	\$5.67 ea.	6 Tube Pack	66594-PS	\$34.97 pk.
Medium, Red	53125-PS	\$6.07 ea.	Wall Rack	36172-PS	\$34.97 ea.
Heavy, Blue	53126-PS	\$6.67 ea.			

Not made with Natural Rubber Latex.



Smart Guard™ Sleeved Tubing

Rubber-dipped tubing encased in nylon sheathing with plastic handles and reinforced web straps. 4' long.

Light, Lime Green	16864-PS	\$17.95 ea.
Medium, Red	16865-PS	\$18.95 ea.
Heavy, Dark Blue	16866-PS	\$19.95 ea.
Extra Heavy, Black	16867-PS	\$20.95 ea.
Tubing 4 Pack, one of each resistance	16868-PS	\$71.99 pk.





Cando Exercise Tubing

This exercise tubing works wherever traditional bands and tubing are used. Designed with children in mind, resistance is standard for the therapy industry. Choose from 25' and 100' tubing lengths.

Tan, 25 ft.61942	\$10.99 roll
Tan, 100 ft.61947	\$40.99 roll
Yellow, 25 ft.61943	\$22.99 roll
Yellow, 100 ft.61948	\$64.99 roll
Red, 25 ft.61944	\$22.99 roll
Red, 100 ft.61949	\$70.99 roll
Green, 25 ft.61945	\$23.99 roll
Green, 100 ft.61950	\$79.99 roll
Blue, 25 ft.61946	\$26.99 roll
Blue, 100 ft.61951	\$87.99 roll

TheraBand® Exercise Tubing

TheraBand® is packaged 25 feet/box or 100 feet bulk rolls for the trainer or physical therapist. Color coded.

Yellow, 25 ft., 3/16" O.D.61074	\$14.99 box
Yellow, 100 ft.61012	\$59.99 roll
Red, 25 ft., 3/16" O.D.61075	\$17.99 box
Red, 100 ft., 3/16" O.D.61018	\$60.99 roll
Green, 25 ft., 5/16" O.D.61076	\$18.99 box
Green, 100 ft.61025	\$66.99 roll
Blue, 25 ft., 3/8" O.D.61077	\$20.99 box
Blue, 100 ft., 3/8" O.D.61026	\$75.99 roll
Black, 25 ft., 7/16" O.D.61078	\$22.99 box
Black, 100 ft., 7/16" O.D.61027	\$86.99 roll
Silver, 25 ft., 1/2" O.D.61029	\$26.99 box
Silver, 100 ft., 1/2" O.D.61028	\$101.99 roll



Cando Digi-Extend 'n' Squeeze Finger and Hand Exerciser Ball

This exercise ball helps develop isolated finger strength, flexibility, and coordination for rehabilitation of carpal tunnel, arthritis, stroke, fractures, tendon injuries, nerve lacerations, tennis elbow, and more.

Features:

- Ergonomically shaped to fit hands & fingers
- Combines flexion and extension for exercising hands and fingers
- Greater versatility helps strengthen grip and increase dexterity and mobility
- Improves fine and gross motor skills
- Strengthens hands and fingers
- Increases circulation

Extra-Lite, Yellow62288	\$18.05 ea.
Lite, Red62289	\$18.05 ea.
Moderate, Green62290	\$18.05 ea.
Heavy, Blue62291	\$18.05 ea.
Extra Heavy, Black62292	\$18.05 ea.

NEW!



The Pronator

The Pronator can use any dumbbell, TheraBand or cable machine in your Training, or Gym. This hand-held tool offsets the resistance, creating a rotational component for shoulder, forearm, and wrist exercises. You can use it to challenge athletes recovering from injury or trying to take their game to the next level. You can easily exchange the weight, making it ideal to use in a busy training room.

Designed by a sports physical therapist to optimally strengthen:

- Wrist pronation and supination
- Wrist radial and ulnar deviation
- Elbow flexion and extension
- Shoulder internal and external rotation
- Scapular stabilizers



The Pronator (1) 1035323	\$76.99 ea.
The Pronator Clinical Set (2 pair) 1035324	\$133.99 set

Not made with Natural Rubber Latex.

Medicine Balls/Rebounders



TheraBand® Pro Series SCP™ Exercise Ball

The TheraBand Pro Series SCP™ Exercise Ball is the latest offering in ball technology. Used to strengthen muscles, to improve posture, and help prevent back pain. Increases flexibility, coordination, and helps develop strength.

Each ball is constructed of high-quality vinyl with latitudinal ribs for easier grasping. Each exercise ball comes with two plugs and an inflation adapter, along with the TheraBand Exercise Ball Guide Poster detailing 24 exercises.

17½", Yellow62335	\$25.99 ea.
21", Red62336	\$35.99 ea.
25", Green62337	\$41.99 ea.
29", Blue.....	.62339	\$49.99 ea.
33", Silver.....	.62341	\$56.99 ea.



Cando Wate Balls

- Color-coded weighted balls
- Small and flexible enough to grasp with one hand, yet big enough to hold with two
- 5" diameter
- Balls are soft and easily conform to your grasp
- Use a pump to inflate/deflate to make ball harder/easier to grasp

1.1 lbs., Tan62215	\$10.35 ea.
2.2 lbs., Yellow62216	\$11.95 ea.
3.3 lbs., Red62217	\$13.35 ea.
4.4 lbs., Green.....	.62218	\$14.90 ea.
5.5 lbs., Blue62219	\$16.30 ea.
6.6 lbs., Black62220	\$17.85 ea.
6-Piece Set (Rack Not Included).....	.62222	\$83.60 set
Wate Ball Rack62223	\$66.99 ea.



Exertools PlyoBack Reflex

Made of 14-gauge, double-welded steel, and ground to a perfect, flush look and feel. An integrated training station, including a balance station, an angled plyometric jump station, a jogging station, and medicine ball rebounder, all in one.

- Heavy-duty frame made of fourteen gauge double welded steel
- Eight pre-set settings from zero to sixty degrees
- Stabilization handle for support
- 40 springs allow return of balls and comfortable standing surface
- Offers a fully enclosed adjusting system
- 40" tramp frame with 32" square, which provides a responsive rebounding surface
- Warranty: 2 years base, 2 years moving parts, 1 year regular use

58" x 58" x 8"62275	\$1,019.99 ea.
----------------------	---------------	----------------

PlyoBack™ Elite Package

Includes five balls (2, 4, 7, 11, and 15 lbs.), a ball rack, a PlyoBack, and a reference book

.....	*61728	\$1,584.99 ea.
-------	---------------	----------------

* Direct-ship item. Please allow additional time to receive.



Cando Rebounders

These adjustable angle rebounders can be used as a plyometric ball return or as an exercise trampoline. It has a T-bar for upper extremity support when used as a trampoline. Returns ball with speed, force, and angle consistent with throw.

- Angle adjust: 0–60 degrees (any angle)
- 250 lbs. weight capacity

Square Rebounder

39" diagonal surface, 27.5" x 27.5".....	.62224	\$452.99 ea.
------------------------------------------	---------------	--------------

Square Rebounder with 5 Ball Set

Includes 2, 4, 7, 11, and 15 lbs.....	.62225	\$754.99 set
---------------------------------------	---------------	--------------

Round Rebounder

27" diameter rebounder surface.....	.62226	\$536.99 ea.
-------------------------------------	---------------	--------------

Round Rebounder with 5 Ball Set

Includes 2, 4, 7, 11, and 15 lbs.....	.62227	\$695.99 set
---------------------------------------	---------------	--------------

Medicine Balls/Rebounders



TheraBand® Soft Weight Set

Designed with a soft cover and pliable filler free of any hard edges or rims. Used for strengthening, plyometrics, balance training, mobilization, and functional grip strength development. Each weight is 4.5" in diameter and labeled in lbs. and kg. Includes 1.1 lbs., 2.2 lbs., 3.3 lbs., 4.4 lbs., 5.5 lbs., and 6.6 lbs.

.....**61284** \$129.99 set



Exertools Soft Shell Exballs

Gel filled, pliable and textured for easy catching and use with the Plyback.

2 lbs.**61164** \$24.99 ea.
 4 lbs.**61165** \$39.99 ea.
 7 lbs.**61166** \$61.99 ea.
 11 lbs.**61167** \$69.99 ea.
 15 lbs.**61168** \$79.99 ea.



Cando Dual Hand Medicine Balls

- Ideal for abdominal training, rotational movement and strength training
- Dual, soft grip handle is easy to grip with one or two hands
- Perfect for core and torso exercises
- Handles enable wide ranges of movements

6 lbs., Yellow**62209** \$60.99 ea.
 12 lbs., Red**62210** \$71.99 ea.
 18 lbs., Green**62211** \$76.99 ea.
 24 lbs., Blue**62212** \$91.99 ea.
 30 lbs., Black**62213** \$106.99 ea.
 5-Piece Set**62214** \$349.99 set

Xtreme Monkey Medicine Ball Rebounder

Extra wide base for stability and weight distribution. Frame is made of heavy duty steel tubing with powder coat finish. Pop pin angle adjustment. Weighs 45 lbs. Some assembly required.

38"L x 38"W x 40"H**X16297-PS** \$249.99 ea.

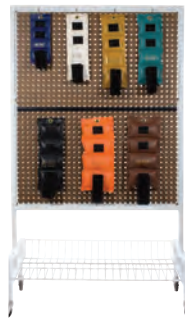

Cuff Weight by Elgin—Long Strap

Wrist/Ankle Exercise Weights come with attached long Velcro® straps and are color coded.

1 lb. 61050	\$16.99 ea.	4 lbs. 61267	\$20.99 ea.
2 lbs. 61052	\$17.99 ea.	5 lbs. 61055	\$23.99 ea.
2½ lbs. ... 61053	\$17.99 ea.	7½ lbs. ... 61056	\$33.99 ea.
3 lbs. 61054	\$19.99 ea.	10 lbs. 61057	\$39.99 ea.

Cuff Mobile Weight Rack

500 lbs. Capacity **1007577** \$319.99 ea.



Cando Vinyl-Coated Cast Iron Dumbbells

- Ideal for upper body exercises, physical therapy, weight training, and toning workouts
- Vinyl coating gives weight a comfortable feel
- Coated weight does not scratch floor
- Clearly marked in pounds and kilograms

1 lb., Pink 62228	\$3.49 ea.	7 lbs., Purple 62234	\$22.99 ea.
2 lbs., Violet.... 62229	\$6.99 ea.	8 lbs., Black 62235	\$25.99 ea.
3 lbs., Green ... 62230	\$9.99 ea.	9 lbs., Yellow ... 62236	\$29.99 ea.
4 lbs., Lt. Blue ... 62231	\$12.99 ea.	10 lbs., Orange .. 62237	\$32.99 ea.
5 lbs., Blue 62232	\$15.99 ea.	15 lbs., Silver.... 62238	\$49.99 ea.
6 lbs., Red. 62233	\$19.99 ea.	20 lbs., Brown... 62239	\$67.99 ea.

10 Piece Set

Includes 2 ea. 1-5 lbs.**62240** \$98.99 set
 Set with Dumbbell Wall Rack**62241** \$259.99 set

20 Piece Set

Includes 2 ea. 1-10 lbs.**62242** \$344.99 set
 Set with 2 Dumbbell Wall Racks.....**62243** \$454.99 set

Dumbbell Wall Rack

Holds 10 Dumbbells.....**62244** \$164.99 ea.

Dumbbell Floor Rack

Holds 10 pairs of Dumbbells**62245** \$136.99 ea.

Exercise Machines

NEW!



SciFit® Sport Upper Body Exerciser

The SciFit Sport Upper Body Exercisers are bi-directional exercisers to start exercising right away. The PRO1000 standard seat is removable for wheelchair access and has a fixed height that can adjust either forwards or backwards with a weight capacity for the standard seat of 500 lbs. The PRO1 does not have a seat included and standing is necessary in order to use this device.

PRO1000

61"L x 30"W x 62"H, 215 lbs. **1034727** \$4,500.00 ea.

PRO1

60"L x 30"W x 83"H, 234 lbs. **1034726** \$4,649.99 ea.



Circle Fitness E7e Elliptical

It's one thing to look good, it's another to feel good. The E7 elliptical is the perfect combination of brilliant design, contemporary styling, and comfort.

Features:

- Hybrid generator and dual-stage drive system provides optimal performance
 - Intuitive 16" LED or high definition touchscreen
 - Virtual Connect™ first person forward motion videos of beautiful sceneries
 - Contact and wireless heart-rate monitoring
 - Two-stage drive system, heavy-duty bearings, and over-sized shafts
 - Low side or rear entry step-on height with 20" natural stride and dual action handlebars deliver a total body workout
 - A variety of exercise programs and 25 resistance levels
 - Smooth Motion Technology™ with over-sized bearing delivers a quiet ride
- **.16320-PS** \$5,796.00 ea.



Spirit CE800 Elliptical Trainer

The CE800 was specifically engineered for the commercial environment, from its heavy-duty steel frame to its durable powder coat paint finish. Its design focuses on convenience, comfort, reliability, and aesthetic appeal.

Features:

- Smooth, quiet 20" stride
 - Dual rollers on each pedal arm for a sturdier base
 - Generator powered console (no need for electricity)
 - 40 levels of resistance
 - C-safe power and communication capabilities for A/V control
- **1007426** \$3,214.99 ea.



Spirit CT800 Treadmill

The CT800 is stout and extremely durable, weighing in at over 350 lbs. The combination of the heavy duty steel frame and aluminum console masts & side rails make it comparable to treadmills at much higher price points in the commercial market. The large workout area makes this model very appealing to walkers and runners.

Features:

- Bright, tri-color LED console
 - Quick speed and incline keys
 - C-safe power and communication capabilities for A/V control
 - Contact and wireless heart rate options
 - Maintenance free, hard wax deck system
 - 22"x 60" workout area
- **1007425** \$3,414.99 ea.



Spirit CU800 Upright Bike

The CU800 was specifically engineered for the commercial environment, from its heavy duty steel frame to its durable powder coat paint finish. The design focuses on convenience, comfort, and durability. The console offers multiple programs, most with 40 levels of resistance and enough feedback information to make sure your athletes never grow bored of the CU800. The extra-smooth ride comes from the perfect gearing and the integrated generator/flywheel system.

Features:

- Contact & telemetric heart rate capabilities
- Generator powered console (no need for electricity)
- Oversized foot pedals with fast latching system
- Dual spring seat with fore/aft adjustment
- 40 levels of resistance
- C-safe power and communication capabilities for A/V control

..... *1007419 \$2,114.99 ea.



Spirit CR800 Recumbent Bike

The CR800 Semi-Recumbent Bike is the perfect bike for the commercial environment. The step-thru design makes it easy for athletes to get on the bike, and the easy-adjust seat allows them to find the most comfortable position. The console offers multiple programs, most with 40 levels of resistance and enough feedback information to make sure your clients never grow bored of the CR800. The extra-smooth ride comes from the perfect gearing and the integrated generator/flywheel system.

Features:

- Contact & telemetric heart rate capabilities
- Generator powered console (no need for electricity)
- Oversized foot pedals with fast latching system
- High-density foam pads for extra comfort
- 40 levels of resistance
- C-safe power and communication capabilities for A/V control

..... *1007427 \$2,234.99 ea.

* Direct-ship item. Please allow additional time to receive.



Spirit CIC800 Indoor Cycle

The CIC800 Indoor Cycle excels in three critical areas—durability, comfort, and performance. The needle bearings that encompass the pedals and flywheel axle, industrial grade Hutchinson Poly-V belt, and three-piece crank work synergistically to create the perfect formula for durability and performance. The fore/aft/up/down adjustments of the handlebars and seat, along with SPD dual pedal design, provide a comfortable fit for nearly any size rider.

Features:

- Magnetic resistance for smooth and consistent, maintenance-free operation
- Micro fore/aft adjustments on seat and handlebars
- Reliable pop-pin up/down adjustments on seat and handlebars
- Molded rotary knob for comfortable resistance adjustments and quick-stop operation
- Dual-link pedals provide options for both SPD and toe-clip convenience
- Aluminum seat and handlebar posts with stamped height settings for quick reference

..... *1007428 \$1,599.99 ea.



Body Solid Endurance Fan Bike

Dual action and adjustable forward, back, and vertical.

- 27" steel resistance fan
- Weighs 97 lbs.
- 300 lbs. weight capacity

49"L x 24"W x 50"H

..... 16969-PS \$935.00 ea.



Chaimberg RXM AirBike

With USB port to up/download data!

- 24" resistance fan, silent belt drives
- Weighs 125 lbs.
- 350 lbs. weight capacity

60"L x 23.5" W x 48.5" H

..... 16976-PS \$990.00 ea.

NEW!



Body-Solid® R300 Endurance Rower

The R300 delivers an effective total body workout. An interactive console reports on time, heart rate, calories, paddle width, stroke rate, distance cycle, and more. Features eight preprogrammed exercises. Self-generating power, nickel-plated chain, and precision engineered flywheel. Separates for storage. Weight capacity: 330 lbs. Weighs 81.1 lbs. Warranty: 15 yr. frame, 3 yr. parts, 2 yr. electronics, 1 yr. labor, 6 month wear parts.

95.1"L x 24.4"W x 39.8"H

..... 29573-PS \$889.99 ea.

SPORTS™ HEALTH

Building A Healthier You



PAGE
143

PAGE
143



PAGE
152

PAGE
168



Strength & Conditioning



Medicine Balls	152-154	Battle Rope.....	175
Weighted Bars.....	154	Hurdles.....	176-177
Weighted Vests/Sandbags.....	155	Bars & Collars.....	178
Handweights	156-157	Olympic Plates.....	179
Weights.....	158	Weight Lifting	180-181
Kettlebells.....	159	Flooring.....	182
Suspension Training	160-161	Boxing.....	183
Bodyweight Training.....	162-163	Steps	184
Core.....	164	Timers.....	185
Jump Ropes	165	Circuit Stations	186-189
Stability Balls	166	Mats.....	190-191
Plyometrics.....	167	Yoga.....	192-193
Agility	168-173	Assessment	194-195
Obstacle Course	174	Audio.....	196

Medicine Balls



Sports Health™ Rubber Medicine Balls

One piece sturdy rubber construction has a textured surface for enhanced grip. Shape and bounce are maintained via a rubber valve.

4 lbs. Orange.....	X29559-PS	\$17.97 ea.
6 lbs. Blue.....	X29560-PS	\$24.97 ea.
8 lbs. Red.....	X29561-PS	\$28.97 ea.
10 lbs. Black.....	X29562-PS	\$31.97 ea.
12 lbs. Purple.....	X29563-PS	\$39.97 ea.
Set of 5 one of Each: 4 lbs., 6 lbs., 8 lbs., 10 lbs., and 12 lbs.	X29569-PS	\$139.97 set



Xtreme Monkey Pro Slam Balls

Textured, thick rubber designed for excellent grip. Features a dead bounce and won't roll away. Diameter: 4–20lbs.—12" and 25–50lbs.—15".

4 lbs.	X16903-PS	\$19.99 ea.	20 lbs. . .	X53498-PS	\$40.99 ea.
6 lbs.	X16904-PS	\$25.99 ea.	25 lbs. . .	X53499-PS	\$49.99 ea.
8 lbs.	X16905-PS	\$29.99 ea.	30 lbs. . .	X53956-PS	\$60.99 ea.
10 lbs.	X53496-PS	\$27.99 ea.	35 lbs. . .	X16907-PS	\$72.99 ea.
12 lbs.	X16906-PS	\$29.99 ea.	40 lbs. . .	X53957-PS	\$80.99 ea.
15 lbs.	X53497-PS	\$32.50 ea.	50 lbs. . .	X53959-PS	\$82.50 ea.

Ball Packs

Low Weight 8 Ball Pack- 2 of each: 4 lb., 6 lb., 8 lb. & 10 lb.

..... **X16908-PS** \$194.99 pk.

Medium Weight 4 Ball Pack- 1 of each: 10 lb., 12 lb., 15 lb. & 20 lb.

..... **X16909-PS** \$124.99 pk.

Heavy Weight 4 Ball Pack- 1 of each: 25 lb., 30 lb., 35 lb. & 40 lb.

..... **X16910-PS** \$269.99 pk.



Element Fitness Commercial Medicine Balls

Durable PVC rubber construction with textured surface for maximum grip and control. Ideal ball to combine strength training, cardio, flexibility and dynamic muscle training.

4 lbs. 6.5" dia.	X16890-PS	\$25.50 ea.
6 lbs. 9" dia.	X16891-PS	\$31.50 ea.
8 lbs. 9" dia.	X16892-PS	\$36.99 ea.
10 lbs. 9" dia.	X16893-PS	\$43.99 ea.
12 lbs. 9" dia.	X16894-PS	\$55.99 ea.
Light Pack-2 of each: 4 lb., 6 lb. & 8 lb. . . .	X16900-PS	\$174.99 pk.
Medium Pack-2 of each: 10, 12, & 16 lb. . .	X16901-PS	\$329.99 pk.
Heavy Pack-2 of each: 20, 25, & 30 lb. . . .	X16902-PS	\$699.99 pk.

Element Fitness Combo Ball Packs with Rack

Both racks are commercial quality, constructed of steel with a corner design for smaller imprint.

10 Ball Combo Pack

Includes: One of each Commercial Balls: 4 lb., 6 lb., 8 lb., 10 lb. & 12 lb. and 10 lb., 15 lb., 20 lb., 25 lb. & 30 lb. Pro Slam balls and 10 Ball Rack.

..... **X16911-PS** \$569.99 pk

Rack only **16913-PS** \$199.99 ea.

15 Ball Combo Pack

Includes: One of each Commercial Balls: 4 lb., 6 lb., 8 lb., 10 lb., 12 lb., 16 lb., 20 lb. & 30 lb. and 6 lb., 8 lb., 10 lb., 12 lb., 15 lb., 20 lb. & 25 lb. Pro Slam balls and 15 Ball Rack.

..... **16912-PS** \$949.99 pk.

Rack only **16914-PS** \$283.99 ea.





Rhino ProMax Fitness Balls

Constructed with a soft outer layer for a great feel yet strong enough to withstand high velocity impact. Designed to maintain a balanced weight and remain stable. 14" Diameter.

4 lbs. Red	X53315-PS	\$27.99 ea.
6 lbs. Orange . . .	X53316-PS	\$32.99 ea.
8 lbs. Yellow . . .	X53317-PS	\$33.99 ea.
10 lbs. Green . . .	X53318-PS	\$34.99 ea.
12 lbs. Blue	X53319-PS	\$35.99 ea.
14 lbs. Lt. Blue . .	X53320-PS	\$41.99 ea.
16 lbs. Purple . . .	X53321-PS	\$44.99 ea.
18 lbs. Brown . . .	X53322-PS	\$47.99 ea.
20 lbs. Black . . .	X53323-PS	\$52.99 ea.



ProMax Medicine Ball Class Pack

Rack is constructed of steel and has a U shape base for stability. Holds 8 oversized medicine balls. Class Pack includes one of each 4, 6, 8, 10, 12, 14, 16, and 20 lb. medicine balls and medicine ball rack. Ships by truck

Pack; 8 Medicine Balls and	T66544-PS	\$499.97 pk.
Medicine Ball Rack only	X54194-PS	\$209.97 ea.



Rhino Leather Medicine Balls

These hand sewn heavy duty leather covered balls with weighted filler will help you continue this basic and simple workout.

4-5 lbs.; 9.4" dia. Red	X25024-PS	\$17.99 ea.
6-7 lbs.; 24.5" dia. Yellow	X25025-PS	\$19.99 ea.
9-10 lbs.; 24.5" dia. Blue	X25026-PS	\$22.99 ea.
11 lbs.; 25" dia. Orange	X25027-PS	\$26.99 ea.
14-15 lbs.; 26.3" dia. Green	X25028-PS	\$29.99 ea.

Rhino Leather Medicine Ball Pack

Five ball medicine ball pack includes one of each: 4-5, 6-7, 10, 11 and 14 lb. balls. Optional Ball rack (#25114) available on next page.

.	X16244-PS	\$109.67 pk.
-----------	------------------	--------------



Xtreme Monkey Wall Balls

Designed to allow the athlete to increase the weight without changing their movement. These med balls have a more "solid" feel compared to other balls on the market. Balanced, easy to grip and can take a tough workout. Cover is constructed of a doubled stitch PVC for durability. Not designed for slamming exercises. 14" diameter.

8 lbs.16246-PS	\$59.99 ea.
10 lbs.16247-PS	\$63.99 ea.
14 lbs.16248-PS	\$72.99 ea.
20 lbs.16249-PS	\$89.99 ea.



Rhino Gel Filled Medicine Balls

Built to withstand tough workouts- roto molded vinyl shells absorb impact and retain shape quickly. Will not split or leak. Textured grip for easy catching drills.

4 lbs.; 6" dia. Blue	X52917-PS	\$13.99 ea.
7 lbs.; 7" dia. Green	X52918-PS	\$17.99 ea.
11 lbs.; 8.5" dia. Purple	X52919-PS	\$27.99 ea.
15 lbs; 10" dia. Orange	X52920-PS	\$34.99 ea.



Medicine Balls/Weighted Bars

NEW!



Smart Medicine Balls with Rack

The weighted center forces the user to use different muscle groups to throw, bounce or twist with the ball. Textured surface for a reliable grip and made of sturdy rubber. Rack features space saving wall-mount design and heavy duty steel construction. Measures 9"W x 11"D x 43"H. Includes 4 balls: 4, 6, 8 and 10 lbs.

4-Ball Set with Rack29570-PS	\$348.99 pk.
Wall Rack (only)29571-PS	\$159.00 ea.



Medicine Ball Racks

Racks feature easy access tilt design, heavy duty steel tube construction and powder coat finish. Upright Rack has swivel casters for transport. Some assembly required on racks. Balls sold separately.

A. 12 Ball Rack-Measures 28"L x 44"W x 40"H; weighs 30 lbs.	X25130-PS	\$169.99 ea.
B. 15 Ball Rack- Measures 53"L x 9.5"W x 35"H; weighs 31 lbs.	X53174-PS	\$199.99 ea.
C. 5 Ball Rack- Measures 14"L x 11"W x 52"H	X25114-PS	\$71.99 ea.
D. 10 Ball Rack- Measures 22.5"L x 11"W x 52"H	X25115-PS	\$75.99 ea.
E. 20 Ball Rack- Measures 25"L x 25"W x 56"H	X25128-PS	\$229.99 ea.

Body Bar Weighted Bars

User friendly and versatile, features foam rubber grip with a solid steel construction and rubber end caps. Color coded by weight. Sold individually. Storage rack sold separately. 48" long.

3 lbs. Teal	X54297-PS	\$26.99 ea.
4 lbs. Red:	X54298-PS	\$29.99 ea.
6 lbs. Orange	X54299-PS	\$31.99 ea.
9 lbs. Pink	X54300-PS	\$35.99 ea.
12 lbs. Blue:	X54301-PS	\$44.99 ea.
15 lbs. Green	X54302-PS	\$49.99 ea.
18 lbs. Yellow	X54303-PS	\$59.99 ea.
24 lbs. Black	X54304-PS	\$79.99 ea.

12 and 24 Packs

12 Bar Low Wt. - 4 each: 4 lb., 6 lb., & 9 lb. bars	X66762-PS	\$359.99 pk.
24 Bar Low Wt. - 8 each: 4 lb., 6 lb., & 9 lb. bars	X66763-PS	\$699.99 pk.
12 Bar Med Wt. - 4 each: 12 lb., 15 lb., & 18 lb. bars	X66764-PS	\$575.99 pk.
24 Bar Med Wt. - 8 each: 12 lb., 15 lb., & 18 lb. bars	X66765-PS	\$1,099.99 pk.



Body Bar Storage Rack

Space saving design keeps all of your bars organized. 25"W x 39"H x 18"D; weighs 40 lbs. . . . **X54308-PS** \$149.99 ea.

Weighted Vests/Sandbags

Xtreme Monkey

Adjustable Weight Vest

Weight is evenly distributed throughout the vest for comfort and balance. Made from strong nylon with adjustable Velcro® straps for the perfect fit. Vest includes incremental weights that won't fall free from the pockets.

25 lbs.	16282-PS	\$138.99 ea.
35 lbs.	16283-PS	\$143.99 ea.
45 lbs.	16284-PS	\$149.99 ea.
55 lbs.	16285-PS	\$179.99 ea.



Body Solid Weighted Vest

Even weight pockets result in optimal center of gravity without restricting movement. Increase or decrease load with 1 lb. weight rods.

20 lbs.	X16920-PS	\$83.99 ea.
40 lbs.	X16921-PS	\$91.99 ea.



Xtreme Monkey Tornado Bag

Fits most standard rubber medicine balls. Made from a thick vinyl with reinforced seams, nylon strapping and a 30" long rope.

.....	16293-PS	\$39.99 ea.
-------	-----------------	-------------



Surge® Storm Fluid Resistance Trainer

Choose the full-size Storm, or the compact Riptide – utilize water to create an unstable/unpredictable resistance workout and challenge muscles. Over 50 innovative movement patterns. Vertical, horizontal, and exterior grip options. Storm: 9 – 60.5 lbs. (filled). Riptide: 7.5 – 38 lbs. (filled).

42"L x 8.5"D Storm Orange.....	54317-PS	\$179.95 ea.
33.25"L x 8.5"D Riptide Green.....	54318-PS	\$109.95 ea.



Xtreme Monkey Commercial Sandbags

Made from heavy duty tactical nylon with multiple handles for a variety of grips. Includes two interior filler bags made from tough PVC with secure closures. Sandbags not designed for slams. Sand not Included.

20 lbs., 32"L x 13"	16294-PS	\$79.99 ea.
50 lbs., 27"L x 10"	16295-PS	\$99.99 ea.
80 lbs., 32"L x 13"	16296-PS	\$130.50 ea.
3 Pack: one of each	16915-PS	\$319.99 pk.



Vulcan Sand Bag

Constructed from 1050 denier ballistic nylon with heavy duty parachute grade stitching, button enclosures and zipper. Includes three pouches—a 22"L x 8"W medium pouch holding up to 20 lbs. and two larger 33"L x 9"W pouches holding up 40 lbs. each. Peat gravel is recommended filler as it leaves the bag more pliable than traditional sand. Filler not included.

36"L x 12"	16731-PS	\$79.99 ea.
3 Pack.....	16916-PS	\$217.99 pk.



SKLZ Super Sandbag

Includes four heavy duty vinyl weight bags that hold up to 10 lbs. of sand per bag. Removable weight bags can be used as soft weights separately. Maximum capacity for entire bag is 40 lbs. Sand not included.

.....	53375-PS	\$53.99 ea.
3 Pack	16917-PS	\$143.99 pk.

Ankle/Wrist Weights

Soft neoprene cover with an adjustable Velcro® closure for a friction free, comfortable fit.

1 lb. each (2 lb. pr)	X52271-PS	\$9.99 pr.
2.5 lb. each (5 lb. pr)	X52272-PS	\$15.99 pr.
5 lb. each (10 lb. pr)	X52273-PS	\$19.99 pr.



Handweights



Neoprene Hex Dumbbells

Dumbbells and rack sold individually or Pack is available. Rack has locking bar, swivel casters and holds up to 500 lbs. Made from powder coated steel and measures Ships by Truck. Colors many vary.

37.5"L x 16"W x 42.25"H

1 lb. Pink.....	X52649-PS	\$2.25 ea.
2 lbs. Dk. Pink.....	X52650-PS	\$4.50 ea.
3 lbs. Lime.....	X52651-PS	\$6.75 ea.
4 lbs. Lt. Blue.....	X52652-PS	\$9.00 ea.
5 lbs. Dk. Blue.....	X52653-PS	\$11.25 ea.
6 lbs. Green.....	X52654-PS	\$13.50 ea.
7 lbs. Purple.....	X52655-PS	\$15.75 ea.
8 lbs. Red.....	X52656-PS	\$18.00 ea.
9 lbs. Black.....	X52657-PS	\$20.25 ea.
10 lbs. Gray.....	X52658-PS	\$22.50 ea.
Dumbbell Rack 61 lbs.....	T52659-PS	\$449.99 ea.

Pack Includes:

16-1 lb., 12-2 lb., 10-3 lb., 10-4 lb., 9-5 lb., 8-6 lb., 8-7 lb., 8-8 lb., 7-9 lb., 7-10 lb. dumbbells and rack. Total weight 456 lbs.

.....	T52660-PS	\$989.99 pk.
-------	------------------	--------------

Troy Soft Vinyl Iron Hand Weights

Dumbbells and Stackable Rack are sold individually. The Stackable Rack is constructed of heavy gauge steel with a locking mechanism at the top. Aerobic Pack includes the Rack and 43 pairs of assorted weight dumbbells. Casters can be purchased separately to convert rack to a mobile unit. Ships by Truck.

1 lb. Dk. Pink.....	X52051-PS	\$1.99 ea.
2 lbs. Purple.....	X52052-PS	\$3.99 ea.
3 lbs. Green.....	X52053-PS	\$5.99 ea.
4 lbs. Lt. Purple.....	X52054-PS	\$7.99 ea.
5 lbs. Dk. Blue.....	X52055-PS	\$9.99 ea.
6 lbs. Red.....	X52002-PS	\$11.75 ea.
7 lbs. Dk. Purple.....	X52056-PS	\$13.75 ea.
8 lbs. Black.....	X52003-PS	\$15.75 ea.
9 lbs. Yellow.....	X52004-PS	\$17.50 ea.
10 lbs. Orange.....	X52057-PS	\$18.99 ea.
Pack-Includes rack & 43 pairs of weights.	T52061-PS	\$1,019.99 pk.
Stackable rack only (no casters).....	T52060-PS	\$399.99 ea.
Casters for Rack set of 4.....	X52067-PS	\$76.99 set
Under Rack.....	X52071-PS	\$102.99 ea.



Cando® Vinyl Coated Dumbbell Packs

Coated weight does not scratch floors. Feels comfortable in the hand. Racks are wall mounted and hold up to 10 dumbbells.

3"W x 48"H x 3"D, 23 lbs.

10-Dumbbell Pack - 2 each: 1 - 5 lbs.....	.62240	\$98.99 pk.
20-Dumbbell Pack - 2 each: 1 - 10 lbs.....	.62242	\$344.99 pk.
10 Pack with Wall Rack.....	.62241	\$259.99 pk.
20 Pack with Two Wall Racks.....	.62243	\$454.99 pk.
Floor rack holds 10 pairs of dumbbells (not included)		
20"L x 20"W x 28"H.....	.62245	\$136.99 ea.

Element Fitness Colored Aerobic Hex Dumbbell Set

Rubber encased dumbbells with contoured chrome knurled handles. Sold as a set: one pair of each weight 2 lbs. through 12 lbs.; 2 lb. Indigo, 3 lb. Green, 4 lb. Sky Blue, 5 lb. Royal Blue, 6 lb. Red, 7 lb. Purple, 8 lb. Black, 9 lb. Yellow, 10 lb. Orange, 12 lb. Purple. Available as a pack with rack. Ships by Truck.

Aerobic Hex Dumbbell Set.....	T17149-PS	\$442.99 set
Aerobic Hex Dumbbell Set with Rack ...	T17150-PS	\$519.99 ea.
Rack only.....	X16729-PS	\$115.99 ea.

Troy Solid Hex Dumbbells

Hammertone finish with knurled handle for secure grip.

3 lbs.	X53304-PS	\$4.50 ea.
5 lbs.	X52698-PS	\$7.25 ea.
10 lbs.	X52699-PS	\$14.25 ea.
15 lbs.	X52700-PS	\$24.99 ea.
20 lbs.	X52701-PS	\$31.99 ea.
25 lbs.	X52702-PS	\$38.99 ea.
30 lbs.	X52703-PS	\$44.99 ea.
35 lbs.	X52704-PS	\$56.99 ea.
40 lbs.	X52705-PS	\$62.99 ea.
45 lbs.	X52706-PS	\$73.99 ea.
50 lbs.	X52707-PS	\$78.99 ea.



York Barbell Rubber Hex Dumbbells

Permanently attached with solid steel, chrome plated, knurled handle.

3 lbs.	X53305-PS	\$7.99 ea.
5 lbs.	X52672-PS	\$10.99 ea.
10 lbs.	X52673-PS	\$16.99 ea.
15 lbs.	X52674-PS	\$24.99 ea.
20 lbs.	X52675-PS	\$33.99 ea.
25 lbs.	X52676-PS	\$39.99 ea.
30 lbs.	X52677-PS	\$48.99 ea.
35 lbs.	X52678-PS	\$54.99 ea.
40 lbs.	X52679-PS	\$63.99 ea.
45 lbs.	X52680-PS	\$69.99 ea.
50 lbs.	X52681-PS	\$77.99 ea.



Dumbbell Station Pack with Rack

Rack is constructed of 11 gauge steel measuring 2" x 3" with powder coat finish and high impact polyethylene cradles to adjust each level to fit your needs. Available in gray only, Ships by Truck.

Troy Solid Hex Station Packs

Low Weight Pk- 5 ea.- 3, 5 & 10 lb dumbbells & rack	X53307-PS	\$599.99 pk.
Medium Weight Pk- 5 ea.- 5, 10 & 15 lb dumbbells & rack	T53308-PS	\$699.99 pk.
Heavy Weight Pk- 5 ea.- 20, 25 & 30 lb dumbbells & rack	T53309-PS	\$949.99 pk.
Dumbbell Rack only- measures 70"L x 36"H x 24"D	X53306-PS	\$419.99 ea.

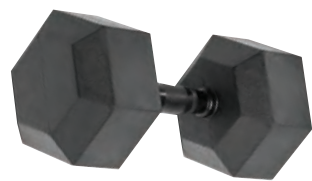

Element Fitness Commercial Hex Dumbbells

Ergonomic knurled handle reduces fatigue and maximizes comfort. Commercial rack measures 38"H x 56"W x 34"D and holds 13 pair of dumbbells.

3 lbs.	X16930-PS	\$5.69 ea.
5 lbs.	X16931-PS	\$9.49 ea.
8 lbs.	X16932-PS	\$14.99 ea.
10 lbs.	X16933-PS	\$18.99 ea.
12 lbs.	X16934-PS	\$25.50 ea.
15 lbs.	X16935-PS	\$31.99 ea.
20 lbs.	X16936-PS	\$42.50 ea.
25 lbs.	X16937-PS	\$52.99 ea.
30 lbs.	X16938-PS	\$63.99 ea.
35 lbs.	X16939-PS	\$74.99 ea.
40 lbs.	X16940-PS	\$84.99 ea.
45 lbs.	X16941-PS	\$94.99 ea.
50 lbs.	X16942-PS	\$97.99 ea.
Complete Weight Pack- 2 of each: 5-50 lbs. & Rack: Ships by Truck.	.16943-PS	\$1,699.99 pk.
3 Tier Rack only	.16944-PS	\$699.99 ea.

York Barbell Rubber Hex Packs

Low Weight: 2 of each: 3, 5, 10, 15 & 20 lb dumbbells & rack	X16608-PS	\$562.99 pk.
Medium Weight : 2 of each: 10, 15, 20, 25 & 30 lb dumbbells & rack	T16609-PS	\$673.99 pk.
Heavy Weight: 2 of each: 30, 35, 40, 45 & 50 lb dumbbells & rack	T16610-PS	\$857.99 pk.
Dumbbell Rack only- measures 70"L x 36"H x 24"D	X53306-PS	\$419.99 ea.



Vulcan Hex Rubber Dumbbell Sets

Vulcan Rubber Compounds and Knurling Pattern Provide a Less Slippery Grip than Chrome plated handles. Rack measures 56"L x 35"H x 18"W; weighs 125 lbs. All packs ship by truck.

5 lbs.	X16701-PS	\$24.99 ea.
10 lbs.	X16702-PS	\$43.99 ea.
15 lbs.	X16703-PS	\$53.99 ea.
20 lbs.	X16704-PS	\$69.99 ea.
25 lbs.	X16705-PS	\$81.99 ea.
30 lbs.	X16706-PS	\$99.99 ea.
35 lbs.	X16707-PS	\$129.99 ea.
40 lbs.	X16708-PS	\$149.99 ea.
45 lbs.	X16709-PS	\$169.99 ea.
50 lbs.	X16710-PS	\$189.99 ea.
Low Weight Pack- 2 of each: 5, 10, 15, 20 & 25 lbs. & Rack	T16711-PS	\$418.99 pk.
Heavy Weight Pack- 2 of each: 30, 35, 40, 45 & 50 lbs. Rack	T16712-PS	\$756.99 pk.
Complete Weight Pack- 2 of each: 5-50lbs & Rack	T16713-PS	\$876.99 pk.
Rack only	T16714-PS	\$299.00 pk.



Weights



York Barbell Pro Style Fixed Fixed Straight & Curl Bars

The barbell heads are comprised of solid steel inserts fully encased in rubber. The solid steel handle passes through the steel insert and is welded permanently joining the head to the bar. Rack is made from bent steel tubing and holds 10 bars; measures 34"W x 33.5"D x 66"H. Sets consist of 10 bars, one of each in each weight available. All sets ship by truck.

Fixed Straight Barbells

20 lbs.....	X16670-PS	\$62.99 ea.
30 lbs.....	X16671-PS	\$89.99 ea.
40 lbs.....	X16672-PS	\$119.99 ea.
50 lbs.....	X16673-PS	\$146.99 ea.
60 lbs.....	X16674-PS	\$174.99 ea.
70 lbs.....	X16675-PS	\$199.99 ea.
80 lbs.....	X16676-PS	\$237.99 ea.
90 lbs.....	X16677-PS	\$265.99 ea.
100 lbs.....	X16678-PS	\$289.99 ea.
110 lbs.....	X16679-PS	\$317.99 ea.
Fixed Straight Bar Set	T16658-PS	\$1,749.99 set
Fixed Straight Bar Set with Rack	T16660-PS	\$2,049.99 set

Fixed Curl Barbells

20 lbs.....	X16680-PS	\$62.99 ea.
30 lbs.....	X16681-PS	\$89.99 ea.
40 lbs.....	X16682-PS	\$119.99 ea.
50 lbs.....	X16683-PS	\$146.99 ea.
60 lbs.....	X16684-PS	\$174.99 ea.
70 lbs.....	X16685-PS	\$199.99 ea.
80 lbs.....	X16686-PS	\$237.99 ea.
90 lbs.....	X16687-PS	\$265.99 ea.
100 lbs.....	X16688-PS	\$289.99 ea.
110 lbs.....	X16689-PS	\$317.99 ea.
Fixed Curl Bar Set	T16659-PS	\$1,749.99 set
Fixed Curl Bar Set with Rack	T16661-PS	\$2,049.99 set
Barbell Rack only	T16662-PS	\$389.99 ea.

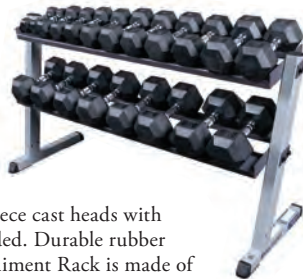

Body-Solid® Pro Dumbbell Pack with 2 Tier Rack

Secure Dumbbell System combines one-piece cast heads with steel inserts, pinned, press fitted, and welded. Durable rubber coating prevents damage to floors and equipment Rack is made of heavy gauge steel.

Pack, two of each: 5-50 lbs. & Rack.....	T54334-PS	\$1,049.99 pk.
2-Tier Rack only: 23"L x 62"W x 32"H....	X54296-PS	\$274.99 ea.



Body-Solid® 3-Tier Dumbbell Rack

Secure Dumbbell System combines one-piece cast heads with steel inserts, pinned, press fitted, and welded. Durable rubber coating prevents damage to floors and equime Rack is made of heavy gauge steel.

Pack: 2 of each: 5-50 lbs. & Rack.....	T54335-PS	\$999.99 pk.
3-Tier Rack only: 40"L x 20"W x 30"H. . .	X54295-PS	\$175.99 ea.



SandBells®

Thick neoprene is soft and stretchy to the touch, but also durable enough to be pulled, yanked and abused daily. SandBells are pre filled with sand.

Light Mini Pack, two of each: 2 lb., 4 lb., and 6 lb. Filled Light Pack	X66500-PS	\$119.99 pk.
Heavy Mini Pack, two of each: 6 lb., 8 lb., and 10 lb. Filled Heavy Pack	X66600-PS	\$174.99 pk.
Mega Pack includes (2) 2 lb., (4) 4 lb., (4) 6 lb., (4) 8 lb., and (2) 10 lb. Filled SandBell Mega Pack	X66579-PS	\$348.99 pk.
Storage Rack 57.25"H x 18.75"W.....	X29572-PS	\$99.99 ea.



SoftBell® Dumbbell KettleBell Combo Set

Innovative design combines an extremely durable, neoprene case with a sand fill to create a versatile and safer alternative dumbbells & kettlebells. SoftBell® plates are interchangeable to suit a variety of workouts. Sets include: 12 plates (full set includes 24), one kettlebell handle, two dumbbell handles, four short bolts and five long bolts (use to add multiple plates).

Light Set, four each of 1.5 lb., 3 lb., and 4.5 lb.	X66770-PS	\$244.99 set
Heavy Set, four each of 6 lb., 7.5 lb., and 10 lb.	X66771-PS	\$275.99 set
Full Set, four each of 1.5 lb., 3 lb., 4.5 lb., 6 lb., 7.5 lb., and 10 lb.	X66772-PS	\$339.99 set

Cando Vinyl Kettlebells

Vinyl coated Cast iron to reduce noise and protect floors. Deluxe pack includes rack X53503-PS and ships by truck.

Yellow: 5 lbs.	X54233-PS	\$18.39 ea.
Red: 7.5 lbs.	X54234-PS	\$22.39 ea.
Green: 10 lbs.	X52810-PS	\$23.99 ea.
Royal: 15 lbs.	X52811-PS	\$32.99 ea.
Black: 20 lbs.	X52813-PS	\$43.99 ea.
Silver: 25 lbs.	X52814-PS	\$52.99 ea.
Gold: 30 lbs.	X52815-PS	\$59.99 ea.
Essential 5 Pack – 1 each: 5, 7.5, 10, 15 & 20 lbs.	X62207	\$171.00 pk.
Medium 6 Pack- 2 each: 10, 15, & 20 lb.	X54120-PS	\$194.97 pk.
Heavy 6 Pack- 2 each: 20, 25, & 30 lb.	T54121-PS	\$302.97 pk.
Deluxe Pack- 2 each: 10, 15, 20, 25, & 30 lb. & rack	T54122-PS	\$519.97 pk.



York Iron Kettlebells

Kettlebells are made from cast iron and are perfect for strength training, muscle coordination and aerobic exercise. Mega and deluxe packs include rack X53503-PS and ships by truck.

10 lbs.	X52661-PS	\$18.99 ea.
15 lbs.	X52662-PS	\$27.99 ea.
20 lbs.	X25813-PS	\$35.99 ea.
25 lbs.	X52663-PS	\$45.99 ea.
30 lbs.	X25814-PS	\$52.99 ea.
35 lbs.	X52664-PS	\$60.99 ea.
Medium Pack, two each: 10, 15, & 20 lb	X29569-PS	\$139.97 pk.
Heavy Pack, two each: 25, 30, & 35 lb.	X54124-PS	\$289.97 pk.
Deluxe Pack, two each: 10,15, 20, 25, 30 lb. & rack	T54125-PS	\$539.97 pk.
Mega Pack, two each: 10, 15, 20 lb. & 1 each: 25, 30, 35, 40, 45, 50, 60, 70 lb. & rack	T52670-PS	\$749.97 pk.



NEW!

Cando Kettlebell Storage Rack

Durable iron rack securely holds kettlebells for easy access during training. Two-tier shelving. 660 lbs. capacity. Weighs 60 lbs.

47"W x 32"H x 26"D	62208	\$350.00 ea.
------------------------------	--------------	--------------



Body-Solid Premium Kettlebell

Featuring a chrome handle and a dipped rubber base. Handles on the heavier weights are large enough to accommodate both hands. Deluxe packs include rack X53503-PS and ships by truck.

5 lbs.	X54250-PS	\$11.99 ea.
10 lbs.	X54251-PS	\$21.99 ea.
15 lbs.	X54252-PS	\$32.99 ea.
20 lbs.	X54253-PS	\$43.99 ea.
25 lbs.	X54254-PS	\$54.99 ea.
30 lbs.	X54255-PS	\$65.99 ea.
35 lbs.	X54256-PS	\$75.99 ea.
40 lbs.	X54257-PS	\$86.99 ea.
45 lbs.	X54258-PS	\$97.99 ea.
50 lbs.	X54259-PS	\$108.99 ea.
Medium 6 Pack- 2 each: 5, 10 & 15 lb.	X54244-PS	\$114.97 pk.
Heavy 6 Pack- 2 each: 20, 25 & 30 lb.	X54245-PS	\$295.97 pk.
Deluxe Med. 10 Pack- 2 each: 5, 10, 15, 20 & 25 lb & Rack	T54246-PS	\$459.97 pk.
Deluxe Heavy 10 Pack- 2 each: 30, 35, 40, 45 & 50 lb & Rack	T54247-PS	\$849.97 pk.



Rhino 6" Kettlebells

Made from a latex-free material with an ABS handle. Not intended for bouncing or throwing exercises. Deluxe packs include rack X53503-PS.

5 lbs. Purple.	X53506-PS	\$34.99 ea.
6 lbs. Yellow.	X53507-PS	\$38.99 ea.
7 lbs. Teal.	X53508-PS	\$46.99 ea.
8 lbs. Green.	X53509-PS	\$50.99 ea.
6" Medium 6 Pack, two each: 6, 7, & 8 lb.	X54117-PS	\$259.99 pk.
6" Deluxe Pack, two each: 3, 4, 5, 6, 7, & 8 lb. & rack	X53534-PS	\$629.99 pk.

Kettlebell Rack

Stores up to 12 of the 8" diameter Kettlebells. Made from steel with a powdercoat finish. Rubber-lined shelves reduce noise. Easy assembly. Kettlebells not included.

22"L x 45¼"W x 30"H.	X53503-PS	\$269.99 ea.
------------------------------	------------------	--------------



Suspension Training



Lebert Equalizer

Offers hundreds of exercise options with easy to modify exercises to suit the needs of all users. Safe, lightweight and easy to store. Steel construction with powder coat finish. Measures 28.5"H x 25"W; weighs 8 lbs. per bar. Weight capacity of 400 lbs. Sold as a pair.

Lime	X53905-PS	\$109.99 pr.
Pink	X53947-PS	\$109.99 pr.
Yellow	X53286-PS	\$109.99 pr.



Xtreme Monkey Paralettes

Steel construction with sturdy bases for explosive swing throughs or weighted handstand pushups. Sold as a pair.

24"L x 13"H	X16926-PS	\$80.99 pr.
-------------------	------------------	-------------



PowRIT Wall Mount Dip Station

Features 6" long x 1.25" diameter hand grips and supports up to 500 lbs. Handles extend 17" from wall. Mount on 16" center studs. Unit measures 23" long. Includes mounting hardware.

.....	.16600-PS	\$99.97 ea.
-------	------------------	-------------



Sports Health™ Suspension Trainer

Build functional core strength and increase range of motion. Target legs, back, chest, arms and shoulders. Made with heavy grade 1.5" web strapping; easy to adjust low profile cam buckles, padded handles with foot loops and door mount. Compared to other brands, this one exceeds in quality. Includes carry bag.

Sports Health Suspension Trainer54198-PS	\$47.97 ea.
3 Pack16253-PS	\$142.97 ea.
6 Pack16254-PS	\$286.97 ea.

VULCAN Pegboard

Maple wood board with stainless steel end protector plates. The board features 35 staggered holes and can be mounted vertically or horizontally. Includes 2 pegs and mounting hardware. Weighs 42 lbs.

95.5"L x 11.75"W x 1.5" thick	X16947-PS	\$328.00 ea.
-------------------------------------	------------------	--------------

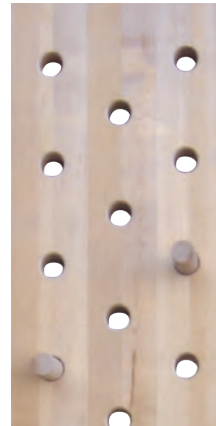

Peg Board Climbers

Mount singly, in blocks, or as many as you wish. Arrange them in any shape or pattern. Handmade and hand finished, triple coated varnish with machine drilled holes. Two size boards; 6'L x 6"W & 1.5" thick or 6'L x 12"W & 1.5" thick. Each board comes with one pair of pegs. Mounting kit for concrete or brick is additional.

29 holes 6' x 6"	X28012-PS	\$179.99 ea.
38 holes 6' x 12"	X28016-PS	\$299.99 ea.
Mt. Kit for 6' x 6"	X28018-PS	\$72.99 ea.
Mt. Kit for 6' x 12"	X28019-PS	\$77.99 ea.
Extra Pegs28094-PS	\$11.99 pr.

NEW!



TRX® Sweat System

Updated from top to bottom with adjustable foot cradles, padded foam handles and pinstripe webbing for greater comfort, functionality and durability. Also includes: Door & suspension anchors, mesh bag, poster & 6 month TRX app subscription plus six video workouts. Weight: 1.5 lbs.

Single.....	17381-PS	\$179.95 ea.
3 Pack.....	17382-PS	\$539.85 pk.
6 Pack.....	17383-PS	\$1,079.70 pk.



TRX® Commercial Suspension Trainer

Constructed of commercial-grade materials, and built heavy use. Comes textured, ergonomic rubber handles, padded foot cradles and a locking carabiner. Also includes an extender strap higher anchor points. Weight: 2 lbs.

Single.....	16082-PS	\$209.95 ea.
Trainer 3 Pack	16083-PS	\$629.85 pk.
Trainer 6 Pack	16084-PS	\$1,259.70 pk.



Xtreme Monkey Gym Rings

Made from tough ABS plastic, the rings are attached to 1" wide nylon webbing that is 14' long. Easy to adjust and mount to overhead fixtures. Maximum weight capacity is 350 lbs.

.....	16289-PS	\$69.99 set
-------	-----------------	-------------



TRX® Pro Suspension Trainer

Designed for the heavy use, TRX Pro has textured rubber handles, upgraded webbing, adjustable and padded foot cradles, and a locking carabiner. Also includes: Extender strap, door & suspension anchors, mesh bag & 1 year TRX app subscription. Weight: 2 lbs.

Single.....	17378-PS	\$249.95 ea.
3 Pack	17379-PS	\$749.85 pk.
6 Pack	17380-PS	\$1,499.70 pk.
X-Mount -Measures 4.5".....	16085-PS	\$39.95 ea.



TRX® MultiMount

Sturdy, industrial-grade steel, wall mounted pull-up bar provides stations for TRX users. Ideal for small spaces. Includes installation instructions and safety guidelines. Professional installation is recommended. Ships by truck.

7' long; 3-4 users	T16088-PS	\$699.95 ea.
14' long; 5-6 users	T16089-PS	\$1,129.95 ea.
21' long; 7-8 users	T16090-PS	\$1,549.95 ea.



Smart Suspension Trainer

Easy to adjust straps for required length. Two separated straps for desired width. Features pre formed foot cuffs, built in anchors on each strap and a strap connector.

.....	16927-PS	\$99.00 ea.
3 pack	16928-PS	\$297.00 pk.
6 pack	16929-PS	\$594.00 pk.

STRENGTH & CONDITIONING

Bodyweight Training



Xtreme Monkey Chin Up Bar

Bar is set 33" out from the wall allowing for flexibility of use. Ideal for anchoring rings, suspension trainers or bands. The 4" long bar itself has a textured powder coat finish for grip and is bolted flush to the support brackets so there is no play or movement. Features a 2' vertical wall attached bracket and a 7 hole bolt pattern on each bracket. Maximum weight capacity is 880 lbs. Mounting hardware included, be sure to consult a professional for installation. The Bar Add On Attachment includes a 45" long bar with one 2' vertical wall attached bracket to lengthen the chin up station.

- 45" Chin BarX16291-PS \$143.99 ea.
- 45" Add OnX16292-PS \$105.99 ea.



Xtreme Monkey Ceiling Mounted Multi-Grip Chin Up Bar

Bolted flush to the support brackets so there is no play or movement, just a solid fixture with a weight capacity of 880 lbs. For Light Commercial use. Hardware included. Seek professional advice for proper installation.

- 45"L x 9"W x 16"H.16845-PS \$112.99 ea.

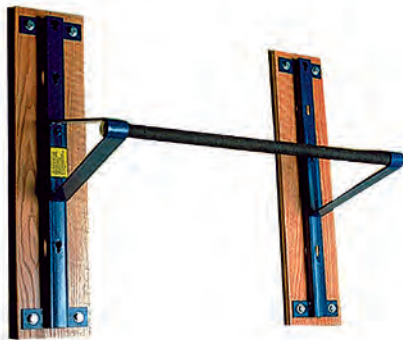

30" Deluxe Wall Chinning Bar

Provides 2' of height adjustments in 6" increments. All welded 30"W steel framework with powder coated finish. Oak back mounts not included. Maximum weight capacity 250 lbs.

-X25034-PS \$179.99 ea.



Sports Health™ 48" Wall-Mount Kip Chin/Pull Up Bar

Constructed from 2" x 1" heavy wall tube with 1.25" diameter knurled 48" long bar. Weighs 30 lbs.

- 50"W x 24"H x 30"D X16603-PS \$99.97 ea.



32" Adjustable Chinning Bar

Sturdy steel construction with 1.25" plated steel hand grip and two wall brackets made to mount to any wall. Set on 32" centers, easily adjusted in 6" increments by simply lifting bar and placing to desired height. No hardware included. Shipping weight: 22 lbs. Maximum weight capacity 300 lbs.

- X25066-PS \$139.99 ea.



Lifeline® Pullup Revolution™

Adjustable, assisted pull ups allow users to get more repetitions, focus on proper technique and get a better workout. New users will have more success and gain confidence. Simply attach the web strap with metal buckle to your bar and adjust the cable length which adds about 100 lbs. of assistance. Cables can be removed for less assistance. Includes strap, three cables, manual and DVD with challenging activities.

-53285-PS \$39.99 ea.



Sports Health™ Ab Straps

Made with heavy duty 2" wide nylon straps with padded arm bands for comfort. Steel 6" screw lock carabiners secure easily to bars. Sold in pairs.

.....54206-PS \$26.97 pr.



Bodysolid VKR/Dip/ChinStation

Oversized grips for comfort, cushioned arm rests and back pad. Push up station is 12" off the floor and chin bar has multiple grips. Frame is made from 2" steel with powder coat finish. Weighs 126 lbs. Ships by truck.

57"L x 82"H x 43"W.....16298-PS \$480.00 ea.



Pro-Style Ab Board

Strong 2" x 2" steel main frame with thick DuraFirm™ padding and oversized 8" foam rollers for comfort. Weighs 46 lbs.

54"L x 24"W x 52"H X53250-PS \$275.00 ea.



GO FIT® Go Slides

Designed with a low-friction, non-marking, material to slide smoothly on virtually any surface. The firm, foam grip pattern on the top side, means ideal traction for hands and feet. Large surface area is easier to use and maneuver. Each Slide measures 10.5" x 7.5". Includes two Go Slides, a carry bag and training manual.

.....54310-PS \$29.99 set



Sports Health™ Slider Discs

Maximize workouts with the versatile disc by increasing strength and flexibility in your upper and lower body. Polyester covered slide discs have soft foam centers for comfort with strong stitched seams. 9" diameter. Not designed for use on carpets.

5 Person Pack, 10 Slider Disc16722-PS \$34.97 pk.
25 Person Pack, 50 Slider Discs & Bag ...16723-PS \$169.97 pk.



Element Fitness Glide Discs

Great for multi-surface areas, these discs deliver constant resistance, adding intensity to your lunges, squats and upper-body workouts. With virtually every move, you'll engage your core, giving you amazing abs, glutes and thighs! Two double-sided sliding discs: blue smooth side for carpet, black fabric side for hard surfaces and wood. Discs are 7" in diameter and sold in pairs. Group Pack includes 10 pair of Glide Discs.

Glide Discs16251-PS \$13.99 pr.
10 Pair Group Pack16252-PS \$139.90 pk.

Core

Sports Health™ Toning Wheel

Dual wheels for stable operation, rubber contoured handles for secure, comfortable grip.

.....52070-PS \$9.97 ea.

**SKLZ Core Wheels**

Develop dynamic core strength and improve flexibility. With ergonomic foam handles for comfort and 5.7" wheels on each axle designed to allow for increased exercise variations to target the upper body area.

.....53917-PS \$35.99 pr.

**GO FIT® Power Ab Wheel**

Features dual wheels with wide treads and grippy traction surface with non-slip ergonomic rubber handles. Heavy duty, clear urethane wheel hubs for smooth rolling. Wheel diameter 7".

.....53949-PS \$19.99 ea.

**Pivoting Push Up Pods**

Made from heavy duty plastic with a rubberized bases and handles for grip. Base measures 7.75" in diameter. Pods snap together for storage.

.....16968-PS \$19.99 pr.

NEW!**GO FIT® Core Ab Ball**

The Ab Ball intensifies work for the middle muscles and provides more effective toning for the abs. Includes: 20cm Ab Ball, training DVD, and inflation tube.

.....54336-PS \$19.99 ea.

**Push Up Bars**

These convenient bars help reduce stress on the wrists and elbows and allow deeper dips to stretch muscles. Comfortable foam hand grips and protective non-skid feet.

.....52045-PS \$8.97 pr.

**Exercise Ab Mat**

Use with a variety of exercises that isolate upper and lower abs as well as the obliques and lower back muscles. Ideal for any fitness level the mat provides support and helps prevent injury. Durable with foam cushion base and a thick vinyl cover.

Single.....53978-PS \$32.99 ea.
6 Pack.....53979-PS \$184.99 pk.

**Power Cross Challenge**

Three color levels of difficulty. Ideal for stations, warm ups or obstacle courses. Carpeted mat with non-skid backing.

10'L x 30"W.....X53919-PS \$139.97 ea.

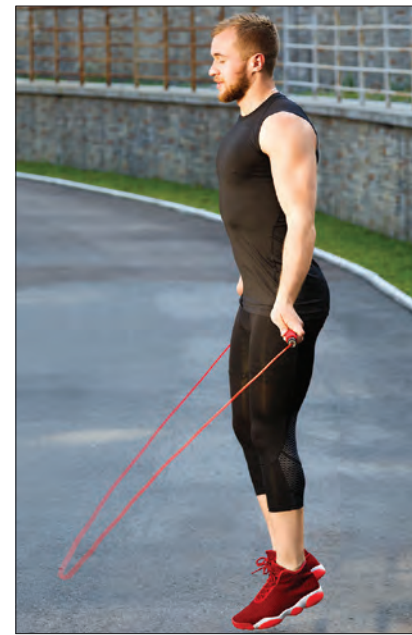

Sports Health™ Speed Ropes

Relaxed vinyl rope straightens out quickly and twirls great. Handles are contoured with ball bearings for smooth swivel.

8' Black	12169-PS	\$4.97 ea.
8' Black, Set of 6	12126-PS	\$24.97 pk.
9' Red	12170-PS	\$4.97 ea.
9' Red, Set of 6	12127-PS	\$24.97 pk.
10' Blue	12171-PS	\$4.97 ea.
10' Blue, Set of 6	12128-PS	\$24.97 pk.



Double Bearing Speed Rope Set

Made with a 3mm durable wire cable with a 15cm ergonomic handle with double bearing. 9' length.

Set of 6	12161-PS	\$29.99 set
----------------	-----------------	-------------



Xtreme Monkey

Handles are a little over .5 lb. each to give a bit extra effort in training. PVC rope flies true with excellent rotation.

9'	12117-PS	\$16.99 ea.
----------	-----------------	-------------



Weighted Jump Ropes

Made of solid rubber with foam covered swivel ball bearing handles. All ropes are 9' long.

1 lb. Green	12082-PS	\$24.99 ea.
2 lbs. Orange	12083-PS	\$28.99 ea.
3 lbs. Yellow	12084-PS	\$41.99 ea.
4 lbs. Blue	12085-PS	\$47.99 ea.



Kanga® Beaded Ropes

With a slightly thicker, multi-weave nylon rope and near unbreakable plastic segments, these ropes have nice balance and will last. Sold by the dozen.

7' Red/White	12101-PS	\$63.99 dz.
8' Blue/White	12102-PS	\$66.99 dz.
9' Green/White	12103-PS	\$69.99 dz.
10' Yellow/White	12104-PS	\$74.99 dz.



The ZONE Multi-Use Wall Rack

This convenient rack/holder will allow you to "untangle" the mess and hang jump ropes out of the way by size and type. Steel rack is 2"W x 24"L. Five 12" pegs will hold 100 jump ropes. Mounting hardware included.

.....	36172-PS	\$34.97 ea.
-------	-----------------	-------------

Stability Balls



Sports Health™ Exercise Balls

Rotation molded with raised ribs, anti-burst design and non-slip surface. Maximum weight 300 lbs.

45cm/18" Yellow	10362-PS	\$14.97 ea.
55cm/22" Blue	10363-PS	\$16.97 ea.
65cm/26" Red	10364-PS	\$18.97 ea.



GO FIT® Premium Stability Balls

Designed for fitness use, these stability balls are burst resistant, and weight tested to 1000 lbs.! Made with a non-slip surface. Colors may vary.

55cm/22" Red	52321-PS	\$19.99 ea.
65cm/26" White	52322-PS	\$19.99 ea.
75cm/30" Blue	52323-PS	\$19.99 ea.



Smart Stability Balls

Balls are rotationally molded PVC with a non-slip surface and 1000 lbs. anti-burst tested. Includes pump. Rack is made of .25" thick steel and measures 70"L x 5"W. Rings protrude from wall about 22".

55cm yellow	16960-PS	\$29.00 ea.
65cm green	16961-PS	\$34.00 ea.
75cm blue	16962-PS	\$39.00 ea.
Pack- includes one of each ball & rack	16963-PS	\$329.00 pk.
Rack only	16964-PS	\$229.00 ea.



Premium Stability Ball Packs

Includes nine balls and two posters featuring stretch, back and abs exercises!

55cm/22" Black 9 Balls & 2 Posters	66507-PS	\$209.99 pk.
65cm/26" Lt. Blue 9 Balls & 2 Posters	66508-PS	\$209.99 pk.
75cm/30" Dk. Blue 9 Balls & 2 Posters	66509-PS	\$209.99 pk.



Fitness Ball Storage Carts

Sturdy carts are made from heavy duty PVC with non-marring swivel casters. Nine Ball Cart—measures 62"L x 18.5"W x 67"H. 12 Ball Cart—measures 107"L x 19"W x 68"H.

9 Ball Cart	X36185-PS	\$159.99 ea.
12 Ball Cart	X36164-PS	\$209.99 ea.

Not made with Natural Rubber Latex.

Sports Health™ Fitness Ball with Legs

Promotes correct posture. Legs retract when weight is placed on the ball. Use for strength training, conditioning, and even in the office. Non-slip ribbed surface. Weight limit 300 lbs. Measures 25" in diameter.



.....	18251-PS	\$19.99 ea.
-------	-----------------	-------------

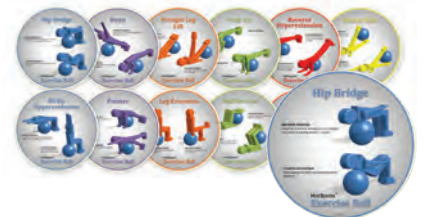

HotSpots® Exercise Ball

12 Body Balls HotSpots: Hamstring Press, Push Up, Hip Bridge, Straight Leg Lift, The Pointer, Reverse Hyperextension, Leg Extension, Sit Up Extension, Ball Reverse, The Swan, Glute Lift and Scissor Kick.

.....	21140-PS	\$44.99 set
-------	-----------------	-------------



GO FIT® Premium Wood Plyobox

Use jump training, or “plyos,” to exert maximum force in short, high intensity, bursts. Commercial quality, non-warping construction. Supports up to 350 lbs. Fast assembly. Includes training DVD and exercise book.

12" Plyobox	X54319-PS	\$59.99 ea.
18" Plyobox	X54320-PS	\$79.99 ea.
24" Plyobox	X54321-PS	\$99.99 ea.
3 Box Set (12", 18", 24")	X54322-PS	\$199.99 set



Xtreme Monkey 3 in 1 Wood Plyo Box

Crafted from premium, non-warping hardwood that can support up to 350 lbs.; and has machine edges for exact fit. Integral part of CrossFit and MMA training sessions. Pre-drilled pocket joints with no visible screws. Takes only a few minutes to assemble. Weighs 64 lbs.

.....	.54213-PS	\$144.99 ea.
-------	------------------	--------------

POWRfit® Plyometric Training Platforms

Each box is made of 1" steel tubing and 15 gauge steel with .75" plywood with .125" slip resistant rubber padding. Steel reinforced wide frame keeps platforms stable. Platforms nest for storage.



6"	X52540-PS	\$69.99 ea.
12"	X52541-PS	\$89.99 ea.
18"	X52542-PS	\$99.99 ea.
24"	X52543-PS	\$113.99 ea.
30"	X52544-PS	\$136.99 ea.
1 of each size	X52545-PS	\$439.99 set



Xtreme Monkey Soft Impact Plyo Boxes

Set includes 6", 12", and 18" foam boxes. Made from high density foam and covered with 18 oz. vinyl. The bottoms and tops are 30 oz. non-skid vinyl. Each box has a handle for easy repositioning and Velcro strips for stability when stacking. All boxes measures 30" x 36". Ships by truck.

3 Box Set	T54212-PS	\$718.99 set
-----------------	------------------	--------------



Vulcan Soft Impact Plyo Boxes

Blocks are made from high density foam with a durable vinyl cover. Boxes are secured for stacking with industrial strength Velcro® and have two reinforced handles for portability. Boxes measure 36" x 30" and come in four heights 6", 12", 18", & 24". Ships By Truck.

.....	T16975-PS	\$1,082.00 set
-------	------------------	----------------



Body-Solid Soft Sided Plyo Box

Solid and stable with durable stitched vinyl upholstery and foam interior. Resists compression. Flip and turn for heights of 20", 24", and 30" tall.

.....	.54211-PS	\$287.99 ea.
-------	------------------	--------------

Agility

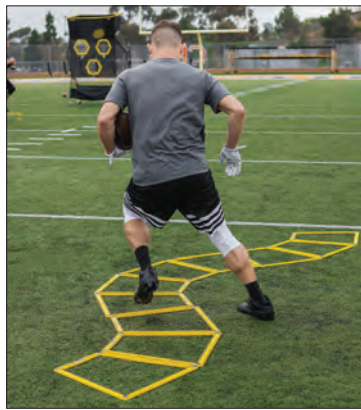
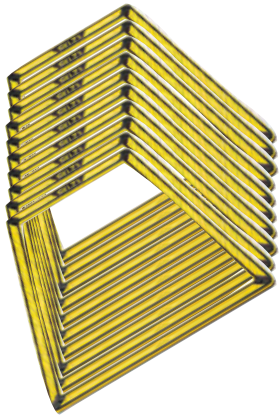

SKLZ® Agility Trainer Pro

Designed for curvilinear and customizable training patterns to train footwork in game like situations. Use on any surface, including grass, tracks and courts. Set includes 10 trapezoids with carry handle.

.....16978-PS \$89.99 set



Sports Health™ Octa-Rings

Rings snap together to create a variety of designs. Each ring measures 16.5" with a low profile .25" height. Set includes 12 octagons and can create a straight ladder 16' long. Includes carry bag.

.....54196-PS \$24.97 set



Rubber Spot Sets

Flat 9" or 12" rubber discs for indoors or out. Sold in a set of six, one of each color.

Set of 6, 9" size21026-PS \$11.97 set
 Set of 6, 12" size21059-PS \$24.97 set

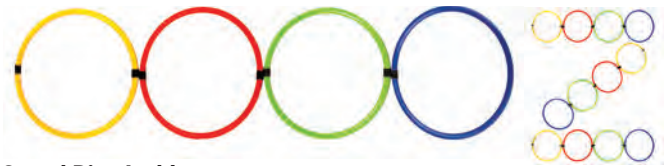

Speed Ring Ladder

Set includes 12 plastic hoops measuring 17.5" in diameter. Nylon web strapping loops each ring and are double stitched for strength so the ladder lays flat. Includes carry bag.

17.5"L x 17.5"W.....13104-PS \$15.99 set

Half Cone Pack

36 half cones and a carrying rack. Six of each color: red, yellow, green, blue, purple and orange.

Half Cone Pack .. 21025-PS \$23.97 set
 Carrier-only 21036-PS \$3.59 ea.

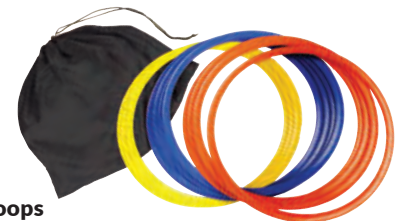

Sports Health™ 16" Flat Hoops

Use indoors or outside. Made from one piece molded plastic. Sold in a dozen set, three of each color: red, yellow, green and blue. Includes storage bag.

.....14004-PS \$16.97 dz.



Sports Health™ 3" Reaction Ball

This soft rubber ball improves hand-eye coordination and reaction time. Use solo on hard surfaces or walls or in a team setting. Excellent tool for baseball, softball and lacrosse drills.

Set of 610126-PS \$17.97 set

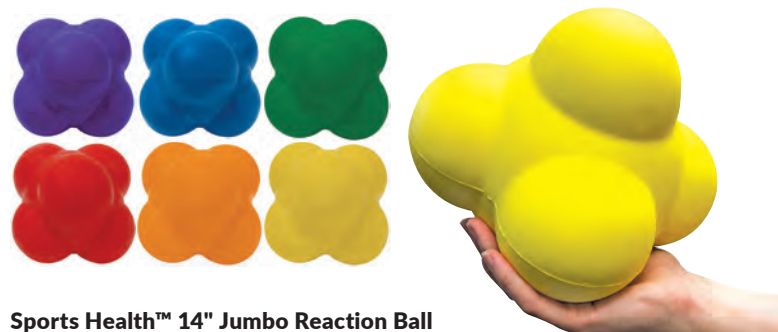

Sports Health™ 14" Jumbo Reaction Ball

Six-sided high-bounce rubber design causes the ball to leap and hop randomly. Sharpens depth perception while making training fun and effective. Great for soccer and football drills.

Set of 610590-PS \$49.97 set
 Assorted Colors10598-PS \$9.99 set



Smart Modular Agility Ladder™

Snap ladders together for desired length and connect rungs together to create the desired width! Create various patterns from double/triple lane ladders to obstacles, zig zag patterns and a full grid. Ladder features two 7.5' segments that snap together for a total ladder length of 15'. Rungs measure 17.5" wide and can clip anywhere along the nylon web straps. The Smart Organizer simplifies gathering and releasing ladder rungs preventing tangling and knotting. Includes handle for easy transport.

Single **16983-PS** \$59.00 ea.
 4 Pack **16984-PS** \$236.00 pk.



Sports Health™ Agility Ladder

Measures 22' long with 20" wide plastic rungs attached to web strap sides. Includes storage handle and carry bag.

Single Ladder **13131-PS** \$25.97 ea.
 Ladder 4 Pack **66497-PS** \$99.97 pk.



Sports Health™ Indoor Agility Ladder

Shift and slide resistant, will not mar floors. Ladder has 11 rungs.

15'L x 18"W. **13113-PS** \$39.97 ea.

SPRI® Rollout Ladder

Made from durable non-skid recycled rubber that lies flat when unrolled. Large ladder area is ideal for a variety of users. Weighs 11 lbs.

15'L x 16"W x .125" thick. **X53907-PS** \$78.99 ea.

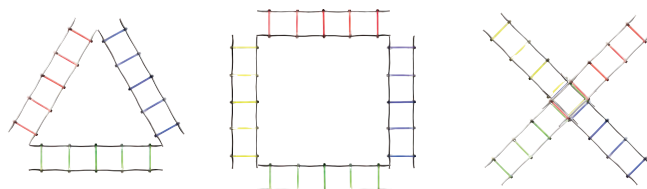

Sports Health™ Colored Agility Ladder 4 Pack

Four sections of 6.5' colored ladders can be set up in endless formations for a wide variety of exciting drills. The colored sections snap together with connectors to form a 26' long complete ladder. Plastic rungs are 20" wide and spaced 18" apart. Rungs are fixed to prevent slipping.

4 Pack- 4 sections **13123-PS** \$39.97 ea.
 Quad Pack- 16 sections **66498-PS** \$139.97 ea.

Agility Dot Mat

Use indoor or out for bounding/hopping drills, jump rope variations and more. Non-slip, .125" thick synthetic mat rolls for storage.

48"L x 40"W **X52357-PS** \$44.99 ea.



Agility



Body-Solid Weight Sled

Removable posts allow workout customization. Center weight horn for storage and additional resistance with attachment anchors for ropes, lifting bands and more. Weighs 68 lbs.

50"L x 31"W x 40"H16985-PS \$260.00 ea.



POWRfit™ Speed Sled

Easy to assemble and constructed of steel with a powder coat finish with 6.5" high Olympic post. Includes adjustable shoulder harness, 80" long leads and carry bag. Weighs 9 lbs.

21.5"L x 13.5"W16575-PS \$59.97 ea.



POWERMAX® Push/Pull Sled

Features adjustable width push posts, multiple push/pull options and folds for storage. Frame is constructed from 11 gauge steel with powder coat finish. Measures 24"W x 35"L x 35"H with upright post. Sled includes harness and 3" wide hook and loop closure belt that's adjustable up to 42" waist.

Sled with Belt & Harness X53659-PS \$409.97 ea.



POWERMAX® Tire Tether

Larger tires work strength while smaller tires work speed. Vary the time and distance of pulling sets. Includes nylon strap and hardware to attach tire (not included), 3" wide hook and loop closure belt adjustable to 42" waist, carry bag and instructions.

.....53247-PS \$54.97 ea.

NEW!



Weighted Training Softball Set

Use as part of a strengthening and conditioning program to help lessen the risk of injury and improve pitching skills. Features: Color coded weight system, rubber and cork centers, nylon carrying case. Weighted from 9-12 oz. 12 inches.

Set of 4. 17358-PS \$113.99 set

NEW!



Weighted Training Baseball Set

Use weighted baseballs in training programs to enhance throwing mechanics, arm speed, and arm strength, resulting in enhanced pitch velocity. Features: leather cover with rubber & cork core, color coded weights, nylon carrying case. Weighted from 9-12 oz. 9 inches.

Set of 4. 17384-PS \$28.99 set

NEW!



Weighted Football Trainer

Aids in developing muscle memory, improved ball retention skills and is perfect for running drills or warmups. Intermediate size. Choose 2 or 3 lbs.

2 lbs. 17386-PS \$19.99 ea.

3 lbs. 17387-PS \$22.99 ea.

Xtreme Monkey VPower Chute

Improves two key elements of speed-stride length and frequency. Chute opens while running for resistance. Velcro belt allows for mid-stride release during sprint for overspeed effect. This increases speed, explosiveness and acceleration. The built in mesh panels eliminate the tangling of strings found on other chutes. Constructed of all weather tear resistant fabric. Adjustable belt fits 20" to 42" waist.



.....16986-PS \$60.99 ea.

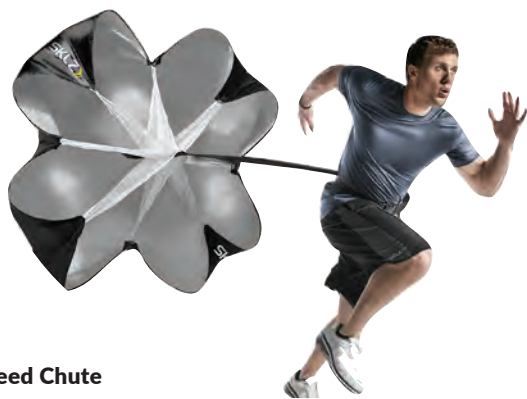

SKLZ® Speed Chute

Tangle free mesh pre-canopy connects to the nylon chute with heavy duty double stitched seams. The 54" chute provides 15-30 lbs. resistance depending on speed. The 360° rotating belt has a motion ring for ease of movement. One size fits most. Includes a carry bag.

.....53909-PS \$26.99 ea.

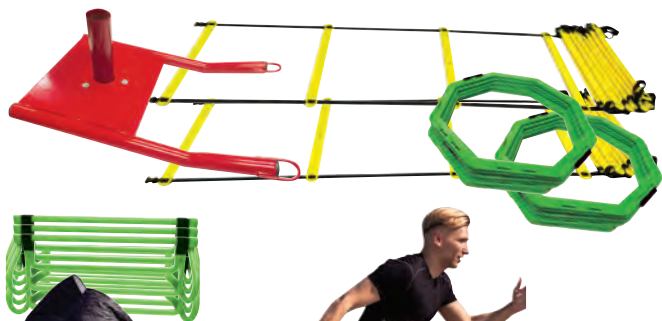

Sports Health™ Agility Pack

- 2 sets 54196 Octa-Rings
- 2 each 13131 Agility Ladder
- 2 each 54202 Speed Chute
- 2 sets 16720
- Nexus Hurdles set of 6
- 1 each 16575 Speed Sled
- 1 each 16573 Versatile Trainer
- 1 each 54204 Overspeed Trainer
- 1 each 54207 Hoop Holder
- 2 each 16579 RollerBag

.....16721-PS \$499.97 pk.



Sports Health™ Speed Chute

Tangle free pre-canopy connects to the nylon chute to force open chute and provide drag. The 46" chute provides 15-25 lbs. resistance. Web strap belt with neoprene padding measures 48" long. Velcro® belt closure. Includes carry bag.

Single.....54202-PS \$17.97 ea.
3 Chute Pack16719-PS \$52.97 pk.



Sports Health™ Station Pack

The book provides 6 week sport specific training programs or you can create your own. Items included are the most often used in the book.

- 2 ea. 13123 SPH Colored Agility Ladder 4 Pk
- 1 ea. 54202 Speed Chute
- 1 ea. 52550 Speed Harness
- 6 ea. 52517 6" Hurdles
- 1 ea. 10126 3" Reaction Ball
- 6 ea. 21048 9" Plastic Cones
- 1 ea. 38090 Speed, Agility and Quickness Book & DVD

.....66499-PS \$189.99 pk.



Sports Health™ Quick Release Training System

This unit is made with two 108" straps, connected to an adjustable 2" wide belt, via a durable quick release hook. The trainer holds the athlete back with the black strap and uses the red strap to quickly set the athlete free.

.....17261-PS \$19.99 ea.

Agility



Sports Health™ Evasion Belt

Players wear a waist belt that is connected to a belt with a Velcro® tear away middle. A player “wins” when they evade and break their connection to their opponent. Waist belts measure 44” with a snap buckle closure. The connecting belt measures 33” with a 60” total clearance between players. All belts are made from web strapping. Includes four Velcro® to use on belts as an optional challenge. Includes carry bag.

.....54201-PS \$7.97 set



Sports Health™ Power Builder

Includes two nylon web strap shoulder harnesses with D-ring for back to back connecting with 9’ long web strap belt with carabineers on ends. Includes carry bag.

.....54203-PS \$29.97 set



Sports Health™ Dual Over Speed Trainer

Excellent for increasing power, strength and agility. Designed with two 10’ long nylon covered latex tubes attached to a padded harness. Snap hooks on the ends enable unit to be secured to a fixed object or may be held by up to two partners. Waist belt is 2” wide and adjustable to 55”.

.....17263-PS \$68.99 ea.



4 Way Tug Of War

Four players going in four opposite directions, trying to be the first to grab the ball from their corner. A demanding, intense, but fun physical challenge. Set includes: one 4 way harness, four belts, four balls, four cones, eight carabineers and carry bag.

.....20054-PS \$169.99 set



Sports Health™ Speed Harness

Ideal for short and lateral sprints with the partner controlling the resistance level. Includes a one size fits all shoulder harness, a 10’ nylon strap with two large D rings and foam covered handle with carry bag.

.....52550-PS \$28.97 ea.



Sports Health™ Agility Training Gear

- A. Universal Shoulder Harness—2” nylon webbing, padded shoulder straps, and adjustable velcro waist belt.
.....17254-PS \$15.99 ea.
- B. Universal Waist Harness—2” nylon webbing, neoprene padding, two attachment rings, heavy-duty buckle.
.....17258-PS \$12.99 ea.
- C. 10’ Covered Resistance Tube—Strong webbed nylon cloth over durable rubber tube. Two attached carabiner clips.
.....17259-PS \$19.99 ea.
- D. 10’ Tow Rope—High strength 1” nylon webbing with two attached carabiner clips.
.....17260-PS \$9.99 ea.



Sports Health™ Versatile Trainer

Covered tubing provides resistance against forward motion of the arms and legs. Improves first steps and take off power. Partner stands behind to anchor or can also slowly jog for running resistance. Padded adjustable nylon straps attach to legs and arms. Includes carry bag.

.....16573-PS \$39.97 ea.



Sports Health™ Overspeed Trainer

Set includes two web strap 48" long belts with neoprene padding, a 7' long covered stretch strap and carry bag.

.....54204-PS \$29.97 set

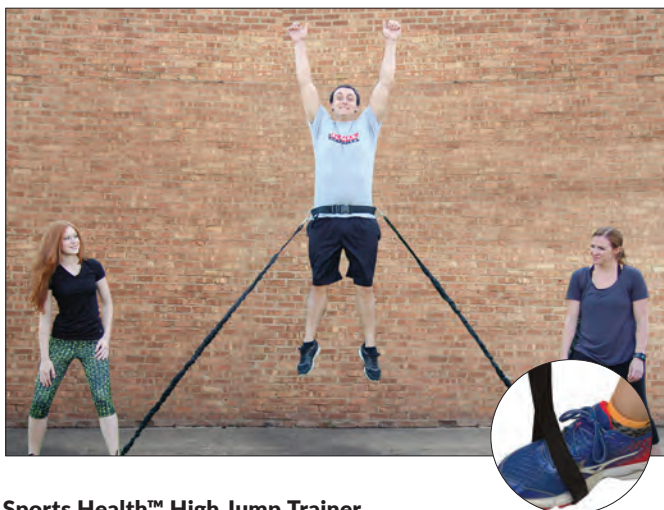

Sports Health™ High Jump Trainer

Resistance increases proportionately to the rate of acceleration of each jump. Anchor the cord ends and begin. Includes two 60" covered latex tubes, 2" wide hook and loop closure 42" long adjustable belt, carry bag and instructions.

.....16567-PS \$29.97 ea.



Sports Health™ Solo Over Speed Trainer

Helps athletes train to maximize strength, speed, and vertical jump. Train with a partner or anchor to a sturdy object with the strong nylon strap. 10' long cloth covered latex tube. Adjustable harness.

.....17262-PS \$34.99 ea.

NEW!



SKLZ® HOPZ 2.0 Vertical Trainer

The vertical trainer enables you to target specific muscles and is an excellent tool for engaging quads, calves, hamstrings and more. Also perfect for anyone training for football, basketball, or volleyball. Features multiple resistance levels which can be adjusted quickly with the patented padded belt, and ankle straps. Also includes durable cables and built-in shoe harnesses.

.....54358-PS \$69.99 ea.



SKLZ® Recoil 360°™

Build strength and conditioning for sprinting, leaping, shuffling or change of direction. Work with a partner or attach the leash to a stationary object. Includes an adjustable belt with free motion ring that allows movement in any direction, an 8' flexi-cord that safely stretches up to 20', a safety handle and storage bag.

.....53913-PS \$44.99 ea.

Obstacle Course

Fitness Equipment	Cardio	Low Body Strength	Upper Body Strength	Agility & Coordination	Global Movement Skills	Can Be Used For All Ages	Portable
Railyard Obstacle Course	yes	yes	yes	yes	yes	yes	yes
Treadmill	yes	yes	no	no	no	no	no
Stair Climber	yes	yes	no	no	no	no	no
Glider	yes	yes	no	no	no	no	no
Weight Machines	no	yes	yes	no	no	no	no



GREAT FOR KIDS!

Package #1 Includes:

- 5 Tall 18" Platforms
- 2 Short 9" Platforms,
- 7 Platform Caps
- 4 Rails With Nonslip Pads On Round Side
- Training Manual

Railyard Fitness Obstacle Course Package #1

Great for group and individual exercises! Course variations include: 38 ft. single rail for speed and agility drills like quick overs, or strength and flexibility exercises such as bear crawls; 2 – 19 ft. parallel rails for more complex speed and agility drills that combine multiple exercises; or position rails at 9", 18" 27" or 36" to add variety, challenge, and effectiveness to each of the exercise. Package includes: 5 tall platforms (bases), 2 short platforms, 7 platform caps, 4 rails, and training manual. Rails hold up to 600 lbs. Recommended space: 200 sq. ft. Ships via truck.



..... **T17272-PS** \$4,225.00 set



Package #2 Includes:

- 7 Tall 18" Platforms
- 2 Short 9" Platforms
- 7 Platform Caps
- 5 Rails With Pads On Round Side
- 1 Training Manual



Railyard Fitness Obstacle Course Package #2

Recommended for groups of 10 people and up. Strength training, speed, agility and flexibility are all within reach. With this package, you can have one rail at the high (36") position at all times. This set has everything needed to prepare even the most rigorous of challenges. Includes: seven tall platforms (bases), two short platforms, seven platform caps, five rails and training manual. Rails hold up to 600 lbs. Recommended space: 250 sq. ft. Ships via truck.



..... **T17273-PS** \$5,280.00 set



VULCAN Fat Grip Black Poly Plus Battling Rope

Constructed of polypropylene and polyester with two polyboot ends attached to make it resistant to fraying and very durable. This rope won't deteriorate, shed, and can be used in outdoor as well as indoor applications. The rope is 2" diameter.

20'L x 2"	X16548-PS	\$104.95 ea.
30'L x 2"	X16549-PS	\$133.99 ea.
50'L x 2"	X16550-PS	\$159.99 ea.

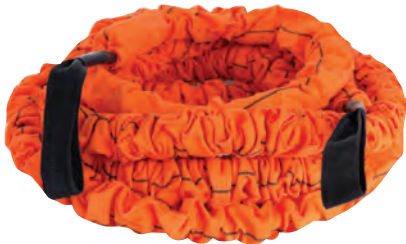

The Beast™ Slastix® Battle Rope

Unlike traditional ropes, which only allow a single plane of force, Battle Ropes incorporate Slastix® technology, with heavy resistance that elicits muscle contractions throughout the entire body up to three training planes simultaneously. Ropes have nylon wrist straps and are encased in a protective nylon sheath.

The Beast™

20'L; 47 lbs.	X53465-PS	\$143.99 ea.
20'L; 77 lbs.	X53466-PS	\$194.99 ea.
20'L; 105 lbs.	X53927-PS	\$234.99 ea.
20'L; 150 lbs.	X53928-PS	\$265.99 ea.

Son of the Beast™

10'L; 47 lbs.	X53929-PS	\$153.99 pr.
10'L; 77 lbs.	X53930-PS	\$204.99 pr.
10'L; 105 lbs.	X53931-PS	\$245.99 pr.
10'L; 150 lbs.	X53932-PS	\$276.99 pr.



Xtreme Monkey 10-Station Battle Rope Anchor

Weight loaded anchoring system features 10 welded D-rings. Commercial quality, powder coated, stainless steel frame. Works with Olympic style weights (not included).

28"W x 25"H... **X54333-PS** \$266.99 ea.



Xtreme Monkey Training Rope Anchor Station

Made from steel with powder coat finish and rubber base. Add up to 4- 45 lb. Olympic weight plates for additional ballast. Measures 23.5"W x 23.5"D x 6.5"H. Weighs 32 lbs. Weight plates and ropes sold separately.

..... **X53933-PS** \$199.99 ea.



Sports Health™ Training Rope Packs

Choose a 2 rope or 4 rope pack with poster and anchor station. Weight plates for additional ballast on anchor station not included.

Rope: 15'L x 1.5"

2 Pack	X16559-PS	\$339.97
4 Pack	X16560-PS	\$499.97

Rope: 30'L x 1.5"

2 Pack	X16852-PS	\$409.97
4 Pack	X16856-PS	\$709.97

Rope: 50'L x 1.5"

2 Pack	X16561-PS	\$469.97
4 Pack	X16562-PS	\$739.97



Xtreme Monkey 30' or 50' Sleeved Battle Ropes

Sleeve protects rope from fraying while the clamps secure grips in place and prevent excessive wear on the capped ends. Aluminum handles cover the vinyl capped ends for additional protection and user comfort.

30'L x 1.5" diameter, weighs 20 lbs.16851-PS	\$164.99 ea.
50'L x 1.5" diameter, weighs 30 lbs.16850-PS	\$209.99 ea.



Xtreme Monkey Rope Anchor or Hanger

Both are made of steel construction and include mounting hardware.

A. 13"L x 2.5"W...	X53467-PS	\$29.99 ea.
B.....	16240-PS	\$39.99 ea.

Hurdles



Sports Health™ Nexus Hurdles

Folds flat for storage. Made from molded plastic.

Set of 6 Hurdles16720-PS	\$39.97 set
Set of 6 Hurdles with Carry Strap17200-PS	\$43.97 set



Sports Health™ Training Hurdles

Increase speed, higher knee lift and gain agility skills with these sturdy .75" O.D. PVC hurdles. Orange only.

Set of 6, 6"42187-PS	\$29.97 set
Set of 6, 6" Hurdles with Carry Strap16994-PS	\$33.97 set
Set of 6, 12"42188-PS	\$34.97 set
Set of 6, 12" Hurdles with Carry Strap16995-PS	\$38.97 set
Set of 6, 18"42189-PS	\$56.97 set
Set of 6, 18" Hurdles with Carry Strap16996-PS	\$60.97 set
Set of 6, 24"42190-PS	\$61.97 set
Set of 6, 24" Hurdles with Carry Strap16997-PS	\$65.97 set



Smart Hurdles™

Versatile hurdles for use in agility or over/under training. Each hurdle is constructed from high impact ABS plastic with a sturdy 3 point base and folding support leg for easy storage. All sets include carry handle.



Set of 6, 6" Hurdles42103-PS	\$99.00 set
Set of 6, 12" Hurdles42104-PS	\$109.00 set
Set of 3, 12"-18" Adjustable Hurdles42105-PS	\$169.00 set
Set of 3, 21"-36" Adjustable Hurdles42106-PS	\$199.00 set
Set of 3, 27"-42" Adjustable Hurdles42107-PS	\$209.00 set



Sports Health™ Six Color Training Hurdle Set

These hurdles are made from sturdy PVC tubing. Each size available in a set of 6, one of each color.

Set of 6, 6"52517-PS	\$31.97 Set
Set of 6, 6" Hurdles with Carry Strap16998-PS	\$35.97 set
Set of 6, 12"52518-PS	\$39.97 set
Set of 6, 12" Hurdles with Carry Strap16999-PS	\$43.97 set

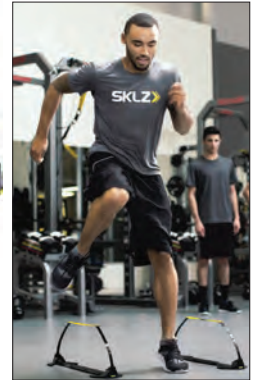

SKLZ® Speed Hurdle Pro

Hurdles feature a highly durable base, low profile design for feet of all sizes and innovative bounce back construction when stepped on. Adjusts from 6" to 9" to 12" high with one button. Folds for storage.

Set of 6 Hurdles with Case16993-PS	\$62.99 set
----------------------------------	------------------	-------------



Sports Health™ 6X Hurdles

Use for multi-directional speed, agility and plyometric training. One piece twist design will stand up to the biggest beatings and heaviest of athletes. 6" high.

Set of 6 Hurdles16991-PS	\$44.99 set
Set of 6 Hurdles with Carry Strap16992-PS	\$48.99 set
Carry Strap (only)54207-PS	\$4.97 ea.



**Sports Health™
Telescopic Agility Sticks**

The 1.375" diameter plastic pole telescopes to a maximum height of 64".
Set of 6**.54208-PS** \$44.97 set



SlotCones™

Innovative slot design allows any size hoop or crossbar to be locked into the cone. Choose from 12 vertical positions or five horizontal (from 3" to 18" high). SlotCones are heavier than and twice as strong as a typical cone. Add optional weighted rubber bases for enhanced stability. Lock-In crossbars fit snugly into the horizontal slots. Cones: 18.5"H x 8"W. Crossbars: 40" long.
Set of 6 SlotCones**.21217-PS** \$48.99 Set
Set of 6 Lock-In Crossbars 40"L**.21218-PS** \$34.99 Set
Weighted Rubber Base 8.75"L X 8.75"W ... **.21219-PS** \$7.99 Ea.
Slotcones Activity Kit—6 SlotCones & 6 Crossbars
.....**.66773-PS** \$79.99 Set

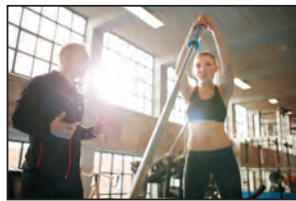

Landmine

Portable for use in or out of the weight room; includes handle for easy transport. Solid steel. Nonskid rubber bottom. Assembly required. Weighs 80lbs Full bearing construction.
19.5"L x 16"W.**.16269-PS** \$262.99 ea.



Olympic Weight Tree

- Holds 2" olympic weight plates.
- Rubber base to protect floors
- Weighs 29 lbs

22.0"L x 18.0"W x 37.0"H **X52901-PS** \$84.99 ea.



Portable Landmine Post

Thumb knob secures bar for stability with and end cap to protect floors. Ideal for any landmine exercises. Swivel design allows for total rotation.
.....**.16742-PS** \$46.99 ea.



Weight Tree & Bar Holder

- 2" x 3" & 3" x 3" steel construction
- Powder coated and rubber foot tabs
- Weighs 34 lbs.
- Plates not included.

20"L x 23"W x 40"H **X16598-PS** \$133.99 ea.



Body-Solid® Vertical Bar Rack

Heavy steel base with corner bolt holes to secure to floor. Weighs 22 lbs.
12"L x 12"W x 9"H **X16741-PS** \$110.99 ea.



**Body-Solid®
Olympic Bar & Plate Rack**

Heavy steel construction. Weighs 31 lbs.
20"L x 23"W x 40"H **X16740-PS** \$128.99 ea.



Bars & Collars



OLYMPIC BARBELLS	York Barbell 7' Olympic Bar	Troy Barbell 7' Olympic Bar	Body-Solid 7' Olympic Bar	Cap Barbell 7' Olympic Bar	Troy Barbell 6' Olympic Bar	Cap Barbell Olympic Curl Bar
Tested	1500 Lbs.	1200 Lbs.	1000 Lbs.	500 Lbs.	350 Lbs.	200 Lbs.
Grip	32mm	28mm	30mm	1.25"	Medium	1"
Knurl	Side	Light Side	Side	Medium Side	Side	Medium Side
Weighs	44 Lbs.	42 Lbs.	44 Lbs.	36 Lbs.	30.5 Lbs.	18 Lbs.
Note	Chrome	Light Commercial	Brass Bushings	Rotating Sleeves	51" Spread	W/Collars
SKU	X52626-PS	X52379-PS	X52604-PS	X52723-PS	X52669-PS	X52724-PS
Price	\$249.99 ea.	\$219.99 ea.	\$195.99 ea.	\$129.99 ea.	\$124.99 ea.	\$71.99 ea.



Xtreme Monkey Straight Steel Swiss Bar

Steel construction. Includes two black steel collars. Weighs 22 lbs.
83"L x 7.5"W x 2.75"H **X16604-PS** \$130.99 ea.



Tricep Olympic Bar

Diamond knurl with a 1" grip. Test weight 200 lbs.; weighs 23 lbs.
34"L **X54162-PS** \$89.99 ea.



Hex Olympic Bar

Medium knurl with a 1" grip. Test weight 1000 lbs.; weighs 66 lbs.
56"L **X54161-PS** \$189.99 ea.

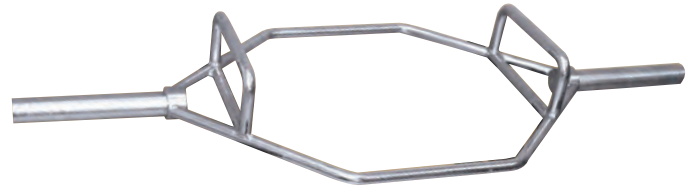

POWRfit Shrug Bar

Knurled and chrome plated commercial quality shrug bar. Test weight 800 lb.; weighs 72 lbs.
56"L **X16591-PS** \$199.99 ea.

Lock-Jaw Collars

Solid nylon injection molded frame and pads.
..... **16594-PS** \$38.99 pr.



Sports Health™ Barbell Clasp

Quick release locking for one handed use.
Injection molded plastic.
Black **16887-PS** \$12.99 pr.



Clamp Collars

Quickly tightens for fast changing of weights.
Made of high impact molded plastic.
..... **52722-PS** \$49.99 pr.



York® Barbell Spring Collars

York collars with rubber handle.
..... **53191-PS** \$6.99 pr.



Body-Solid Colored Olympic Bumper Plates

Each plate is fitted with a metal sleeve for proper fit and easy sliding. Solid, high quality rubber.



10 lb. Green	X16628-PS	\$83.99 pr.
15 lb. Black	X16633-PS	\$69.99 pr.
25 lb. Yellow	X16629-PS	\$129.99 pr.
35 lb. Blue	X16630-PS	\$156.99 pr.
45 lb. Red	X16631-PS	\$210.99 pr.

Plate Sets

150 lb. Plate Set includes 2 of each: 15, 25 and 35 lb. plates. 260 lb. Plate Set includes 2 of each: 10, 25, 35 and 45 lb. plates. Ships by Truck.

150 lb. Bumper Plate	T16650-PS	\$349.99 set
260 lb. Bumper Plate Set	T16651-PS	\$569.99 set



Body-Solid Colored Olympic Grip Plates

Plates have metal sleeve to retain shape and provide secure fit for plates. 140 lb. Plate Set includes 2 of each: 10, 25 and 35 lb. plates. 255 lb Plate Set includes: 4- 5 lb. plates, and 2 of each of 2.5, 10, 25, 35 and 45 lb. plates. Ships by Truck.

2.5 lb. Gold	X16637-PS	\$10.50 pr.
5 lb. Blue	X16638-PS	\$21.50 pr.
10 lb. Green	X16639-PS	\$41.99 pr.
25 lb. Yellow	X16640-PS	\$103.99 pr.
35 lb. Blue	X16641-PS	\$146.50 pr.
45 lb. Red	X16642-PS	\$187.99 pr.

Plate Sets

140 lb. Colored Grip Plate	T16654-PS	\$269.97 set
255 lb. Colored Grip Plate	T16655-PS	\$469.97 set



York Barbell 275 lb. Colored Rubber Bumper Set

Set includes: 2 of each: 10, 25, 35 and 45 lb. colored bumper plates, a 7' long 700 lb. test bar and a pair of spring collars. Ships by Truck.

	T16649-PS	\$539.99 set
--	------------------	--------------

Body-Solid Black Olympic Bumper Plates

Easy on floors and will not crack or tear. Fitted with a metal sleeve to maintain proper shape.



10 lb.	X16632-PS	\$62.99 pr.
15 lb.	X16633-PS	\$69.99 pr.
25 lb.	X16634-PS	\$99.99 pr.
35 lb.	X16635-PS	\$127.99 pr.
45 lb.	X16636-PS	\$164.99 pr.

Plate Sets

150 lb. Plate Set includes 2 of each: 15, 25 and 35 lb. plates. 260 lb. Plate Set includes 2 of each: 10, 25, 35 and 45 lb. plates. Ships by Truck.

150 lb. Black Bumper Plate	T16652-PS	\$294.97 set
260 lb. Black Bumper Plate	T16653-PS	\$489.97 set



Body-Solid Black Olympic Grip Plate

Plates have metal sleeves to retain shape and provide secure fit to plates. Quad design for easy grip. 140 lb. Plate Set includes 2 of each: 10, 25 and 35 lb. plates. 255 lb Plate Set includes: 4- 5 lb. plates, and 2 of each of 2.5, 10, 25, 35 and 45 lb. plates. Ships by Truck.

2.5 lb.	X16643-PS	\$9.50 pr.
5 lb.	X16644-PS	\$19.50 pr.
10 lb.	X16645-PS	\$39.50 pr.
25 lb.	X16646-PS	\$96.50 pr.
35 lb.	X16647-PS	\$134.50 pr.
45 lb.	X16648-PS	\$172.99 pr.

Plate Sets

140 lb. Black Grip Plate	T16656-PS	\$249.99 set
255 lb. Black Grip Plate	T16657-PS	\$439.99 set



York Barbell 300 lb. Olympic Weight Sets

Set includes a 45 lb. bar with 1000 lb. test, pair of spring collars and 14 grip plates: 2 each: 2.5 lb., 10 lb., 25 lb., 35 lb., 45 lb., and four 5 lb. Ships by Truck.

Uncoated Cast Iron Set	T53373-PS	\$419.99 set
Rubber Coated Set	T54149-PS	\$559.99 set

Weight Lifting Accessories



Sports Health™ Fitness Mega Bands

Resistance band loops are an ideal way to build strength, tone muscle and rehab injuries without the hassle of heavy metal free-weights. Comes in a wide variety of resistance levels. 41" long and 3/16" thick.

5-15lbs, .25"W Yellow17231-PS	\$9.99 ea.
15-25lbs, .5"W Red17232-PS	\$12.99 ea.
25-50lbs, .8"W Green17233-PS	\$15.99 ea.
35-70lbs, 1.25"W Black17234-PS	\$19.99 ea.
50-125lbs, 1.75"W Lime17235-PS	\$24.99 ea.
65-175lbs, 2.5"W Blue17236-PS	\$28.99 ea.
85-230lbs, 3.25"W Orange17237-PS	\$35.99 ea.
120-300lbs, 4"W Grey17238-PS	\$39.99 ea.
Toning Pack (two each: yellow, red, green, black)54292-PS	\$97.97 pk
Muscle Build Pack (two each: lime, blue, orange, grey)54293-PS	\$219.97 pk
Complete Pack (16 Total—two of each color)54294-PS	\$299.97 pk

Sports Health™ Tricep Rope

Nylon end stops are reinforced with fiberglass.

24"L 16595-PS	\$18.99 ea.
30"L 16596-PS	\$25.99 ea.



Element Fitness Bar Pad

Made from high density foam padding with a durable nylon cover and Velcro® closure.

14"L, 3" diameter16264-PS	\$20.99 ea.
-------------------	---------------	-------------



Sports Health™ Lifting Chains

These 60" long loading chains include end hooks. Use one or more chains per bar side to improve strength. Bar collars sold separately.

Low 20 lb. X16697-PS	\$99.99 pr.
Medium 30 lb. X16698-PS	\$99.99 pr.
Heavy 50 lb. X16699-PS	\$149.99 pr.
Collar to Attach Chains16700-PS	\$14.99 pr.

Gym Chalk

Fine quality, ideal for weight lifting, climbing walls or gymnastics. Wrapped in 2 oz. blocks, 8 blocks per lb.

.....	52306-PS	\$11.99 ea.
-------	----------	-------------



Weight Lifting Belt

SM, 28"-35.5"...	52486-PS	\$29.99 ea.
MD, 31"-38.5" ..	52487-PS	\$29.99 ea.
LG, 33"-40".....	52488-PS	\$29.99 ea.
XL, 36"-43.5" ...	52489-PS	\$29.99 ea.
2X, 38"-45.5" ...	52490-PS	\$29.99 ea.



Sports Health™ Wrist & Forearm Roller

Heavyweight steel construction with rubber grips and nylon rope. Works with any standard size weight plates.

.....	52900-PS	\$13.97 ea.
-------	----------	-------------



Sports Health™ Head Harness

Constructed of padded high density neoprene to absorb shock and prevent cuts and chafing. Heavy D-rings and steel chain for plate attachment.

.....	16268-PS	\$16.97 ea.
-------	----------	-------------





Body-Solid Preacher Curl

Isolate muscles for maximum workout. Ships by truck.

41"L x 31"W x 35"H, 74 lbs.
..... **53257-PS** \$395.00 ea.



Body-Solid Flat Bench

Ideal for standard workouts. Ships by truck.

46"L x 23"W x 20"H, 42 lbs.
..... **53260-PS** \$200.00 ea.



Body-Solid FID Bench

Flat, incline and decline positions. Ships by truck.

57.5"L x 25.5"W x 18"H, 72 lbs.
..... **16315-PS** \$475.00 ea.



Body-Solid Leg Press/Hack Squat

Variable start/stop positions. Ships by truck.

83"L x 34"W x 56"H, 317 lbs.
..... **53252-PS** \$1,495.00 ea.



Body-Solid Glute/Ham Machine

Vertical and horizontal adjustments. Ships by truck.

79"L x 33"W x 51"H, 149 lbs.
..... **16316-PS** \$615.00 ea.



Body-Solid Flat Olympic Bench

2" x 3" main frame construction. Ships by truck.

68"L x 50"W x 48"H, 109 lbs.
..... **16317-PS** \$765.00 ea.



Body-Solid Squat Rack

Maximize squats and presses. Ships by truck.

80"L x 71"W x 89"H, 343 lbs.
..... **16318-PS** \$1,450.00 ea.



Body-Solid Multi-Press Rack

Perform squats, calf raises, lunges, dead-lifts, upright rows, and more. Weight plates, bar and collars sold separately. Ships by truck.

45"L x 64"W x 74"H, 140 lbs.
..... **16752-PS** \$585.00 ea.



Body-Solid 45° Back Hyperextension

Increase flexibility, improve circulation. Ships by truck.

50"L x 26"W x 36"H, 108 lbs.
..... **16751-PS** \$290.00 ea.

Flooring

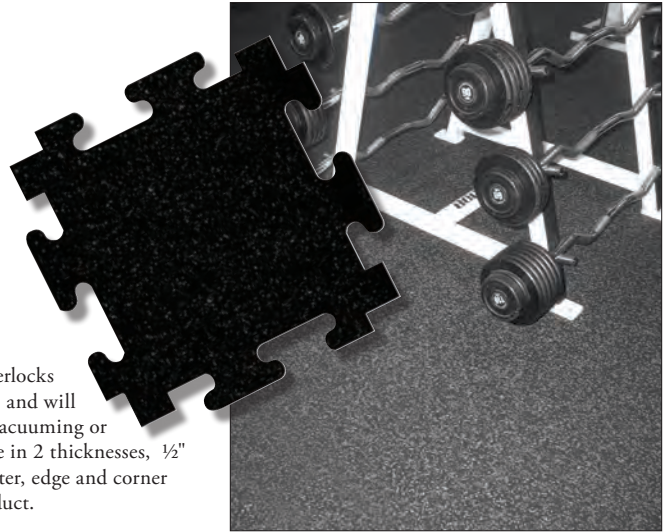
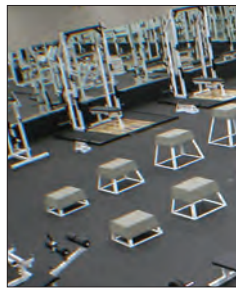

Interlocking Rubber Flooring

Reduces noise, provides anti-fatigue benefits and protects floors from damage. Interlocks seamlessly for a smooth appearance. Connecting tabs are over 6" wide and 4" deep and will not separate. Easy to install with no adhesive necessary. Keep clean by sweeping, vacuuming or lightly mopping. Easy to sanitize. Constructed for indoor or outdoor use. Available in 2 thicknesses, 1/2" and 3/4" and your choice of colors. Tiles measure 30" x 30" and are available in center, edge and corner cuts. Call for freight quote- our regular shipping policy does not apply to this product.

SOLID BLACK

Center: Thickness .5".....	C52637-PS	\$26.50 ea.
Corner: Thickness .5".....	C52638-PS	\$26.50 ea.
Edger: Thickness .5".....	C52639-PS	\$26.50 ea.
Center: Thickness .75".....	C52640-PS	\$27.99 ea.
Corner: Thickness .75".....	C52641-PS	\$27.99 ea.
Edger: Thickness .75".....	C52642-PS	\$27.99 ea.

FLECK COLOR

Center: Thickness .5".....	C52643-PS	\$31.99 ea.
Corner: Thickness .5".....	C52644-PS	\$31.99 ea.
Edger: Thickness .5".....	C52645-PS	\$31.99 ea.
Center: Thickness .75".....	C52646-PS	\$35.50 ea.
Corner: Thickness .75".....	C52647-PS	\$35.50 ea.
Edger: Thickness .75".....	C52648-PS	\$35.50 ea.

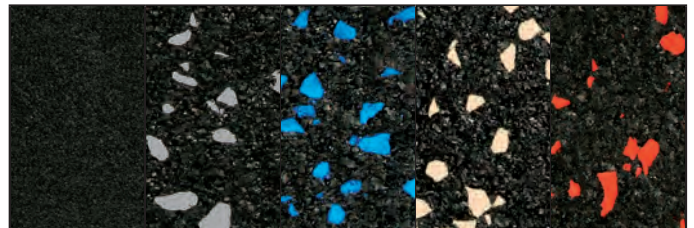

Interlocking Floor Tile

Absorbs shock of noise and training impact. Made from 100% post consumer tire rubber and post industrial EPDM rubber. Using these tiles can qualify your facility for LEEDS credits. Each tile measures 24" x 24" and is 3/8" thick. Choose center, corner and border pieces. Call for a freight quote- our normal shipping policy doesn't apply to this product.

Corner

Solid Black	C16331-PS	\$12.99 ea.
Gray Fleck	C16334-PS	\$12.99 ea.
Blue Fleck	C16337-PS	\$12.99 ea.
Tan Fleck	C16340-PS	\$12.99 ea.
Red Fleck	C16343-PS	\$12.99 ea.

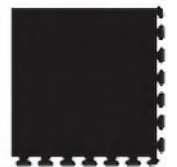

Center

Solid Black	C16330-PS	\$12.99 ea.
Gray Fleck	C16333-PS	\$12.99 ea.
Blue Fleck	C16336-PS	\$12.99 ea.
Tan Fleck	C16339-PS	\$12.99 ea.
Red Fleck	C16342-PS	\$12.99 ea.



Border

Solid Black	C16332-PS	\$12.99 ea.
Gray Fleck	C16335-PS	\$12.99 ea.
Blue Fleck	C16338-PS	\$12.99 ea.
Tan Fleck	C16341-PS	\$12.99 ea.
Red Fleck	C16344-PS	\$12.99 ea.



3/8" Thick Rolled Flooring

Each roll is 4' wide and made from 100% recycled rubber. Available in solid black or with color fleck. Can be laid flat or adhered to floor with double sided tape or polyurethane based adhesive. Call for freight quote- our regular shipping policy does not apply to this product.

25'L X 4'W Roll

Solid Black	C52631-PS	\$264.99 ea.
Fleck Color	C52634-PS	\$345.99 ea.

50'L X 4'W Roll

Solid Black	C52632-PS	\$529.99 ea.
Fleck Color	C52635-PS	\$692.99 ea.



Pro Style Training Gloves

Hook and loop strap for ease of use and durable, long lasting synthetic leather.

12 oz. **52193-PS** \$39.99 pr.



Neoprene Heavy Bag Gloves

Durable construction with mesh palm with anti-microbial lining one size fits most.

12 oz. **52192-PS** \$19.99 pr.



Partner Training Kit

Synthetic leather glove with neoprene palm and full glove backing on punch mitt. Set includes two gloves and two punch mitts

. **53836-PS** \$36.99 set



Everlast Mitt & Glove Pack

Pack includes a pair of neoprene heavy bag gloves and Mantis Punch Mitts.

. **16965-PS** \$56.99 pk.



Mantis Punch Mitts

Moisture absorbing and anti-microbial lining with mesh back for breathability and comfort.

. **53835-PS** \$43.99 pr.



Everlast Leather Punch Paddles

Unique grip allows a trainer to feel less impact on the hand and wrist. High quality leather construction with closed cell C3 foam for increased cushioning. Sold in pairs.

. **16261-PS** \$59.99 pr.



Strike Shield

Great partner workout tool! Multiple straps for hand placement, made from premium synthetic leather with high density foam padding.

. **X53539-PS** \$51.99 ea.



Leather Speed Bag

Premium grade leather for extreme durability and improved functionality.

10" x 7"

Speed Bag **.53541-PS** \$39.99 ea.

Repl. Bldr **.53542-PS** \$6.99 ea.

Swivel **.53544-PS** \$21.99 ea.



Photo©2009
Century, LLC
Wavemaster®
is A Registered
Trademark Of
Century, LLC.

Cardio Wavemaster™

Striking surface is 40" long with a 10.5" diameter and high density foam inner with a poly shell. Low profile base can be filled with sand or water to provides approximately 170 lbs. of ballst. Four height adjustments.

Black . . . **X52159-PS** \$149.99 ea.

Red. **X52160-PS** \$149.99 ea.

Blue . . . **X52161-PS** \$149.99 ea.



C3 Foam Heavy Bag

Premium NevaTear™ cover with reinforced webbing and Blended filler mix fibers for resilient shock absorption Heavy duty straps for security with double end loop.

50.3"L x 14.3" diameter

100 lbs. **X53837-PS** \$134.99 ea.



Century® Heavy Bags

High tensile strength Diamond Tech™ fabric cover. Filled with sand bags, shredded cotton and polyester fibers. Durable web straps for hanging.

40"L x 13" dia.

70 lb. . . . **X52190-PS** \$106.99 ea.

42"L x 14" dia.

100 lb. . . **X52191-PS** \$119.99 ea.



Fight Monkey® Heavy Bag Wall Mount

Attaches to any standard wall and holds up to 100 lb. heavy bag. Arm extends 27" away from the wall, and can be swiveled to either side when not in use. Bag not included.

. **X52183-PS** \$99.99 ea.

Steps

NEW!

The Original Step®

Not just for leg workouts, The Step® can be use horizontally, or on an incline, and adjusts from 4" to 6" to 8" using the included risers. Large 40"L x 14"W stepping area with non-slip ribbed surface. Supports up to 350 lbs. Measures 43"L x 16"W. Class Pack includes: 10 platforms, 40 risers, 1 step cart - 36013 & 1 riser cart - 36014. (See page bottom for cart details.)

- Single: 1 platform & 4 risers **X52865-PS** \$94.95 ea.
- 10 Pack: 10 platforms & 40 risers **T52866-PS** \$999.99 pk.
- 12 Pack: 12 platforms & 48 risers **T66175-PS** \$1,199.99 pk.
- Steps & Storage Pack – 10 platforms, 40 risers, step cart & risercart
..... **T66807-PS** \$1,329.99 pk.



NEW!



The Step® Stackable Riser

Choose from 4" or 6" models. Platform top features nonslip, textured surface while the bottom includes eight nonskid feet for extra safety. Sizes may be used together to achieve desired height.

- 22"L x 12"W
- 4" Gray **X54337-PS** \$22.99 ea.
- 6" Blue **X54339-PS** \$29.99 ea.
- 4" Gray, 10 Pack **X54338-PS** \$229.99 pk.
- 6" Blue, 5 Pack **X54340-PS** \$149.99 pk.



Element Fitness® Aerobic Fitness Step

Excellent non-slip ribbed surface allows users a solid grip whether it's for feet or hands! The fitness step itself is 43"L x 16"W x 4"H with the support blocks adjusting the height from 4" to 6" or 8". Includes 1 platform and 4 risers. Maximum user capacity is 300 lbs. Rack stores 6 steps and risers. Metal construction with smooth rolling casters.

- 44"L x 19"W x 62"H, 33 lbs.
- Single..... **X16262-PS** \$78.99 ea.
- 10 Pack: 10 platforms & 40 risers **.16263-PS** \$839.99 pk.
- 6 Pack: 6 Platforms & 24 Risers & Rack ... **.16950-PS** \$829.99 pk.
- 12 Pack: 12 Platforms &
48 Risers & 2 Racks **.16951-PS** \$1,599.99 pk.



Fitness Step Cart

Constructed of PVC plastic with non slip grips on bottom shelf and 3" ball bearing casters. Steps not included.
45"L x 19"W x 60"H
..... **X29300-PS** \$198.99 ea.



Riser Cart

Holds up to 60 step risers. Built from structural grade PVC that will not rust, corrode, chip or peel. Risers not included.
46"L x 19"W x 42"H
..... **X36014-PS** \$205.99 ea.



Step Cart

Step cart transports up to 12 steps on smooth rolling, non-marring swivel casters. Built from structural grade PVC. Steps not included.
46"L x 19"W x 60"H
..... **X36013-PS** \$224.99 ea.



Vulcan Limitless Timer

- Interval timing w/ work and rest times & stopwatch function
- Large 4" digits and loud timer alarm
- Includes AC adapter w/ 15' cord, wall mount brackets and remote
- Remote requires two "AAA" batteries (not included)

28.5"L x 6.25"H x 1.625"D **48185-PS** \$259.00 ea.



Count Up/Down Clock

- Counts up/down to 99:59
- Bright LED 4" digits, 12/24 hr. clock
- Built-in control panel with horn
- 120v AC power

13"L x 6"H x 4"W **48127-PS** \$199.97 ea.



Cross Timer

Features a 10-second countdown and can be programmed to count up to or down from a set time. It also has a 20/10 tabata interval programmed in. Will function as a clock and mount to the wall. Includes adapter with cord, instruction manual and remote. Remote requires batteries.

20"L x 6.5"H x 1.5"D, 3.8 lbs. **48149-PS** \$164.97 ea.



MegaTimer

Features time and date, countdown timer, stopwatch, alarm and temperature. Includes the unique Student and Team Selector buttons to randomly choose students to answer or teams to go first. Includes a Random mode that operates as dice, a spinner or generates random numbers for math problems. Requires six "AA" batteries, not included.

9.5"L x 6.5"H **48182-PS** \$54.99 ea.



Multi-Sport Portable Scoreboard

- Clock counts up/down from 99:59
- Scores to 199, 4" LED display
- Workout, practice, circuit modes
- Control panel, possession indicator
- Horn, lights & period indicator
- Battery charger (battery not included)

22"L x 15"H x 8"D **X49014-PS** \$399.99 ea.

Battery Power Pack **49017-PS** \$139.99 ea.



Big Digit Timer

This small timer can easily stand on a table, clip on clothes or attach via magnet.

Built in memory, large ¾" display and loud alarm at "time up". Powered by one "AAA" battery included.

..... **48025-PS** \$19.99 ea.

Time Tracker® Visual Timer & Clock

Features 180° viewing and a large, easy to read LCD display. Alarms from 1 sec to 24 hours. Allows quick programming of three colored lights (red, yellow and green) that alert children to time remaining. Can be customized to suit your needs. Includes two LR44 back-up batteries. Requires four "AAA" batteries

8" x 4" **16057-PS** \$39.99 ea.



Tally Counter

The easy to use tally counter goes up to 9999 with the simple push of a button. Use during fitness testing, training and relay races.

..... **48022-PS** \$4.99 ea.



Circuit Stations

NEW!

Agility Spot Challenge Mat™

The Challenge Mat includes an activity guide that walks students through how to perform different routines, hopping from spot to spot. This builds foot speed, and helps improve balance and agility. It also strengthens tendons and muscles in the ankles and knees. Measures 48"L x 36"W.

.....17398-PS \$149.99 ea.

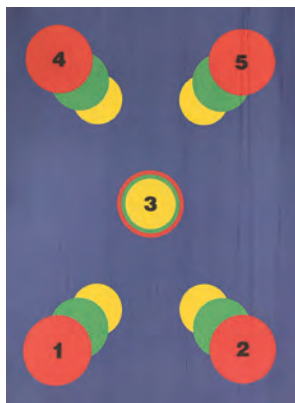

NEW!

Burpee Challenge Mat™

An exceptional addition to any fitness station, the various colored foot and hand sets help guide students through various whole-body routines. The routines range from easy to very difficult and are organized by the included activity guide. Measures 70"L x 48"W.

.....17399-PS \$159.99 ea.



Tire Cross Challenge

Left and right hand marked in opposing colors show users where to travel around the mat. Variations of basic movements create several levels of difficulty. Multiple users can be on the mat at the same time. Includes progression sheet. Non-slip mat measures 60" in diameter with an 18" diameter middle opening.

.....X16843-PS \$124.99 ea.

Snake Cross Challenge™

Students will start in a push-up position with their hands on the first set of hands near the snake's head. They then will move across the length of the snake's body using the handprints as a guide. Great for plank exercises, body positioning changes and pushups. Ideal for multiple users. Non-slip mat measures 10'L x 18"W.

.....16842-PS \$155.99 ea.

NEW!



Playout: The Game of Fitness

The 52 card deck contains 30 bodyweight exercises (upper, lower & core), 10 stretches, 6 WildCard challenges, and 6 MiniGame competitions for variety, adaptability, and fun. Teams compete to earn the most points by completing more difficult challenges. Cards are printed with easy, medium and hard versions of each challenge, along with directions and tips. Deluxe Edition includes large 4" x 6" cards, with dividers, in a hard box. Standard edition includes 2.5" x 3.5" cards and instructions.

Deluxe Edition.....54357-PS \$29.99 pk.
Standard Edition.....54354-PS \$19.99 pk.



FitDeck™ Exercise Cards

These fitness oriented decks provide simple to use, easy to learn, convenient and fun activities for a variety of ages, skill and exertion levels! For individual, group or station workouts, use as a warm up or complete, total body workout session. 56 card set.

Bodyweight FitDeck™.....52516-PS \$14.99 set
FitDeck™ Jr.....52515-PS \$14.99 set



Dr. Curt Hinson's Circuit Training Curriculum

Large images show the exercise with printed instructions of the movement. Station cards are laminated and measure approximately 8.5"W x 11.25"H. Pyramids are made from lightweight, durable corrugated plastic with easy slot and tab assembly. Stand 18" high with a 9.75" wide base. Collapsible and fold flat for storage. Station Cards and Pyramids sold separately. Station Cards are sold in set of 6 and are available in basic, advanced and aerobic.

Set of 6 Rainbow Pyramid Set	X53999-PS	\$66.99 Set	Dynamic Flexibility #253828-PS	\$29.99 Set
Basic Fitness #153275-PS	\$29.99 Set	Balance #153829-PS	\$29.99 Set
Basic Fitness #253276-PS	\$29.99 Set	Balance #253830-PS	\$29.99 Set
Advanced Fitness #153277-PS	\$29.99 Set	Abdominal #153416-PS	\$29.99 Set
Advanced Fitness #253278-PS	\$29.99 Set	Abdominal #253417-PS	\$29.99 Set
Aerobic Circuit #253280-PS	\$29.99 Set	Flexibility #153418-PS	\$29.99 Set
Basic Core #153825-PS	\$29.99 Set	Flexibility #253419-PS	\$29.99 Set
Basic Core #253826-PS	\$29.99 Set	Plyometrics #153420-PS	\$29.99 Set
Dynamic Flexibility #153827-PS	\$29.99 Set	Plyometrics #253421-PS	\$29.99 Set

21138-PS Core Exercise	21141-PS Medicine Ball	21140-PS Exercise Ball	21118-PS Calisthenics
21148-PS Muscle Group	21137-PS Tubing	21171-PS Cardio	21139-PS Jump Rope

HotSpots™

Each spot has a detailed explanation of how to perform drills with supporting graphics that won't scuff or tear! Just spread them out and your stations are set. Includes 12 HotSpots™ and activity guide. Measure 8.5" in diameter Specify Style. \$44.99 ea.

Station Pack

Contents:

- 2 sets 21205
- 6 white boards & 6 holders
- 12 ea. 21027
- 12" orange plastic cones
- 1 set 21025
- 36 Half Cone Class pack



. **.21207-PS** \$119.97 pk.

NEW!



Playout Fitness Station Cards

Enlarged visuals let players know their next exercise at a glance. Choose from regular or junior versions. The regular set includes 30 cards—10 upper, 10 core and 10 lower bodyweight exercises. Each card offers options for easy, medium or hard. The junior set includes 17 cards designed for students ages 2-7. Each card has an exercise along with fun sayings or words of encouragement.

Station Cards 30 Pack54352-PS	\$29.99 pk.
Jr. Station Cards 17 Pack54353-PS	\$19.99 pk.

Station Board Holders

Designed with a slotted top to hold signage, the convenient 6" tall holders fit atop most cones. Create your own signs using the 11" x 8.5" dry erase boards. Sold separately or purchase as a set.



Set of 6 White Board Holder21201-PS	\$14.97 set
White Boards Set of 621202-PS	\$15.97 set
Pack- 6 White Boards & 6 Holders21205-PS	\$35.97 set

Circuit Stations



Exer-Dice

Lunges, push-ups, bicycle, crab kicks, jumping jacks and more. Dice are made from firm foam with a durable vinyl cover. They measure 6.25" high. Sold in a set of 6 or individually in assorted colors.

- Set of 6**.16982-PS** \$99.97 set
- Individual Exer-Dice Assorted Colors**.17146-PS** \$18.97 ea.



Pocket Cubes

Use for repetition markers, quick quizzes, station activities, field day and more! These 6" cubes are poly filled with a vinyl covering and have clear, thick pockets that will hold a 5.75"L x 5.25"H piece of paper. One of each color: red, orange, yellow, green, blue and purple.

- Set of 6**.16981-PS** \$48.99 set



Skillastics™

Keeps up to 100 students moving with 26 exercises and activities.

- Fitness- Grades 1st-8th**.52233-PS** \$299.99 set
- Xtreme Fitness- Grades 6th-12th**.52512-PS** \$229.99 set
- Let's Move In School™**.16069-PS** \$299.99 set



The ZONE Exer-Dice Packs

Divide classes into 6 color groups for easy warm ups and cool downs! Pack includes 6 Exer-Dice and 6 20 Sided Dice. Exer-Dice Mini pack includes: 1 Exer-Dice and 1 20 Sided Dice in assorted colors.

- Exer-Dice Pack- 6 of each dice**.66701-PS** \$114.97 pk.
- Exer-Dice Mini Pack**.66735-PS** \$21.97 pr.



The ZONE 20 Sided Dice

Made from durable polyurethane with molded in numbers that won't wear down. 6" tall.

- Set of 6**.16161-PS** \$34.99 set

The ZONE Exer-Dice Xtreme

Soft sided foam workout dice has 12 sides, each with a different exercise and rep count. Roll options include: burpees, walking lunges, pushups, air squats, tricep dips, planks, Russian twists, wall sits, jumping jacks, crunches and lunges. 6" diameter.



- Single Dice**.16781-PS** \$15.97 ea.
- Set of 6**.66769-PS** \$109.97 set



Fitness Dice

These poly-filled 4" x 4" vinyl covered dice will make exercising more fun. One die has numbers and the other has different exercises. Sold in pairs.

-**.15016-PS** \$10.97 pr.



Sports Health™ Ball & Stick Pack

The 25" stability ball has feet to keep the ball from rolling away! Play some music and have your class keep the beat for a great cardio workout. Drumsticks are 16" long wood sticks. Pack includes: 24 balls and 24 pairs of drumsticks.

Ball & Stick Pack	66742-PS	\$449.99 pk.
16" Drumsticks - 6 Pairs	17230-PS	\$24.99 pk.

NEW!



Smart Fitness Elite Storage Tower

The Smart system consists of an array of products with self-guided workouts printed directly on them. This is perfect for maintaining proper form and moving quickly from one exercise to another. Complete circuits in less time and with less space. Setup dimensions: 70"W x 30"D x 97"H.

Elite Package includes:

- (1) Elite Storage Tower
- (6) 16mm Smart Exercise Mats
- (4) Smart Recovery Foam Rollers
- (1) 4lb., (1) 10lb., (1) 15lb. Smart Medicine Balls
- (2) 6lb., (2) 8lb. Smart Medicine Balls
- (1) 55cm, (1) 65cm, (1) 75cm Smart Stability Balls
- (2) Smart Speed Jump Ropes
- 1 each – Extra Light, Light, Medium, Heavy & Extra Heavy Smart Guard Sleeved Resistance Cables
- 1 each – Light, Medium & Heavy Mini-Bands

Elite Package	29574-PS	\$2,540.00 pkg.
Elite Tower (only)	29575-PS	\$1,495.00 ea.



Smart Fitness Deluxe Storage Tower

The versatility of this tower allows facilities to properly display and store all the key self-guided products available for the end user in a space efficient manner. Setup dimensions: 68"W x 25"D x 74"H. Deluxe Package includes:

- 1 Storage Tower
- 2 Exercise Mats
- 2 Rollers
- (1) 4 lb, (2) 6 lb, (2) 8 lb, and (1) 10 lb Medicine Ball
- (1) 55cm, (1) 65cm, and (1) 75cm Stability Balls
- (1) 20 lb, 30 lb, 50 lb, 70 lb, and 90 lb Resistance Cables
- 5 pairs Quick Switch Handles

Deluxe Package	16461-PS	\$1,670.00 pkg.
Deluxe Tower (only)	16460-PS	\$1,050.00 ea.

Smart Fitness Economy Storage Tower

The tower also features a clip to hang extra resistance cables, bands and/or jump ropes. The Complete Economy Package includes:

- 1 Economy Storage Tower
- (1) 4 lb, (1) 6 lb, (1) 8 lb and (1) 10 lb Med Balls
- (1) 55cm and (1) 65cm Stability Balls

Economy Package	16463-PS	\$599.00 pkg.
Economy Tower (only)	16462-PS	\$349.00 ea.



Mats



Sports Health™ Foam Exercise Mat

Our best value- soft material can be rolled or stacked flat for storage. Memory foam allows them to lay flat for a comfortable workout. Single blue mat is made from a dense .5 thick foam and is available in a Class Pack of 30 mats. The Set of 6 mats are 3/8" thick.

Blue Mat only, measures 48"L x 24"W . . .	X39059-PS	\$14.97 ea.
Class Pack, 30 mats	X29147-PS	\$429.97 pk.
Set of 6, 48"L x 24"W	16774-PS	\$138.99 set



Aeromat™ Workout Mats

Made of easy to clean Phthalate and PVC free closed cell foam. Lightweight, rolls up for storage and is ideal for any floor exercise.

Blue 48"L x 20"W x 1/2" Thick	X29533-PS	\$19.99 ea.
Red 48"L x 20"W x 1/2" Thick	X29534-PS	\$19.99 ea.
Black 48"L x 20"W x 1/2" Thick	X29535-PS	\$19.99 ea.
Green 48"L x 20"W x 1/2" Thick	X29536-PS	\$19.99 ea.
Green 56"L x 23"W x 1/2" Thick	X29537-PS	\$24.99 ea.
Blue 72"L x 23"W x 1/2" Thick.	X29538-PS	\$29.99 ea.
Wall Rack Holds 10 mats		
For 20" Wide Mats	51093-PS	\$25.99 ea.
For 23" Wide Mats.	51094-PS	\$25.99 ea.



Jasmine Fitness Padded Exercise Mat

Superb cushioning with closed cell compressed foam provides a non-slip grip. Lightweight and easy to clean and roll up. Includes carry strap.

72"L x 22"W x 5/8" Thick		
Single Mat	X29459-PS	\$21.99 ea.
10 Pack	X66816-PS	\$209.99 pk.



Sports Health™ Flat Exercise Mat

Easy to clean workout mat is constructed of high density PE foam, with firm top and bottom layers that repels moisture. Easily wipes clean. Convenient handle cutout. Color: blue.

48"L x 24"W x .75" Thick		
Single Mat	X29153-PS	\$15.99 ea.
30 ct. Class Pack	X29154-PS	\$449.97 pk.



SPRI® Exercise Mats

This durable 3/8" thick poly foam mat is perfect for any floor exercise program. Easy to roll up with convenient carry handle.

48" x 20"W x .5" Thick		
Black	X29527-PS	\$21.99 ea.
Blue	X29528-PS	\$21.99 ea.
Black 30 Mat Pack	X29531-PS	\$569.99 pk.
Blue 30 Mat Pack	X29532-PS	\$569.99 pk.



Sports Health™ Curl Up Assessment Mats

Allows students to maintain proper form. Mat is made from 1/2" thick closed cell foam with vinyl cover and glued in lines at both ends. One end features 3" lines the other end measures 4.5".

48"L x 24"W		
Assorted Colors	25187-PS	\$27.97 ea.
Set of 6	25183-PS	\$159.97 pk.





Element Fitness 2" Folding Mats

Easy to clean with a non-absorbent cover over high density foam. Heavy duty stitched seams and handle for transport. Folds for storage.

4'L x 2'W	X29451-PS	\$49.99 ea.
6'L x 2'W	X29452-PS	\$74.99 ea.
6'L x 4'W	X29454-PS	\$124.99 ea.

NEW!



Troy Barbell Trifold Exercise Mat

The Trifold's 1.5" thick padding provides comfortable support while its durable vinyl covering is easy to clean. Built-in handles make transport easy. 72"L x 24"W x 1.5"H, 8 lbs.

Single Mat	X54350-PS	\$43.99 ea.
6 Pack	X66817-PS	\$229.99 pk.



Vinyl Folding Exercise Mat

A basic vinyl mat with three folds and a .625" thick foam center.

46" x 20"	X29010-PS	\$11.99 ea.
-----------------	------------------	-------------



Everlast Folding Exercise Mat

Non-absorbent shell with sewn in handle for easy transport. 1 1/8" foam core for support and comfort. Folds for storage. Black.

6'L x 2'W		
Single	X29557-PS	\$59.99 ea.
6 Pack	X29558-PS	\$339.99 pk.



Smart Mat™

Mat with easy to follow exercises and stretches on both sides. Includes grommets for hanging. Blue.

6'L x 2'W, 16mm Thick		
Blue Smart Mat.29443-PS	\$54.99 ea.
10 Mat Pack with Rack29444-PS	\$599.00 pk.
Wall Rack only29460-PS	\$116.00 ea.

NEW!



GOFIT® Guide Mat

Includes 24 warm-up, calisthenics, and recovery exercises. The mat is double-cushioned, closed cell foam with a non-slip surface for extra comfort and protection. Natural rubber & TPE.

72"L x 24"W, 7mm Thick54351-PS	\$32.99 ea.
------------------------------	------------------	-------------

Yoga

Advanced Pack



Advanced Pack

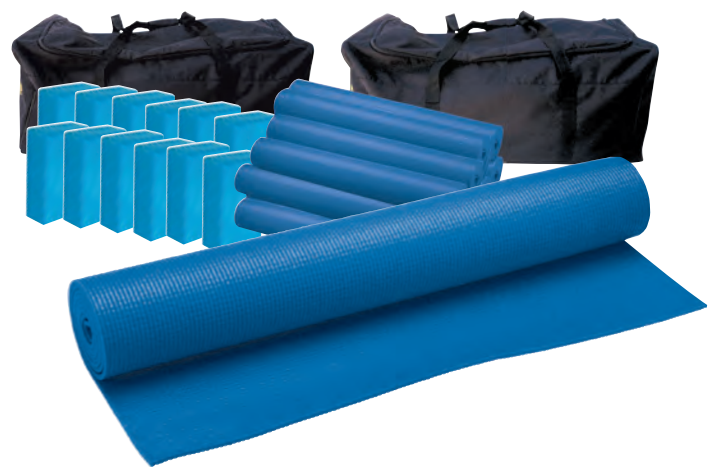

Sports Health™ .125" Basic Yoga Mat

It provides the traction and firm surface that you need to perform at your very best. Made of highly durable closed cell vinyl foam with embedded fabric mesh, the mat will withstand heavy use. Lead free.

68"L x 24"W x .125" Thick

Single.....	.29027-PS	\$12.97 ea.
Basic Pack: 12 Mats & 2 Bags.....	.66176-PS	\$197.97 pk.
Advanced Pack: 12 Mats, 12 Blocks & 2 Bags66177-PS	\$292.97 pk.

Sports Health™ Deluxe .25" Yoga Mat

Textured, non-slip surface. Made of highly durable closed cell vinyl foam with embedded fabric mesh, the mat will perform at a high level for many years. Lead free.

74"L x 24"W, .25" Thick

Single.....	.52039-PS	\$17.97 ea.
Basic Pack: 12 Mats & 2 Bags66178-PS	\$249.97 pk.
Advanced Pack: 12 Mats, 12 blocks, & 2 Bags66179-PS	\$329.97 pk.

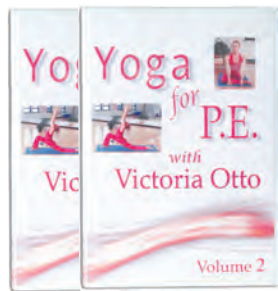

Yoga for P.E.

Part 1 introduces 20 poses. The instructor is able to click on each individual pose or view them all together. Part 2 combines all of the poses for a traditional 25 minute workout.

Volume 1 96 minutes39185-PS	\$25.99 ea.
Volume 2 40 minutes39193-PS	\$25.99 ea.

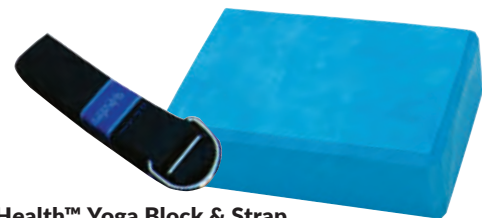

Sports Health™ Yoga Block & Strap

Use for hand and back support, easy to manipulate in any position. Firm foam covered block measures 3" x 6" x 9". Strap is made 100% cotton with an easy loop style buckle. Use to increase flexibility and allows you to grasp and reach limbs to increase stretching.

Yoga Block.....	.52040-PS	\$5.99 ea.
Yoga Strap52041-PS	\$5.79 ea.
Block and Strap Pack: 10 of each.....	.54031-PS	\$89.97 pk.



Yoga Cards

Organized by color for easy, intermediate or challenging poses, this set of 16 cards have a photo on the front of a child in a pose and on the reverse side are illustrated instructions. Heavy duty 8.5"W x 11"L cards with instructions, sample routines and activity ideas. Ages 4 years+.

Set of 16.....	.52886-PS	\$24.99 set
----------------	------------------	-------------

Not made with Natural Rubber Latex.



HotSpots®

Won't scuff or tear and the anti-slip material keeps the spots where you put them! Sets display 12 classic poses and movements for Yoga and Pilates. Includes an activity guide. Spots measure 8.5" in diameter.

Pilates Set21134-PS	\$44.99 set
Yoga Set21135-PS	\$44.99 set

Advanced Pack



Aeromat™ .125" Yoga Mat

Made from Phthalates free PVC closed cell foam with a sticky surface.

68"L x 24"W x .125" Thick

Blue	X54112-PS	\$19.99 ea.
Purple	X54113-PS	\$19.99 ea.
Basic Pack: 12 Blue Mats & Bag66510-PS	\$269.99 pk.
Advanced Pack: 12 Mats, 12 blocks, & 2 Bags66511-PS	\$339.99 pk.

NEW!



Wai Lana School Yoga Kit

Each kit comes with 12 kid-sized yoga mats printed with fun cartoon patterns. They are free of latex, phthalates, phenols, dioxins and furans. The non-slip surface makes them safe for children. Durable and washable. Measures: 60"L x 24"W x 1/8" thick. Also includes: 12 mat bags, Little Yogis™ DVD (30 min.), Little Yogis™ poster (21 poses), set of fun stickers.

.....	54349-PS	\$319.99 kit
-------	-----------------	--------------

NEW!



GOFIT® Yoga Mat

Mat has a cushioned, airy surface, providing comfort and protection during yoga poses or Pilates mat work. Wipes clean with a dampcloth.

68"L x 24"W

Single Blue	54348-PS	\$19.99 ea.
12 Pack Blue66815-PS	\$229.99 ea.
Single Gray	54355-PS	\$19.99 ea.
12 Pack Gray66820-PS	\$229.99 ea.
Single Pink	54356-PS	\$19.99 ea.
12 Pack Pink66821-PS	\$229.99 ea.



Aeromat™ Elite .25" Yoga Mat

Built-in mesh offers anti-stretch capability. Comes with carrying harness. Made with a PVC material, free of latex and phthalates. Packs include 12 lightweight yoga blocks that measure 3" x 6" x 9".

72"L x 24"W x .25" Thick

Teal	X54359-PS	\$23.99 ea.
Pastel Purple	X54360-PS	\$23.99 ea.
Teal Pack: 12 Mats & 12 Blocks	X66822-PS	\$274.99 pk.
Purple Pack: 12 Mats & 12 Blocks	X66823-PS	\$274.99 pk.



Wall Mount Adjustable Mat Rack

Designed to hold up to 10 exercise or yoga mats with grommets. Maximum weight capacity is 66 lbs. Includes hardware.

.....	X16773-PS	\$29.99 ea.
-------	------------------	-------------



Adjustable Mat Rack

For hanging grommetted exercise or yoga mats up to 74" long. Steel construction with casters for transport. Dual side hangers hold up to 10 mats. Some assembly required.

78" x 24"	X16770-PS	\$199.99 ea.
-----------	------------------	--------------



Small Portable Mat Rack

Steel construction with non-marking casters. Rack measures 44"L x 34"W x 27"H and can store up to 40—1/2" thick mats or up to 25—3/4" thick mats.

.....	X16771-PS	\$183.99 ea.
-------	------------------	--------------



Large Portable Mat Rack

Steel construction with non-marking casters. Rack measures 39"L x 47"W x 283/4"H and can hold up to 100—1/8" thick mats or 50—1/4" thick mats.

.....	X16772-PS	\$203.99 ea.
-------	------------------	--------------

Assessment



iLive Wireless Activity Tracker

- Measures heart rate
 - Pedometer distance and calorie count
 - Sleep tracker
 - Bluetooth wireless
 - DC battery power with rechargeable battery
 - Compatible with Android 4.4 or above & iOS 7.1 or above
 - Caller ID, Message notification & Call alert
- **25978-PS** \$59.99 ea.



Ultrak Pulsemeter Watch

- Finger touch pulse testing
- Stopwatch with split time
- Exercise counter with auto and manual calorie counter
- Time, alarm & calendar
- Water resistant

Ultrak Pulsemeter . . . **16151-PS** \$27.99 ea.
 6 Pk. w/Plastic case **16152-PS** \$199.99 pk.
 12 Pk. w/Alum. case **16153-PS** \$388.99 pk.



Ekho® WMP-89™

- Current and average HR
- % of max HR
- Max HR during exercise
- Calorie counter
- Stopwatch, date, time
- Meets NASPE standards

Ekho WMP-88 **25301-PS** \$69.99 ea.
 6 Pk. w/Plastic Case **25303-PS** \$419.99 set
 12 Pk. w/Alum. Case **25304-PS** \$799.99 set



InstaPulse™ Monitors

The hand-held design of this monitor takes the complication out of finding your heart rate. Just grab with both hands and your rate appears in less than one minute. Accurate to within one beat per minute. The silver edition is water and weatherproof. It can be used in pool environments. The gold edition is water resistant and comes in four models—7 inch, 11 inch, wall mount or floor stand. Optional storage case holds six 7" batons or four 11" batons. Requires (1) 9V battery (included).

7" Silver Monitor **.25988-PS** \$129.99 ea.
 7" Gold Monitor **.25055-PS** \$129.99 ea.
 11" Gold Monitor **.25040-PS** \$137.99 ea.
 Wall Mount with Monitor. **X25041-PS** \$296.99 ea.
 Floor Stand with Monitor. **X25042-PS** \$279.99 ea.
 Storage Case 15"L x 10"W. **.25215-PS** \$49.99 ea.



Aluminum Storage Case

Pre-cut foam allows you to safely store up to 30 heart rate monitors with plenty of room for straps and other accessories. Lockable case measures

15"L x 17.5"W x 9.75"H. **.25200-PS** \$99.99 ea.



Replacement Pedometer Batteries

Easy to replace, we offer these batteries to you at great prices! The 25103 is universal for most pedometers.

LR44 **25103-PS** \$0.87 ea.
 LR 43 & L1142. . . **25135-PS** \$0.87 ea.
 LR1130 **25947-PS** \$0.87 ea.



WARNING: CHOKING HAZARD.
 Small parts. Not for children under 3 yrs.

Plastic Storage Case

Durable hard plastic case stores 15 pedometers, straps and tokens.

. **25156-PS** \$8.99 ea.





Sports Health Modified Pull-Up Bar

Ideal for training for the Fitnessgram® modified pull-up test. Made of strong, but lightweight steel. Adjust to 8 different height settings—from 20" to 34"H. Bar features a rubber, no-slip, comfort grip for safety. Attached red strap marks "official" pull-up height. Assembles without tools.

.....**.25899-PS** \$249.99 ea.



Sports Health™ Push-Up Mat

This double sided mat uses strategically placed palm markings and an adjustable soft foam chest block to teach proper hand placement and body positioning for an accurate push-up. Removable foam block attaches with Velcro® to adjust from 3" to 6". Made of phalate free PVC.

30.5" x 19"

Single.....**.25981-PS** \$31.97 ea.

Set of 6.....**.25982-PS** \$184.97 set

Standard

Deluxe



Baseline® Sit n' Reach® Flex Tester

This tester works with fitness programs such as the Presidential Physical Fitness Test, FitnessGram®, YMCA and SHAPE. Top scale is clearly marked in inches and centimeters. Designed with built-in footplate and maximum stretch indicator. The Deluxe Flex Tester offers an adjustable start point that can be used to normalize scores to account for variation in arm and leg length of the person tested.

Standard, 21"L x 13"W x 12"H.....**.25018-PS** \$114.97 ea.

Deluxe, 30"L x 13"W x 12"H.....**.16749-PS** \$179.97 ea.

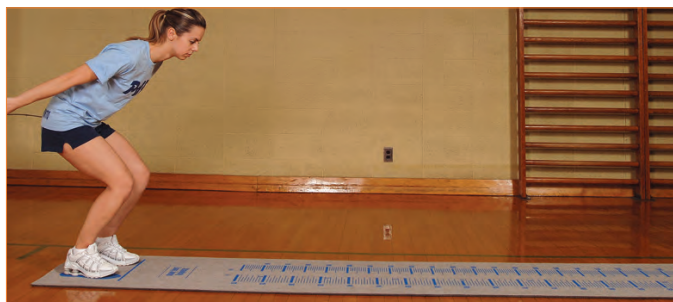

Deluxe Standing Long Jump Test Mat

A high quality non-slip, rubber mat with measurements in centimeters and inches for testing the standing long jump. Will not tear or wrinkle and is puncture resistant. Provides excellent grip at take off and cushions landings. Weighs 45 lbs.; rolls for storage. Includes a complete manual with norms for various skill levels.

144"L x 22"W, ¼" Thick.....**X25010-PS** \$285.99 ea.

Vertical Challenger

Telescopes to measure vertical jump from 4 to 12 feet. Moveable arms are placed at 1" increments to allow for accurate measurements. Heavy duty base has easy glide casters for transport. Frame is made from powder coated steel and includes the 22 lb. stability weight.

.....**X52973-PS** \$394.99 ea.



Audio



Amplivox Fitness Package with Transmitter

Includes a waterproof microphone headset, a wireless 16 channel UHF bodypack transmitter and wireless transmitter fitness belt. The neoprene beltpack secures around the wireless transmitter in a pouch around the waist. Headset has rugged cable and connector with flexible gooseneck design.

.....54280-PS \$279.99 pk.



Hamilton Buhl® Bluetooth Cordless Cube Speaker

Compatible with Bluetooth-enabled devices or via the 3.5 mm audio input. The Bluetooth range is 32'–49'. Rechargeable battery runs up to 6 hrs. and charges via micro USB charger (included).

4"W x 2"H x 1.25"D54341-PS \$39.99 ea.

iLive® Bluetooth Tower Speaker w/ Remote

Features bluetooth wireless up to 60', supports profile A2DP, 2-channel stereo sound, built-in stereo speakers, aux in (3.5mm audio input), RCA stereo audio inputs, digital volume control, AC power input. Includes: remote control (requires a CR2025 battery (preinstalled), RCA stereo audio cable, AC/DC power adapter, warranty, user's guide.



..... 54330-PS \$67.99 ea.

iLive® Wireless Speaker

Built-in handle and rechargeable battery. Dual 4" full range speakers with Micro-USB port for recharge. LED function indicator, bass, treble and volume controls and 3.5mm Aux in.

18.35" x 7.48" x 9.45", 4.34 lbs.

..... 53048-PS \$51.99 ea.



iLive® Alexa™ Enabled Wireless Fabric Speaker

Use voice commands to bring fun into the class and get everyone involved. Features Wi-Fi, multi-room play, 3.5mm aux input, micro USB port, play and pause & pairing button, digital volume control and LED light ring. Wireless range is 33 ft. and Bluetooth range is 98 ft. Rechargeable Li-Ion battery gives you up to 5 hours of playtime. Includes iLive app, 3.5mm audio cable, micro USB to USB cable, user's guide.



8.06"W x 3.94"H x 3.94"D 54331-PS \$99.99 ea.

Bose® SoundTouch® 30 Series III Wireless Music System

It uses exclusive waveguide technology engineered around a high-performance woofer to produce deep, rich sound. Displays in-depth song, artist, station and connectivity information on an OLED screen. Includes auxiliary and USB inputs, USB and Ethernet port and 6 preset buttons. Includes power cable, USB cable, and remote control.

17.1"W x 9.7"H x 7.1"D, 25 lbs.

..... X53944-PS \$999.99 ea.



Bose® SoundTouch® 10 Wireless Music System

Stream music through music services like Spotify, Pandora, iHeartRadio and more. Includes auxiliary and USB inputs and 6 preset buttons. Includes power cable, USB cable and remote control.

5.56"W x 8.34" H x 3.43"D, 2.89 lbs.

..... 53596-PS \$289.99 ea.



iLive® Bluetooth System

Features 2.1 channel stereo sound, subwoofer for enhanced sound, bass and treble controls, Ambient blue LED light effects and a wireless range of 33 feet. The subwoofer produces deep bass and works together with the stereo speakers to produce dynamic sound. Includes a built in amplifier and a 3.5mm to RCA audio cable.

12"Lx 10.7"W x 8.8"H, 7 lbs.

..... 53047-PS \$61.99 ea.



Hydration & Nutrition



Disposable Cups & Dispensers	198
Bottles, Ice Chest, Coolers, Towels & Cooler Carts	199-200
Sideline Carts.....	201
Hydration Systems	202-205

Nutrition	206-216
Hydration Packages	207
Heat Relief	217
Hydration Testing	218

Disposable Cups & Dispensers



Buy a case and SAVE!

Buy a case and SAVE!

PAPER CUPS	Tube	Case
A. 3 oz. Flat Bottom Paper Cup	21209 100/tube \$5.70 tb.	1030741 5,000/case \$253.50 cs.
B. 3½ oz. Pleated Paper Cup	21013 100/tube \$4.62 tb.	1030749 2,500/case \$105.00 cs.
C. 4¼ oz. Cone-Shaped Paper Cup	21011 200/tube \$5.77 tb.	21399 5,000/case \$120.50 cs.
D. 5 oz. Flat Bottom Paper Cup	21010 100/tube \$6.50 tb.	1030649 2,500/case \$134.00 cs.
E. 7 oz. Gatorade® Paper Cup	21696 100/tube \$9.16 tb.	1030852 2,000/case \$130.00 cs.
F. 12 oz. Gatorade® Paper Cup	21100 100/tube \$9.31 tb.	21092 2,500 case \$162.50 cs.
G. 9 oz. Powerade® Paper Cup	1007042 100/tube \$6.75 tb.	21647 2,500 case \$110.00 cs.

PLASTIC CUPS	Tube	Case
J. 5 oz. Flat Bottom Plastic Cup	21012 100/tube \$4.22 tb.	1030644 2,500/case \$91.35 cs.
K. 5 oz. Yellow Plastic Cup	21233 100/tube \$5.69 tb.	21402 1,000/case \$46.25 cs.
L. 5 oz. Blue Plastic Cup	21231 100/tube \$5.69 tb.	21403 1,000/case \$46.25 cs.
M. 5 oz. Mauve Plastic Cup	21232 100/tube \$5.69 tb.	21404 1,000/case \$46.25 cs.
N. 5 oz. White Plastic Cup	21417 100/tube \$5.69 tb.	21407 1,000/case \$46.25 cs.
O. 3½ oz. Flat Bottom, Clear Plastic Cup	21418 100/tube \$4.13 tb.	1030643 2,500/case \$88.80 cs.

MEDICINE CUPS	Tube	Case
H. 1 oz. Pleated Paper Medicine Cup	21095 250/tube \$4.86 tb.	21405 5,000/case \$85.70 cs.
I. 1 oz. Plastic Medicine Cup Measures oz., mL., grams, T, tsp, and cc's.	21004 100/tube \$2.05 tb.	1030744 5,000/case \$91.60 cs.

Cup Dispensers

P. Standard—Adjusts to fit paper and plastic cups on this page (excluding E, F, G, H, and specimen containers).

.....21000 \$29.00 ea.

Q. Stainless Steel—Adjusts to fit paper and plastic cups on this page (excluding E, F, G, H, 21417, 21418, and specimen containers).

.....21210 \$42.50 ea.

Bottles, Ice Chest, Coolers, Towels, & Cooler Carts



Gatorade® Bottles

A. Pressure Flow Top
32 oz. **1006062** \$4.99 ea.

B. Gatorade Premium Shaker Bottle
Best for mixing protein powder.
32 oz. **1006061** \$18.99 ea.

C. Gatorade Insulated Bottle
32 oz. **1005775** \$14.99 ea.

D. NEW! Gatorade Stainless Steel Bottle
26 oz. **1034458** \$34.99 ea.

E. Gatorade Bottles with Carrying Racks
Six 33 oz., Pressure Flow Top, wide mouth
Gatorade bottles with plastic rack.

..... **38091** \$49.99 set

Plastic Rack Only (holds six bottles)
..... **38040** \$30.99 ea.

Gatorade® Cooler Cup Racks*
Fits on top of 7 and 10-gallon coolers. Holds 18 8
oz. or 12 oz. Gatorade® cups.

F. Acrylic Cup Rack with Cover (Clear)
..... **38101** \$49.99 ea.

Mixing Whisk

Great for mixing Gatorade powder. Made of
stainless steel.

16"L. **36095** \$26.99 ea.

G. Gatorade® Ice Chests
60-quart capacity, split top opening with
pull up handle and wheels.

26¾"H x 21½"W x 17½"D
..... **38097** \$154.99 ea.

H. 48-Quart Ice Chest
..... **38085** \$75.99 ea.

Gatorade® Coolers
1-Gallon **38083** \$22.99 ea.

3-Gallon **38011** \$70.99 ea.

5-Gallon **38084** \$83.99 ea.

I. 7-Gallon **38012** \$106.99 ea.

J. 10-Gallon **38029** \$126.99 ea.

Replacement Parts for Gatorade Coolers
K. Lid for 7 or 10-Gallon Cooler
..... **38102** \$64.99 ea.

**L. Slanted Clown Face Spigot, Fits All
Gatorade Coolers** ... **38256** \$16.50 ea.

Gatorade® Towels

Heavy-duty white towel featuring the Gatorade®
logo—a must for any sidelines!

40"L x 24"W **48026** \$15.99 ea.

Gatorade® Antimicrobial Towel
M. 40"L x 24"W **48041** \$14.99 ea.

Gatorade® Cooler Carts
Utility shelves and locking wheels.

N. Double Cooler Cart
Holds a 7-gallon cooler and a 3-gallon cooler.
Two cup racks and two side racks included.
40"H x 41"W x 18"D

White **38197** \$759.99 ea.

O. Single Cooler Cart
Holds a 3, 5, 7, or 10-gallon cooler.
One cup rack included.

19"W x 26"D x 37"
..... **1005776** \$634.99 ea.

*See previous page for Gatorade Disposable cups.



**TWO-PART STAND
EASILY DISASSEMBLES
FOR PORTABILITY!**

**EXCLUSIVE
PRODUCT**

SH School Health Brand Portable Cooler Stand

Portable, durable, weatherproof, washable, and collapses easily. Effortless
assembly. Holds 10-gallon cooler, flip it over and it holds a 5 or 7-gallon
cooler. The ideal beverage station.

..... **38122** \$169.99 ea.

Bottles, Ice Chest, Coolers, & Cooler Cart



A. POWERADE® Sports Bottle

Made from soft, low-density plastic with wide mouth cap and our one-way flow valve.

32 oz.....**38490** \$7.49 ea.
100/case..... **1006991** \$654.99 cs.

B. POWERADE® Sports Bottles with Carrying Rack

Includes six 32 fl. oz. sports bottles and carry rack made of heavy-duty plastic with a center handle.

Six 32 oz. Sports Bottles with Carrier **1006992** \$79.99 set
Powerade Carrying Rack Only (holds six bottles) **38492** \$34.99 ea.

POWERADE® Coolers & Ice Chests

- Coolers maintains ice for 3 days at 90°F
- Recessed and angled drip-resistant spigot for easy dispensing
- Seat-top lid provides sitting surface & is stackable

C. 2 Gallon **1006737** \$49.99 ea.
D. 5 Gallon **38488** \$99.99 ea.
E. 10 Gallon **38486** \$139.99 ea.
F. 12-Can Cooler **1006738** \$49.99 ea.
G. 48 qt. Ice Chest... **38485** \$6.99 ea.
H. 110 qt. Wheeled Ice Chest **1006739** \$239.99 ea.

I. 10 Gallon Cup Carrier

10 gallon cooler and holds 9 oz. Powerade cups. **38491** \$74.99 ea.

J. POWERADE® Sideline Cart

This cart features push button expandable legs allowing for two different height settings. Holds two 10 gallon coolers, bottles, and cups (coolers, bottles, and cups sold separately). Two sets of durable caster wheels.

Low Position: 43"L, 20"W, 30"H (with cooler, height is 44"). High Position: 43"L, 20"W, 36"H (with cooler, height is 50"). Weighs 47 lbs. **38495** \$809.99 ea.



A. Waterboy™ Quick Fill Water Bottle with Safety Lid

This water bottle features a specially designed safety lid with patented safety spout, protecting your athletes and staff from the spread of germs. Treated with a health-care-grade anti-microbial for additional protection.

B. Waterboy™ Quick Fill Water Bottle
32 oz.....***38151** \$13.99 ea.

Cramer® Polyethylene Drinking Bottles and Wire Carrier

C. Push-pull top, wide mouth bottle.
32 oz.....**38003** \$2.99 ea.
D. Wire Rack (holds six bottles) **38004** \$18.99 ea.
E. Cramer® Collapsible Bottle Carrier
Plastic carrier holds six quart-sized squeeze bottles. Collapses flat for easy storage. **90532** \$28.99 ea.

Mueller® 32 oz. Water Bottles

Sure Shot Cap
F. Red Cap **1003601** \$10.99 ea.
White Straw Cap
Red Logo **54665** \$4.49 ea.
G. Black Logo **54666** \$4.49 ea.

Mueller® Collapsible Bottle Carrier

Plastic carrier holds six quart-sized squeeze bottles. Collapses flat for easy storage.
H. Black **1003602** \$25.99 ea.
Red..... **1032075** \$17.99 ea.

*Direct-ship item. Please allow additional time to receive.

Gatorade® Insulated Sideline Cart

The Gatorade Sideline Cart is perfect for any sideline, athletic event, or outdoor practice facility. The cart is designed to store equipment and hydration supplies. Two large ice bins with drains allow for the storage of cold drinks that are easily accessible through the hinged vertical door.

Features:

- Roto-tough roto-molded construction
- Four 8" pneumatic caster wheels, two with brakes
- Powder coated steel frame
- Storage cabinet with vertical hinge door
- Butler tray hinges
- Aluminum center lid support frame
- 2 Ice down bins with drains
- Hinged lids on ice bins
- Brass boiler drains

67"L x 33"W x 40"H, 175 lbs. **1005777** \$3,074.99 ea.



Rhino Hydration SuperCart

Features:

- Two athletes can be taped on the cart or one can lie down for lower treatment or assessment
- The top surface is covered with padded easy-to-clean heavy duty vinyl
- Three storage drawers, plus a storage compartment for ice, an AED, and supplies, keeping supplies and equipment organized, dry, and ready to use
- Durable steel frame construction for many years of use
- Heavy duty wheels swivel on one end and lock in place to create a highly mobile cart
- The cart rolls easily on almost any surface, including wet grass; grab handles make for easy lifting
- Locking, foldaway doors protect valuable equipment and supplies while cart is not in use

. **33083** \$4,999.99 ea.

Rhino One-Piece Medical SuperCart

All the great features of the Hydration SuperCart, plus:

- Tough fold-away allows you to extend the cart's dimensions from 4 feet to 6 feet
- A 4' x 2' top surface extends to 6', allowing an athlete to lie down or two athletes to be taped at once
- The cart rolls easily on almost any surface, including wet grass; grab handles make for easy lifting
- Option to add your logo to the cart

. **33082** \$4,389.99 ea.



FREE SHIPPING at SchoolHealth.com/SportsMed
 Get **FREE SHIPPING** on your online order over \$100! Go to the back cover for Free Ship Online code. Can only be used once per customer. Expires 12-31-20.

Hydration Systems



EXCLUSIVE DESIGN!

Adjustable Shelf

Spigot Access

Custom Coozie



SH School Health Brand Horizontal Power System

Exclusively manufactured for School Health by Waterboy Sports, and built on the durable Generation 2 Horizontal Power Model foundation.

- Perfect for sideline hydration station; (coolers not included)
- The wagon is designed to fit through standard doorways and the flat-free caster wheels allow for easier movement, even when full
- The 55-gallon water tank and Power Pac allow the Horizontal Power System complete mobility and can re-hydrate up to eight people simultaneously with the fluid of your choice, water, commercial sports drinks, or your proprietary liquid
- The water tank's 10" top opening makes filling and cleaning easy, while the belly-mounted drain sump allows for more complete emptying for cleaning and storage
- Safety spouts prevent the nozzle from coming into contact with the drinker's mouth, reducing contamination possibilities; all safety spouts are treated with an anti-microbial solution
- Adjustable work shelf that allows coolers (2 x 10 gallon or 3 x 5 gallon) to be transported securely while providing access to the coolers' spigots
- Also available with a School Health Tank Coozie to insulate the tank

SH Horizontal Power System	*38514	\$3,979.99 ea.
SH Horizontal Power System with Coozie (as shown)	*1003611	\$5,559.99 ea.

Custom colors and embroidery available, call for quote.

Waterboy™ Accessories/Parts

Drinking Nozzle	*38186	\$32.99 ea.	Battery Charger	*38233	\$149.99 ea.	Water Pump (12 volt)	*38239	\$229.99 ea.
Sanitary Tablets, 150/Bottle	*38152	\$20.99 ea.	12 Volt/12 Amp Battery	*38234	\$137.99 ea.	Quick Release Brass Coupling	*38240	\$27.99 ea.
Hose Only, 50 ft.	*38150	\$66.99 ea.	Gravity Hose and Nozzle	*38235	\$20.99 ea.	Quick Release Brass Nipple	*38241	\$23.99 ea.
Aluminum Shelf (for VPM Models)	*38228	\$139.99 ea.	Misting Nozzle (for Power/Chiller Models)	*38236	\$58.99 ea.			
2-Wheel Cooler Dolly	*38230	\$374.99 ea.	Switch/Power Pac	*38237	\$24.99 ea.			
Additional Cooler with Quick Release	*38231	\$208.99 ea.						

*Direct-ship item. Please allow additional time to receive.



A



B



C



D

A. Vertical Power Model—23 Gallon

This 23-gallon, fully mobile hydration system can re-hydrate up to six athletes simultaneously. The on-board, battery-operated, on-demand pump provides plenty of pressure for several hours. On a 2-wheel dolly, with flat-free wheels, transports easily and is ready when you are.

.....	*38512	\$2,234.99 ea.
B. Plain Coozie	1006499	\$519.99 ea.
Custom Coozie	1006500	\$654.99 ea.

C. Waterboy™ Horizontal Chiller—30 Gallon

Our most popular system, with six drinking stations, 25 gallon ice chest and four-wheel cart for easy transport. Unit uses push-in fittings on all components, including chilling coil. Hose not included, sold separately below.

Hose, 50 ft.	38150	\$66.99 ea.
-------------------	--------------	-------------

D. Waterboy Repair Kit

The Field Maintenance Kit for multiple units contains the following items in a sturdy and lockable carrying case:

- | | |
|-----------------------------------------------------------|---------------------------------------------|
| (2) Curly hose with nozzle | (2) Stemmed safety spout |
| (1) 150-count bottle of steramine sanitizing tablets | (2) 5-pack of collars and O-rings |
| (1) 2-way manifold | (1) Fitting for the pump and tank |
| (1) 3-way manifold | (1) 3/8" male connector for the tank outlet |
| (1) Reduces inlet of 3-way manifold to accept 3/8" tubing | (2) 3/4" drain cap |

Retail price for the entire kit reflects over a 20% discount from individual item prices!

.....	38225	\$164.99 pkg.
-------	--------------	---------------



A



B



C

A. A-Frame, Eight-Station Drinking Tree

All-aluminum collapsible frame. System has eight drinking stations, with individual shut-offs, plus main water pressure valve. Attaches to hose.

.....	*38154	\$829.99 ea.
-------	---------------	--------------

B. Eight-Station, In-line Drinking Line

Mounts on fence, wall, or any vertical surface. In-line system has eight drinking stations. Aluminum manifold lined with PVC piping. Attaches to hose.

.....	*38156	\$754.99 ea.
-------	---------------	--------------

Waterboy™ Accessories and Parts

C. 10 Gallon Cooler and Manifold	38299	\$396.99 ea.
Tripod Stand	38301	\$934.99 ea.
Lever for Nozzle	38303	\$7.99 ea.
Nozzle Only	38304	\$42.99 ea.

FREE SHIPPING at SchoolHealth.com/SportsMed

Get FREE SHIPPING on your online order over \$100! Go to the back cover for Free Ship Online code. Can only be used once per customer. Expires 12-31-20.

*Direct-ship item. Please allow additional time to receive.

Hydration Systems



A



B



C



D



E

A. Cramer® PowerFlo Pro—20 Gallon

- Features a new, convenient battery charging system -simply plug the charger directly into the cabinet
- Every component is made of an FDA approved material
- Rugged metal hand truck is custom built for the hydration units, with extra reinforcement straps to insure performance and then powder coated to provide increased durability
- External manifold provides easy access to hose attachments to facilitate easier cleaning and winterizing
- Six drinking stations with flexible hoses
- Square tank provides for increased mobility and access through narrow doorways and gates
- The rounded corners allow for easy cleaning of the interior of the tank
- Tankless system available to convert a cooler for the tank
- 10" no-flat wheels

20 Gallon Tank	*1005297	\$1,819.99 ea.
Tankless	*1005296	\$1,554.99 ea.

B. Cramer® PowerFlo® 50™

- Carries up to 50 gallons
- Six drinking stations
- Constructed of FDA approved or water potable materials for the health and safety of athletes
- 9" tank opening to facilitate the use of ice and easy cleaning
- Heavy-duty metal cart with unique anti-tip steering system and 10" pneumatic tires
- Preserves battery life with deluxe charger

.....	*38250	\$2,724.99 ea.
-------	---------------	----------------

C. Cramer® ThermoFlo Max—30 Gallon

Six drinking station unit. Insulated cooler with 120 qt. (30 gallon) ice capacity. Dual 30' (60' total) copper coils for the ultimate in cooling capability. Highest quality hose fittings for the best in dependability. Manifold features heavy duty aluminum supports. Secured with two high quality nylon straps. Not motorized.

.....	*38311	\$1,684.99 ea.
-------	---------------	----------------

Outdoor Boss Drinking Station

12 Volt Self-Contained Drinking System—Auto Shut-off

- The patented BOSS is a completely self-contained, easy to transport, and affordable way to re-hydrate athletes
- Auto-sensing, pressure activated pump shuts off when not in use to conserve battery life
- The system comes complete with four drinking lines, fits 10 or 7 gallon twist top coolers, and includes smart trickle charger
- Water intake is part of the lid, allowing you to purchase the drinker only and use your own 7 or 10 gallon twist top coolers—simply replace your existing lid with Boss lid system
- Each system features 4 drinking stations

D. Lid Assembly Only	38425	\$734.99 ea.
E. Lid Assembly with 10 Gallon Cooler.....	38426	\$819.99 ea.
Collapsible Cart	38504	\$94.99 ea.

Replacement Parts for PowerFlo®

Hose, Set of 4	38104	\$54.99 set	Switch	38295	\$54.99 ea.
Manifold Assembly	38105	\$204.99 ea.	Suction Hose, Braided.....	38297	\$57.99 ea.
Valve, Each.....	38474	\$42.99 ea.	Wiring Harness.....	38298	\$49.99 ea.
Valves, Set of 4.....	38106	\$30.99 set	Clamp with Tube.....	38479	\$66.99 ea.
Battery	38107	\$135.99 ea.	Hose, 6/pkg	38481	\$99.99 pkg.
Pump.....	38108	\$203.99 ea.			

*Direct-ship item. Please allow additional time to receive.

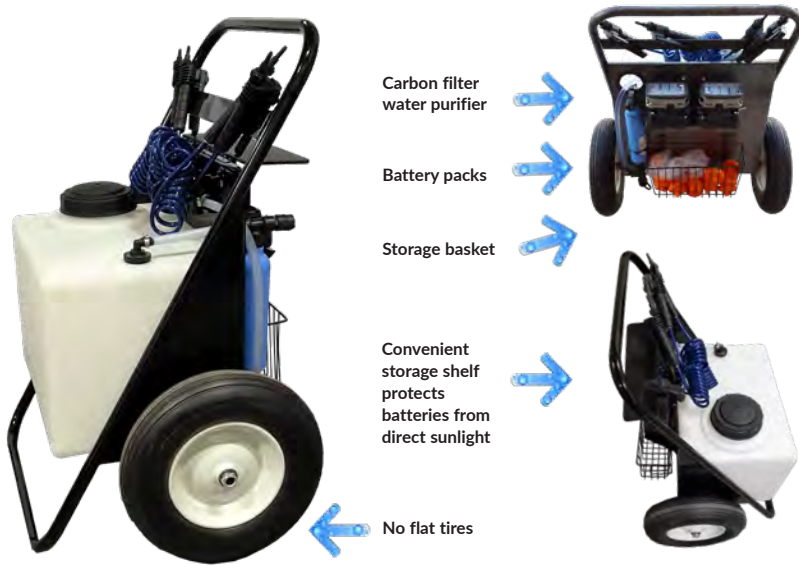

PurePumper 1600—16 Gallon

The Pure Pumpers 16-gallon dolly unit is engineered for maneuverability on turf or grass and can be pushed or pulled with little effort. It is powered by two lithium ion 18 volt batteries that can be easily removed for recharging. It comes with a carbon filter that eliminates taste, color, and smell from the water. Wide mouth opening allows for easy filling and cleaning while a bottom sump drain allows for complete water drainage after use.

Designed to offer a smaller mobile space-saving unit that can be moved very easily and loaded into the back of a yellow bus or storage bay of a commercial bus. Optional customizable kozy available.

Pure Pumper 1600		
.....	1007413	\$1,664.99 ea.
Custom Coozie		
.....	1007490	\$244.99 ea.

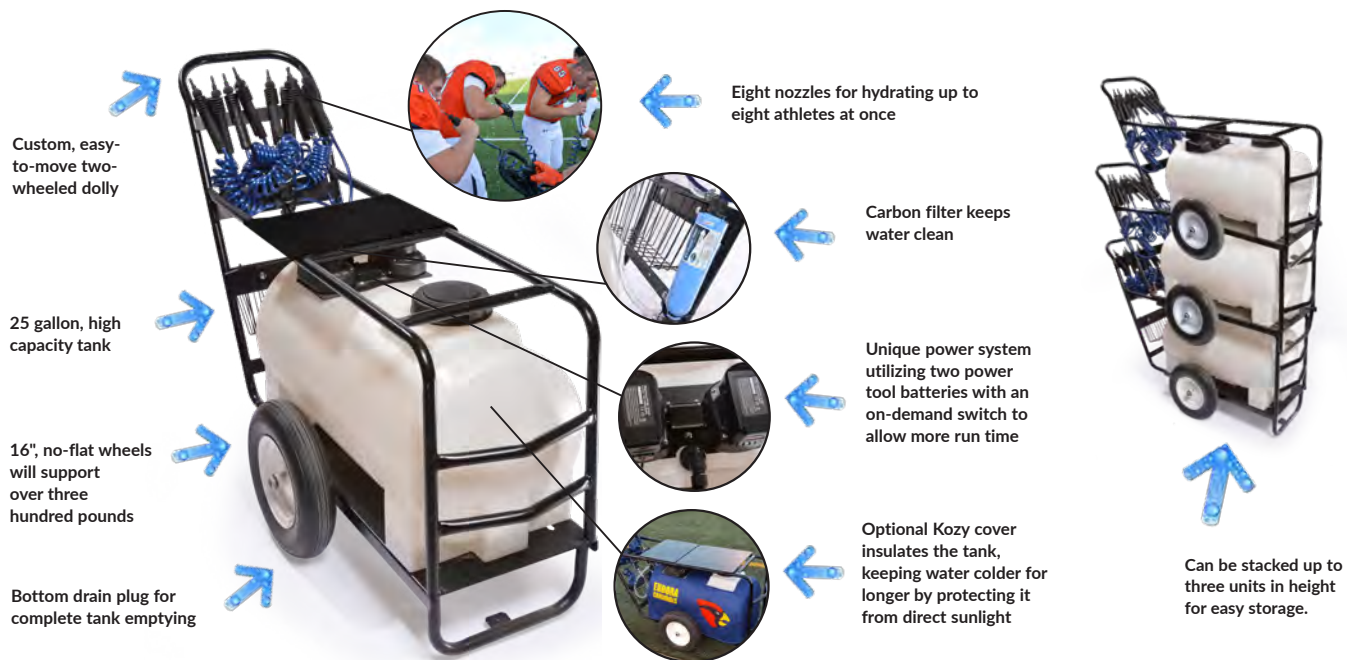

Pure Pumper 2500 Hydration Unit—25 Gallon

The Pure Pumper 2500 is a 25 gallon dolly unit that is engineered for maneuverability on turf or grass and can easily be pushed with little effort. It is powered by 2 lithium 18 volt tool batteries that can be easily removed for recharging. The narrow frame allows it to move through standard door frames and sits on 16"no-flat tires. All units come with a carbon filter that eliminates taste, color, and odor from water. Wide-mouth opening allows for easy filling and cleaning while a bottom sump drain allows for complete water drainage after use. Three units can stack up for convenient storage.

..... ***1005478** \$2,329.99 ea.

Accessories

Custom Coozie	1006487	\$294.99 ea.
Replacement Filter.....	1005565	\$60.99 ea.
Charger.....	1005561	\$104.99 ea.

*Direct-ship item. Please allow additional time to receive.

Nutrition



G ZERO Gatorade

Developed for athletes that prefer a low-sugar, low-calorie alternative. Gatorade Zero has no sugar with the same electrolytes as Gatorade Thirst Quencher. Electrolytes: sodium 270 mg/potassium 75 mg. Carbs: 1-2 g (varies by flavor). Calories: 5-10 (varies by flavor).

32 oz., 12-count

Berry	1034050	\$24.99 ea.
Glacier Cherry	1034048	\$24.99 ea.
Glacier Freeze	1034056	\$24.99 ea.
Lemon Lime	1034046	\$24.99 ea.
Orange	1034047	\$24.99 ea.

20 oz., 24-count

Glacier Cherry	1034045	\$24.99 ea.
Glacier Freeze	1034066	\$24.99 ea.
Lemon Lime	1034043	\$24.99 ea.
Orange	1034044	\$24.99 ea.

20 oz., (3) 8-count

Glacier Cherry	1034053	\$24.99 ea.
Glacier Freeze	1034057	\$24.99 ea.
Lemon Lime	1034051	\$24.99 ea.
Orange	1034052	\$24.99 ea.



Gatorade G2® 02 Perform

A low calorie electrolyte beverage designed to help athletes hydrate when they are off the field so that they will be better prepared for competition on the field. Research indicates that athletes are doing a poor job of hydrating off the field, as some studies have shown that 50 to 70 percent of athletes show up to practices and games inadequately hydrated. Dehydration can have a negative impact on performance and increase the risk for heat illness. With the addition of G2, the Gatorade Company will better meet the hydration needs of athletes 24/7.

Wide Mouth Bottles, 20 oz., 24/case

Grape	38270	\$38.99 cs.
Fruit Punch	38269	\$38.99 cs.
Lemon-Lime	38306	\$38.99 cs.
Glacier Freeze	38468	\$38.99 cs.



G Series Pro Nutrition Shake 01 Prime

Helps elite athletes meet their daily calorie needs to optimize performance. Provides high-quality milk protein isolate, plus 15 vitamins and minerals for muscle metabolism and energy to promote normal muscle adaptation resulting from training.

11 oz. Cans, 24/case

Chocolate	38352	\$63.99 cs.
Vanilla	38024	\$63.99 cs.



Gatorade® 01 Prime

Gatorade Prime 01 is pre-game fuel in a convenient and functional 4-oz. pouch. It is designed to be used in the 15 minutes before exercise to provide energy by maximizing the availability of carbohydrate energy to muscles at the beginning of a workout or competition.

4 oz. Pouch, 20/case

Berry	38312	\$45.99 cs.
Fruit Punch	38313	\$45.99 cs.
Fierce Grape	38455	\$45.99 cs.



Gatorade® Thirst Quencher

For over 40 years, Gatorade has proven it is the best way to keep athletes hydrated and performing at their best. Now part of the G Series as 02 Perform, Original Gatorade still delivers a unique formula of sodium, potassium, and essential carbohydrates to your muscles and mind during the heat of battle. Rehydrate, replenish, and refuel with 02 Perform and maintain your high level of performance when it matters most.

Wide Mouth Bottles, 20 oz., 24/case

Blue Raspberry	38147	\$37.99 cs.
Fruit Punch	38074	\$37.99 cs.
Frost Glacier Freeze	38088	\$37.99 cs.
Lemon-Lime	38072	\$37.99 cs.
Orange	38073	\$37.99 cs.
Frost Riptide Rush	38095	\$37.99 cs.
Grape	38175	\$37.99 cs.

24 oz., 24/case

Rain Berry	1006064	\$63.99 cs.
Lemon Lime	1006065	\$63.99 cs.
Fruit Punch	1006066	\$63.99 cs.
Cool Blue	1006067	\$63.99 cs.
Fierce Grape	1006068	\$63.99 cs.



Choose flavors on Gatorade order form

A. Gatorade Performance High School Performance Package

Includes:

- (6) Cases of Gatorade Prime Energy Chews
- (1) Case of Gatorade Thirst Quencher Powder (yields 84 gallons total)
- (8) Cases of Gatorade Recover® Whey Protein Bars (96 servings)

Plus, Choose Up to Three of These Premiums Below:

- (1) 3 Gallon Cooler
- (1) 7 Gallon Cooler
- (1) 10 Gallon Cooler
- (1) 60 Quart Ice Chest on Wheels
- (10) Gatorade Towels
- (24) Gatorade Contour Bottles
- (4) Gatorade Contour Bottle Carriers
- (1) Case of 7 oz. Cups (2,000/case)

.....*38501 \$235.00 ea.

See program requirements for
Gatorade High School Performance Package on page 208.

B. Create Your Own High School Performance Package

Choose Two of These Options*:

- OPTION #1 – (10) Cases of Gatorade Prime® Energy Chews (160 servings)
- OPTION #2 – (1) Case of Gatorade Thirst Quencher Powder AND (1) Case of 7 oz. cups (yields 84 gallons total)
- OPTION #3 – (10) Cases of Gatorade Recover Protein Shakes (120 servings) OR (10) Cases of Gatorade Recover Super Shake (120 servings)
- OPTION #4 – (10) Cases of Gatorade Recover Whey Protein Bars (120 servings)

* Create Your Own must consist of two different options.

.....*38502 \$155.00 ea.

C. Refuel & Restore High School Performance Package

Includes:

- (1) Case of Gatorade Thirst Quencher Powder (yields 84 gallons total)
- (1) Case of 7 oz. cups (2,000/case) OR (24) Gatorade Contour Bottles

.....*38212 \$75.00 ea.

FUEL YOUR TEAM

For muscle rebuilding after training or competition, athletes can choose from these Gatorade® Protein products: **Whey Protein Powder, Protein Shake, Whey Protein Bar, and Whey Protein with Almond Butter Bar.**

GATORADE, G Design, Gatorade Prime and Gatorade Recover are registered trademarks of S-VC, Inc. ©2019 S-VC, Inc.

*Direct-ship item. Please allow additional time to receive.



2020 GATORADE HIGH SCHOOL PERFORMANCE PACKAGE ORDER FORM

PROGRAM REQUIREMENTS

- Gatorade Performance Package offer valid for High Schools only (Elementary Schools, Middle Schools, Trade Schools, College and Universities not eligible).
- Gatorade Performance Packages are not to be modified and/ or discounted beyond published pricing.
- Gatorade Performance Packages offer is limited to 15 kits per high school
- Gatorade Performance Package offer valid January 1, 2020- December 18, 2020, or while supplies last.
- Select month you wish to receive your Gatorade Performance Package (Package can be shipped anytime during the month selected but no sooner than 10 business days following receipt of order by Gatorade).
- If you would like to receive purchase confirmation and estimated shipment date, please provide e-mail address below.
- Contact your School Health rep to place your order
866.323.5465 or fax this form to 800.235.1305

CONTACT INFORMATION Please print

First Name: _____ Last Name: _____
 Title: Athletic Director Coach Sport: _____
 Athletic Trainer Other Sport: _____
 Email: _____
 Phone: _____

Check the box if you wish to receive more information about other Gatorade® communications.

SHIPPING INFORMATION

High School Name: _____
 High School Address: _____
(PO Box or third-party shipping addresses will not be accepted.)
 City: _____
 State: _____ Zip: _____

Performance Package will ship to the coach listed in the Order Information section below. All package prices include shipping.

ORDER INFORMATION To place your order, please complete the information below:

Sport: _____
 Coach First Name: _____
 Coach Last Name: _____
 Season: Fall Winter Gender: Male Female
 KIT #1: GATORADE PERFORMANCE PACKAGE: #38501 Qty: _____ x \$235 = _____
 (6) Cases of Gatorade Prime® Energy Chews Choose 1 flavor for all, or split between 2 flavors
 All Fruit Punch All Cool Blue 3 of each flavor
 (1) Case of Gatorade® Thirst Quencher Powder (yields 84 gallons total)
 Lemon-Lime Glacier Freeze® Riptide Rush™ Glacier Cherry®
 (8) Cases of Gatorade Recover® Whey Protein Bars (96 servings)
 Choose 1 flavor for all, or split between 2 flavors
 Chocolate Chip Chocolate Caramel Cookies n Crème

Choose up to three of the below options:

- (1) 3 Gallon Cooler (10) Gatorade® Towels
- (1) 7 Gallon Cooler (24) Gatorade® Contour Bottles
- (1) 10 Gallon Cooler (4) Gatorade® Contour Bottle Carriers
- (1) 60 Quart Ice Chest on Wheels (1) Case of 7 oz. Cups (2,000/case)

- KIT #2: CREATE YOUR OWN: #38502** Qty: _____ x \$155 = _____
 - OPTION #1 – (10) Cases of Gatorade Prime® Energy Chews (160 servings)**
 All 10 Fruit Punch All 10 Cool Blue 5 of each flavor
 - OPTION #2 – (1) Case of Gatorade® Thirst Quencher Powder**
AND (1) Case of 7 oz. cups (yields 84 gallons total)
 Lemon-Lime Glacier Freeze® Riptide Rush™ Glacier Cherry®
 - OPTION #3 – (10) Cases of Gatorade Recover® Protein Shakes (120 servings) (pick one)**
OR (10) Cases of Gatorade Recover® Super Shakes (120 servings)
 All 10 Chocolate All 10 Vanilla 5 of each flavor
 (Gatorade Recover® Super Shake available to ship March 2020)
 - OPTION #4 – (10) Cases of Gatorade Recover® Whey Protein Bars (120 servings)**
 Choose 1 flavor for all, or split between 2 flavors
 Chocolate Chip Chocolate Caramel Cookies n Crème
 *Create Your Own must consist of two different options.

- KIT #3: REFUEL & RESTORE : #38212** Qty: _____ x \$75 = _____
 - (1) Case of Gatorade® Thirst Quencher Powder (yields 84 gallons total)
 Lemon-Lime Glacier Freeze® Riptide Rush™ Glacier Cherry®
 - Choice of: (1) Case of 7 oz. Cups (2,000/case) OR (24) Gatorade® Contour Bottles

SELECT A MONTH FOR ARRIVAL† Choose one month for all kits to arrive

JAN '20 FEB '20 MAR '20 APR '20 MAY '20 JUN '20
 JUL '20 AUG '20 SEP '20 OCT '20 NOV '20 DEC '20

† Performance Package will arrive in the month selected on the Gatorade Performance Package Order Form but no sooner than 10 business days following receipt of order form by Gatorade from ATD or G-Force can arrive anytime during the month selected.

CHECK OR PURCHASE ORDER Please attach a copy of the Purchase Order

Check or Purchase Order # _____

AUTHORIZED GATORADE REPRESENTATIVE (SOLD BY)

Athletic Team Dealer Co: _____ ATD/G-Force Rep Name: _____ Date: _____ / _____ / _____
 Customer #: _____ City: _____ State: _____
 Email: _____

ALL PACKAGE PRICES INCLUDE SHIPPING.

Gatorade® Performance Package offer valid January 1, 2020—December 18, 2020, or while supplies last. Requests/orders must be received by December 18, 2020. Product flavors subject to change based on availability. All package prices include shipping. A high school is defined as a secondary school servicing some combination of grades 10 through 12. Flavor substitutions will not be permitted. Offer good only in the 50 United States and D.C. Void in Puerto Rico and where prohibited by law, taxed or otherwise restricted. GATORADE, G DESIGN, G SERIES, GATORADE PRIME, and GATORADE RECOVER are registered trademarks of S-VC, Inc. ©2019 S-VC, Inc.

Gatorade® Prime Fuel Bar

Gatorade Fuel Bars are the new way to fuel up for athletic activity. With carbohydrates and protein, every bar provides convenient on-the-go fuel to help athletes compete.

12/case

Oatmeal Raisin	1006075	\$22.99 cs.
Chocolate Chip	1006076	\$22.99 cs.
Honey Oat	1006078	\$22.99 cs.

Gatorade® Whey Protein Bars with Almond Butter

With a mix of carbs and protein, Recover Whey Protein Bars fuel muscle recovery to help bring muscles back to life.

Gatorade Whey Protein Bars, 12/case

Cookies and Cream	1000024	\$30.99 cs.
Chocolate Caramel.	1000026	\$30.99 cs.
Chocolate Pretzel.	1006073	\$30.99 cs.
Chocolate Chip	1000025	\$30.99 cs.
Mint Chocolate Crunch.	1003328	\$30.99 cs.
Chocolate Peanut Butter	1006074	\$30.99 cs.

Gatorade Whey Protein Bars with Almond Butter, 12/case

Chocolate Chip Cookie	1031313	\$23.99 cs.
Salted Caramel	1031312	\$23.99 cs.
Almond Butter	1031311	\$23.99 cs.



G Series Pro Endurance Formula 02 Perform

Available in ready-to-drink and powder, G Series Endurance Formula delivers almost twice the sodium and more than three times the potassium of Gatorade Thirst Quencher to replace critical electrolytes lost in sweat and help maintain proper fluid balance.

24 oz. Bottle, 24/case

Lemon Lime	38331	\$54.99 cs.
Orange	38332	\$54.99 cs.
32 oz. Canister, Powder		
Orange	38417	\$39.99 ea.
Lemon Lime	38419	\$39.99 ea.

Gatorade® 03 Protein Recovery Shake

20 g of protein, plus electrolytes and carbs. Includes high quality whey (fast acting) and casein (slow acting) protein.

11.6 oz., 12/case

Chocolate	38457	\$28.99 cs.
Vanilla	38459	\$28.99 cs.
Cookies & Cream	38535	\$28.99 cs.



G Series Pro Gatorlytes 02 Perform

Electrolyte mix specially formulated for cramp-prone athletes and designed for use with G Series products.

0.12 oz., 20/box **38334** \$19.99 box



Gatorade® Prime Energy Chews

Pre-game energy chews that deliver a concentrated blend of carbohydrate energy and give athletes the edge to start out strong. Contains same nutritional profile as Prime pouch, delivered in an edible form.

6/pkg., 16/box

Cool Blue	38460	\$27.99 box
Fruit Punch	38461	\$27.99 box
Green Apple	1003326	\$27.99 box
Strawberry.	1006077	\$27.99 box



Gatorade® Recover Whey Protein Powder

Gatorade Recover Whey Protein Powder helps athletes rebuild what they break down after practice or the big game. Gatorade's Sport Formula has a NCAA compliant ratio of protein to carbohydrates.

Per Serving: protein 20 g, carbohydrates 45 g, calories 270.

Bulk, three 20 oz. Canisters

Chocolate	1008100	\$78.49 pkg.
Vanilla	1008101	\$78.49 pkg.
Cookies & Creme	1031945	\$78.49 pkg.
Chocolate Caramel.	1031946	\$78.49 pkg.
Single Serve Pouches, 24/case		
Chocolate	1006071	\$28.95 cs.
Vanilla	1006072	\$28.95 cs.
Chocolate Caramel.	1008111	\$28.95 cs.
Cookies & Creme	1008110	\$28.95 cs.

FREE SHIPPING at SchoolHealth.com/SportsMed

Get FREE SHIPPING on your online order over \$100! Go to the back cover for Free Ship Online code. Can only be used once per customer. Expires 12-31-20.

Nutrition

Gatorade® Instant Powder



Flavor	Item Number	Yield/Package	Case Size	Yield/Case	Price/Case
Fruit Punch	38532	¼ Gallon	144/2.12 oz.	36 Gallons	\$157.99 cs.
Lemon-Lime	38533				
Fruit Punch	38016	1 Gallon	40/8.5 oz.	40 Gallons	\$94.99 cs.
Lemon-Lime	38010				
Orange	38041				
Frost Riptide Rush	38195				
Glacier Freeze	38180	2½ Gallon	32/21 oz.	80 Gallons	\$172.99 cs.
Lemon-Lime	38021				
Orange	38049				
Frost Riptide Rush	38140				
Fruit Punch	38053	6 Gallon	14/51 oz.	84 Gallons	\$154.99 cs.
Glacier Freeze	38179				
Lemon-Lime	38051				
Orange	38052				
Frost Riptide Rush	38141				
Lemon-Lime	38273	20 Ounce	64/packs	10 Gallons	\$48.99 cs.
Orange	38274				
Fruit Punch	38275				
G2, Fruit Punch	38464	20 Ounce	64/packs	10 Gallons	\$49.99 cs.
G2, Grape	38465				
G2, Glacier Freeze	38466				



Gatorade® Liquid Concentrate

Flavor	Item Number	Yield/Package	Case Size	Yield/Case	Price/Case
Fruit Punch	38027	6 Gallon	4/1 Gallon	24 Gallons	\$58.99 cs.
Lemon-Lime	38020				
Orange	38022				
Fierce Grape	1006080				

Gatorade® Bag-N-Box

Flavor	Item Number	Yield/Package	Case Size	Yield/Case	Price/Case
Fierce Grape	38194	½ Gallon	18 Gallons	-	\$79.99 cs.
Fruit Punch	38176				
Lemon-Lime	38119				
Orange	38120				
G2 Fruit Punch	1006079				



Gatorade® Canned

Flavor	Item Number	Yield/Package	Case Size	Yield/Case	Price/Case
Fruit Punch	38078	11.6 oz.	4/6 Packs	2.2 Gallons	\$24.99 cs.
Lemon-Lime	38076				
Orange	38077				



SH School Health Brand Mixing Wand ▶

The Mixing Wand is designed to mix powdered products with water. Its unique mixing valve uses the flow of water to thoroughly mix the water and powdered drink mix. Its 27" length is designed to fill a 10 gallon cooler with ease.

..... 1003618 \$32.99 ea.

▶ Product videos on website



POWERADE® Sports Drink Mix 5 Gallon Pouch (12 Pack)

- Each case includes 12 5-gallon pouches yielding 60 total gallons of Powerade sports drink. Formulated with the ION4® Advanced Electrolyte System, which helps replenish 4 electrolytes lost in sweat
- Powerade also is formulated with B vitamins to help support energy metabolism and a 6% carbohydrate solution to help provide energy to working muscles

5 Gallon Pouch/12 case

Lemon Lime	38496	\$129.99 cs.
Berry Blast	38497	\$129.99 cs.
Tropical Mango	1008207	\$129.99 cs.
White Cherry	1008206	\$129.99 cs.

Gatorade® Propel

Lightly flavored fitness water that is charged with vitamins and other nutrients.

500 mL, 24/case

Berry	38184	\$31.99 cs.
Grape	38477	\$31.99 cs.
Kiwi Strawberry	38478	\$31.99 cs.
Lemon	38183	\$31.99 cs.



V8 Fusion

100% juice gives you the nutrition of vegetables, blended with the just the right amount of fruit juice for a light, sweet taste—plus 1 full serving of fruit and 1 full serving of vegetables.

12 oz. Bottle, 12/case

Pomgranate Blueberry	1007495	\$42.99 cs.
Strawberry Banana	1007496	\$42.99 cs.
8 oz. Can, 6/case		
Grape Raspberry	1007699	\$37.99 cs.



FREE SHIPPING at SchoolHealth.com/SportsMed
 Get FREE SHIPPING on your online order over \$100! Go to the back cover for Free Ship Online code. Can only be used once per customer. Expires 12-31-20.

Nutrition

RXBAR

Take the worry and doubt away when it comes to choosing a healthy, nutritious, and effective energy bar for your athlete. RXBAR only utilizes 5 all-natural ingredients, providing a clean food that you can count on.



FLAVOR	12 BARS	72 BARS	10 PACKETS	60 PACKETS	16 KID BARS	96 KID BARS
Mint Chocolate	1031361	1031399				
Peanut Butter & Berry	1031373	1031395			1031372	1031394
Chocolate Hazelnut	1031371	1031393				
Mango Pineapple	1031370	1031392				
Chocolate Chip	1031365	1031387			1031368	1031390
Peanut Butter Chocolate	1031364	1031386				
Mixed Berry	1031363	1031385			1031366	1031388
Maple Sea Salt	1031362	1031384				
Chocolate Sea Salt	1031360	1031383				
Coffee Chocolate	1031359	1031382				
Coconut Chocolate	1031358	1031381				
Peanut Butter	1031357	1031380	1031374	1031396		
Blueberry	1031356	1031379				
Apple Cinnamon	1031354	1031377			1031367	1031389
Vanilla Almond Butter			1031376	1031398		
Honey Cinnamon Peanut Butter			1031375	1031397		
	\$25.99	\$171.99	\$14.99	\$106.99	\$23.99	\$156.99

**NCAA
Compliant
& NSF
Certified
for Sport**



dotFIT First String Protein Powder

Appropriate for athletes of all ages. The perfect pre- and post-exercise meal. It contains the ideal blend of carbohydrates, protein, and fat needed to maximize workouts, increase strength or size, refuel muscle stores, and enhance performance and competition.

- Contains Aminogen for more complete digestion, absorption, and retention
- Sophisticated ideal blend of the highest quality fast and slow-acting proteins
- Does not contain aspartame and is low sugar
- Ideal carbohydrate mix to help maximize protein synthesis
- Not spiked with unnecessary nutrients

5.3 lbs., 32 servings

Chocolate..... **38507** \$89.55 ea.
Vanilla**38508** \$89.60 ea.

dotFIT ActiveMV Multivitamin

Controlled-release, high antioxidant multivitamin for active teens and adults.

30 Tablets **44561** \$16.75 ea.
60 Tablets **44560** \$24.70 ea.

dotFIT Superior Antioxidant

Trigger your body's natural ability to protect cells against free radicals.

30 Softgels **44557** \$26.20 ea.

dotFIT SuperOmega 3/Fish Oil

Supports cardiovascular health, healthy cholesterol levels, and brain function.

30 Softgels **44558** \$17.25 ea.

dotFIT Joint Flex Plus

For healthy joints & skin! New formula with BioCell Collagen II®, which has been shown to minimize fine lines and wrinkles.

60 Softgels **44559** \$39.55 ea.

dotSTICK Protein Bars

Delicious, nutrient-rich meal substitutes to help manage appetite & provide instant portion control. dotSTICKs provide Omega-3 healthy fats, are a good source of calcium and fiber, and are high in protein.

- This product meets the NCAA guidelines for college athletes
- 12 grams of protein
- 190 calories per bar

1.8 oz. Bar, 12/box

Iced Lemon Vanilla Cream **38505** \$37.20 box

Honey Stingers Organic Cracker Bars

Give yourself a high five for a job well done and indulge with a Honey Stinger Organic Cracker Bar! With organic ingredients, no artificial flavors, colors, or preservatives, and true source honey, there is no reason to feel guilty.

Features:

- True Source honey
- 0% cholesterol
- 0% trans fat
- Perfect for during and after activity
- USDA organic

12/box

Peanut Butter Milk Chocolate.....	1035333	\$26.40 box
Almond Butter Dark Chocolate.....	1035334	\$26.40 box
Cashew Butter Milk Chocolate.....	1035335	\$26.40 box



NEW!



Honey Stingers Organic Stinger Waffles

A great alternative to conventional energy foods, Organic Stinger Waffles provide a tasty boost of sustainable energy on-the-go with two thin waffles infused with True Source honey.

Features:

- A layer of honey sandwiched between two thin waffles
- A healthy snack that tastes great
- USDA certified organic
- 160 calories
- Honey Stinger best seller

16/box

Honey.....	1005317	\$24.99 ea.
Vanilla.....	1005318	\$24.99 ea.
Strawberry.....	1005319	\$24.99 ea.
Chocolate.....	1005320	\$24.99 ea.
Lemon.....	1005321	\$24.99 ea.

Honey Stingers 10 g Protein Bars

Honey Stinger 10 g protein bars are made with 25% organic honey and feature candy bar-like flavor and texture. A fantastic recovery bar or meal replacement with 10 g of whey protein under 200 calories.

Features:

- 25% USDA certified organic honey
- Great recovery snack or meal replacement
- Gluten free ingredients
- Kosher certified
- 190–200 calories
- 10 grams of whey protein

12/box

Peanut Butta.....	1005313	\$39.99 ea.
Dark Chocolate Coconut Almond.....	1005314	\$39.99 ea.
Dark Chocolate Cherry Almond.....	1005315	\$39.99 ea.
Dark Chocolate Mint Almond.....	1005316	\$39.99 ea.



Honey Stingers Organic Energy Chews

USDA certified organic and gluten free, these delicious chews are made with naturally occurring fiber and protein derived from tapioca syrup and honey, providing a multiple carbohydrate punch. Softer than other chews on the market, our Organic Energy Chews won't stick to your teeth and are easy to digest.

Features:

- Certified organic
- Vitamin C
- Potassium
- Gluten free
- Nut free
- Dairy free

Fruit Smoothie.....	1005322	\$30.99 ea.
Cherry Blossom.....	1005323	\$30.99 ea.
Pomegranate Passion Fruit.....	1005324	\$30.99 ea.
Orange.....	1005325	\$30.99 ea.

Honey Stingers Classic Energy Bars

Newly reformulated to create a better texture and taste. Our energy bars are made with over 30% honey, 5 g non-GMO soy protein, 23 vitamins and minerals, whole grains, calcium, antioxidants, natural flavors, and all the benefits of our energy gel.

Features:

- 30% honey
- Whole grains, including rolled oats
- Great before and during exercise
- 180–190 calories
- Made with 5 grams of non-GMO soy protein
- Great taste and texture
- 23 vitamins and minerals

15/box

Berry Banana Buzz.....	1005310	\$36.99 ea.
Rocket Chocolate.....	1005311	\$36.99 ea.
Peanut Butter'n Honey.....	1005312	\$36.99 ea.

GAME CHANGING NUTRITION

CLIF

2020 HIGH SCHOOL EXCLUSIVE

CLIF® PERFORMANCE NUTRITION STARTER PACKAGE

\$190 (UP TO \$650 RETAIL VALUE)

BONUS ITEMS:

- 1 CLIF® Athletic Trainer Sling Bag
- 10 CLIF® Antimicrobial Athletic Towels



CLIF

By purchasing goods under this package offering you hereby confirm that such purchase is compliant with all laws and policies applicable to your Athletic Training Program and facility. Void where prohibited by law, taxed or otherwise restricted. © 2020 Clif Bar & Company. Trademarks and registered trademarks are owned by Clif Bar & Company, or used with permission. CBC19_1930

CLIF High School Performance Nutrition Packages



Clif High School Starter Package

- Eight boxes of CLIF Energy bars (96 bars) Four boxes each of Chocolate Chip and Crunchy Peanut Butter (switch with Chocolate Brownie for peanut-free option)
- Four boxes of CLIF BLOKS Energy Chews (72 sleeves) Two box each of Strawberry and Salted Watermelon
- Eight boxes of CLIF Builder's Protein Bars (96 bars) Four boxes each of Chocolate Mint and Chocolate Peanut Butter (switch with Chocolate for peanut-free option)
- 10 CLIF Antimicrobial Athletic Towels
- One CLIF Athletic Trainer Sling Bag

.....38545 \$199.99 pkg.

Clif High School Refill & Replenish Package

Choose two of the following:

- Six boxes of CLIFBars (72 bars) Three boxes each of Chocolate Chip and Crunchy Peanut Butter (switch with Chocolate Brownie for peanut-free option)
- Six boxes of CLIF Builder's bars (72 bars) Three boxes each of Chocolate Chocolate Mint and Peanut Butter (switch with Chocolate for peanut-free option)
- Three boxes of CLIF BLOKS Energy Chews (54 sleeves) Two boxes of Strawberry and one box of Salted Watermelon

.....38546 \$104.99 pkg.



Clif Nutrition Bars

- Performance nutrition for sustained energy
- Whole, all natural ingredients

- 70% organic ingredients
- Good source of protein and fiber

2.4 oz. Bar, 12/box

Crunchy Peanut Butter	38335	\$22.99 box
Chocolate Chip	38336	\$22.99 box
Cool Mint Chocolate with Caffeine	38337	\$22.99 box
White Chocolate Macadamia	38338	\$22.99 box
Chocolate Chip Peanut Crunch	38339	\$22.99 box
Chocolate Brownie	38340	\$22.99 box
Oatmeal Raisin Walnut	38341	\$22.99 box
Blueberry Crisp	38342	\$22.99 box
Peanut Toffee Buzz with Caffeine	38344	\$22.99 box

Clif Fruit Smoothie Filled Energy Bars

Delivers sustained energy for lower intensity, longer duration activities. Nutrients of an energy bar with the protein and fat found in nut and seed butters, help to reduce glycemic index.

1.76 oz. Bar, 12/box

Tart Cherry Berry	1032085	\$24.99 box
-------------------------	----------------	-------------

Clif Nut Butter Filled Bar

- 20 g of complete protein, with essential amino acids to help repair and build muscle
- Non-GMO ingredient sources
- Carbohydrates to help replenish muscle glycogen stores after a workout
- Vitamins and minerals to support protein metabolism

1.76 oz. Bar, 12/box

Chocolate Hazelnut Butter	54935	\$27.99 box
Chocolate Peanut Butter	54920	\$27.99 box
Coconut Almond Butter	54921	\$27.99 box
Peanut Butter	54922	\$27.99 box
Banana Chocolate Peanut Butter	54923	\$27.99 box
Blueberry Almond Butter	54924	\$27.99 box
Caramel Chocolate Peanut Butter	54925	\$27.99 box

Clif Sweet & Salty Energy Bars

Nutrition for sustained energy: Our bars are purposefully crafted to deliver the protein, fiber, and carbs to sustain active bodies. A perfect energy snack to fuel up with, before activity.

1.76 oz. bar, 12/box

Chocolate Chunk with Sea Salt	1032080	\$20.99 box
Peanut Butter & Honey with Sea Salt	1032081	\$20.99 box
Caramel Toffee with Sea Salt	1032082	\$20.99 box

Nutrition



A



B



C



D



E



F



G

A. Clif Shot Bloks Electrolyte Chews

- 33 calories per chew for easy tracking of caloric and electrolyte intake
- Energizes during activity with carbs and electrolytes
- Black Cherry contains 50 mg of caffeine; Orange and Tropical Punch contain 25 mg of caffeine
- Margarita contains 3x sodium to ward off muscle cramps

6 Bloks/Pkg., 18/box		
Cran-Razz.	38345	\$44.99 box
Strawberry.	38346	\$44.99 box
Black Cherry with Caffeine.	38347	\$44.99 box
Mountain Berry.	38348	\$44.99 box
Tropical Punch with Caffeine.	38350	\$44.99 box
Orange with Caffeine.	38351	\$44.99 box
Margarita with 3x Sodium.	38353	\$44.99 box
Citrus.	38471	\$44.99 box

B. Clif Builder's Bar

- 20 g of complete protein, with essential amino acids to help repair and build muscle
- Carbohydrates to help replenish muscle glycogen stores after a workout
- Vitamins and minerals to support protein metabolism
- Non-gmo ingredient sources

12/box		
Chocolate Peanut Butter.	38354	\$27.99 box
Lemon.	38359	\$22.99 box
Cookies 'N Cream.	38358	\$27.99 box
Mint Chocolate.	38355	\$27.99 box
Crunchy Peanut Butter.	38473	\$27.99 box
Vanilla Almond.	38357	\$27.99 box
Chocolate.	38356	\$27.99 box

C. Clif Hydration Electrolyte Drink Mix

Crafted to hydrate during activity. 4% carbohydrates and all five electrolytes to help your body absorb and retain fluid for effective hydration.

15.5 oz. Pouch, 6/pkg.		
Lemon Limeade.	1032077	\$99.99 pkg.
Cranberry Razz.	1032078	\$99.99 pkg.

D. Clif Energy Granola

Made with hearty clusters of organic oats, almonds, cashews, seeds, and dried fruit. 8 grams of plant-based protein. 25–27 grams of whole grains. Good source of fiber, certified organic, and gluten free.

6 oz. Pouch, 10/case		
White Chocolate Macadamia Nut.	1032087	\$31.99 cs.
Cocoa Almond.	1032088	\$31.99 cs.
Cinnamon Almond.	1032089	\$31.99 cs.
Blueberry Crisp.	1032090	\$31.99 cs.

E. Clif Shot Energy Gel

- Use during activity to replace carbohydrates and electrolytes
- Fast-acting, easy-to-digest source of carbohydrates
- 90% organic ingredients
- Mocha contains 50 mg of caffeine, Strawberry contains 25 mg, and Double Espresso contains 100 mg

1.2 oz., 24/box		
Raspberry.	38360	\$31.99 box
Mocha with Caffeine.	38361	\$31.99 box
Strawberry with Caffeine.	38362	\$31.99 box
Vanilla.	38363	\$31.99 box
Double Espresso with Caffeine.	38364	\$31.99 box
Chocolate.	38365	\$31.99 box

Clif Recovery Protein Drink Mix

10 grams of high quality whey and casein to help rebuild muscle, organic glucose to help restore muscle glycogen and sodium to help replenish what is lost during activity.

16.6 oz. Pouch, 6/case		
Chocolate.	1032079	\$114.99 cs.

F. Clif Whey Protein Bar

- Delivers on the demand for high protein & 5 grams or less of sugar
- 14g of complete protein from whey, rice, and pea
- Low glycemic index
- 5g sugar with no sugar alcohols (Maltitol, Erythritol) or non-nutritive sweeteners (Sucralose)
- Non-GMO ingredient sources, whey protein from cows not treated with rbST

1.98 oz. Bar, 8/box		
Coconut Almond Chocolate.	54932	\$27.99 box
Peanut Butter Chocolate.	54933	\$27.99 box
Salted Caramel Cashew.	54934	\$27.99 box

G. Luna Nutrition Bar

- Created by and for women and their specific nutritional needs
- Whole, all natural ingredients
- 70% organic ingredients
- High in calcium, folic acid, and iron
- Rich in antioxidants
- Good source of vitamin D
- 24 vitamins and minerals
- 8–10 g of protein
- 3–5 g of fiber

1.69 oz. Bar, 15/box		
Nutz Over Chocolate.	38371	\$24.99 box
Lemon Zest.	38372	\$24.99 box
White Chocolate Macadamia.	38374	\$24.99 box
Chocolate Peppermint Stick.	38375	\$24.99 box
S'mores.	38376	\$24.99 box
Caramel Nut Brownie.	38377	\$24.99 box
Chocolate Dipped Coconut.	38380	\$24.99 box



Pedialyte® Oral Electrolyte Maintenance Solution

Prevents dehydration due to diarrhea or vomiting. Specially formulated to promote quick absorption and contains an appropriate, clinically proven balance of fluid and electrolytes. Comes in ready-to-drink, 1-Liter bottles.

Unflavored	34869	\$10.95 ea.
Fruit Flavor	34870	\$11.20 ea.
Grape Flavor	34868	\$10.95 ea.

Quench Gum®

Contains citric acid, salivary stimulants, dextrose and fast-acting potassium salts to quench thirst faster. Tub contains four delicious flavors: lemon, fruit punch, orange, and grape.

Approx. 300/tub	38019	\$44.99 ea.
Variety Pack, 25/pkg.	38215	\$4.49 pkg.



Heat Relief Products

A. Medi-Lyte Heat-Relief Tablets

Helps provide temporary relief from heat stress, fatigue and muscle cramping by replenishing minerals lost to heat and perspiration. Sodium-free, sugar-free and lactose-free. Active ingredients: potassium chloride (40 mg.), calcium phosphate (18 mg.) and magnesium carbonate (9 mg.).

UNIT DOSE

50 /2's	44218	\$7.55 ea.
250 /2's	44219	\$25.85 ea.

B. Fosfree Soluble Calcium with Vitamins

Stops troublesome muscle cramping.

120's	44080	\$17.40 ea.
500's	44004	\$75.10 ea.

C. Heat Guard Slow Release Electrolyte Replenisher

Designed to provide the slow release of the tablet's salt content over a period of four hours.

1000's	44223	\$87.85 ea.
------------------	--------------	-------------

GO-TO GO TO PAGE 246 FOR HEAT STRESS MONITORING PRODUCTS



A



B



C



D

A. Polar Life Pod

An on-demand water immersion device that can quickly be set up to use wherever and whenever needed. It is made out of a heavy duty PVC and is capable of fitting athletes up to 7' Tall and weighing up to 400 lbs. One size fits all.

.	1003503	\$468.99 ea.
-----------	----------------	--------------

B. Rubbermaid® Cool Down Tubs

The Cooling Tub allows athletes to get in and relax while cooling their core temperature. Perfect for athletes who need to cool down after practice prior to entering the field house or great to use when athletes have been over-exposed to heat. Fill it with water and it is ready to use.

300 Gallon Tub (Shown)

63¼"L x 69"W x 25"H	*61664	\$509.99 ea.
150 Gallon Tub		
58"L x 39"W x 25"H	*38284	\$337.99 ea.

C. Cramer® Stay Cool Sports Team Bucket & Towels

Includes one 3.5-gallon bucket with lid and 12 Stay Cool Towels.

17" x 13".	37192	\$174.99 ea.
--------------------	--------------	--------------

D. Cramer® Stay Cool Sports Towels

Absorbs sweat and water five times faster than a cotton towel. Rinse with cool water to refresh. Machine washable. Used properly, it will not support the growth of bacteria or mold. Two sizes to accommodate all sports.

17" x 13".	37159	\$16.99 ea.
27" x 17".	37161	\$22.99 ea.

*Direct-ship item. Please allow additional time to receive.

Hydration Testing



A

B

A. HydraTrend™

Easy-to-use HydraTrend™ urine test strips provide feedback about an individual's hydration status. Gives results in 30 to 60 seconds. Includes 50 test strips, a sample collection cup, complete instructions, a color chart for reading results, quality controls, and a card for recording test results over time.

50/kit44320 \$37.05 kit

Urinary Test Strips

B. Multistix 10SG

Tests for urinary blood, bilirubin, urobilinogen, ketones, protein, nitrite, glucose, pH, specific gravity, and leukocytes.

Test Strips, 100/box44193 \$93.90 box

GEN-10SGL

(Comparable to Multistix)

Test Strips, 100/box44194 \$64.25 box



C



D



E

C. Refractometer

Measures the concentration of an aqueous solution by measuring its refractive index. Metal body, rubber hand grip blocks hand heat, calibration screen, cushioned rubber eyepiece, non-roll stand, prism mounted in high impact plastic. Includes case, calibration screwdriver, and plastic pipette.

Specifications:

Range: 0-12g/dl protein in serum

Resolution: 0.2g/dl, 0.005sg, 0.0005 RI

Applications: protein/urine, ATC

.....90700 \$175.00 ea.

D. ATAGO® Digital PEN Refractometer

– Urine SG: 1.0000-1.0300

– Minimum Scale: 0.0001

– Accuracy: ±0.0010

– Automatic temperature compensation: 10–40°C

• Digital display: easy and accurate readings, without user interpretation

• Fast & easy: measures in 2 seconds

• Full-body water resistant: run it under the faucet for fast and easy cleanup

• Zero-set with water: no standard liquids required

• 8000 measurements: from a single alkaline “AAA” battery

16 cm x 3.8 cm x 1.8 cm, 70 g61716 \$787.00 ea.

E. ATAGO® Pocket PAL-10S Refractometer

The PAL-10S is a digital hand-held compact refractometer to measure urine S.G. To operate it, simply place a drop of urine on the prism top and press the “Start” key. Then, the urine S.G. value will be displayed on the LCD instantly.

Specifications:

Measurement range: Urine S. G. 1.000 to 1.060

Measurement accuracy: Urine S.G. scale ±0.001

Ambient Temperature: 10 to 35°C

Measurement time: 3 seconds

Resolution: Urine S. G. 0.001

Measurement Temperature: 10 to 35°C

Sample volume: 0.3 ml

Power Supply: Two “AAA” Batteries

55 x 31 x 109 mm, 100 g61576 \$623.50 ea.

FREE SHIPPING at SchoolHealth.com/SportsMed

Get FREE SHIPPING on your online order over \$100! Go to the back cover for Free Ship Online code. Can only be used once per customer. Expires 12-31-20.



Emergency Response & Safety



- SCHOOL HEALTH IS THE #1 SUPPLIER OF AEDS TO SCHOOLS. ASK US ABOUT OUR PRICE MATCH GUARANTEE!



- SCHOOL HEALTH IS AUTHORIZED TO HONOR STATE PRICING CONTRACTS WHERE AVAILABLE. WE ALSO GIVE VOLUME DISCOUNTS! CALL FOR SPECIAL PRICING.
- CALL SCHOOL HEALTH TO SEE HOW YOU CAN GET MONEY FOR YOUR OLD AED DEVICES.
- SCHOOL HEALTH OFFERS AED LEASING TO HELP YOU PURCHASE LIFESAVING DEVICES AT A LOW MONTHLY OR ANNUAL COST.

AEDs and Trainers	221-224
AED Program Management	225
AED Cabinets & Accessories	226
Bag Valve Mask & Oxygen	227
Suction Devices	228
CPR Protective Barriers	229
Bleeding Control Products	230-233
Emergency Kits	234-236
Evacuation Chairs & Sleds	237

Stretchers & Immobilizer	238
Backboards & Collars	239
Wheelchairs & Transport Chairs	240
Crutches	241
Splints & Slings	242-244
Weather Monitoring	245-246
2-Way Radios	247
Emergency Blankets & Tools	248



Cardiac Science

365
DAYS

vs

other devices

52
DAYS

Powerheart® AEDs fully self-test every day of the year. Most competitors only self-test once a week!

At Cardiac Science, we won't compromise on our belief that the most important thing an AED can do is be ready and able to rescue every day. That's why Powerheart AEDs conduct extensive self-tests every single day of the year on their electrodes, batteries and circuitry, to ensure these critical components are present and fully functional.

Studies have shown that over 20% of AEDs deployed in the U.S. are not ready to rescue.¹ Further, almost half of the readiness failures are due to electrodes or battery issues²—the very problems Powerheart self-tests are specifically designed to detect. So we'll continue to self-test 365 days a year, and you can continue to be assured that Cardiac Science AEDs are...

TESTED EVERY DAY. **RESCUE READY EVERY DAY.**

1. Sutton et al. American Heart Association 2018 abstract. University of Louisville online article: "Before you need that AED, make sure it's functional."
University of Louisville School of Medicine website. <https://louisville.edu/medicine/news/before-you-need-that-aed-make-sure-it2019s-functional>

2. Annals Emergency Medicine; Analysis of Automated External Defibrillator Device Failures Reported to the Food and Drug Administration, Volume 59, no. 2, February 2012.



Cardiac Science Powerheart G5 AED

The Powerheart G5 is the first FDA-cleared AED to combine fully automatic shock delivery, dual-language functionality, variable escalating energy, and fast shock times.

The G5 is the only AED that notifies you 30 days prior to electrode and battery expiration!

ADVANCED TECHNOLOGY—Delivers patient customized post-CPR shock in as few as 10 seconds for effective therapy and enables quick transfer and review of data via USB.

INTERCHANGEABLE PADS—Nonpolarized pads can be placed in either position on the chest (upper right or lower left) to reduce confusion.

RESCUE READY TECHNOLOGY—Device self-checks all main AED components (battery, hardware, software, and pads) daily. Highly visible Rescue Ready indicator assures rescuers that they are retrieving a working AED.

SELF CHECKS—Daily, weekly, and monthly self-tests ensure that pads, battery, and internal circuitry are always working.

INTELLISENSE TECHNOLOGY—Enables the Powerheart G5 to be the only AED to test for presence and function, and have the intelligence to notify you 30 days prior to electrode and battery expiration.

DUAL LANGUAGE—Switch to an alternate language during a rescue with the push of a button (available in English/Spanish).

RESCUECOACH—User-paced prompts guide users through each critical step of a rescue.

DURABILITY—With an IP 55 rating, the Powerheart G5 features a rugged, durable design for transport, storage, and use in challenging settings. 8-year warranty and 4-year full replacement guarantee on Powerheart G5 AED Intellisense battery.

Cardiac Science G5 AED S Packages & Accessories

All packages include:

- (1) G5 Intellisense battery
- (1) Set of G5 adult defibrillation pads
- (1) Powerheart G5 carry sleeve
- (1) AED manager
- (1) USB cable
- (1) Printed G5 user guide, steps to rescue, getting started, and multi-lingual electrode instructions for use

Weight: 5.7 lbs.

Fully Automatic, Spanish/English	*53443	\$1,695.00 ea.
Fully Automatic, with CPR Feedback, Spanish/English	*53447	\$1,820.00 ea.
Fully Automatic, English Only	*53441	\$1,695.00 ea.
Fully Automatic, with CPR Feedback, English Only	*53445	\$1,820.00 ea.
Semi Automatic, Spanish/English	*53444	\$1,695.00 ea.

Semi Automatic, with CPR Feedback, Spanish/English	*53448	\$1,820.00 ea.
Semi Automatic, English Only	*53442	\$1,695.00 ea.
Semi Automatic, with CPR Feedback, English Only	*53446	\$1,820.00 ea.

Cardiac Science G5 Accessories

G5 Intellisense Battery55858	\$409.00 ea.
G5 Intellisense Pediatric Pads55951	\$104.50 pkg.
G5 Intellisense Adult Pads55950	\$70.95 pkg.
G5 Rescue Ready Kit55900	\$64.99 kit
Cardiac Science iCPR Adult Electrode55915	\$218.00 ea.
G5 AED Fabric Carry Sleeve	1033914	\$69.00 ea.
G5 AED Hard-Sided Case	1033915	\$112.00 ea.
G5 AED Rescue Backpack55954	\$159.00 ea.
G5 AED Heavy Duty Case55952	\$399.00 ea.



Powerheart G3 Plus

- Easy-to-follow audible voice prompts are displayed on a backlit text screen
- Interchangeable defibrillation pads which can be placed in either position on the chest to reduce confusion
- STAR biphasic technology calculates electrical impedance
- Self-checks all main AED components (battery, hardware, software, and pads) daily
- Rescue Ready status indicator lets you know that all AED components are working
- 7-year warranty

G3 packages include:

- (1) Powerheart AED RescueCoach voice/text prompts
- (1) Battery with 5 year shelf life and 4 year performance guarantee
- (1) User manuals, getting started guides, and steps to rescue AED manager reporting software
- (1) 1 set of adult pads
- (1) Rugged carrying case
- (1) Ready Kit (nitrile gloves, razor, scissors, towel, 4" gauze, antiseptic wipes, one-way mask, and d-ring attachment)

Powerheart AEDs are compliant with the current 2015 guidelines.

Cardiac Science G3 Plus AED & Accessories

Weight: 6.6 lbs.

Fully Automatic	*55772	\$1,445.00 ea.	Battery for Powerheart G3, Yellow Lithium	
Semi-Automatic	*54197	\$1,445.00 ea.	G3 Plus Yellow Lithium Battery54235 \$399.00 ea.
G3 Plus AED Trainer54195	\$437.50 ea.	G3 Plus Pediatric Pads54120 \$101.50 pkg.
			G3 Plus Adult Pads54119 \$51.00 pkg.
			Battery for Powerheart® G3 Pro54331 \$399.00 ea.

*Requires Rx authorization. See page 301.

AEDs

NEW!



LIFEPAK® CR2 Defibrillator with LIFELINKcentral™ AED Program Manager

While other AEDs may be difficult to use or require users to stop CPR during analysis, the LIFEPAK CR2 defibrillator uses simple graphics, audible instructions, and automated features to help users remain focused. We've removed all the guesswork with proven better results. The CR2 was rated easiest to use, easiest to hear, and highest in overall user confidence by AED users.

- Self-monitoring
- Wireless connectivity
- Fastest time to first shock
- cprINSIGHT™ analysis technology
- Layered, easy-to-follow design

Semi-Automatic, WiFi-Enabled

English with Bag	1034023	\$1,995.00 ea.
English with Handle	1034024	\$1,895.00 ea.
English/Spanish with Bag	1034027	\$2,095.00 ea.
English/Spanish with Handle	1034028	\$1,995.00 ea.

Fully-Automatic, WiFi-Enabled

English with Bag	1034025	\$2,095.00 ea.
English with Handle	1034026	\$1,995.00 ea.
English/Spanish with Bag	1034029	\$2,195.00 ea.
English/Spanish with Handle	1034030	\$2,095.00 ea.

Accessories

CR2 Replacement Electrode Kit	1033999	\$147.50 kit
CR2 Replacement Battery Kit	1034000	\$250.00 kit
CR2 Trainer Kit	1034012	\$649.00 kit



LIFEPAK® AEDs

Every LIFEPAK AED is capable of delivering up to 360 joules of energy for difficult-to-defibrillate patients.

Trusted technology. More emergency medical professionals use biphasic high-energy waveform technology found in LIFEPAK devices.

LIFEPAK CR® Plus AED

Combines easy, two-step operation with just the right level of guidance. The ClearVoicetm audio prompt technology enhances sound quality for better clarity in loud and chaotic environments.

Fully Automatic	*54142	\$1,775.00 ea.
Semi Automatic	*54146	\$1,699.00 ea.
LIFEPAK CR Plus CHARGE-PAK with 1 set electrodes54047	\$104.50 ea.

LIFEPAK® 1000 AED

An easy-to-use AED designed for responders with more advanced training. A large, intuitive screen displays graphics and ECG readings that are clear and easy to read. The LIFEPAK 1000 also features cprMAXtm technology which minimizes interruptions by allowing compressions to continue during AED charging.

With Graphical Display	*54179	\$2,419.00 ea.
With ECG Display	*55582	\$3,090.00 ea.
Adult Electrodes54022	\$42.15 ea.

Pediatric Electrodes for All LIFEPAK® AEDs

Infant/Child Electrodes with Pouch54058	\$153.50 ea.
Infant/Child Electrodes without Pouch54059	\$113.00 ea.

HeartSine® AEDs

Designed specifically for the lay responder, HeartSine samaritan AEDs offer industry-leading value and environmental protection, all in an easy-to-operate system in the smallest and lightest package available.

Features:

- Integrated electrode and battery options: Pad-Pak™, Pediatric-Pak™, and TSO-certified Pad-Pak
- Warranty: 8 years on device, 4 years on Pad-Pak
- Biphasic waveform with impedance compensating escalating energy 150/150/200J
- Highest level of protection from dust and water
- Weighs only 2.4 lbs. and up to 56% smaller than other AEDs

HeartSine samaritan® PAD 360P AED and PAD 350P AED

The HeartSine samaritan PAD 360P is a simple-to-own, fully automatic defibrillator, designed to be durable, affordable, and highly user-friendly.

• CPR coaching with metronome		
samaritan PAD 360P AED Automatic	*55424	\$1,335.00 ea.
samaritan PAD 350P AED Semi-Automatic w/1 Adult Pad-Pak	*54340	\$1,205.00 ea.
samaritan Adult Pad-Pak54164	\$185.00 ea.
samaritan Pediatric Pad-Pak54186	\$219.00 ea.
samaritan PAD 350PAED Trainer55567	\$399.00 ea.

HeartSine samaritan® PAD 450P AED

A semi-automatic defibrillator, adds integrated CPR Rate Advisor™ that uses only the defibrillator electrodes to monitor and uniquely provide visual and verbal feedback on the rate of applied CPR. This exclusive technology effectively assists the rescuer to perform CPR.

samaritan PAD 450P AED w/1 Adult Pad-Pak	*55907	\$1,670.00 ea.
samaritan PAD 450P AED Trainer55908	\$392.50 ea.

*Requires Rx authorization. See Index section for form.



ZOLL AED Plus®

The ZOLL® AED Plus® provides the best support for resuscitating a victim of sudden cardiac arrest. The AED Plus is the first and only automated external defibrillator (AED) with Real CPR Help® technology for monitoring depth and rate of chest compressions during CPR.

The ZOLL AED Plus

Approximately 50% of sudden cardiac arrest (SCA) cases initially require a shock. All rescues require high-quality CPR.

ZOLL's patented Real CPR Help® provides rescuers with integrated, real-time CPR feedback on depth and rate of compressions for high-quality CPR. In addition to Real CPR Help, the AED Plus offers:

- Low cost of ownership, including more efficient lifetime maintenance from longer lasting batteries and longer lasting pads. (Pads last five years.)
- Voice and text prompts to guide rescuers
- 7-year device warranty option
- Weekly and monthly self-tests by default—or customize as often as daily

A. ZOLL AED Plus

Includes AED Plus Device, one-piece electrode (CRP-D-padz), one sleeve of batteries, medical prescription, and soft carry case.

Fully Automatic	*54411	\$1,699.00 ea.
Semi-Automatic	*54412	\$1,699.00 ea.
AED Plus Trainer 2	54359	\$419.00 ea.

B. ZOLL Pedi-Padz II

The ZOLL AED Plus Intelligent Pediatric Capability includes voice and text prompts that tell rescuers that Pedi-Padz II are connected, ensuring that the proper defibrillator electrodes are being used.

Pedi-Padz II	54156	\$99.99 pkg.
------------------------	--------------	--------------

C. ZOLL CPR-D-Padz

ZOLL's Full-Rescue AEDs feature CPR-D-padz, a one-piece, pre-connected electrode with Real CPR Help feedback. Ordinary AEDs require that the rescuer use two separate electrodes. By using CPR hand placement as the landmark, it is easy to place the CPR-D-padz on the victim quickly. The CPR-D-padz also lasts five years—the longest shelf life of any defibrillator electrode sold today.

Replacement CPR-D-padz	54154	\$179.50 ea.
----------------------------------	--------------	--------------

ZOLL AED Plus Accessories

D. Replacement Lithium Battery	54153	\$45.50 ea.
Stat Padz II without CPR Feedback	54155	\$51.99 ea.
CPR Stat Padz, HVP Multi-Function	55505	\$84.99 ea.
E. AED Plus Soft Carrying Case	54301	\$119.00 ea.
F. AED Wall Cabinet with Alarm	54363	\$229.00 ea.

*Requires Rx authorization. See Index section for form.



A

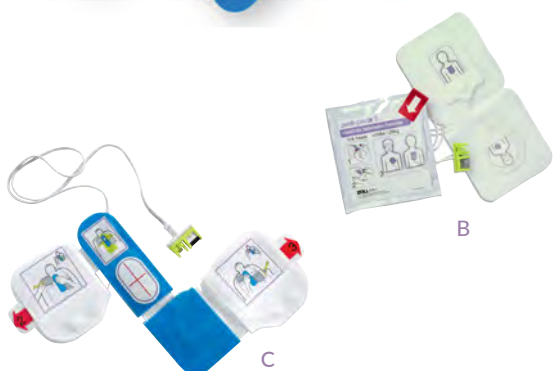

B



C



E



D



F

AEDs and Trainers



A. Philips® HeartStart OnSite AED

- Easy to use—simply pull up the handle on the front of the AED to activate
- Quick shock feature—reduces the time between hands-off and shock delivery
- Visual cues—visual instructions designed to communicate instantly

With Standard Carrying Case	*5519	\$1,399.00 ea.
With Slim Carrying Case.	*5520	\$1,359.00 ea.
Replacement Battery Pack.54109	\$178.50 ea.
Adult Electrode Pad Cartridge54110	\$70.10 ea.
Infant/Child Electrode Pad Cartridge54111	\$113.50 ea.
AED Trainer.54219	\$427.50 ea.

B. Defibtech Lifeline® AED

- Voice prompts—guides the user through the rescue and the progress lights provide visual text guidance to reinforce voice instructions
- Active status indicator—indicates unit readiness
- IP 54 rating
- Ergonomic design—compact, portable and lightweight

Lifeline Auto AED with 7 Year Battery	*55931	\$1,559.00 ea.
Lifeline Semi-Auto AED with 7 Year Battery	*54217	\$1,529.00 ea.
Lifeline AED Trainer.54218	\$482.00 ea.
Lifeline Adult Electrode Pads		
1 Pair/pkg.54190	\$60.00 pkg.
Lifeline Pediatric Electrode Pads		
1 Pair/pkg.54191	\$117.00 pkg.
Lifeline Battery Pack, 7 Years54189	\$237.50 ea.

C. Defibtech Lifeline View

- The Lifeline View full-color interactive display gives step-by-step instructions for performing CPR, rescue breathing, and external defibrillation
- Text prompts are clear and easy-to-read
- Built-in metronome that counts out the beat so you know what to do and when to do it
- Runs extensive self-tests daily to be sure that it's working properly
- Compact, portable, and lightweight—under 3 lbs.
- IP55 rating

Lifeline View AED	*54349	\$1,749.00 ea.
Lifeline View Battery Pack w/4 Year Battery54350	\$202.50 ea.
Lifeline View Pediatric Electrode Pads54352	\$119.99 ea.
Lifeline View Adult Electrode Pads54351	\$71.45 ea.

*Requires Rx authorization. See Index section for form.



D. Prestan Professional AED Trainer Plus

Leading-edge AED Trainer that most closely resembles brand AED Trainers in size and weight for a realistic training experience. Features customizable options to match training environments and has a child button. Unit includes one set of Adult/Child training pads with pad sensing system, a pads storage case, a carry bag with instructions and batteries for the unit.

- Pads can be used at least 25-30 times during CPR/AED classes
- Pads sense when they are attached to the manikin torso
- Module contains up-to-date guidelines and language capability
- Compatible with any CPR manikins
- Can be used with both semi and fully-automatic versions
- Metronome counts to help the student with chest compressions

AED Trainer PLUS with English/Spanish Module	1033927	\$177.50 ea.
AED Trainer PLUS with English/Spanish Module 4/pkg.	1033928	\$661.00 pkg.
E. Optional Remote.54387	\$30.55 ea.

F. Prestan UltraTrainer AED Trainer

This compact and lightweight unit provides a realistic training experience with training pads that sense when they are placed on a manikin.

Features:

- Dual graphic (adult/child) training pads
- Pad sensing system
- Preconnected pads
- Child training button
- Child AED-specific voice prompts
- Automatic or semi-automatic shock simulation
- CPR coaching, turn on or off "give breaths" voice prompt
- Turn on or off compression metronome
- Low battery warning
- 3-Year warranty
- Two languages
- 2015 Guidelines compliant and upgradable
- Play/pause button
- 5 training scenarios

Prestan UltraTrainer AED Trainer, English/Spanish59900	\$107.50 ea.
4/pkg.59901	\$412.00 pkg.
Prestan UltraTrainer Adult/Pediatric Training Electrodes59904	\$17.99 ea.
4/pkg.59905	\$65.65 pkg.

G. AED Practi-TRAINER Essentials

The AED Practi-Trainer Essential AED trainer offers a universal training experience to prepare students to use a variety of different AEDs. It features two preprogrammed scenarios, clear voice prompts, built-in English and Spanish options, and a metronome. Compatible with any type of CPR manikin that is intended for AED training.

.55509	\$99.35 kit
4/pkg.55030	\$349.00 pkg.

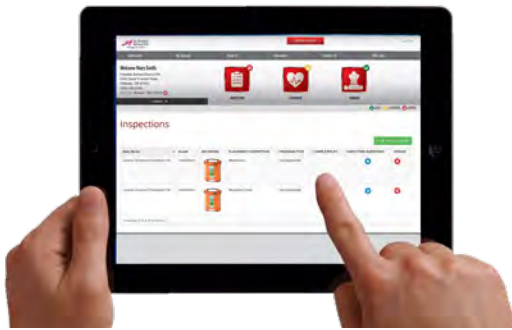

School Health Brand AED Program Management is Simple, Effective, and Affordable

Access your AED program anytime, anywhere and ensure your AED is ready when you need it! When choosing how to manage your AED program—keeping your school compliant, your staff trained, your AEDs serviced, and your data tracked—trust School Health to be your one-stop solution.

Key Benefits



Automated Tracking & Reminder

- Monthly email notifications to perform AED maintenance checks
- A series of email alerts at 60/30/15 day intervals to inform you AED components are expiring
- Program director receives escalation alerts if a deadline is missed
- Responder training, certification, and other device tracking



Improved Workflow

- Intuitive software makes your job easier
- Easy-to-navigate customized dashboard offers visibility to all your devices
- Manage all maintenance activities in one system and create a consistent operations standard
- Check expiration dates, inspection logs, and more from your computer or mobile device



Maintenance & Compliance Assistance

- Assist with registering your device with local emergency medical services
- Physician oversight of your AED program
- Notify you of changes to Federal and State AED laws
- We can manage any AED device in your inventory

School Health Brand AED Program Management

Includes:

- Automated tracking and reminders
- Training and support
- Maintenance and compliance assistance
- Free loaners after SCA events

1 Year Per AED.....	59702	\$79.95 ea.
2 Years Per AED.....	59462	\$149.95 ea.
4 Years Per AED.....	59463	\$229.95 ea.
8 Years Per AED.....	56890	\$449.00 ea.

AED Cabinets & Accessories



A



B



C



D

**UNIVERSAL
CABINET
FITS ANY AED!**

School Health Brand AED Wall Cabinets

These surface mount wall cabinets accommodate every major AED brand. Keyless alarm can be controlled from outside or inside the cabinet. Alarm produces 90 decibels. Magnetic door latch provides solid closure and trouble-free opening. 1-year limited warranty.

Dimensions: 14"W x 15"H x 6¼"D, 10 lbs.

- A. With Sound Alarm*54241 \$209.00 ea.
- B. Sound and Strobe Alarm*55920 \$279.00 ea.

* Wall-mounting hardware not included with AED cabinet. Please refer to installation manual for hardware guidelines.

C. School Health Brand Outdoor AED Cabinet with Strobe Alarm and Temperature Control

This wall-mounted AED cabinet's unique design and red color clearly identifies that an AED is stored in the cabinet. A light inside the AED cabinet is triggered when the surrounding light is dim, so the AED is visible at all times. The cabinet features a climate control heating and cooling system, a survival sequence instruction label, an audible alarm, a strobe-light alarm, and wall-mounting hardware. The 90dB audible alarm uses a 24 Volt DC included with the cabinet.

- 15¼"L x 8"W x 16½"H, 7 lbs.59843 \$629.00 ea.

D. Universal AED Cabinet

This 9" deep, surface-mount AED cabinet is designed to accommodate all AED's on the market today. Alarm produces 85 decibels.

15"W x 15"H x 9"D

- Without Strobe Alarm..... 1002078 \$209.00 ea.
- With Strobe Alarm55693 \$229.00 ea.



E



F



G



H



I



J

- A. School Health Brand AED Inspection Tag
3" x 6"55926 \$1.67 ea.
- B. School Health Brand 3-D Projecting AED Sign
8" x 8"54097 \$23.99 ea.
- C. School Health Brand AED Facility Window Sticker
5" x 5"58990 \$2.28 ea.
- D. School Health Brand Directional AED Sign
10" x 10"54098 \$18.99 ea.
- E. School Health Brand AED Projection Wall Sign
8" x 14.5"55923 \$28.95 ea.
- F. School Health Brand Plastic Perpendicular Flange Mount AED Sign
10" x 8"55925 \$15.05 ea.



K



L

- K. School Health Brand AED/CPR First Responder Kit
Contains:
 (1) CPR mask
 (1) Eye shield
 (2) Pair nitrile gloves
 (2) Antimicrobial wipes
 (1) Absorbent towel (13" x 18")
 (1) Medical prep razor
 (1) Heavy-duty clothing shears
 (1) Bio-hazard bag
 (1) Nylon carry pouch with belt loop
55380 \$22.70 ea.
- L. School Health Brand AED Prep Kit
Contains:
 (2) BZK antiseptic wipes
 (2) Sterile pads, 4" x 4", 12-ply
 (4) Nitrile glove, large
 (1) Pocket mask in bag
 (2) Sani-hands® ALC
 (1) Biohazard bag 24" x 23" (1.5 ml)
 (2) Wiping cloth 12" x 12
 (1) Shears, para-med 5.5" black
 (1) Clear plastic bag
54592 \$17.75 ea.

Bag Valve Mask & Oxygen

A. Allied L770 Disposable Bag Valve Mask

A single patient use system for manual ventilation. The L770 BVM offers accurate, dependable operation coupled with the ability to manually feel a patient's respiratory response, all in a tamper-proof package for single patient use.

Infant	55632	\$17.80 ea.
Child	55631	\$17.80 ea.
Adult	55630	\$17.80 ea.

B. Laerdal® The BAG II Disposable Bag Valve Mask with Handle

The Laerdal The BAG II Disposable Bag Valve Mask with Handle features transparent PVC construction, an ergonomic design to help reduce hand fatigue, reinforced non-kink O₂ tubing that prevents flow obstruction, a closed system oxygen reservoir that allows 99–100% O₂ administration, and universal tubing that fits directly on the flowmeter without an adapter.

Large Adult	57933	\$17.30 ea.
Child	57935	\$17.30 ea.
Infant	57937	\$17.30 ea.



C. Pocket BVM with Black Case

It is ideal in either emergency or clinical settings and replaces any standard BVM, combining all components and operational capabilities into one compact unit.

.....	57706	\$53.20 ea.
-------	--------------	-------------

NEW!



A



B



C



D

A. Rapid Oxygen R15

Rapid Oxygen R15 is a lifesaving, safe, and reliable emergency oxygen that goes anywhere dangerous compressed O₂ cylinders are not permitted. Over the counter. No prescription or special training needed. The R15 meets or exceeds FDA guidelines for portable chemical oxygen generators. The R15 produces 100% humidified oxygen at flows greater than 6 liters/minute for more than 15 minutes with acceptable safe temperatures on all its surfaces. Since the R15 doesn't require a power source and can be safely stored for an extended period, it can be now be used in schools where oxygen cylinders are prohibited.

.....	1033951	\$395.00 ea.
-------	----------------	--------------

B. Lif-O-Gen Oxygen Device

Operation—simply pull the unit from the wall and oxygen will automatically begin flowing at 6 liters per minute; place the unit back in the cradle to stop the flow of oxygen, or alternatively, insert the attached regulator pin

Capacity—45 minutes from one refillable cylinder

Mounting—sturdy aluminum wall-mount cradle secures delivery system and mask assembly

Tank with Wall Mount	54520	\$514.00 ea.
Lif-O-Gen Wall Cabinet with Alarm	55608	\$459.00 ea.
Lif-O-Gen & AED Wall Cabinet with Alarm	54494	\$249.00 ea.

* Direct-ship item. Please allow additional time to receive.

C. AED Companion O2 UNIT LIFE® SoftPac

Six pound portable companion for your AED to provide emergency oxygen to a breathing victim before the onset of fibrillation, oxygen enriched CPR to a non-breathing victim, or continued supplemental oxygen after successful defibrillation. It features a constant reading supply gauge with simple full-to-empty symbols, shoulder strap, handle, and padded case for easy carrying with wall-mount hook. Disposable/replaceable (or refillable) cylinder, non-prescription, 40 minute supply @ 6 LPM. Shipped with cylinder full O₂ ready-to-use.

7½"W x 15"H x 4½"D

Adjustable Flow allows "High" setting for 100% inspired oxygen 6 and 12 LPM	*54034	\$322.00 ea.
Variable Flow (for EMTs) 12 flow settings: 0, 0.5, 1, 2, 4, 6, 8, 10, 12, 15, 20, and 25 LPM	*54035	\$322.00 ea.
Disposable or Refillable Cylinder	54384	\$187.00 ea.
Replacement Face Mask	54381	\$11.65 ea.
Replacement Hose for Face Mask	1002272	\$2.33 ea.

D. Boost Oxygen

Boost Oxygen is the #1 trusted brand of supplemental oxygen. In lightweight and portable containers, athletes at all levels of sport, youth to professional, trust 95% pure Boost Oxygen to support performance, recovery, and results. Approved for use during athletic competition. Made in USA, 100% recyclable, no propellants. Safe and natural for use by all ages. Patented mask design for maximum delivery.

5 Liters	1030435	\$10.99 ea.
----------------	----------------	-------------

FIND THE LIFE® OXYGENPAC EMERGENCY OXYGEN IN WALL CASE AND OTHER OXYGEN OPTIONS ONLINE!

 Not made with Natural Rubber Latex.

EMERGENCY RESPONSE & SAFETY

Suction Devices



Tactical Suction Device

This reliable, simple, rugged, and inexpensive suction solution is for clearing airway obstruction due to bloody fluids or other secretions. The device is designed to provide a vacuum force of approx. 100 mmHg generated by the rebound of the bulb after each squeeze. Evacuated contents are expelled into a clear collection bag attached to the outlet port. The valve vac's bag and bulb hold well over 1000mLs. A unique double-valved design allows for continuous operation with one hand.

.....**51179** \$41.15 ea.



Devilbiss Suction Pump

The DeVilbiss Suction Unit is a compact medical suctioning device which has been designed for reliable, portable operation. Because of the small size, light weight and DC operation, the DeVilbiss Suction Unit is ideal for providing suction.

Features:

- High Performance – Vacuum adjustments allow for 80-550 mmHg and a free flow of 27 LPM
- Adjustable Flow Regulator – Easy-to-turn knob conveniently placed directly below gauge for easy use and control
- Increased Battery Capabilities – For use up to one hour. Provides the patient with added security when needed most
- Easy-to-Read Gauge – The unit has conveniently placed gauge for easy reading, which is important when precise measurements of vacuum are needed for the pediatric patient
- Compact Design – All of the high performance capabilities are conveniently placed in a small compact package weighing less than 6.3 lbs

Devilbiss Suction Device**54134** \$504.50 ea.
 Yankauer Suction Device**54137** \$3.18 ea.
 Replacement Filter**54138** \$10.45 ea.



AMBU ResCue Hand-Held Suction Pump

The AMBU ResCue Suction Pump is a manual suction pump is a portable and lightweight, no power required. This suction pump is designed for quick, easy application. This manual pump is used for emergency pharyngeal or tracheal suction.

Ambu Res-Cue pump features:

- Adjustable: adults (100%), children (50%)
- Disposable collection canister (300ml)
- Adult and infant suction catheters included
- Fast and powerful stroke suction vacuum: up to 500 mmhg

Kit includes:

- Pump with one disposable canister
- Cap
- Disposal bag
- 2 suction canisters

Manual Suction Kit**54122** \$70.80 ea.
 Replacement Canister Kit.**54124** \$17.75 ea.
 Suction Device Carry Bag**54123** \$23.85 ea.



Laerdal® V-VAC™ Manual Suction Unit

The Laerdal Manual Handheld Manual Suction unit is a simple yet efficient suction unit for first responders, and a reliable backup for emergency healthcare providers. The V-VAC unit works the instant you squeeze it! One-hand operation.

Features:

- Adjustment for high- and low-pressure suctioning
- Efficient—maximum suction exceeds 380 mm Hg. Peak air flow over 70 liters per minute
- Features a unique no-clog suction tip (intake valve)
- Versatile catheter connection
- Disposable one-piece cartridge provides a new, clean pump, valve and suction tube
- Reusable handle is immersable for cleaning

.....**55148** \$139.00 kit
 Replacement Cartridge**55149** \$36.90 ea.



A



B



C



D

A. **School Health Brand Adult/Child/Infant Pocket CPR Mask in Hard Case**

The School Health Pocket CPR Mask is designed to offer superior protection for both rescuer and victim by combining a low resistance one-way valve with a 3M disposable hydrophobic filter to help prevent the passage of liquids and secretions.

Features:

- Oxygen inlet facilitates delivery of supplemental oxygen during ventilation of a non-breathing patient or for inhalation by a spontaneously breathing patient
- The pre inflated cuff is made from super soft plastic providing superior seal
- Superior protection through a one-way valve and filter
- Pre-inflated cuff for effective and good seal
- Oxygen inlet facilitates delivery of supplemental oxygen
- Head strap included
- Disposable one-way valve and filter
- Replacement filters available
- Includes gloves

.....**59701** \$7.99 ea.

B. **School Health Brand Face Shields**

Individually sealed in foil packets for convenient storage in wallet, purse or first-aid kits. Can also be used for manikin training.

10/box**55060** \$26.92 box

50/box**55182** \$111.00 box

C. **WNL CPR Masks**

These clear CPR mask allows the rescuer to position it properly and monitor the victim. The soft, pliable bladder ensures a secure seal. Mask can be used with the standard one-way valve for rescue or with the CPR Practi-VALVES during CPR manikin training. Mask may be cleaned and reused, but only for training purposes. Dispose of mask and valve after patient use.

Adult/Child, Hard Case**55269** \$8.99 ea.
 Adult/Child, Soft Case**55270** \$8.99 ea.
 Adult/Child/Infant, Hard Case**55271** \$10.99 ea.
 Adult/Child/Infant, Soft Case**55521** \$10.99 ea.

D. **School Health Brand Key Ring Face Shields**

Small in size and price, but big on protection when you need it! Comes in a small soft pouch with brass key chain. Plastic sheet and 3M Filtrete™ hydrophobic filter helps prevent possible contact with victim's saliva or blood; bi-directional filter with imprinted graphic directions for use; fits into pockets and first-aid kits. Assorted colors.

.....**55181** \$5.17 ea.



American Red Cross CPR Station

This bi-lingual CPR station designed for the American Red Cross is perfect for CPR preparedness.

Kit includes:

- (1) Backboard with mounting materials
- (4) CPR face shields with one-way valve
- (8) Exam quality vinyl gloves
- (4) Antimicrobial wipes
- (1) Biohazard Bag with twist tie
- (1) CPR card, English
- (1) CPR card, Spanish

CPR Station**57824** \$44.20 ea.

Not made with Natural Rubber Latex.

Bleeding Control Products



SH School Health Brand Trauma Kits

These advanced first aid kits are intended to treat life-threatening injuries while waiting for emergency crew to arrive. These kits can be used in an active shooter scenario, but also to prevent bleeding from injuries when a basic first aid kit may not suffice. See table below for contents.



Trauma Pak	59121	\$47.25 kit	Public Access Basic Kit with CAT, Nylon Bag	1035000	\$75.40 kit
Trauma Pak with CAT	1030430	\$96.30 kit	Public Access Intermediate with CAT, Resealable Bag	1035001	\$95.80 kit
Basic Bleeding Control Kit	59120	\$56.40 kit	Public Access Intermediate with CAT, Resealable Bag	1035002	\$72.95 kit
Basic Bleeding Control Kit with CAT	1030429	\$85.60 kit	Public Access Advanced with CAT, Resealable Bag	1034998	\$105.50 kit
Advanced Trauma Kit	56004	\$104.00 kit	Public Access Advanced with CAT, Nylon Bag	1034999	\$131.00 kit
Advanced Trauma Kit-CAT	1030428	\$136.00 kit			
Multiple Trauma Response Kit	54940	\$338.50 kit			
Public Access Basic Kit with CAT, Resealable Bag	1035004	\$67.20 kit			

SCHOOL HEALTH BRAND TRAUMA KITS CONTENTS													
	59121	59120	56004	1030428	54940	1030429	1030430	1035004	1034998	1034999	1035000	1035001	1035002
QuikClot	(1)		(1)	(1)	(3)		(1)		(1)	(1)			
SWAT-T Tourniquet	(1)	(1)	(1)	(1)	(3)	(1)	(1)						
CAT Tourniquet				(1)	(1)	(1)	(1)	(1)	(1)	(1)	(1)	(1)	(1)
H Bandage		(1)	(1)	(1)	(3)	(1)							
Compressed TACGauze		(1)	(1)	(1)	(3)	(1)		(2)	(2)	(2)	(2)	(2)	(2)
Mini Compression Bandage	(1)						(1)	(1)	(1)	(1)	(1)	(1)	(1)
Gloves	(1)	(1)	(1)	(1)	(1)	(1)	(1)	(2)	(2)	(2)	(2)	(2)	(2)
Permanent Marker			(1)	(1)				(1)	(1)	(1)	(1)	(1)	(1)
Instruction Card	(1)	(1)	(1)	(1)	(1)	(1)	(1)	(1)	(1)	(1)	(1)	(1)	(1)
Shears		(1)	(1)	(1)	(1)	(1)		(1)	(1)	(1)	(1)	(1)	(1)
2" x 2" Gauze	(1)						(1)						
4" x 4" Gauze	(1)						(1)						
Chest Seal			(1)	(1)	(3)				(1)	(1)	(1)	(1)	(1)
Hypo Blanket		(1)				(1)		(1)	(1)	(1)	(1)	(1)	(1)
Carrying Case	Vacuum Sealed	Vacuum Sealed	Nylon Bag	Nylon Bag	Nylon Bag	Vacuum Sealed	Resealable Bag	Resealable Bag	Resealable Bag	Nylon Bag	Nylon Bag	Nylon Bag	Resealable Bag

Bleeding Control Products



A. QuikClot Bleeding Control Dressings

QuikClot Bleeding Control Dressing stops bleeding of superficial wounds, minor cuts, and abrasions. Utilizing the same fast-acting technology adopted by the U.S. military for years to save lives, the Bleeding Control Dressing accelerates the body's natural clotting process using an inert, inorganic material impregnated into gauze that will not break down. The Bleeding Control Dressing helps blood clot up to five times faster, and it can control bleeding within minutes of application.

Z-Fold, 3" x 4 yd.....	52915	\$48.60 ea.
Roll, 3" x 4 ft.....	55470	\$27.80 ea.

B. Israeli Emergency Compression Bandage

The Israeli Emergency Compression Bandage is a wide, all-in-one bandage that consolidates multiple first-aid devices such as a primary dressing, pressure applicator, secondary dressing, and a foolproof closure to secure the bandage in place.

6".....	50029	\$10.25 ea.
4".....	50022	\$9.61 ea.

C. H&H "H" Bandage

The H-Bandage gives first responders both an emergency dressing and a hemostat for arterial bleeding and hemorrhaging in limbs.

8" x 10", Flat Fold.....	52991	\$8.65 ea.
--------------------------	--------------	------------

D. H&H Big Cinch Abdominal Bandage

This ABD Pad can cover the largest wounds and protects vital abdominal organs during a trauma scenario. The pad and the wrap ensure a tight fit to prevent slipping while gently protecting the abdominal region.

12" x 16".....	52990	\$11.35 ea.
----------------	--------------	-------------

E. H&H Chest Seal

Featuring easy-to-peel tabs, each DualSeal™ Chest Seal can be applied over an open wound or can be used to seal over a puncture chest wound.

3.75" x 3.75", 2/pkg.....	54942	\$21.30 pkg.
---------------------------	--------------	--------------

F. Hyfin Vent Compact Chest Seal

This two-vented chest seal is designed with three vented channels that allow air to escape the chest cavity during exhalation, but prevents airflow from entering through the injury site during inhalation.

4.75" x 4.75", 2/pkg.....	59942	\$13.30 pkg.
---------------------------	--------------	--------------



School Health Corporation offers two types of emergency tourniquet systems:

It is recommended to have one of each type to be fully prepared for any scenario.

Windlass—Used extensively by the U.S. Military due to its quick application and the lock system of the tourniquet which allows the user to know when the tourniquet is tight enough to stop the bleeding. These tourniquets also prevent from over-tightening, which can lead to nerve and soft tissue damage.

Elastic—These tourniquets are the standard in hospital settings. Elastic tourniquets are easy to use, cost effective and can stop hemorrhaging quickly and effectively. These tourniquets can also be used on pediatrics and on areas of the body that other tourniquets may not be as effective.

Windlass Tourniquets

A. Combat Application Tourniquet (C-A-T)

- Red Tip Technology elliptical tab provides visual cues during application
- Single Routing Buckle speeds up application, decreases blood loss, removes slack, requires fewer windlass turns, and simplifies training with single protocol application standard

Black.....	57780	\$30.50 ea.
Orange.....	57785	\$30.50 ea.

SOFT T Wide (Not Shown)

- A true 1½" constricting band for increased constricting pressure and patient comfort
- Quick-connect, snap-lock buckle design, allows rapid re-routing of the band around trapped limbs without rethreading

Black.....	56927	\$34.45 ea.
Orange.....	56928	\$34.45 ea.

B. SAM XT Tourniquet

- Durable nylon construction distributes force as targeted pressure for maximum strength and flexibility
- Innovative locking prongs automatically lock in when optimal tightness is met

Black.....	1030482	\$39.99 ea.
Orange.....	1030481	\$39.99 ea.

Elastic Tourniquets

C. Rapid Application Tourniquet (R.A.T.)

- Can quickly and effectively apply tourniquet with one hand
- Compact and durable design makes it easy to carry
- Locking system prevents it from loosening or slip over time

Black.....	59820	\$17.95 ea.
Orange.....	54550	\$17.95 ea.

D. SWAT-T

- Can be used as a tourniquet, pressure bandage, and an elastic wrap
- Compact and durable design makes it easy to carry
- Instructions printed on the elastic that indicate the level of pressure exerted

Black.....	57795	\$14.49 ea.
Orange.....	54902	\$14.49 ea.

Bleeding Control Products



THESE BLEEDING CONTROL KITS ARE AVAILABLE IN MANY DIFFERENT OPTIONS TO FIT YOUR SCHOOL!

Public Access Bleeding Control Stations

Basic—The Basic version of the NAR PABC Station provides eight complete kits in red nylon bags. Each one contains lifesaving bleeding control equipment, such as tourniquets, pressure dressings and gauze bandages, and puts them into the hands of the public to help control bleeding and save lives. It also includes the NAR Responder QuikLitter™ for moving injured casualties.

Intermediate—Includes all equipment found in the Basic PABC Station, with each of the eight complete red nylon kits also having the ability to treat penetrating chest wounds using the HyFin® Vent Compact Chest Seal Twin Pack (for entrance and exit wounds).

Advanced/Advanced BCD—Includes all equipment found in the Intermediate PABC Station, with each of the eight complete red nylon kits also providing the added capability of a hemostatic dressing to enhance blood clotting for faster bleeding control.

8 Packs in Nylon Bag

Basic	57781	\$879.00 kit
Intermediate	57807	\$1,079.00 kit
Advanced	57808	\$1,449.00 kit
Advanced BCD	52235	\$1,349.00 kit

8 Packs in Vacuum Sealed Bags

Basic	57805	\$829.00 kit
Intermediate	57782	\$849.00 kit
Advanced	57806	\$1,249.00 kit
Advanced BCD	52236	\$1,199.00 kit

5 Packs in Vacuum Sealed Bags

Basic	59190	\$619.00 kit
Intermediate	59191	\$699.00 kit
Advanced	59192	\$949.00 kit
Advanced BCD	59193	\$939.00 kit

Mobile Public Access Packs

Basic—The Basic version of the NAR Public Access Bleeding Control 5-Pack provides five complete kits containing lifesaving bleeding control equipment, such as tourniquets, pressure dressings and gauze bandages, and puts them into the hands of the public to help control bleeding and save lives. It also includes the NAR Responder QuikLitter™ for moving injured casualties.

Intermediate—Includes all equipment found in the Basic Public Access Bleeding Control Pack, with each of the five complete kits also containing the additional capability of treating penetrating chest wounds with the HyFin® Vent Compact Chest Seal Twin Pack (for entrance and exit wounds).

Advanced/Advanced BCD—Includes all equipment found in the Intermediate Public Access Bleeding Control Pack with each of the five complete kits also containing the additional capability of a hemostatic dressing to enhance blood clotting for faster bleeding control.

5 Packs in Vacuum Sealed Bags

Basic	59919	\$348.00 kit
Intermediate	59822	\$402.00 kit
Advanced	59823	\$648.00 kit
Advanced BCD	59824	\$642.00 kit

Individual Bleeding Control Kits

Basic—The NAR Individual Bleeding Control Kit provides lifesaving bleeding control equipment, such as tourniquets, pressure dressings and gauze bandages, and puts them into the hands of the public to help control bleeding and save lives.

Intermediate—Includes all equipment found in the Basic Individual Bleeding Control Kit, with the added capability of treating penetrating chest wounds with the HyFin® Vent Compact Chest Seal Twin Pack (for entrance and exit wounds).

Advanced/Advanced BCD—Includes all equipment found in the Intermediate Individual Bleeding Control Kit, with the additional capability of treating major bleeding with a hemostatic dressing to enhance blood clotting for faster bleeding control.

Vacuum Sealed Bags

Basic	57784	\$54.85 kit
Intermediate	57801	\$74.00 kit
Advanced	57802	\$118.50 kit
Advanced BCD	52237	\$115.50 kit

Nylon Bags

Basic	59935	\$65.90 kit
Intermediate	59936	\$110.50 kit
Advanced	59937	\$163.50 kit
Advanced BCD	52230	\$148.00 kit

School Officer Response Kit

The SRO Crisis Response Kit is designed to provide the School Resource Officer with the medical products to treat penetrating trauma and severe bleeding. Carrying this kit empowers an SRO to administer self-aid in the event he or she is injured or provide immediate care to injured casualties during a school incident

.....**59926** \$374.00 kit

NEW!



MORE ONLINE

For complete lists of contents for kits on this page go to: SchoolHealth.com/ER-kits

Get the SWAT-T

**Easy to Use - Low Cost
Proven for All Limb Sizes**



stop bleeding fast.



Mass Casualty 6-Pack Kits

These Mass Casualty Kits are secured in pouches so first responders can quickly “grab and throw” kits to other responders.

Basic Kit Contains:

- (1) SWAT-T Tourniquet
 - (1) H&H Compressed Gauze
 - (1) H&H Mini Compression Bandage
 - (1) Pair of nitrile gloves
- Kit in Vacuum Sealed Bag. **1031465** \$209.00 kit
 Kit in Nylon Bag **1031466** \$299.00 kit

Intermediate Kits Contains:

- (1) SWAT-T Tourniquet
 - (1) H&H Compressed Gauze
 - (1) H&H Mini Compression Bandage
 - (1) Pair of nitrile gloves
 - (1) Quick Clot Bleeding Control Gauze pack
- Kit in Vacuum Sealed Bag. **1031467** \$386.00 kit
 Kit in Nylon Bag **1031468** \$478.00 kit



Bleeding Control Kits

These compact and durable individual hemorrhage control kits treat bleeding from penetrating and other traumatic injuries. Each kit comes packed in a compact, rugged, resealable pouch.

Each Kit Contains:

- (1) SWAT-T tourniquet for hemorrhage control
 - (1) H&H Mini Compression Bandage for wrapping and providing pressure
 - (1) H&H Compressed Gauze Roll to pack and wrap a wound
 - (1) Pair of nitrile gloves to protect the first responder
- Intermediate kit also includes: QuikClot™ Bleeding Control Gauze
- Basic Kit **1031634** \$31.10 kit
 Intermediate Kit **1031635** \$52.55 kit

Emergency Kits

MobileAid® Trauma First Aid Station

Extensive next-generation, 260-piece mobile trauma first aid station that meets OSHA guidelines and ANSI standards; can be wheeled directly to any medical emergency — large or small.

This station is organized in quick-response first aid modules for rapid response and treatment, and includes a flexible evacuation stretcher. First aid supplies are designed to treat traumatic injuries. Unique dual-wheel design aides in rapid response and makes climbing curbs and stairs easy.

An integrated seat and gear platform allow the patient to sit and be treated or can be used to haul additional equipment (e.g. AED, oxygen tank, etc.). High visibility markings, flashing LED wheels, and an 8-foot extendable flag make the mobile station easy to spot in any situation.

Super-durable, light-weight frame construction (supports up to 300 lbs.) and heavy-duty weather resistant bag safeguard contents. Telescoping handle retracts for compact storage in less than 2 cubic feet (10" x 18" x 13").

All Terrain Trauma First Aid Station

.....**.56620** \$635.00 kit

The Sports First Aid Station contains supplies such as splints, tape, and cold packs.

.....**.42129** \$501.50 kit

Sports First Aid Station

.....**.42130** \$501.50 kit

Replacement Modules

Quick Response Pockets Module 1

.....**.42139** \$59.90 ea.

Protection, Instruments Sanitation - Module A

.....**.42140** \$69.00 ea.

Wound Cleaning & Treatment - Module B

.....**.42141** \$56.15 ea.

Wound Dressing & Bandaging - Module C

.....**.42142** \$56.15 ea.

Large Wound Dressing & Bandaging - Module D

.....**.42143** \$59.55 ea.

Hydration & Cold Application - Module E

.....**.42144** \$26.55 ea.

Sport Injury & Bandaging - Module S

.....**.42145** \$74.95 ea.

Accessories

First Aid Organizer Box Small without Label

.....**.42138** \$11.55 ea.

First Aid Organizer Box Medium without Label

.....**.42137** \$13.80 ea.

First Aid Flag Assembly

.....**.42136** \$38.55 ea.

First Aid Bag Only, Unassembled

.....**.42135** \$214.00 ea.

First Aid Bag Assembled: includes organizer boxes, no supplies . . .**.42147** \$342.50 ea.

Emergency Evacuation Flexible Stretcher

.....**.42146** \$45.35 ea.

Wall Mount with 4 mounting screws and 4 breakaway ties (Shown)

.....**.23033** \$26.30 ea.



The MobileAid All Terrain Trauma First Aid Station is a portable 260-piece Trauma First Aid Station that is ready to roll to any medical emergency!



MobileAid® Emergency Response Backpacks

The combination of a 4-Way Carry Backpack and a Mobile Rolling-bag Station:

- Reduces response time over distances
- Minimizes waste of energy in transport
- Maximizes the supplies delivered by a single responder
- Increases operational flexibility in all types of terrain
- 4-way carry backpack — backpack, shoulderstrap, hand straps, or ride on rolling stations

A. 260-Piece Emergency Trauma First Aid Kit (see SchoolHealth.com for list of supplies)

.....**.23023** \$543.50 ea.

B. AED Backpack (Supplies not included)

.....**.23022** \$226.00 ea.



MobileAid® Professional Trauma Station

This trauma station provides superior mobility, organization and functionality for the medical professional who needs the flexibility to carry his or her own unique medical aid supplies to an incident. The mobile station includes an integrated gear and seating platform, 5 Quick-Access utility pouches with customizable handle IDs and clear vinyl lids for easy supply identification, an 8-foot extendable first aid flag set, and flexible evacuation stretcher. Trauma Station does not contain supplies.

.....**.91093** \$426.00 ea.

MORE ONLINE

For more ER backpacks and a lists of contents go to: SchoolHealth.com/ER-kits

MobileAid® SchoolGuard™

Emergency Response

Your Best Response...



**MobileAid® SchoolGuard™
50-Student Trauma First Aid Kit**
..... 1033862 \$249.95 kit
Empty Bag .. 1033865 \$59.95 kit

MobileAid® SchoolGuard™ Grab-N-Go Trauma First Aid Kit
..... 1033864 \$99.95 kit
Empty Bag .. 1033863 \$46.99 kit



Life Secure Mobile Aid Reflex Emergency Backpacks

With improved organization, the LifeSecure Reflex is ideal for any emergency or disaster.

- High-capacity safety green emergency response 4-way-carry backpack: backpack, shoulder strap, hand straps, ride on MobileAid rolling stations
- Easy 4-Way-Carry: backpack (padded shoulder straps, sternum strap, and waist belt), shoulder strap, hand straps, or ride on MobileAid rolling stations
- Flexible quick-access organization: 1 main compartment with restraint straps and top and front access, 2 side compartments, and 14 internal pockets
- Large pull tab zippers for quick opening
- Four external flashlight/tool tubes
- Easy identification and enhanced safety: hi-visibility markings, reflective stripes and piping, and 24 pre-printed and customizable ID placards (EMS, EMT, AED, TRAUMA, TRIAGE, OXYGEN, NURSE, SAFETY, SEARCH & RESCUE, TRAINER, SPORTS, COACH, nine blank for customizing)
- Reflective stripes and piping enhance safety in low-light situations

- Durable protection for supplies: super durable, weather-resistant ballistic nylon for years of use in rugged conditions
- Made of super-rugged ballistic nylon for years of use in tough conditions
- Adjustable: adjustable shoulder straps, sternum strap, and waist belt; three adjustable internal restraining straps
- Large main compartment with straps, 2 side compartments, and 14 internal pockets provide flexible organization of emergency response supplies and equipment
- Increased mobility with Easy-Roll and MobileAid emergency kits

Trauma First Aid Backpack Kits

- A. Reflex 100, 218 Piece Kit*42195 \$353.50 kit**
- B. Reflex Pro First Aid Backpack with Clear-View Pouches, Supplies not included42197 \$223.00 ea.**

Incident Command Backpack Kits

- C. Reflex 200, 188 Piece with Megaphone* ...42198 \$349.00 kit**
- D. Reflex Pro Emergency Backpack with Clear-View Pouches, Supplies not included42202 \$207.50 ea.**

*Go to SchoolHealth.com for list of kit contents.

Emergency Kits



A



B



C



E



D

Comprehensive Rescue System

Modern supplies help you manage severe bleeding, cardiac arrest, allergic reactions, diabetic emergencies, fractures, and more. Diagnostic app provides “just-in-time” training to help untrained bystanders save lives.

Includes:

- | | |
|----------------------------------------------|-----------------------------------------|
| (4) SOFTT Wide® tourniquets | (1) 15 mg Insta-Glucose® |
| (2) Quickclot® bleeding control dressings | (2) Emergency space mylar blanket |
| (2) 6" NAR® emergency trauma dressings | (1) Portable charger and charging cord |
| (2) Hyfin® Chest Seal* | (1) USB charging cube |
| (2) Water-jel® universal burn dressings | (1) Inspection card |
| (2) Triangular bandages | (12) Proof seals |
| (2) 4.5" Sterile conforming stretch gauze | (2) Bags with biohazard markings |
| (4) 5" x 9" sterile conforming stretch gauze | (1) Trauma shears |
| (2) 10" x 30" sterile multi-trauma dressings | (10) Nitrile gloves |
| (1) 36" SAM® emergency splint | (16) Eye pads |
| (2) 4" Elastic wrap bandages | (10) Adhesive bandages (assorted sizes) |
| (1) 4" x 5" cold compress | (10) Burn cream packets |
| (1) Adhesive tape 2.5 Yd. | (10) Triple antibiotic ointment packets |
| (1) CPR face shield with bite block | (1) Antiseptic wipe |
| (1) Bottle 81 mg chewable aspirin | (10) Tweezers |
| (1) Box 12 mg dissolvable allergy tablets | (1) Hand sanitizer |
| | (1) Eye wash |
| | (1) First Aid Guide |

17.2"L x 13.7"W x 6.5"D, 15 lbs.

- A.** With Carrying Case **54721** \$2,299.00 kit
B. With Backpack **54722** \$1,999.00 kit

C. Public Access Rescue Station

Each iPAK Includes:

- | | |
|------------------------------------------|-------------------------------------|
| (1) SOFTT Wide® tourniquet | (1) CPR face shield with bite block |
| (1) Quickclot® bleeding control dressing | (1) Emergency space mylar blanket |
| (1) 4" NAR® emergency trauma dressing | (1) Trauma shears |
| (1) Hyfin® chest seal | (1) Public access care card |
| | (4) Pair nitrile gloves |

Carrying Case with 4 iPAKs, 14.5"L x 10.5"W x 6"D, 6 lbs.

- **54787** \$999.00 kit
iPAK, 7.5"L x 4"W x 3"D, 1 lb. **54741** \$225.00 kit

D. Compact Rescue System

Includes:

- | | |
|------------------------------------------|-------------------------------------|
| (1) SOFTT Wide® Tourniquet* | (1) CPR Face Shield with Bite Block |
| (1) QuickClot® bleeding control dressing | (1) Emergency space mylar blanket |
| (1) 4" NAR® emergency trauma dressing | (1) Trauma shears |
| (1) Hyfin® Chest Seal* | (1) Public access CARE card |
| | (4) Pair nitrile gloves |

- 7.5"L x 4"W x 3"D, 1 lb. **54786** \$299.00 kit

E. Mobilize Training Kit

Everything you need for emergency training, including severe bleeding, unconsciousness, CPR, AED application, rescue breathing for children & infants, trouble breathing, opiate (heroin) overdoses, hypothermia, seizures and choking.

- | | |
|------------------------------------------|--------------------------------------------|
| (1) SOFTT Wide® Tourniquet* | (1) Emergency space mylar blanket |
| (1) 4" NAR® Emergency Trauma Dressing* | (1) Trauma shears |
| (1) QuickClot® bleeding control dressing | (4) Pair nitrile gloves |
| (1) Hyfin® Chest Seal* | Online Classroom Training Handbook & Video |
| (1) CPR Face Shield with Bite Block | Access to the Mobilize Rescue App |

- **50323** \$199.00 kit

*For training purposes only

NEW!



LIFETIME WARRANTY ON ALL EVAC+CHAIRS



Evac+Chair 600H

Designed with 2 extra handles for locations with difficult access and 2 person operation. Blue textured finish with contrasting yellow hammock.

Includes:

- Patient restraints, wall mounted hooks, dust cover, photo luminescent signage and instructional DVD (a \$159.95 Value!)

Load Capacity: 400 lbs.

Width: 23", Fold Size: 47"H x 12"D x 23"W, 24 lbs. (unladen)

.....*59051 \$1,886.00 ea.

Evac+Chair 300H

Standard model Evac+Chair with 400 pound payload capacity. Blue textured finish with contrasting yellow hammock. Simple, single-person operation allows smooth descent down stairs using patented V-belt system.

Includes:

- Patient restraints, wall mounted hooks, dust cover, photo luminescent signage and instructional DVD

Load Capacity: 400 lbs.

Width: 20", Fold Size: 20"W x 41"H x 8"D, 19 lbs. (unladen)

.....*59049 \$1,599.00 ea.

Evac+Chair® Power 800

This electric/battery powered stair climber allows for easy and safe stair ascent and descent. Can be used in emergency evacuations, power outages, and daily patient transport to safely and easily move a passenger up and down a flight of stairs.

Includes:

- Battery charger (US/EU/UK), rechargeable battery, two keys, user guide, passenger headrest, passenger safety straps, photoluminescent wall sign, wall hooks, dust cover

Load Capacity: 350 lbs.

Folded Size: 19.5"W x 45"H x 10.6"D, 66 lbs.

..... 1035034 \$2,795.00 ea.



Stryker Evacuation Chair

- Essential for evacuation of disabled or injured persons from multi-level facilities in emergency situations.
- Innovative Stair-TREAD system enables one person to control movement down stairs without lifting.
- Extendable head and foot end lift handle design supports proper ergonomic lifting technique, while improving line of vision to feet and steps when lifting the chair on the stairs or over obstacles.
- Designed to maximize mobility in tight spaces.
- Folds to compact size for convenient storage.
- Exceeds fire safety requirements and emergency response guidelines established to support the Americans with Disabilities Act.

.....59035 \$3,999.00 ea.



Evacusafe Excel Chair

Lightweight and easy to set up for the mobility impaired. Once the chair is on ground level, the chair handles fold away and turn into a temporary wheelchair. With a supportive flat seat base, armrests, and padded headrest, the chair offers comfortable seating for extended periods of time.

- Friction-controlled track helps the chair glide smoothly down stairs under single-person operation
- Four wheels make the chair easy to maneuver
- Foot-operated brake and quick-release safety harness for secure, safe operation

Load Capacity: 400 lbs.

25.5"W x 52"H x 39"D (44.5"H x 11.5"D x 25.5"W Folded Size), 30 lbs. (unladen)

.....59101 \$1,795.00 ea.



ResQme Evacuation Sled

The ResQme is the most durable, portable, light weight and economical evacuation sled on the market. ResQme can be used for both small children and large adults. The ResQme allows the efficient, fast, safe and easy evacuation of a person down hallways, steps and to a area of safety.

- Built in pillow for comfort and protection
- Base board to protection against obstacles
- Pulling straps at both ends—can be pulled by one to four people
- Will slide on carpet, tile, vinyl, and concrete
- Can be used for children and adults up to 6'6"
- 4" wide Velcro® straps

.....*59074 \$385.00 ea.

* Direct-ship item. Please allow additional time to receive.

Stretchers & Immobilizer



A. Pole Stretcher

Rolls up for easy storage. Ideal as out-of-sight stretcher for schools, first aid closets and athletic events. Features a heavy-duty nylon cover and rugged rubber handgrips.

Load Capacity: 350 lbs.

83½"L x 23¼"W, 8 lbs. *59005 \$452.00 ea.

B. Fasl原因 Fullbody® Splint

A fast, effective, and comfortable vacuum immobilization at a budget-friendly price. It molds to the exact shape of each patient's body to support and immobilize, without applying the pressure that can lead to pressure sores and soft tissue damage. Using orange, semi-disposable FASPLINT® material on the front and gray, durable EVAC-U-SPLINT® material on the back, this splint is designed to be both budget-friendly and re-usable. It's the most cost-effective way to treat patients without sacrificing the best in care.

Features:

- Stabilizes a patient in the position most comfortable for them
- Provides full spinal immobilization from the head to the hips
- Alleviates pressure point pain and vastly increases patient comfort when used with any backboard, scoop stretcher or fabric flat stretcher
- Polystyrene beads insulate the patient to help maintain body temperature
- Economical, tapered design accommodates your budget and your storage space

Unfolded: 75.5"L x 29.5"W x 2"D (192 cm x 75 cm x 5 cm)

In Carry Case: 23"L x 24"W x 5"D (58 cm x 61 cm x 13 cm)

WEIGHT: Splint: 6 lbs. (2.7 kg) Splint, Case, and Pump: 10 lbs. (4.5 kg)

. 1007375 \$482.99 ea.

C. Folding Pole Stretcher

Folding cross spreaders and folding poles allow the stretcher to be folded together, both lengthwise and crosswise, to fit into minimum storage space. Stirrup legs keep patient off the ground.

Folds to 44¾" x 9¾"

90" Stretcher, 13 lbs. *59004 \$500.00 ea.

D. Ferno Full-Body Vacuum Mattress

The Full-Body Vacuum Mattress immobilizes the patient in a secure position as it conforms to any body shape. Three patient restraints with buckles to provide maximum patient security and six carry handles allow the splint to be used as a stretcher. Includes removable, contoured pillow and compact vacuum pump.

. *54773 \$772.50 ea.

* Direct-ship item. Please allow additional time to receive.

E. Evac-U-Splint® Adult Mattress

Molds to the contours of the patient's body without applying pressure, the vacuum mattress reduces pressure point tenderness. The mattress has padded handles secured to the perimeter of the mattress which provide security when moving and transferring a patient and also allow for users to share handles when handing off a patient in tight quarters.

Features:

- Extremely durable, easy-to-clean fabric
- Molds to each patient's unique body contours
- Reduces potential for nerve, vessel, and tissue damage
- Provides thermal insulation to maintain body temperature
- Ideal for injuries of the spine, back, hips, pelvis
- Quick connect and disconnect MaxiValve is easy to use, even with gloves
- X-ray compatible and MRI safe
- Patient can be transported in a supine, knees flexed, or a 30° elevated torso position

Load Capacity: 350 lbs., Unfolded: 78.75"L x 29.5"W x 2.5"D, Folded: 31.5"L x 28"W x 6" D in carrying case. Mattress, Case, & Pump: 16.75 lbs.

. 1007376 \$999.99 ea.

F. Combi Carrier II Scoop Stretcher

The Combi Carrier II functions as a scoop-type stretcher, minimizing patient movement with no logrolling required. The concave patient surface limits lateral movement of the victim, providing more secure stabilization. The split-litter design also allows for easy removal once the patient is on the ambulance cot or delivered to the emergency department, should that be desired to meet the latest protocols.

Features:

- Simple intuitive design minimizes training of all athletic training and EMS personnel
- Off-set sturdy latch is built for reliability and durability, making it much easier to apply and remove the device under patient load
- Can be separated at either end or split into two halves, eliminating unnecessary patient movement and making it ideal for patients with suspected hip, pelvic, and spinal injuries
- Clear center section provides unobstructed A/P view of the patient's spine
- Seamless, high-density polyethylene surface is easily cleaned and disinfected
- Quality components and no rivets, drive screws, or roll pins reduces maintenance and replacement costs
- Ideal companion product to the FASPLINT FULLBODY®, FASPLINT HALFBACK® or the EVAC-U-SPLINT® Mattress for a complete patient transfer system

. 1030423 \$1,113.00 ea.



A. Iron Duck Ultra Space Save

Innovative folding backboard is an ideal choice for tight spaces. Durable HDPE shell, exclusive stainless steel mechanical pivot, and internal aluminum runners make for a sturdy board you can rely on time and time again.

.....*59031 \$549.00 ea.

B. Laerdal® BaXstrap Spineboard

Incorporates the needs of the rescuer and patient into an ergonomically efficient platform for motion restriction.

- Extra-large, raised handholds make BaXstrap easy to grab, even with gloved hands
- Pins are molded into the board, maximizing their strength
- Includes strap holes for pediatric patients.
- Can be used in water
- Customized labeling available
- Radiolucent, MRI, and CT scan compatible

72"L x 16"W x 2½", 13.5 lbs.

.....*55170 \$246.00 ea.

C. Tri-Fold Blue Backboard

Features:

- Folds in three sections for compact storage
- Lightweight aluminum construction
- Blue powder coat frame and patient surface
- Easy to deploy
- Durable, large hand holds for easy access

.....*55971 \$866.00 ea.

D. Iron Duck Base Board

Features:

- Offers the leading strength and safety in its weight class
- Made of high-density polyethylene for durability and easy cleaning
- Fourteen oversized hand holds can accommodate gloved hands
- X-ray and CT scan translucent, MRI scan compatible applications

Weight Capacity: 500 lbs.

72" x 16" x 1.75", 16 lbs.

.....59033 \$200.00 ea.

E. Iron Duck Body Loc

This innovative Body-Loc strapping system is ideal for first responders in the public and industrial markets, using color coded straps for easy and efficient patient immobilization.

.....*59029 \$199.00 ea.

F. Iron Duck Ultra-Vue®

- Lightweight and x-ray transparent
- Made of molded, recyclable HDPE with a tapered board design
- Oversized hand holds measure 2" x 6"
- Molded pods on bottom of board for easy lifting
- Restraint straps sold separately
- 100% lifetime warranty

Load Capacity: 600 lbs.

72"L x 16"W x 1.85"H, 14 lbs.

Without Pins*59011 \$229.00 ea.

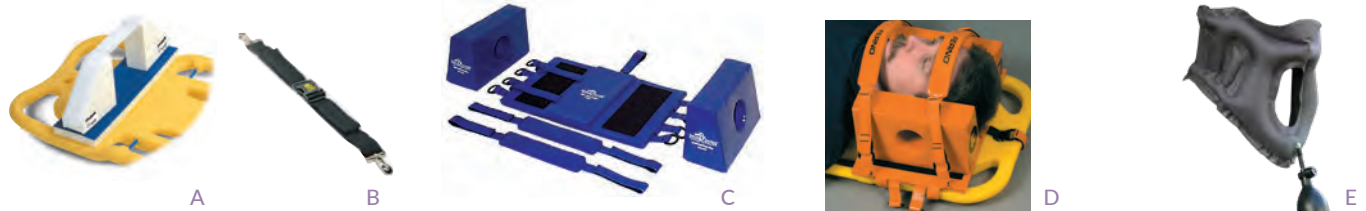

A. Laerdal® Sta-Blok® Head Immobilizer

Helping improve efficiency with low-cost disposable devices. Amazingly easy to use, compact, and effective. Soft, closed-cell foam. Fits virtually any patient on any backboard. Easy-to-adjust Velcro® padded head strap.

.....55171 \$7.91 ea.

B. Spineboard Straps

All straps are two pieces, totaling five ft. in length, with dual-side release DELRIN® buckles.

.....55172 \$18.75 ea.

C. Sof-Loc Head Immobilizer

Features two vinyl-coated head blocks with ear holes. Blocks attach to the mounting base that secures to all standard backboards. Patient's head is secured with forehead strap and chin strap. Includes two head Blocks, one mounting base, one head strap, and one chin strap.

16"L x 10"W x 6½"H.....59030 \$221.00 ea.

D. Ferno Head Immobilizer For All Stretchers

Conforms to any type of wooden or aluminum long backboard. Ear holes allow ear monitoring for possible bleeding. High-density foam head pads are comfortable and supportive. The vinyl covering makes it easy to clean and maintain. No metal hooks or buckles to interfere with x-rays.

2 lbs. 4 oz.59019 \$226.00 ea.

E. OTEC Aer Cervical Collar

Represents the latest technology in cervical spinal immobilization for austere environments, offering lighter weight, smaller packability, and greater performance when compared to leading industry competitors. Packable size allows for easy carry and storage (2.4 oz.). Chin strap provides intuitive placing and comfort of collar. Easy and secure latching allows for varying sizes. Air batters create structure while maintaining critical blood flow to the brain. Durable 75d Ripstop Nylon is strong for most situations and environments.

..... 1033835 \$63.99 ea.

Not made with Natural Rubber Latex.

* Direct-ship item. Please allow additional time to receive.

Wheelchairs & Transport Chairs



A

School Health Brand Wheelchairs

School Health's wheelchairs fit comfortably in a budget without sacrificing quality.

- Carbon steel frame with chrome plating
- Embossed upholstery
- Composite wheels
- Swing-away detachable footrests
- Limited lifetime warranty



B

A. School Health Brand Premium Wheelchair with Swing-Away Detachable Elevating Leg Rest

18" Wide Seat, 300 lb. Capacity
**10026** \$375.00 ea.

B. School Health Brand Economy Wheelchair

- Black, steel frame
- Detachable, elevating leg rests
- Swing-away, removable desk-length arms
- Warranty stated above

18" Wide Seat, 300 lb. Capacity
**10029** \$299.00 ea.



C

C. The Traveler SE Wheelchair

The Traveler SE incorporates the legendary Everest & Jennings® wheelchair frame with saddle-joint tubular construction and the latest industry standard front rigging. This wheelchair comes in a hammer tone finish and provides the most effective combination K0001/K0002 wheelchair available.

Standard features:

- Black vinyl upholstery
- Chart pocket on back
- "Tool Free" adjustable front rigging
- 250 lb. weight capacity
- Hammer tone paint provides a long-lasting and durable finish
- Industry compatible front rigging
- Two-position axle and caster fork
- 2" seat height adjustment

18" Wide Seat, 250 lb. Capacity Adjustable Footrests**10034** \$415.00 ea.

Elevating Leg Rests ..**10035** \$430.00 ea.

16" Wide Seat, 250 lb. Capacity Adjustable Footrests **10052** \$415.00 ea.



Transport Chairs

Features a durable, lightweight aluminum frame, fold-down back, and footrest extension.

- Weighs only 19 lbs.
- Aluminum frame is lightweight and strong
- Composite, 8" wheels are lightweight and maintenance free
- Come with swing-away footrests
- Comes with seat belt for added safety
- Padded armrests provide additional comfort
- Nylon upholstery is comfortable, lightweight, and easy to clean, back folds down for storage and transport
- Aluminum casted back-release hinge allows back to fold down for easy storage and transport
- Limited lifetime warranty

Small Chair (17")

Seat Area: 17"W x 16"D,
 Overall Width: 20"H (open) 9"
 (closed), Overall Length: 33",
 Overall Height: 39.5", Seat to Floor
 Height: 19", Chair Weight: 19 lbs.,
 Load Capacity: 300 lbs.

- Red.....***10059** \$204.99 ea.
- Blue.....***10062** \$204.99 ea.
- Black....***10054** \$204.99 ea.

Large Chair (19")

Seat Area: 19" W x 16"D,
 Overall Width: 22"H (open) 9"
 (closed), Overall Length: 33",
 Overall Height: 39.5", Seat to Floor
 Height: 19", Chair Weight: 19 lbs.,
 Load Capacity: 300 lbs.

- Red.....***10061** \$204.99 ea.
- Blue.....***10063** \$204.99 ea.
- Black....***10056** \$204.99 ea.



* Direct-ship item. Please allow additional time to receive.



A. Universal Single Tube Crutch

Features:

- Universal single tube steel crutch
 - Large tip helps provide greater surface contact
 - Detaches for easy storage!
 - Patient range: 4'6"-6'6"
 - Weight capacity: 400 lbs.
- | | | |
|----------------------------------------------------|----------------|-------------|
| Single Tube Crutch, Replacement Tips, Pair | 1003333 | \$32.75 pr. |
| Single Tube Crutch, Replacement Arm Cushions, Pair | 55815 | \$10.55 pr. |
| Single Tube Crutch, Replacement Arm Cushions, Pair | 55814 | \$10.60 pr. |

B. iWALK 2.0

iWALK 2.0 is a hands-free crutch alternative and a really simple idea. Conventional crutches use your hands and arms to support your weight, while the iWalk medical crutch uses the uninjured parts of your leg to support your weight when you stand or walk.

- Hands-free, pain-free mobility
 - Self-sufficiency through use of their hands
 - The ability to lead functional lives again
 - End the underarm, hand and wrist pain from conventional crutches
 - Ability to navigate stairs with ease and safety
 - Efficiency of walking due to using their legs for support instead of their hands and arms
 - Heightened well-being due to retaining an active, productive lifestyle
- | | | |
|--|----------------|--------------|
| | 1003625 | \$181.50 ea. |
|--|----------------|--------------|

C. Millennial Ergonomic Crutch

- Underarm Cradle
- Larger area enhances sense of walking stability
- Reduces underarm fatigue and soreness
- More comfortable to use Ergonomic Grip
- Natural relaxed hand position
- Maximizes blood flow
- Reduces carpal tunnel syndrome
- Eliminates numbness and tingling
- Push Pin Design
- Stores under the seat at a restaurant or in the overhead compartment on a plane

Gray, Short, 4'7"-5'6"	45029	\$129.99 pr.
Red, Short, 4'7"-5'6"	45030	\$129.99 pr.
Blue, Short, 4'7"-5'6"	45031	\$129.99 pr.
Gray, Tall, 5'7"-6'10"	45032	\$129.99 pr.
Blue, Tall, 5'7"-6'10"	45034	\$129.99 pr.
Gray, X-Tall, 5'11"-7'2"	45035	\$149.99 pr.

D. The Hope Crutch™

- Superior to conventional crutches
- More stable, much safer
- Two points of contact with each crutch—(1) behind the shoulder and (2) the hand—prevent the crutch from slipping
- Helps prevent nerve damage, heart & blood circulation problems
- Saves energy, improves range, & eliminates underarm irritation
- Easier to learn, easier to use
- Your body moves like the pendulum on a clock, with arms, & spine straight
- Reduces stress on wrist, elbow, rotator cuff, and spine
- Used by professional and collegiate athletes
- Benefits more people, speeds recovery
- Ergonomic handle
- Easy 1" height and handle adjustments for a correct fit

Medium, 5'2"-6'	45010	\$179.99 pr.
Large, 6'-6'8"	45011	\$179.99 pr.
X-Large, 6'8"-7'	45021	\$199.99 pr.

E. Aluminum Crutches

Aluminum push-button adjustable crutches. Load capacity: 275 lbs. Sized by user height. Includes all pads and tips.

Small, 4'6"-5'2"	45003	\$36.20 pr.
Medium, 5'2"-5'10"	45008	\$36.20 pr.
Large, 5'10"-6'6"	45004	\$36.20 pr.

Aluminum Cane (Not Shown)

Adjustable 30" to 38"	45005	\$19.99 ea.
-----------------------	--------------	-------------

Accessories for All Crutches

Cushions, tips, and grips are sold by pairs or a complete set of three (one pair of each).

Crutch Cushions	57491	\$7.48 pr.
Large Crutch Tips	57490	\$7.26 pr.
Crutch Grips	57493	\$7.06 pr.
Complete, Set of 3	57492	\$13.90 set

Finger Splints



Protecto Splints

Easily applied, this plastic splint and finger protector is most effective when used as an anterior and posterior support. It is washable and may be x-rayed. Width is 3/4".

- 20' Roll**20011** \$22.30 roll
- 7" Pre-Cut Strips, 25/dispenser box
.....**20010** \$25.10 box



Val-Guard Fingertip Protectors

- Small, 1/2" x 4"
10/box**20066** \$43.65 box
- Medium, 1/2" x 6"
10/box**20067** \$44.35 box
- Large, 1/2" x 7"
10/box**20068** \$45.95 box
- One size fits all.
10/box**20069** \$42.70 box



Strip-Splints

Formed with aluminum and cushioned with open cell foam. Splints can be easily shaped and cut with ordinary scissors. Available in 18" lengths. Non-allergenic; non-irritating.

- 12/box
- 1/2".....**20085** \$22.65 box
- 3/4".....**20000** \$25.20 box
- 1"**20001** \$26.10 box

Not made with Natural Rubber Latex.



Finger Splint Pack

This handy finger splint pack includes an assortment of plastic-coated, foam-padded, aluminum finger splints. Each pack contains 45 finger splints, three of each size.

- 45/kit**20035** \$189.00 kit

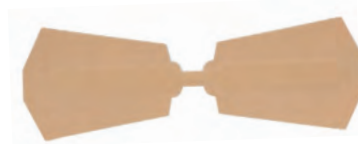

Powersplint

A sports finger protector guard that athletes wear during competition to protect from jams, breaks, dislocations, tendon injuries, and more. PowerSplint provides solid finger support while staying out of the way! PowerSplint is impact resistant, while allowing for a full range of finger motion. PowerSplint is comfortable, safe to wear, and washable. (Not indicated for thumb injuries.) The side wings flex inward or outward to adjust to various finger widths.



Pro-Ferred™ Finger Splint

Stiff enough for proper protection. Won't create rubbing rashes on adjacent fingers. Metal-free—doesn't interfere with x-ray machines or metal detectors. Won't get caught in pillows or blankets like metal splints can, which could irritate the injured finger. Disposable.

- Small, 12/pkg.**20173** \$29.90 pkg.
- Medium, 12/pkg.**20174** \$29.90 pkg.
- Large, 12/pkg.**20175** \$29.90 pkg.



A

A. Plastalume® Finger Splints

Made of malleable aluminum with 1/4" soft live foam that can be shaped easily for any use.

- Ball-shaped end prevents splint from rolling out of position and helps conform to finger
- Vinyl covering encases aluminum and cleans easily
- X-ray safe, eliminating need for re-splinting

Splints come in nine assorted sizes, three of each size.

- 27/box.**20009** \$52.60 box
- Splints come in nine assorted sizes, three of each size, plus 13 of the most popular splints.
- 40/box**20007** \$71.25 box
- Splints packaged in a plastic, hinged dispenser with nine assorted sizes, six of each size.
- 54/box**20008** \$112.00 box



B

B. Stax Finger Splints

Used for mallet finger and as a protective guard for fingertip or nail bed injuries. Designed to support the distal joint in extension with unrestricted movement of the proximal joint. Thirty-piece set in a carrying case.

- 30/kit**20073** \$69.40 kit

Replacement Splints

- #2.**20088** \$4.99 ea.
- #3.**20089** \$4.99 ea.
- #4.**20090** \$4.99 ea.
- #5.**20091** \$4.99 ea.
- #5 1/2.**20092** \$4.99 ea.
- #6.**20093** \$4.99 ea.
- #7.**20094** \$4.99 ea.

Measure from base of finger (web space) to the fingertip.			
	Size	Black	Blue
Sm	1 1/4"-2 1/4"	57550	57551
Med	2 1/4"-2 3/4"	1005990	1005987
Large	2 3/4" +	1005988	1005989
All Sizes.....\$18.99 ea.			



A. Fasplint Extremity Splint Set

This semi-disposable vacuum splint provides secure immobilization without circumferential pressure, eliminating the potential for tissue, vessel, and nerve damage. Unlike air and board splints, the FASPLINT molds to the contours of the patient's injury, so even difficult fractures and dislocations can be stabilized easily and quickly with a level of comfort that is unmatched by any other splinting technology. If ease of use and quality care are important issues for your service, then the FASPLINT deserves serious consideration. 3 Splint Kit with pump and rectangular case.

Features:

- Molds to exact shape of injury site, without applying circumferential pressure
- Reduces nerve, tissue, and vessel damage
- Economical: If a FASPLINT is lost, or is too soiled to be used again, the replacement cost is minimal

Fasplint, Extremity Splint Kit

(Includes: Small, Medium, and Large).	1007374	\$294.99 kit
Small, 19.5" x 14" (50 cm x 33 cm), FS 802-10	1007371	\$23.99 ea.
Medium, 27.5" x 20" (70 cm x 51 cm), FS 803-10	1007372	\$35.99 ea.
Large, 40" x 30" (102 cm x 76 cm)	1007373	\$48.99 ea.

B. Flex-All Splint

One splint with universal applications; fold it, mold it, bend it, curve it, cut it, and shape it to the desired configuration and size. The Flex-All Splint is lightweight, waterproof, radiolucent, and works on just about any part of the body.

36" x 4 1/4"	20179	\$12.80 ea.
------------------------	--------------	-------------

Soft Shell™ Splints

Rectangle of "O" temper aluminum encased in soft foam. The skin contact side has open-cell foam for permeability of vapor and moisture. The contact surface is covered with an absorbent brushed terrycloth, and the non-skin surface is overlaid with Velcro® friendly material.

Multi Size 6-Pack (two 9", two 12", two 15")	20212	\$131.50 pkg.	Multi Size XL 6-Pack (two 9", two 12", two 15")	20263	\$147.00 box
9"	20218	\$23.10 ea.	XL 9"	20264	\$23.55 ea.
12"	20224	\$23.45 ea.	XL 12"	20265	\$24.99 ea.
15"	20245	\$37.99 ea.	XL 15"	20266	\$37.99 ea.

C. Sam® Splints

Sam Splint is the lightweight, universal splint that can be used on just about any part of the body. Made of flexible aluminum with foam padding. Sam® Splints gain rigidity as they are formed.

Gray	Orange
36" x 4 1/4"	36" x 4 1/4"
. 20072 20226
\$24.50 ea.	\$24.20 ea.
18" x 4 1/4"	18" x 4 1/4"
. 20082 20186
\$15.80 ea.	\$15.70 ea.
9" x 4 1/4"	9" x 4 1/4"
. 20083 20227
\$6.73 ea.	\$6.71 ea.

D. Evac-U-Splint® Extremity Splint Set

Set of three splints provides a solution to almost every conceivable splinting situation. From dislocated shoulders to angulated wrist fractures, simply grab the vacuum splint, form it around the injured area, and evacuate the air.

Features:

- Extremely durable, easy-to-clean fabric
- Molds to exact shape of injury site without applying circumferential pressure
- Reduces potential for nerve, tissue and vessel damage
- Quick connect and disconnect MaxiValve™ is fast, effective and easy to use even with gloves on
- Simple, intuitive MaxiValve is extremely reliable and is guaranteed for the life of the product

Extremity Splint Set, Stored in Carry Case

24" x 11" x 11" (61 x 28 x 28cm)	1007370	\$679.99 set
Splints		
Small, 19.5" x 13" x 1" (50 x 33 x 2.5cm)	1007367	\$109.99 ea.
Medium, 27.5" x 20" x 1" (70 x 51 x 2.5cm)	1007368	\$134.99 ea.
Large, 40" x 30" x 1" (102cm x 76cm x 2.5cm)	1007369	\$189.99 ea.

E. Cramer Rapid Form™ Vacuum Immobilizers

Completely immobilize fractures and dislocations in original position without the circumferential pressure of air splints. The hand held pump creates a vacuum, conforming the splint to any shape in seconds. Pumping air back into the splint loosens it for removal and reuse. Splints can be worn during x-ray. All sets include pump, straps, and carrying bag.

Splints

Leg	20060	\$423.99 ea.
XL Leg	20135	\$459.99 ea.
Arm	20050	\$322.99 ea.
Ankle	1002269	\$334.99 ea.

2 Pc Set (Arm, Leg, Pump, Straps and Bag)	20096	\$589.99 set	Limb Set (Arm, Leg, XL Leg, Pump, Straps and Bag)	20222	\$914.99 set
3 Pc Set (Arm, Leg, Ankle, Pump, Straps and Bag)	20036	\$739.99 set	Brass Pump	20061	\$124.99 ea.
4 Pc Set (Arm, Leg, XL Leg, Ankle, Pump, Straps and Bag)	20221	\$1,064.99 set	Hose Assembly	20062	\$57.99 ea.
Deluxe Set (2 Arm, 1 Leg, Pump, Straps and Bag)	20220	\$789.99 set	Carrying Bag	20064	\$87.99 ea.

Not made with Natural Rubber Latex.

Splints & Slings

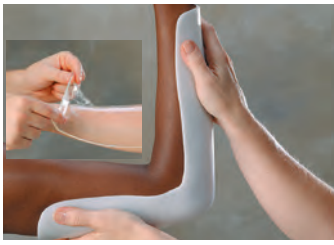

A



B



C



D

A. AquaPlast®-T Splinting Material

100% memory allows repeated reheating and economical splint revisions. 19% OptiPerf perforation pattern provides superior ventilation for comfort while maintaining material strength and easy edge finishing. 13% UltraPerf perforation pattern is ideal for lightweight finger or hand splints requiring breathability.

1/8" x 18" x 24"	20097	\$174.99 ea.
3/16" x 18" x 24"	20098	\$209.99 ea.
1/16" x 18" x 24"	20099	\$179.99 ea.
3/32" x 18" x 24"	20100	\$139.99 ea.

B. Cardboard Folding Splints

Splints have 3/8" punch-out holes for tie down straps. 3/8" foam covers entire splint. Micro Perf™ edges to protect from paper cuts on cardboard.

12"L x 9"W	20176	\$3.50 ea.
18"L x 9"W	20177	\$4.52 ea.
24"L x 14"W	20178	\$5.57 ea.

C. Reusable Arm Splints

Rigid, lightweight, sponge-like splint provides comfort and stability. Made of a thick, water-proof vinyl cover encasing a hard board and cushion.

Child, 3" x 9"	20051	\$2.45 ea.
Adult, 3" x 18"	20049	\$2.75 ea.

D. SpeedSplint™

Fits most adult and child arms and legs. Can be cut to required size for fit and comfort even during x-rays. Store flat and compact, or hang up for quick access. For application with standard first-aid bandages. Straps not included.

.	20029	\$18.50 ea.
-----------	--------------	-------------



COMPARE & SAVE!



A



B



C

A. School Health Brand Triangle Bandage Arm Sling

- Non-sterile, individually packaged
- Includes two safety pins
- Conveniently unfolds for arm sling
- Ideal for EMS and First Aid Kits

36" x 36" x 51"	27549	\$1.15 ea.
---------------------------	--------------	------------

B. Joslin Ultimate Arm Sling

Made of soft, breathable cotton spandex fabric that is lightweight and soft to the touch. Two full fabric loops, one for the thumb and one for remaining fingers, keep the hand securely inside the sling pouch. Designed to hold arm as gently as possible, reduces neck fatigue, and pressure on the elbow and wrist. Machine washable.

Child/Small	1006905	\$24.99 ea.
Adult, 5'-6'	20157	\$25.99 ea.
Adult, 6'-6'7"	20158	\$27.99 ea.
Goliath, 6'7"+	20162	\$58.99 ea.
Immobilizer		
Child/Small	20299	\$22.99 ea.
Adult	20159	\$25.99 ea.
Goliath	20161	\$31.99 ea.

Not made with Natural Rubber Latex.

C. Arm Slings

Places weight on shoulder instead of neck. Made of denim material and adjusts to either arm.

Adult, Open	20191	\$11.25 ea.
Adult, Closed	20192	\$11.25 ea.
Child, Open	20190	\$11.25 ea.
Child, Closed	20193	\$11.25 ea.

Disposable Adult Arm Slings (Not Shown)

Economical muslin envelope arm sling with adjustable sliding buckle for easy application.

Small, 10" x 6"	20040	\$7.55 ea.
Medium, 12½" x 7½"	20041	\$7.55 ea.
Large, 15" x 9"	20042	\$7.55 ea.
X-Large, 17½" x 10½"	20043	\$7.55 ea.



A



B



C



D



E



F

A. ThunderBolt X2® Lightning Detector

Professional-grade storm and lightning detectors detect lightning and track storms from 25 miles and are designed for rugged outdoor use!

Features:

- Detection of both cloud-to-ground and intra-cloud activity
- Color LCD display gives up-to-date information on storm status
- Rugged ABS plastic construction
- Water resistant when used with the included rubber grip
- Accurate within a 25 mile (40 km) range
- English/Spanish language support
- Unparalleled false disturber rejection, minimizing false detections
- Long operating times (>3 days) on a single set of "AA" batteries.
- Auto calibration
- Warning light, audible alert, and vibration notifications
- Temperature range from -40C to 85C
- 1 year manufacturer warranty

Specifications:

3" x 5.5" x 1", Batteries: Two "AA" batteries required.

Thunderbolt X2 **1006004** \$524.99 ea.

Thunderbolt X2 with Accessory Package

Accessory Package Includes: Carry Pouch/Aquapac/Two "AA" Batteries.
..... **1006005** \$551.99 ea.

B. Wet Globe Kit

The Wet Bulb Globe Temperature Index accounts for the impact that direct sunlight has on the human body. The WBGT Index combines wet and dry temperatures with a "Black Globe" temperature to accurately reflect the current risk. Hotbox is housed in a rugged aluminum case functionally identical to the kit supplied to the U.S. military. Guidelines included.

Unit with Tripod **61252** \$399.99 kit

C. Digital Sling Psychrometer Precision Temperature & Humidity Instrument

More accurate than analog technology, no water necessary, no twirling, F/C switch, low-battery indication, wet bulb & dry bulb temperature, dew point measurement. Two "AAA" batteries included.

- Measuring range: -20°C to 50°C (-4°F to 122°F)
- Accuracy: ±3% at 25°C (77°F) from 10% to 90% RH
- Humidity: ±4% all other ranges RH
- Temperature: ±1°C, 1°F (all temp. ranges)

..... **61145** \$146.99 ea.

D. StrikeAlert Lightning Detector

Provides early warning of strikes from as far away as 40 miles. An audible alarm sounds when there's a strike and an LED light illuminates at lightning distances of 20–40 miles, 12–24 miles, 6–12 miles, and 6 miles. Uses one "AA" battery (included).

..... **90427** \$126.99 ea.

E. Sling Psychrometer

Corrects air volume to standard conditions and determines relative humidity.

..... **61021** \$319.99 ea.

Replacement Thermometer **61032** \$101.99 ea.

F. Mannix Digital Psychrometer

Rotating head to protect sensor, field calibratable, auto power off.

Displays: Dew point: -90.4° to 122°F (-68-49.9°C)

Temperature, humidity, dew point, wet bulb Wet bulb: -69° to 122°F (-21 to 49.9°C)

Replaces LAM880D Temp. accuracy: ±10°F (±0.6°C)

Temperature range: -4° to 122°F (-20° to 50°C) Resolution: 0.1°; 0.1% RH

Humidity: 0 to 100% Response time: 60 sec.

..... **61698** \$133.99 ea.

Weather Monitoring



A

B

C

D



E



F



G



H

Kestrel 5400 Heat Stress Tracker

The Kestrel 5400 is revolutionary in size, cost, and capability for those in need of measuring heat stress. Available with or without LiNK (Bluetooth) and/or a compass.

Features:

- Wet Bulb Globe Temperature (“WBGT”)
- Thermal Work Limit (“TWL”)
- Waterless! Natural wet bulb temperature accurately calculated from on-board digital sensors with no tedious setup or maintenance.
- Large, hi-res, hi-contrast, graphic display is perfectly readable in the brightest sunlight and is backlit for use in low-light conditions.
- Wind speed
- Altitude
- Pressure trend
- Barometric pressure
- Relative humidity in %
- Heat stress index
- Dewpoint
- Air, water, and snow temperature
- Waterproof and floats
- Data logger
- Customizable data storage—2900 data points
- Graph and recall trends
- User-replaceable impeller
- Meets MIL-STD-810F 516.5 Procedure IV Transit Shock test—20 drops from 5 ft. IP-67 sealed to exclude dust and water at 3 ft. submersion
- Five languages (English, French, Spanish, German, and Italian)
- Made in the USA
- 5-year warranty

Includes: neck lanyard, “AA” Lithium battery, protective drawstring pouch, certificate of conformity, instruction manual.

Orange	1031519	\$499.00 ea.
A. Orange with Mount	1031520	\$549.00 ea.
Orange PRO with LiNK + Vane Mount	1031517	\$639.00 ea.
Tan with Mount	1031521	\$549.00 ea.
B. Tan PRO with LiNK + Vane Mount	1031518	\$639.00 ea.
Accessories		
C. Kestrel Collapsible Tripod	1031528	\$89.99 ea.
D. Kestrel Portable Mini Tripod	1031530	\$36.49 ea.
Kestrel Tripod Clamp	1031529	\$14.24 ea.

E. Extech Heat Stress WBGT Meter

Wet Bulb Temperature (WBGT)—considers the effects of temperature, humidity, and direct or radiant sunlight.

- Heat Stress Index measures how hot it feels when humidity is combined with temperature, air movement, and radiant heat
- Black Globe Temperature (TG) monitors the effects of direct solar radiation on an exposed surface
- Selectable units of °F and °C
- In/Out Function displays the WBGT value with or without direct sun exposure
- Built-in RS-232 interface with optional Windows® compatible software
- Complete with two “AAA” batteries

Specifications:

Wet Bulb Globe Temperature (WBGT): 32°-122°F (0°-50°C), ±4°F/2°C	Air Temperature (TA): 32° to 122°F (0° to 50°C), ±1.8°F/1.0°C
Black Globe Temperature (TG): 32° to 176°F (0° to 80°C), ±4°F/2°	Humidity: 0 to 100%RH, ±3%RH
	Weight 4.8 oz.

.....**91482** \$306.99 ea.

F. Temperature & Humidity Pen

Displays temperature and humidity. Features: Min/max memory, F/C switch, and data hold. Fast response and high accuracy. Battery included.

5.9" x 0.8" x 0.6"**61579** \$106.99 ea.

G. Precision Heat Index Instrument

Displays heat index, temperature, humidity, and dew point. Danger icon has an audible beep when heat index becomes potentially dangerous.

.....**61253** \$142.00 ea.

H. DataTherm II Continuous Temperature Monitor

Incorporate the DataTherm II Continuous Temperature Monitor for accurate and effective core body temperature assessment in your prevention and treatment of Exertional Heat Illness.

.....**13119** \$429.00 ea.



**RDX Series
Two-Way
Radios**

A

RMU2040
RDU4100



B

RDU2080d
RDU4160d



C



D

A. 2 Watt Models

- Rugged, durable and loud with 4 times the audio output
- Coverage up to 250,000 sq. ft.
- 89 Frequencies for secure conversations
- RDU2020 has 2 channels
- RDU2080d has 8 channels, with display indicating battery life, channel, name of user and different groups
- Includes desktop charger, belt clip, rechargeable Li-Ion battery
- Also available in VHF - call for information

4.5"H, 8.6 oz.

RDU2080d	55714	\$290.00 ea.
RDU2080d	19081	\$333.50 ea.
2 Watt Li-Ion Battery	19061	\$76.50 ea.
6 Unit Charger	19085	\$260.50 ea.

B. 4 Watt High Power Models

- Highest power for best coverage in large buildings
- Includes features of 2 watt models and more
- Coverage up to 300,000 sq. ft.
- RDU4100 has 10 channels
- RDU4160d has 16 channels, with display indicating battery life, channel, name of user and different group
- Programmable to use with repeaters, base stations, district wide systems
- Includes charger, belt clip, rechargeable Li-Ion battery
- Also available in VHF, call for information

4.5"H, 10.3 oz.

RDU4100	*19082	\$371.50 ea.
RDU4160d	*19083	\$386.00 ea.
4 Watt Li-Ion Battery	19086	\$103.00 ea.

C. CLS Two-Way Radios

- Small & lightweight
- Coverage up to 200,000 sq. ft.
- 56 Frequencies for secure conversations
- CLS1110 1 channel, CLS1410 4 channels to separate different groups
- Display shows battery life and channel
- Includes charger, swivel holster, rechargeable Li-Ion battery

4.1"H 5 oz.

CLS1110	19047	\$280.00 ea.
CLS1410	19046	\$266.00 ea.
Li-Ion Battery	19044	\$46.55 ea.
6 Unit Charger	19087	\$233.00 ea.

Accessories

These accessories are compatible with the following radios: 19047, 19046, 55714, 19081, 19082, 19083, 19047, 19046.

Motorola Surveillance Earpiece	50160	\$77.05 ea.
Motorola Swivel Style Ear Piece	50163	\$47.65 ea.
Durable Remote Speaker Mic	50173	\$9.79 ea.

D. TalkAbout Recreational Two-Way Radios

Recreational FRS/GMRS models have 22 channels. Designed for family activities like camping, shopping, amusement parks. Not durable, not designed for everyday school use. Warranty void for school use. FCC required for most channels. Includes two walkies, two belt clips, dual charger, two NiMH rechargeable batteries.

MH230R	59984	\$62.85 pr.
Replacement Battery	19005	\$39.70 pr.

*** We can program the RDU4100 & RDU4160d radios to work with your existing radios for FREE!**

Emergency Blankets & Tools



Mylar® Blanket

Developed for use by astronauts, this Mylar® solar blanket retains 90% body heat and can be used as ground cover or a shield from elements. Perfect size for first aid kits! Conveniently folds to 3" x 4½" for easy storage.

84" x 52".....48025 \$3.88 ea.



Fire Blanket

Blanket is made of woven Fiberglas® and is stored in a highly visible, red vinyl packet that opens at the flick of a finger. Directions printed on wall-hanging packet.

72" x 48"23003 \$74.95 ea.

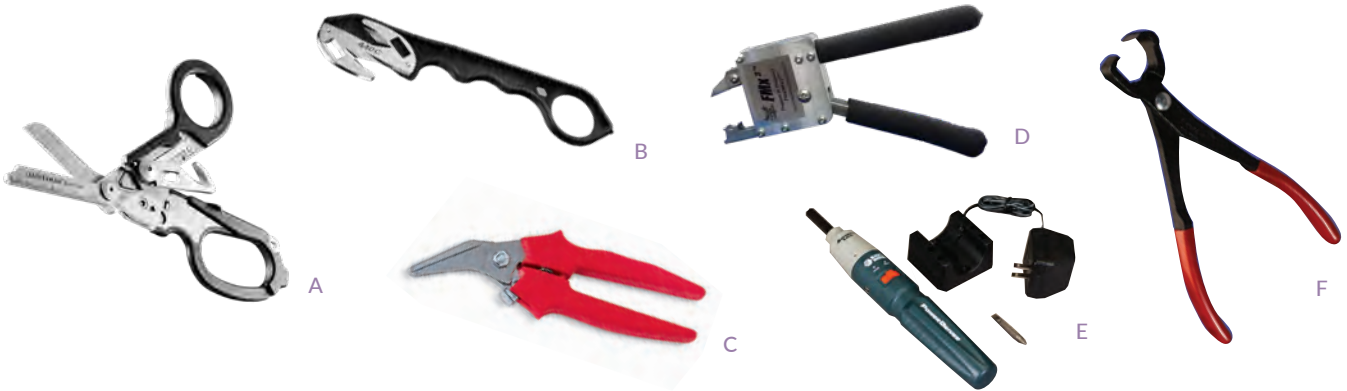

A. Raptor Medical Shears Leatherman

The fold-up medical shears from Leatherman are constructed of high-quality stainless steel. The necessary tools for sports medicine professionals are combined within to allow for quick and easy use. The Raptor folds up easily with built-in clip for convenient storage and access.

Closed Length: 5" (12.7 cm), Weight: 5.8 oz. (164 g),
Shear Length: 1.9" (4.8 cm)

..... 1002858 \$80.95 ea.

B. Z-Rex Cutting Tool Leatherman

Ergo-grip designed handle and V-notch cutting blade provide for better control and comfort than standard tape cutters. This tool was originally designed as an EMS rescue tool but is perfectly suited for a durable, long lasting, effective tape cutter. The V-notch cutting blade can be flipped for a fresh edge and can be re-sharpened or replaced. Made of premium stainless steel, it can safely and easily cut through multiple layers of tape, shoe laces, belts, and clothing. The handle is made of powder coated, lightweight, durable, aluminum.

..... 1002857 \$28.99 ea.

C. Super Snips

These stainless steel cutters zip through tape, thermoplastic, felt, or just about anything in your training room or clinic. Designed with a plastic grip handle, you get more leverage and smoother, faster cutting.

.....36020 \$32.00 ea.

D. FMx3™ FMxtractor

- FMxtractor Option Technology™
- Ratchet gear for 2 or 4 stage cutting reduces need for big hands and grip strength
- Enhanced internal gearing for improved cutting performance
- More robust, low-friction Cleaver Blade standard
- Quick-release and quarter-turn end-effectors
- Linear cutting ratchet reduces remnants
- Enhanced buttress provides flexible tool application
- Critical Care Pack™, including: AED and BLS airway management supplies
- FREE instructional webinar training offers CEUs

.....91272 \$514.99 ea.

E. Black & Decker® Power Driver

A cordless screwdriver. Includes battery, charger, and bit (two sided, Phillips and, slotted). Forward/reverse.

..... 90332 \$85.55 ea.

F. Trainer's Angel

Developed to aid safe access to a football player's airway. In an emergency, the "Angel" can cut the face mask side attachments, allowing the mask to be easily hinged open. A must for physicians, coaches, and trainers who require football emergency equipment.

.....90124 \$82.99 ea.

Athletic Training Kits & Bags



NEW! Mueller Medi-Kit Bags 250-251

Fanny Packs	250
Shoulder Bags & Backpacks.....	251
Cramer High Performance Gear AT Kits	252
5.11 Tactical Bags	253
Traditional Bags	255-256

Wheeled Bags	257-258
Kit Organizers & Crutch Bags	259
First Aid, Hard Kits, & Weather Proof Bags.....	260
Travel Cases	261-262

Fanny Packs



- All MedPac fanny packs are crafted of rugged, water-resistant, ballistic nylon
- Double-adjustable, self-centering web belt
- Side instrument pockets have hook-and-loop straps to secure instruments
- Convenient side pouch with Velcro® closure keeps tape or gloves readily accessible

A. Cramer® AT Fanny Packs

Each Cramer® Fanny Pack has a roomy main compartment with mesh pockets and bottle loops, front-mounted pockets for ready access to emergency supplies, a belt that expands to 58" and a back zippered pocket. Deluxe pack features quick access pockets, a tape pocket and a detachable pouch. Supplies not included.

AT 166 Fanny Pack		
11½"L x 5½"W x 2½"H40034	\$39.99 ea.
AT 273 Deluxe Fanny Pack		
13½"L x 7"W x 4"H40052	\$58.99 ea.

B. Cramer® Rigidlite Tactical

- All new, uniquely designed pack created for quick, easy access that stays out of the way while still close at hand
- Can be worn on right or left leg
- Specially designed cell phone/electronics pouch with protective rigidlite shell fits and protects all smartphones on the market today
- Protective and easy to organize semi rigid, thermoformed material with wide comfort straps
- Main compartment sized to carry prewrap, tape, bandages, tape, etc
- Main compartment 6"W x 9"H x 4"D

.....	40266	\$124.99 ea.
-------	-------	--------------

NEW!



Mueller® Medi Kit First In

The Mueller-Meret Meret Medi Kit First-In is based upon the highly successful Meret First-In Pro. Functions as a sling bag and a waist pack.

- Wipes clean; waterproof
- Fully cushioned sidewalls
- Double stitched stress points; taped reinforced seams
- One exterior end panel is entirely Velcro® loop, for attaching aftermarket accessories
- One exterior end panel has four MOLLE (Modular Lightweight Loadbearing Equipment) loops for aftermarket add-ons
- Meret M4L Lifetime Warranty

13"L x 5.5"W x 7.5"D, 1 lb. 12 oz

Black 1034425	\$112.99 kit
Hi-Viz Yellow 1034426	\$112.99 kit
Red 1034427	\$112.99 kit

A. MedPac Gluteus Minimius

Main compartment accommodates tapes, wraps, pocket mask and other essentials. A front tri-pocket organizer stores protective gloves, personal items and more.

4¾"W x 6¾"H x 3½"D, Black40097	\$69.99 ea.
---------------------------	------------	-------------

B. MedPac Gluteus Medius

Perfect for wraps, tape, bandages and a pocket mask. Pockets line the interior; belt pockets hold gloves, personal items.

8½"W x 6¼"H x 4"D, Black40096	\$79.99 ea.
--------------------------	------------	-------------

C. MedPac Gluteus Maximus

Adjustable, padded divider allows you to customize the roomy interior. Interior pockets and zippered side pockets provide additional storage. Gusseted front pouch has multiple instrument pockets, mesh pockets and elastic loops for easy reach.

11½"W x 6¼"H x 5"D, Black40095	\$94.99 ea.
---------------------------	------------	-------------



COMPARE & SAVE!

SH School Health Brand Fanny Packs

600 Denier Polyester (Comparable to Canvas) Waterproofing PVC Treatment.

13"W x 7"H x 3"D, Navy40154	\$11.30 ea.
------------------------	------------	-------------



JanSport® Fanny Pack

Zippered main compartment and front pocket. Adjustable waist belt with quick-release buckle. All JanSport® packs carry a lifetime warranty.

13"L x 6"W x 4"H, Black42039	\$25.50 ea.
-------------------------	------------	-------------

Shoulder Bags & Backpacks



Cramer® Rigidlite Razor

- Slim backpack design yet perfect for those who only want to carry a limited amount of supplies
- Protective and easy to organize
- Designed for transport and protection of notebook sized electronic device along with a small stock of athletic training supplies
- Clear plastic organizer pouches and medical bottle elastic loops double as electronics peripheral organizers ie. chargers and power cords
- The rear is your mobile office, perfect for a laptop and paperwork along with areas for storage of chargers or power cords. This section also functions quite well for AT supplies. The laptop pouch also holds the Cramer medical organizer

11" H x 5.5" L x 16" D *40264 \$279.99 ea.



NEW!

Mueller® Medi Kit V.E.R.S.A.

V.E.R.S.A. = Versatile Emergency Response System Assist

- 1680/1200 ICT (Infection Control Tarpaulin) body
- Double stitched stress points; taped reinforced seams
- Two TS2 Ready™ hideaway zippers for attaching one or two Medi Kit Modules
- A third Medi Kit Module may be attached via the anterior MOLLE system
- Fully concealable mountaineering style backpack system
- Laser cut MOLLE panels on three sides
- Heavy duty box-stitched grab/carry handle
- Overlapping interior panel secures and protects contents
- Ultra-Duty bottom skids
- Main compartment air dry capability
- Meret M4L Lifetime Warranty

13"W x 17"H x 8.5"D, 7 lbs.

Black 1034428 \$299.99 ea.

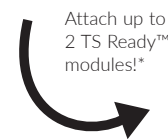

Attach up to 2 TS Ready™ modules!*



Cramer® Messenger Pack

Easy, quick access to your gear. Just sling the pack around front whenever you want to remove or stow contents. Inside zippered mesh pockets. Front strap for cell phone storage. Secures with a waist strap and a single shoulder strap.

.....40119 \$48.90 ea.

Cramer® Sling Pack Elite

Full zip compartments allow for easy unobstructed access to both main pockets. Exterior mesh pocket for quick access. Integrated cell phone holster also holds scissors for easy access. Contents not included.

13"L x 9"W x 10½"H
.....40157 \$149.99 ea.

Mueller® Hero™ Unsung Hero Medical Bag/Backpack

Customizable kit / backpack with interchangeable accessories, this rugged lightweight nylon exterior with reflective piping for increased visibility in low light. Accessories are constructed of lightweight nylon and durable crack resistant TPU (down to -40°F). Full-open design lets you unzip bags completely for easy packing and unpacking of gear. Premium handles and YKK brand zippers, that are built to last.

Kit includes:

- (1) Unsung 10" x 15" x 5"
- (2) L1 divider 5 x 5
- (2) L1 divider 10 x 5
- (2) M2 mesh pocket 10 x 10
- (1) M1 clear folded pocket

..... 1005903 \$179.99 kit

Medi Kit™ Pro Sport Backpack

The perfect equipment management system for the athletic training professional who wants a mobile organized solution for their supplies with a lot of expansion options.

- Secures up to 16 rolls of 2" tape
- EZ-Grab embroidered carry handles
- Identification sleeve

12"L x 9½"W x 18½"H
.....*40252 \$309.99 ea.

Medi Kit™ Fill Pack Module

This module offers additional storage while securely attaching to any TS-Ready system via TS-Ready™ zipper tracks.

14"L x 11"W x 23"H
.....*40254 \$59.99 ea.

*Modules sold separately

Cramer® High Performance Gear AT Kits

NEW RANGE OF HIGH PERFORMANCE ATHLETIC TRAINING GEAR DESIGNED TO BE TOUGH AND MEET THE NEEDS OF TODAY'S MOST DEMANDING ATHLETIC TRAINERS.



Cramer High Performance Gear AT Kits

- **Maximum Durability:** Constructed with highly durable, water & weather resistant ballistic and ripstop nylon fabrics, reinforced stitching, pro-grade YKK® zippers, and strengthened bottom and side panels to maintain structural integrity
- **Purposeful Organization:** Multiple customizable storage compartments sized to fit most commonly carried AT items, including clear compartments for easy identification
- **Ultimate Convenience:** Quick access to the frequent use items, easy grab handles, oversized zipper pulls, and ergonomic design for comfort

AT Fanny Pack

- One hand quick access side compartments with magnetic closures
 - Integrated quick access scissor holders
 - Adjustable, extra-long strap for alternative use as a sling bag
 - Breathable mesh padding for comfort and improved air circulation
 - Integrated pocket for safe electronics and valuable item storage
 - Multiple internal pocket configurations for custom organization
- 13"L x 5.5"W x 7"H..... **1030409** \$119.99 ea.

Large AT Shoulder Kit

- New HPG™ Divider System provides highly customizable interior with rigid dividers and quick adjust U-pins
 - Removable color coded organizational pods integrated into lid for quick access
 - Quick access front pocket with integrated storage and organization
 - Integrated waterproof rainfly protects contents of kit
 - Off set shoulder strap for improved carry comfort and reduced slippage
 - Multiple grab points provide carrying options and increase mobility
 - Reinforced bottom with end to end railing for maximum durability and stability
 - Integrated pocket for safe electronics and valuable item storage
 - Multiple internal and external pocket configurations for custom organization
- 23"L x 15"W x 11"H..... **1030410** \$449.99 ea.

Medium AT Shoulder Kit

- New HPG™ Divider System provides highly customizable interior with rigid dividers and quick adjust U-pins
 - Removable color coded organizational pods integrated into lid for quick access
 - Quick access front pocket with integrated storage and organization
 - Integrated waterproof rainfly protects contents of kit
 - Off set shoulder strap for improved carry comfort and reduced slippage
 - Multiple grab points provide carrying options and increase mobility
 - Reinforced bottom with end to end railing for maximum durability and stability
 - Integrated pocket for safe electronics and valuable item storage
 - Multiple internal and external pocket configurations for custom organization
- 19"L x 14"W x 11"H..... **1030411** \$329.99 ea.

AT Backpack

- Removable organizational storage trays integrated into design
 - Protective, enclosed compartment for tablet storage
 - Large detachable thermal waterproof storage container
 - XL exterior pockets for water bottle storage
 - Integrated strapping system for massage roller storage
 - Integrated waterproof rainfly protects contents of backpack
 - Rear hanging strap (ideal for hanging on fences)
 - Wide shoulder straps and lumbar support with breathable mesh padding for comfort and improved air circulation
 - Reinforced structure that maintains form and stability at various load levels
 - Integrated pocket for safe electronics and valuable item storage
 - Multiple internal and external pocket configurations for custom organization
- 11.5 "L x 9"W x 22"H **1030412** \$374.99 ea.

FREE SHIPPING at SchoolHealth.com/SportsMed

Get FREE SHIPPING on your online order over \$100! Go to the back cover for Free Ship Online code. Can only be used once per customer. Expires 12-31-20.



- Integrates with other 5.11 bags, belts, packs, and accessories
- Fully adjustable padded strap
- 1050D weather resistant nylon
- Hook and loop nametape and flag patches
- High impact locking clips
- MOLLE/SlickStick compatible



A. 5.11 Tactical UCR Sling Pack

Designed to have easy access and organization to supplies. Featuring a drop- front opening with side retention lashes, haul handles, interior pockets with bungee retention, and a large front web patch panel, the UCR Slingpack keeps your gear organized and at hand.

..... 1006649 \$143.99 ea.

B. 5.11 Tactical Push Pack, Sling Bag

A messenger style bag that provides quick efficiency in any situation.

Features:

- Dual expanding side pockets
- 8.75" H x 7.75" L x 4" D main compartment
- 1.31" x 7.75" x 3" top pocket
- 7.75" x 4" x 1.5" left and right side pockets
- 395 cubic inch / 6 liter total capacity
- Removable strap padding

..... 1005328 \$78.99 ea.

C. 5.11 Tactical Moab 6 Sling Bag

A small sling pack with modular storage expandability that can act as a athletic training sling back for the field.

Features:

- Ambidextrous
- Tech pocket at the shoulder, secondary double zip pocket and hydration pocket
- Fleece lined sunglass pocket
- Main compartment: 10.5" H x 9" L x 5" D
- Front compartment: 9.5" H x 8" L x 2" D
- Tech pocket pass-through cord slots

..... 1005330 \$81.99 ea.

D. 5.11 Tactical 2-Banger Bag

A quick, convenient, and modular carryall for carrying athletic training supplies. It has plenty of compartments and dived pockets for tape, bandages, and specialty supplies.

9.5"L x 3"W x 7"H

..... 1005447 \$72.99 ea.

E. 5.11 Tactical Disposable Glove Pouch

Features:

- 4.5" H x 3" L x 1.75" D main compartment
- 24 cubic inch total capacity

..... 55906 \$30.99 ea.

F. 5.11 Tactical Med Kit

Features:

- Secure tourniquet storage
- Clearly marked with sewn-on medical cross

..... 1005329 \$39.99 ea.

G. 5.11 Tactical Med Pouch

Features:

- One-hand accessible
- Durable nylon construction

..... 1005331 \$39.99 ea.

H. 5.11 Tactical H2O Carrier

Features:

- High impact locking clip
 - Durable all-weather 1000D nylon
- 7½"H x 4½" Diameter

..... 1005334 \$33.99 ea.

I. 5.11 Tactical Bandage Pouch

Sized for GPS, Strobe, or similar handheld device.
3¾"W x 5"H x 1½" D

..... 1005333 \$27.99 ea.

J. 5.11 Tactical Radio Pouch

Fits any standard radio handset.

5"H, 3¾" W, 1½" D

..... 1005332 \$22.99 ea.

K. 5.11 Tactical MP5 Bungee Tool Carrier

Features:

- Water resistant back coating
- Stackable design for easy expansion

..... 1006664 \$22.99 ea.

L. 5.11 Tactical Instrument Accessory Patch

Keep your pen and flashlight in easy reach. Holds a pen, flashlight, and business cards.

..... 1006663 \$7.99 ea.

M. 5.11 Tactical BBS Flex Kit

Tough and dependable 500D nylon. Two 3" x 7" panels.

..... 1006665 \$18.99 ea.

N. 5.11 Tactical® 6.6 Pouch

6"W, 6"H, 3" D ... 1007421 \$28.99 ea.



NEW MUELLER® BY MERET™ NOW AVAILABLE

Mueller® has teamed up with one of the industry leaders in Athletic Trainer kits and is honored to offer an expanded premium line of kits to meet your every need. Mueller® by MERET™ is built for the professional - professionals that depend on rapidly and proficiently deploying athletic training supplies during crucial moments. Mueller® by Meret™ products will function for a lifetime under the MERET for Life (M4L) Warranty Policy.



1680/1200 ICT
Infection Control Tarapaulin

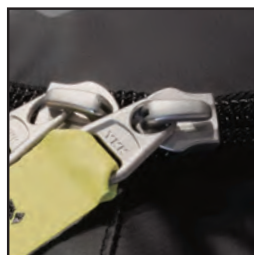

Oversized #10 YKK Super
Tough zippers w/ alloy pulls



Solid alloy hardware



2 Needle taped seams



SLIDERS™ System for
unlimited configurability



MOLLE compatibility

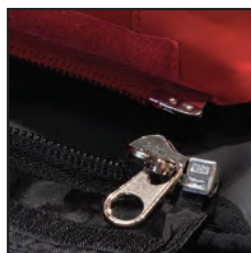

TS2Ready™ for attaching
add-on modules



Mueller® Medi Kit Omni

Features:

- Constructed from durable, wipe-clean tarpaulin that is water and stain resistant
- Adjustable padded yoke backpack strap harness system easily distributes weight for comfort with adjustable sternum and waist belt
- TPE lined back and bottom resists water and wear
- Durable bottom skid runners
- Customized internal main compartment
- LIFETIME WARRANTY
- All main compartments open completely for full view of contents
- All compartments have air dry capability
- Contents are not included

15"L x 22"W x 9.5"H,

Black **1002253** \$399.99 ea.



Mueller® Hero Response Athletic Training Kit and Medical Bag

Includes:

- (1) Response athletic training kit and medical bag
- (1) M2 Clear Pocket 10 x 10

Stocked Kit Includes:

- | | |
|------------------------------------|----------------------------------------|
| (10) 3" x 3" gauze pads | (1) Elastic bandage roll |
| (4) 4" x 4" gauze pads | (1) Glove canister |
| (6) M Strips® X-large | (3) Pair exam gloves |
| (12) M Strips® Regular | (1) MuellerKold® instant cold pack |
| (10) Nasal plugs | (1) M Wrap® roll |
| (1) 3 oz lubricating ointment | (1) 1.5" M Tape® roll |
| (1) M Cutter™ | (1) Tape Tote™ |
| (1) 2 oz germa spray | (1) 4 oz Coolant cold spray |
| (1) 3 oz Medi Stat™ spray | (1) Wonder Wrap™ (3" elastic wrap) |
| (1) 4 oz Tuffner® Pre-Tape spray | (1) 4 oz Tape & Tuffner® remover spray |
| (1) 2.75 oz abrasion ointment | (1) 3" gauze roll |
| (10) StaphASeptic™ 1/16 oz packets | |

15" x 10" x 10"

Bag (Empty) **1005908** \$174.99 ea.

Bag with Supplies Included **1005924** \$229.99 kit



Mueller® Hero Perfect Hero Medical Bag

Kit includes:

- (2) L2 Divider 10" x 10" (2) M2 Mesh Pocket 10" x 10"
- (2) L2 Divider 5" x 10" (4) Tie Down Strap

20" x 10" x 10" **1005904** \$239.99 kit

Professional Bags by Watts

Interior contains many adjustable Velcro® compartments to allow for maximum versatility. Two large side pockets and elastic loops for airway holders and scissors provide additional storage space. Navy with black straps.

A. 13"W x 8"H x 9"D **40024** \$149.50 ea.

B. 20" W x 9"H x 13" D **40016** \$183.50 ea.



A



B

Traditional Bags



A



CUSTOMIZE WITH YOUR LOGO!

B



C



D



School Health Brand Athletic Trainer Bags by Watts

All School Health Athletic Trainer Bags feature foam padding on all sides; durable, lightweight plastic throughout sidewalls for rigidity and protection; professional grade zippers; padded carrying handle; and 1680 denier ballistic material, which outlasts next best fabrics 3 to 1.

Free embroidery! You may choose the color and font to go on the side and top panels of the bag. A set-up fee is required if you wish to have a custom logo included.

A. Small Bag

- 5 outer pockets and 6 interior pockets
 - 2 interior mesh pockets
 - 2 removable and adjustable interior dividers
- 21" L x 8½" W x 10" H

Black	40233	\$344.99 ea.
Red.	40234	\$344.99 ea.
Navy	40235	\$344.99 ea.
Green. . . .	40236	\$344.99 ea.

B. Medium Bag

- 5 outer pockets and 12 interior pockets
 - 4 interior mesh pockets
 - 8 interior clear plastic pockets
 - 7 removable and adjustable interior dividers
- 25" L x 13" W x 12½" H

Black	40237	\$429.99 ea.
Red.	40238	\$429.99 ea.
Navy	40239	\$429.99 ea.
Green. . . .	40241	\$429.99 ea.

C. Large Bag

- 5 outer pockets and 12 interior pockets
 - 4 interior mesh pockets
 - 8 interior clear plastic pockets
 - 7 removable and adjustable interior dividers
- 28½" L x 13" W x 12½" H

Black	40242	\$569.99 ea.
Red.	40243	\$569.99 ea.
Navy	40244	\$569.99 ea.
Green. . . .	40245	\$569.99 ea.

D. Large Bag with Wheels

28½" L x 13" W x 12½" H	
Black	40246 \$654.99 ea.
Red.	40247 \$654.99 ea.
Navy	40248 \$654.99 ea.
Green	40249 \$654.99 ea.



Cramer® TUF-TEK™ AT Kits

- Single pull, zipper design allows for a gradual turn around corners which increases zipper life and offers easier access in to the bag
 - A large cell phone pocket for today's large cellular devices
- | | | |
|-----------------------------------------|--------------|--------------|
| 12"L x 10.5"W x 8"H, Junior | 40255 | \$229.99 ea. |
| 15"L x 14"W x 8.5"H, Pro | 40257 | \$259.99 ea. |
| 17.75"L x 15"W x 10.5"H, Super. | 40259 | \$369.99 ea. |



MedPac Bags

- Dividers separate larger supplies from other equipment
 - Full-length, zippered compartments on the front, back and both sides
 - Front pouch has instrument pockets and loops
 - Full-access lid stays upright for visibility and easy access
 - Reflective tape visible on all sides
- | | |
|--------------------------------------|---------------------------|
| MedPac 4800 | |
| 25"W x 16"D x 11½"H, Black | 40111 \$449.99 ea. |
| MedPac 3800 | |
| 22"W x 15"D x 11"H, Black | 40113 \$404.99 ea. |



5.11 Tactical SOMS™ 3.0 Rolling Duffel Bag

This rolling duffel bag offers a broad range of customizable storage options and travel-friendly features that keep you organized in any setting.

Features:

- Extendable roll handle
- Moisture and weather resistant ultra-durable 1600D nylon
- Self-retracting grab handles at ends
- Heavy duty oversized wheels and skids
- Easy-access document pocket
- MOLLE/5.11 SlickStick® interior webbing
- Adjustable internal dividers

Dimensions:

- 32" H x 14.5" L x 14" D main compartment
- 13.5" x 11" x 2" right side pocket (x2)
- 27" x 11" x 2" left side pocket
- 12.75" x 9.75" flat document pocket

Black	1008559	\$349.99 ea.
Gray w/ Black	1008560	\$369.99 ea.



Bushwalker® Superskate Medical Bag

Double-top lid with instrument sleeves, box pockets on front, back and one side. Full-length divider with four small dividers. Easy rolling skate wheel system with built-in telescoping handle.

26" L x 18" W x 15" H	*40115	\$699.99 ea.
-----------------------------	---------------	--------------



Cramer® TUF-TEK™ Traveler AT Kits

- Black nickel finish handle system with ultra durable ,oval shaped support pipes.
- Wide set anti-tip wheels keep the bag from rolling over on its side. They also double as protectors for the lower corners which are the highest wear areas on wheeled kits.

Traveler Jr, 22"L x 7.5"W x 12.75"H	40261	\$519.99 ea.
Traveler, 27"L x 12"W x 16"H	40262	\$747.99 ea.



*Modules sold separately

M.U.L.E Pro Sport Response Bag

The bag for the athletic training professional who wants all the options. It's a field tested roller bag and a harness style backpack that can be carried briefcase style, carry up to 4 TS Ready™ modules, pack more than 150 rolls of 2" tape, be completely internally customized, and is backed by the MERET Lifetime Warranty!

14"L x 9½" W x 26½" H	40250	\$429.99 ea.
-----------------------------	--------------	--------------

Xtra™ Fill Pack Pro Sport Module

This module offers additional storage while securely attaching to any TS-Ready system via TS-Ready™ zipper tracks.

14"L x 11" W x 23"H	40254	\$59.99 ea.
---------------------------	--------------	-------------

FREE SHIPPING at SchoolHealth.com/SportsMed

Get FREE SHIPPING on your online order over \$100! Go to the back cover for Free Ship Online code. Can only be used once per customer. Expires 12-31-20.

*Direct-ship item. Please allow additional time to receive.

Wheeled Bags



Mueller® Hero Epic Hero Roller Medical Bag

Customizable kit / backpack with interchangeable accessories, this rugged lightweight nylon exterior with reflective piping for increased visibility in low light. Accessories are constructed of lightweight nylon and durable crack resistant TPU (down to -40°F). Full-open design lets you unzip bags completely for easy packing and unpacking of gear. Premium handles and YKK brand zippers, that are built to last.

Kit includes:

- (1) Epic 25" x 15" x 10"
- (2) L2 Divider 10" x 10"
- (2) L2 Divider 15" x 10"

- (1) M2 Mesh Pocket 10" x 10"
- (2) M2 Clear Pocket 10" x 10" (2 EA.)
- (4) Tie Down Strap

..... **1005906** \$409.99 ea.



Mueller® Hero Titan Hero Roller Medical Bag

Customizable kit with interchangeable accessories, this rugged lightweight nylon exterior with reflective piping for increased visibility in low light. Accessories are constructed of lightweight nylon and durable crack resistant TPU (down to -40°F). Full-open design lets you unzip bags completely for easy packing and unpacking of gear. Premium handles and YKK brand zippers, that are built to last.

Kit includes:

- (1) Titan 30" x 15" x 10"
- (2) L2 Divider 10" x 10"
- (2) L2 Divider 15" x 10"

- (1) M2 Mesh Pocket 10" x 10"
- (2) M2 Clear Pocket 10" x 10"
- (4) Tie Down Strap

..... **1005905** \$444.99 ea.



Mueller Hero Accessories

Purchase these accessories to customize any Mueller Hero Bag.

A. L1-5 Divider Kit

Kit includes:

- (2) L1 Divider 5" x 5"
- (2) L1 Divider 10" x 5"
- **1005914** \$22.99 ea.

B. L2-10 Divider Kit A

Kit includes:

- (2) L2 Divider 10" x 10"
- (2) L2 Divider 15" x 10"
- **1005916** \$44.99 ea.

C. L2-10 Divider Kit B

Kit includes:

- (2) L2 Divider 10" x 10"
- (2) L2 Divider 5" x 10"
- **1005915** \$32.99 ea.

D. Tie Down Strap Kit

Kit includes:

- (4) Tie Down Strap
- **1005901** \$17.99 ea.

E. M1-5 Zipper Pocket Kit B

Kit includes:

- (2) M1 zipper clear Pocket 10" x 5"
- **1005913** \$17.99 ea.

F. M1-5 Clear Folded Pocket Kit

Kit includes:

- (2) M1 Clear Folded Pocket 10" x 5"
- **1005911** \$29.99 ea.

G. M1-10 Cartridge Kit

Kit includes:

- (2) M1 Cartridge 10" x 5"
- **1005917** \$32.99 ea.

H. Mueller® Hero™ M2 Cartridge

Kit includes:

- (2) Mueller Hero™ M2 Cartridge 10" x 10"
- **1005922** \$44.99 ea.

I. M2-10 Mesh Pocket

Kit includes:

- (2) M2 Mesh Pocket 10" x 10"
- **1005918** \$29.99 ea.

J. M2-10 Folded Clear Bandage Pocket

Kit includes:

- (2) M2 Clear Folded Pocket 10" x 10"
- **1005910** \$34.99 ea.

K. M2-10 Clear Pocket Kit

Kit includes:

- (2) M2 Clear Pocket 10" x 10"
- **1005919** \$29.99 ea.

NEW!



A



C



E



B



D



F

A. Medi Kit X2 Fill Pack Module, Black

Mueller-Meret Medi Kit Fill Pack Modules are offered in two sizes, as a unique approach to expanding the versatility and capacity of the Mueller-Meret VERSA, Omni and M.U.L.E. kits.

11" L x 7" H x 4.75" D, 75 cubic inch capacity.

Weight: 10 oz. **1034422** \$119.99 ea.

B. Bushwalker Large Bandage Kit

A great way to arrange bandages and unit dose meds for quick ID and access. Fold over design with Velcro® closure, clear vinyl sleeves and mesh sleeves.

Overall (flat): 18"L x 16" W x ¼"H, Closed: 9"L x 16"W x ½"H

..... **40135** \$54.99 ea.

C. Bushwalker Small Bandage Kit

Carries bandages from ¾" to 4" x 4", 4 and 8 half width secured interior sleeves. Fold over design with snap strap and Velcro® back to attach inside of our Med Bag lids.

15"L x 5"W x ¼"H, Closed: 7.5"L x 5"W x ½"H

..... **40136** \$34.99 ea.

D. Cramer® Rigidlite Pods

- Protective and easy to organize, these semi-rigid accessories have multiple uses
- Modules have elastic netted pockets on both sides to keep gear in place and still easy to locate
- Center divider has zippered clear plastic pockets perfect for meds, bandages, and other small items

Large, 7"L x 3¼"W x 10½"H **40218** \$64.99 ea.

E. Cramer® Elite Organizer Kit

Tri-fold design allows for maximum storage space in this small design, and multiple zippered, mesh pockets promote easy organization of medications, bandages and other small items. Clear, rubberized pocket makes larger items like scissors, applicators and gloves easily accessible. Bag comes empty.

12"L x 6"W x 1½"H **40172** \$42.99 ea.

F. Cramer® Rigidlite Tape Carrier

- Protective and easy to organize – keeps tape just like it was out of the box
- Holds two layers of six rolls of tape held in by molded pegs
- Includes semi-rigid removable divider

9½"L x 7"W x 3½"H **40219** \$51.99 ea.



A



B



C

A. Mueller® Tape Roll Holder

Keep tape at your fingertips with this convenient tape roll holder. Inner divider disc can be moved to create different sized compartments for a variety of tapes and prewrap. Fasten securely with hook and loop closure.

..... **28491** \$9.99 ea.

B. Crutch Bag

Designed to hold two pairs of crutches, braces, splints, and basic supplies.

54"L x 7½"W x 15"H **40114** \$399.99 ea.

C. CrutchPac Plus by MedPac

Carries two sets of crutches in the main compartment with hook and loop straps to secure crutches during travel. Outside pockets (two on back, four on front) store immobilizers, braces, cervical collars and more. One front pocket is further organized with zippered pockets and elastic loops. Heavy-duty carrying handles and shoulder strap included.

55"W x 13"D x 9"H

Black **45027** \$349.99 ea.

First Aid, Hard Kits, & Weather Proof Bags



Coach's Team First-Aid Kit

Best used for a team's first aid demands.

This kit includes:

- (2) Instant Cold Packs
- (1) Sam Finger Splint
- (5) Butterfly Bandages
- (3) After Bites®
- (6) Tongue Depressors
- (1) Tuf-Skin® Taping Base
- (3) Knuckle Bandages
- (1) Tape Underwrap
- (3) Fingertip Bandages
- (1) Pr. Scissors
- (10) Gauze Pads, 3" x 3"
- (6) Alcohol Prep Pads
- (1) Elastic Wrap, 3"
- (5) Bandages, 2" x 4½"
- (1) Roll Tape
- (1) Triangle Bandage
- (1) Skin Lube® Lubricant
- (12) Antiseptic Towelettes
- (5) Acetaminophen
- (5) Antibiotic Creams
- (10) Bandages, ¾" x 3"
- (1) Sports Injury Care Handbook

.....42077 \$98.99 kit

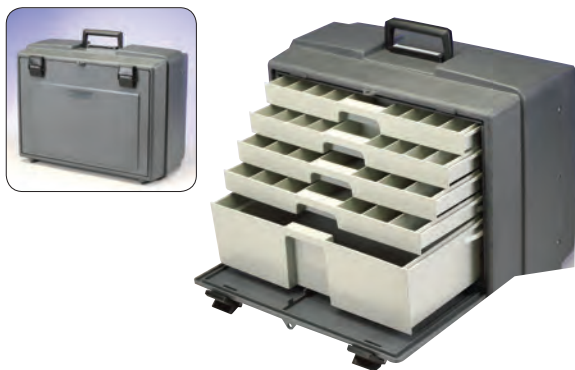

Flambeau Medical Kit

Large, professional unit organizes, stores and protects medical supplies and equipment. Includes interchangeable drawers with adjustable compartment sizes, padlock tab, two positive action latches, brass hinge and brass latch pins. Components are molded in high-impact resins. Drawer cabinet features a self-storing front door panel providing all-weather protection for all the drawers. Unique design allows drawer access when front door panel is down.

19"W x 15"H x 10¾"D

Gray.....24312 \$171.50 kit

FREE SHIPPING at SchoolHealth.com/SportsMed

Get FREE SHIPPING on your online order over \$100! Go to the back cover for Free Ship Online code. Can only be used once per customer. Expires 12-31-20.



Iron Duck® Trauma Bags

The industry standard for first responders. Flap lid and Delrin® buckles allow quick access. Tacked elastic tool holders, zippered lid pocket, padded main compartment, two wing pockets and divided full front pouch. 1000 denier nylon. Lifetime guarantee.

17"W x 7"H x 9"D

Orange40054 \$105.50 ea.



FOOBAG Med Kit Rain Bag

The FOOBAG was designed by an Athletic Trainer FOR Athletic Trainers to help keep their medical supplies and equipment dry. With its 2" heavy duty Velcro on three sides, the FOOBAG remains functional, allowing easy access to supplies. It not only protects from the rain, but also from dirt, dust and the sun.

Size	Length	Item #	Price
Small	22" or less	40229	\$61.99 ea.
Medium	23" to 28"	40230	\$69.99 ea.
Large	29" to 34"	40231	\$69.99 ea.
X-Large	35" to 40"	1006725	\$159.99 ea.

Plano Guarantee: Plano molded plastic kits are so tough and durable, each one carries a lifetime guarantee. If the kit ever fails, return it directly to Plano for repair or replacement.



A. Wilson® SplitTop Loaded Athletic Trainer's Case

A favorite among college and pro Athletic Trainers throughout the country, the SplitTop's unique flip open lids keep equipment organized and accessible. These cases come standard with dual trays, 16 dowel tape assembly and adjustable dividers. These heavy duty athletic equipment cases come standard with phenolic casters. These casters are great for hard surfaces and each have a 700 pound rating. For easy rolling on fields—upgrade to the Turf Tires.

Features:

- Outside Dimensions: 28" x 24" x 26"
- Inside Dimensions (Body): 26" x 22" x 12"
- Inside Dimensions (Lids): 26" x 9.75" x 7" (each)
- Recessed Key Lock
- Two Lockable Inner Doors
- 16 Dowel Tape Assembly -holds up to 64 1.5" tape rolls
- Adjustable Divider Assembly -includes 6 dividers
- Set of 2 Dual Trays: (20" x 11 x 4" each)
- Four Heavy Duty Casters: 1.5" x 3.5" Diameter
- Case Weight: 63 Lbs. (approx.)
- Case Material: Wilson LT Panel

SplitTop Loaded Athletic Trainer's Case . . . *1005623 \$1,599.99 ea.

Wilson Case 6" Turf Tire Upgrade Set with brakes (Must be ordered with SplitTop Case)

.....*40201 \$149.99 ea.

Wilson Case 6" Turf Tire Upgrade Set without brakes (Must be ordered with SplitTop Case).

.....*40200 \$109.99 ea.

B. SplitTop Loaded XL Athletic Trainer's Case

A favorite among college and pro Athletic Trainers throughout the country, the SplitTop's unique flip open lids keeps equipment organized and accessible. These cases come standard with dual trays, 16 dowel tape assembly and adjustable dividers. The SplitTop XL is deeper and comes with 6" turf tires compared to standard casters that are on the SplitTop.

Features:

- Outside Dimensions: 28" X 24" X 35.75"
- Inside Dimensions (Body): 26" x 22" x 18 3/4"
- Inside Dimensions (Lids): 26" x 9.75" x 7" (each)
- Recessed Key Lock
- Two Lockable Inner Doors
- 16 Dowel Tape Assembly -holds up to 64 1.5" tape rolls
- Adjustable Divider Assembly -includes 6 dividers
- Set of 2 Dual Trays: (20" x 11 x 4" each)
- Turf Tires: (4) 6"
- Case Weight: 77 Lbs. (approx.)
- Case Material: Wilson LT Panel

.....*1005624 \$1,759.99 ea.

C. Wilson® Case MobileMed Athletic Trainer's Shipping Case

- Outside dimensions: 33.48"L x 19.23"W x 30"H with (4) heavy duty red poly casters
- Tilt-bins in lid: (4) 9"L x 3"W x 4"H
- (4) Drawers on glides:
 - With lid and divided into (4) 6.63"L x 6.63"W x 4.26"H areas: 14.25"L x 14.25"W x 4.26"H
 - Carpet lined: 14.25"L x 14.25"W x 11.01"H
 - Carpet lined: 14.25"L x 14.25"W x 7.76"H
 - With 16 tape dowels (holds up to 80 1.5" rolls): 14.25"L x 14.25"W x 7.76"H
- Area in lid with (3) adjustable shelves (has a removable door to keep items in place when the lid is closed): 9"L x 4.25"W x 17"H
- Table top area for dispensing meds and treating athletes: 32" x 15.5"
- Recessed key lock
- Wilson LT Panel construction for high strength and light weight
- Color: Black
- 130 lbs. (approx.)

.....*40198 \$2,799.99 ea.

* Direct-ship item. Please allow additional time to receive.

Travel Cases



A



B



C



D

A. Wilson® Case SportLocker I & II Equipment Cases

- With two handy sizes to choose from, the SportLocker I & II are designed to hold a lot of gear – yet still be small enough to ship by UPS
- These heavy duty cases come standard with 3.5" casters (250 pound rating) – great for hard surfaces
- For easy rolling on fields, upgrade to optional Turf Tires
- Many Equipment Managers also add the optional full length trays to keep smaller items separate
- Color: Black
- Wilson LT Panel construction for high strength and light weight

Specifications for SportLocker I

- Outside Dimensions: 32"L x 22"W x 27"H
- Inside Dimensions: 30"L x 20"W x 20"H
- Usable space (before tray): 30"L x 20"W x 15.5"H
- Usable space under optional tray: 30"L x 20"W x 12.5"H
- Full Length Tray (optional): 28"L x 18"W x 4"H
- 47 lbs. (approx.)

.....*40207 \$849.99 ea.

Optional Full Length Tray

.....*40208 \$99.99 ea.

Specifications for SportLocker II

- Outside Dimensions: 38"L x 26"W x 31"H
- Inside Dimensions: 36"L x 24"W x 24"H
- Usable space (before tray): 36"L x 24"W x 13.5"H
- Usable space under optional tray: 36"L x 24"W x 16.5"H
- Full Length Tray (optional): 34"L x 22"W x 4"H
- 62 lbs. (approx.)

.....*40209 \$1,111.99 ea.

Optional Full Length Tray

.....*40210 \$189.99 ea.

Optional Turf Tires for SportLockers I & II

- 6" Turf Tire Upgrade – without brakes (must be ordered with case) . . *40200 \$109.99 set
- 6" Turf Tire Upgrade – with brakes (must be ordered with case) . . *40201 \$149.99 set
- 8" Turf Tire Upgrade – without brakes (must be ordered with case) . . *40211 \$149.99 set
- 8" Turf Tire Upgrade – with brakes (must be ordered with case) . . *40212 \$189.99 set

B. Wilson® Case SportMate Athletic Trainer's Case

- Compact – fits in the truck or backseat
- Features a fold-down door, adjustable shelves, large trays with adjustable dividers and ProLatch organizer trays
- All of the trays are removable
- Outside Dimensions: 19"L x 19"W x 29"H
- Shelves in Lid: (3) 3.5" x 13.75" (2 are adjustable)
- (4) Removable ProLatch Organizer Trays: 15"L x 11.25"W x 2.25"H
- (2) Removable Plastic Trays with Adjustable Dividers: 16"L x 11"W x 6"H
- Pull-Out Handle
- (2) recessed casters
- Recessed Key Lock
- Color: Black
- Wilson LT Panel construction for high strength and light weight
- 56 lbs. (approx.)

.....*40213 \$1,239.99 ea.

C. Wilson® Case UltiMate Athletic Trainer's Case

- Features a fold-down door, adjustable shelves, tape spindles, large trays with adjustable dividers and ProLatch organizer trays – keeps all of your supplies in place and at your finger tips
- All of the trays are removable – allowing you to take your supplies anywhere
- Outside Dimensions: 19" x 19" x 44"
- Swing-Out Tape Spindles (in lid): (2) Each holds up to 24 rolls of 1.5" tape
- Shelves in Lid: (2) Adjustable 4.5" x 16" each (1) Fixed 4.5" x 16"
- ProLatch Organizer Trays(removable): (4) 15" x 11.25" x 2.25" each
- Removable Plastic Trays with Adjustable Dividers:
 - (2) 16" x 11" x 6", 16" x 11" x 8" and 16" x 11" x 3"
- Pull-Out Handle
- (3) Edge Casters
- Recessed Key Lock
- Color: Black
- Wilson LT Panel construction for high strength and light weight
- 75 lbs. (approx.)

.....*40215 \$1,999.99 ea.

D. Wilson® Case TablePro-1 Athletic Trainer's Case

- Smartly designed case for a smooth transition from the training room to the road
- The TablePRO-1 can handle the largest athletes with ease and has ample room for supplies
- Features Table Pads and a Pull-Out Taping Station on each end
- Outside Dimensions (closed): 47.4"L x 32.9"W x 37.1"H (including tires)
- Outside Dimensions (open): 65.8"L x 23.6"W x 37.1"H
- (8) 6" Turf Tires – (5) swivel and (3) with brakes
- (3) Carpet-lined Drawers on Glides: 20.1"L x 20.8"W x 7.5"H
- (1) Removable Tray with Adjustable Dividers: 20"L x 15"W x 7.9"H
- (1) Removable Tray with Adjustable Dividers: 20"L x 15"W x 5.9"H
- (2) Removable Tray with Adjustable Dividers: 20"L x 15"W x 4.9"H
- (2) Slide-Out Taping Stations on Glides – each station includes:
 - (12) Tape Dowels – holds up to (84) 1.5" tape rolls
 - (4) Tilt Bins: 9" x 9" x 4"
 - Storage Area Behind Bins: 3.5" x 20" x 12.75"
- Color: Black
- 313 lbs. (approx.)

.....*40214 \$5,399.99 ea.

* Direct-ship item. Please allow additional time to receive.

Pharmacy & Instruments

Look for the **VALUE PRICED** products in this section. They are found in the colored boxes

VALUE PRICED

Prescription (Rx) Items	264	Screening Tests	276
Antacids & Gastrointestinal	265-266	Skin Care	277-283
Allergy, Cold & Flu	268-269	Medication Supplies & Syringes	284
Cold, Cough & Flu	270	Topical Analgesics & Muscle Care	285-286
Pain Relief	271-272	Instruments & Sterilization	287
Hydration & Hygiene	273	Tape Scissors & Cutters	288
Ophthalmics	274	Scissors & Forceps	289
Oral & Dental Care	275	Specialty Instruments	290

Prescription (Rx) Items*

EPINEPHRINE



A



B



C



D



E

A. EpiPen® Auto Syringe™*

Self-injection systems that can provide a rapid, convenient dose of epinephrine for individuals needing protection from potentially fatal allergic reactions.

EpiPen® Auto Syringe™ Dual Pack (Rx Item)*

0.15 mg. Junior.....*91329 Call for Pricing
 0.3 mg. Regular.....*91330 Call for Pricing

B. Lineage Therapeutics Epinephrine Auto-Injector®

Self-injection systems used to deliver an immediate measured dose of epinephrine in the case of anaphylaxis due to potentially fatal allergic reactions. Available in both Regular (>66 lbs.) and Junior (33-66 Lbs.)

Dual Pack epinephrine auto-injectors (Rx Item)*

0.15 mg Junior*91629 Call for Pricing
 0.3 mg Regular*91628 Call for Pricing

Please note: Epinephrine pens you receive have the best expiration date available at this time.

C. Generic EpiPen® Auto Syringe™

A self-injection system that can provide a dose of epinephrine for individuals needing protection from potentially fatal allergic reactions. It provides the same protection at a fraction of the price of name brands.

Generic EpiPen® Auto Syringe™ Dual Pack (Rx Item)*

0.3 mg. Reg*1007423 Call for Pricing
 0.15 mg. Jun*1007424 Call for Pricing

D. Adrenalin® Injection (epinephrine injection, USP) 1mg/mL Single-Dose Vial

Used to treat sudden/severe breathing problems, severe allergic reactions from food/drugs/other substances, and certain heat problems. This is an Rx item and requires administration by a licensed professional. (Rx Item)*

Adrenalin 1MG/ML25 SDV,*1008082 Call for Pricing

E. EpiPen® Trainer

The EpiPen® Trainer will help you and others prepare for allergic emergencies. It has the same mechanism as a regular auto-injector, without the needle or medication. Reusable.

..... 90313 \$9.31 ea.

EPINEPHRINE STORAGE

Mounts with velcro and holds up to six autoinjectors!



Allergy Emergency Kit - Hallway Case

The same forward-thinking concepts of the Original Allergy Emergency Kit in a more affordable format. This high-quality resin storage case uses Velcro to conveniently store up to six epinephrine auto-injectors and laminated instructions. It mounts to any wall with included Velcro fasteners, no drilling required. The case can be quickly grabbed from the wall and moved to the point of need. This case does not utilize a key or an alarm.

..... 1006092 \$69.00 ea.

Emergency Epinephrine Cabinet

16 Unit, 17" x 17" x 4"
 91618 \$392.50 ea.

Insulated Allergy Emergency Bag

This pack is intended to give coaches and athletic trainers quick access to Emergency Medical Supplies. Insulated to retain a safe temperature range longer – ideal for transporting Epinephrine and Benadryl in a case intended for indoor/outdoor use. Supplies not included.

..... 1006091 \$46.05 ea.

SafetySack Medication Pouch

Clear, nylon pouch designed to hold medication and features a child-resistant safety lock and re-closable slide zipper. Choose from two Emergency Action Plan cards that include: information on the child — picture, name and specific condition; list of symptoms to watch for and treatment; list of medications in SafetySack along with expiration dates; and list of emergency contacts.

EpiPen.....61702 \$13.90 ea.
 Blank.....61704 \$13.90 ea.

MISCELLANEOUS PRESCRIPTION (Rx) ITEMS*



*Albuterol Proair HFA

Albuterol is used to treat or prevent bronchospasm in people with reversible obstructive airway disease. Albuterol is also used to prevent exercise-induced bronchospasm. (Rx Item)*

8.5 gm., 90 mcg.*1031186 Call for Pricing

*Albuterol Inhalation Solution

Used in a nebulizer to prevent and treat wheezing, difficulty breathing and chest tightness caused by lung diseases such as asthma and chronic obstructive pulmonary disease (COPD; a group of diseases that affect the lungs and airways).

(Rx Item)*

3 mL., 25/box 90720 \$21.40 box

* All prescription (Rx) purchases Requires Rx authorization form See "Medical Authorization Form" in the Index section.
 Please note: Epinephrine pens you receive have the best expiration date and price available at the time of purchase. Call Customer Care at 866-323-5465 with any questions.



A



B



C



D



E



F



G



H



I



J



K

ANTACID

A. Zantac®

Used to treat and prevent ulcers in the stomach and intestines. 75 mg.

UNIT DOSE

100 /1's.....44435 \$80.95 box

B. Pepcid AC®

Prevents and relieves heartburn due to acid indigestion. For adults and children age 12 years and older.

Regular Strength Tablets

30's.....44179 \$18.00 box

Maximum Strength Tablets

8's.....44581 \$8.72 box

50's.....44583 \$27.40 box

C. Pepcid Complete Chewable Tablets

Quickly relieve heartburn associated with acid indigestion and sour stomach. Combine a fast-working antacid and a long-lasting acid reducer to help control acid all day and night.

Berry, 25/pkg.....44584 \$18.35 pkg.

D. Tums®

For the relief of: Heartburn, sour stomach, acid indigestion, upset stomach associated with these symptoms.

Extra Strength, Assorted Tropical Fruit

96's.....44204 \$10.05 ea.

E. Alka-Seltzer® Original with Aspirin

For use by adults and children 12 and up.

UNIT DOSE

Foil Pack, 72's.....44026 \$17.20 box

F. Medique® Medi-Seltzer

(Compare active ingredients to Alka-Seltzer) Effervescent pain reliever and antacid with specially buffered aspirin in tamper evident UNIT DOSE packets.

36 /2's.....44307 \$13.85 ea.

G. Medique® Alcalak Antacid Tablets

(Compare active ingredients to Tums) Mint flavor. For heartburn, sour stomach, acid indigestion and upset stomach.

UNIT DOSE

12 /2's.....44542 \$2.60 box

100 /2's.....44309 \$15.90 box

Ant-Acid Tablets

(Compare active ingredients to Tums)

Fruit,150's.....44337 \$4.75 ea.

Peppermint, 150's...44338 \$4.75 ea.

H. Ban-Acid Maximum Strength C Medique® chewable Tablets

(Compare active ingredient to TUMS® EX)

Extra strength calcium supplement for heartburn, sour stomach, indigestion and upset stomach. Contains: Calcium Carbonate 750mg.

UNIT DOSE

75 /2's..... 1006094 \$8.41 box

ANTIDIARRHEAL

I. Imodium® A-D

Imodium® A-D can help restore balance to your digestive system and it works even faster than the leading prescription anti-diarrheal.

4 oz. Liquid, Mint Flavor

.....34366 \$10.55 ea.

J. Kaopectate®

Anti-diarrheal and upset stomach reliever.

8 oz.....34013 \$9.63 ea.

K. Medique® Diamode

(Compare active ingredients to Imodium® A-D)

Clinically proven for control and symptomatic relief of acute non-specific diarrhea. Tablets.

UNIT DOSE

50 /1's.....44220 \$19.05 box

100 /1's.....44507 \$36.30 box

Antacids & Gastrointestinal



A



B



C



D



E

Sugar free!



F

NEW!



G



H

ANTI-NAUSEA

A. Medique® Medi-Meclizine, 50 mg (25 mg each tablet)

(Compare active ingredients to Dramamine® Less Drowsy Formula.) For prevention of nausea and vomiting associated with motion sickness.

UNIT DOSE

50/2's44312 \$15.10 box

B. Emetrol® Nausea Relief

Safe for children. No salicylates, antihistamines, alcohol, or caffeine. For relief of nausea due to upset stomach from intestinal flu, stomach flu, and food or drink indiscretions. Active ingredients per teaspoon: Dextrose (1.87 g.), Levulose (fructose) (1.87 g.), Phosphoric Acid (21.5 mg).

Cherry Flavor, 4 fl. oz. (118 mL)

.....34688 \$11.85 ea.

MULTI-SYMPTOM

C. Imodium® Multi-Sympton Relief

Relieves diarrhea, cramps, pressure, bloating, and gas.

Caplets, 12/pkg.....44574 \$8.73 box

Caplets, 18/pkg.....44575 \$11.25 box

Caplets, 30/pkg.....44576 \$18.75 box

D. Pepto Bismol® Original

For the fast relief of heartburn, sour stomach, acid indigestion, and upset stomach due to these symptoms.

8 oz. Liquid.....34016 \$8.98 ea.

16 oz. Liquid.....34294 \$12.50 ea.

48 Tablets.....44047 \$14.30 ea.

UNIT DOSE

25/2's44419 \$33.70 box

E. Children's Imodium

Controls symptoms of diarrhea. Ages 6 and up.

Mint, 4 oz.34850 \$8.70 ea.

F. Medique® Diotame—Sugar Free

(Compare active ingredients to Pepto-Bismol®.) Chewable, sugar-free antacid/diarrhea relief.

UNIT DOSE

Tablets

12/2's44548 \$5.11 box

15/2's.....44549 \$5.47 box

50/2's44118 \$15.40 box

250/2's.....44103 \$63.75 box

Liquid

20's34664 \$37.80 pkg.

POISON CONTROL

G. Actidose Aqua Charcoal Suspension

Used for accidental poisonings.

120 mL Bottle.... 1034682 \$33.60 ea.

H. E-Z Char Activated Charcoal Pellets

Used for accidental poisonings. Simply add water to bottle. Vented cap allows air to slowly escape, avoiding splatters. No clogging, clumping, or kneading. Single-use only.

25 gm.....44297 \$33.50 ea.

Medique Products

The Brands That WorkSM

Keeping Students Healthy
for over 35 years



Extra Strength APAP

High potency non-aspirin pain and fever relief.

250/2's 44101

Compare active ingredient to XS Tylenol®
Acetaminophen 500mg



I-Prin

Relief from fever and aches and pains associated with arthritis, menstrual cramps, colds, headache, toothache, muscular and backache.

250/2's 44289

Compare active ingredient to Advil®
Ibuprofen 200mg



Medi-Lyte

Sodium-free, sugar-free and lactose-free relief from heat stress, fatigue and muscle cramping due to minerals lost to heat and perspiration.

250/2's 44219

Calcium Carbonate 10.64mg;
Potassium Chloride 40mg;
Magnesium Oxide 12mg



Loradamed

Non-drowsy relief of symptoms due to hay fever and upper respiratory allergies such as runny nose, itchy, watery eyes, sneezing and itching of the nose or throat.

50/1's 43242

Compare active ingredient to Claritin®
Loratadine 10mg



Sore Throat Lozenges

Fast-acting relief from sore throat and minor mouth pain.

18/1's 44541

Menthol 3.6mg;
Benzocaine 15mg



Medikoff Drops

Menthol/eucalyptus vapor action cough drops clear nasal passages and provide temporary relief of minor throat irritation and coughs due to colds or inhaled irritants.

300/1's 44522

Menthol 5.8mg



Alcalak

Aluminum-free calcium supplement for heartburn, sour stomach, acid indigestion and upset stomach. Mint flavor.

100/2's 44309

Compare active ingredient to TUMS®
Calcium Carbonate 420mg



Diotame

Chewable, sugar-free antacid/diarrhea relief tablets. Soothes irritation with a protective coating action without constipating.

50/2's 44118

Compare active ingredient to Pepto-Bismol®
Bismuth Subsalicylate 262mg



Liquid Skin

100% waterproof bandage that stays on hard-to-cover areas! Forms a breathable, protective layer.

10/bag 1006096

Compare active ingredient to Chlor-Trimeton®
Chlorpheniramine Maleate 2mg



Hydrogen Peroxide

Local antiseptic to treat minor cuts and abrasions.

8oz 34011



Blood Clotting Spray

Helps stop superficial bleeding on contact and assists in fighting infection.

3oz can 50227



Eye Wash

Compare active ingredient to Dacriose®
Sterile irrigating solution

1oz 34105



Trauma Kit

Our standard trauma kit comes in sturdy cordura bag, perfect for first responders, and contains a mix of items for handling minor emergencies.

each 90894

Allergy, Cold & Flu



A



B



C



D



E



F



G



H

ALLERGY, COLD & SINUS

A. Advil® Cold and Sinus, Non-Drowsy

Relieves sinus pressure, nasal congestion, and fever. Ibuprofen 200 mg for pain relief and fever reducer. Pseudoephedrine HCl 30 mg for nasal decongestant. For use by adults and children 12 and up.

Caplets, 40/box **44342** \$19.00 box

B. Afrin® Nasal Spray

- Helps relieve nasal congestion
- Oxymetazoline HCL nasal solution-nasal decongestant
- 12 hour relief

.5 oz spray **1034506** \$13.75 ea.

C. Aleve® D Sinus and Cold, Non-Drowsy

All day multi-symptom relief of sinus pressure, headache, nasal, and sinus congestion. For use by adults and children 12 and up. 200 mg Naproxen, 120 HCl Pseudoephedrine.

UNIT DOSE
20/box **44277** \$17.40 box

D. Benadryl® Allergy

Relieves sneezing, runny nose, itchy throat, and watery eyes. Small tablet (Ultratab).

Ultratab, 24/pkg. **44601** \$6.88 pkg.
Ultratab, 48/pkg. **44602** \$13.30 pkg.

E. Claritin® D Allergy/Congestion 24-Hour

For use by adults and children 12 years and older.
10/box **44283** \$25.60 box

F. Medique® Chlorphen

(Compare active ingredients to Chlor-Trimeton.) For relief from hay fever and other symptoms of allergic reactions. For adults and children 12 and up.

UNIT DOSE
250/1's **44290** \$17.00 box

G. Medique® Diphen

(Compare active ingredients to Benadryl.) For relief from symptoms of allergic reactions. For use by adults and children 12 and up.

24/1's **44550** \$3.13 box
Capsules, 200/box **44209** \$17.05 box

H. Medique® Loradamed Non-Drowsy 24-Hour Allergy Relief Tablets

(Compare active ingredients to Claritin.) Relief of symptoms due to hay fever and upper respiratory allergies. For use by adults and children 12 and up.

UNIT DOSE
10 mg, 50/1's **43242** \$23.25 box

Diphenhydramine Children's Formula

(Compare active ingredients to Children's Benadryl.) Used to relieve symptoms of allergy and treat nausea, vomiting, and dizziness caused by motion sickness.

Cherry Flavor, Liquid, 8 oz.
. **34858** \$12.20 ea.
Caplets, 25 mg, 100/box
. **44359** \$6.08 box
Caplets, 25 mg, 1,000/box
. ***44358** \$33.20 box

* All prescription (Rx) purchases Requires Rx authorization form See "Medical Authorization Form" in the Index section. Please note: Epinephrine pens you receive have the best expiration date and price available at the time of purchase. Call Customer Care at 866-323-5465 with any questions.

ALLERGY, COLD & SINUS – CONTINUED

A. Sudafed® 12-Hour Caplets

A time-release formula for 12-hour, non-drowsy relief from sinus congestion and pressure. For use by adults and children 12 years and older. 120 mg. 10's44305 \$10.45 ea.

Sudafed® PE Pressure + Pain

Non-drowsy relief from headache, sinus congestion and pressure. Pain reliever and fever reducer, nasal decongestant. For use by adults and children 12 years and older.

Caplets, 24's44607 \$11.15 box

Sudafed® Pressure + Pain 12 Hour

Caplets, 16's44606 \$17.40 box

B. Zyrtec® Tablets

Temporarily relieves these symptoms due to hay fever or other respiratory allergies: runny nose, sneezing, itchy watery eyes, itching of the nose or throat. For use by adults and children 6 to 65 years old. 10 mg.

14's44432 \$26.60 ea.

C. Zyrtec-D® Tablets

Relieves the same symptoms as Zyrtec® and also nasal congestion. For use by adults and children 12 to 65 years old.

12's44431 \$26.45 ea.

D. Medi-First® Sinus Decongestant – Non-Pseudo

(Compare active ingredient to: Sudafed® PE) Pseudoephedrine Free sinus relief. Easy to swallow, film coated tablets.

24 /1's44554 \$3.25 box

100's44330 \$8.95 ea.

250's44329 \$16.50 ea.

500's44508 \$32.50 box

E. Medique® Medicidin D

(Compare active ingredients to Coricidin D) Effectively relieves irritating symptoms of cold, flu and allergies. For use by adults and children 12 and up.

UNIT DOSE

250 /2's44171 \$42.55 box

F. Medique® Non-Pseudo Sinus Pain/Pressure Relief

(Compare active ingredients to Tylenol Sinus) Relieves sinus pressure associated with allergies, headaches and colds. For use by adults and children 12 and up.

UNIT DOSE

50 /2's44332 \$8.91 box

125 /2's44331 \$16.45 box

250 /2's44343 \$32.90 box



A



B



C



D



E



F



G



H

Sugar Free!



I



Sugar Free!

J

COLD & COUGH

G. COLD-EEZE®

Shortens the life cycle of a cold. For use by adults and children 12 and up.

25's44278 \$12.90 ea.

H. Chloraseptic® Sore Throat Lozenges

Provides fast, long-lasting relief of sore throat and mouth pain. Soothing liquid center cools nasal passages.

Cherry Flavored

Lozenges, 18's44109 \$6.66 ea.

I. Halls® Cough Drops

For use by adults and children 5 and up.

Cherry, 30's44002 \$3.35 ea.

Honey-Lemon, 30's44030 \$3.35 ea.

Mentho-Lyptus, 30's44075 \$3.35 ea.

80's44555 \$8.35 ea.

Halls® Defense Cough Drops

Delivers 60 mg of Vitamin C per drop. For use by adults only.

Citrus, 30's44275 \$3.84 ea.

Cough Drops – Menthol

(Compare active ingredients to Hall's®)

Cherry, 40's44536 \$2.32 ea.

Honey-Lemon, 40's44535 \$2.32 ea.

Eucalyptus, 40's44537 \$2.32 ea.

J. Cough Drops – Sugar-Free Menthol

(Compare active ingredients to Hall's®)

Black Cherry, 25's44061 \$3.07 ea.

Cold, Cough & Flu

COLD & COUGH – CONTINUED



B



A



C



D



E



F



G



H



I



J

A. Halls Cough Drops

30/package

Cherry.....	44002	\$3.35 ea.
Honey-Lemon.....	44030	\$3.35 ea.
Menthol Lyptus.....	44075	\$3.35 ea.

B. Chloraseptic® Sore Throat Spray

Provides fast, long-lasting relief of sore throat pain and mouth, gum and throat irritations. Alcohol free, aspirin free, and sugar free. For use by adults and children 12 years and older.

6 oz. Pump, Cherry Flavored.....	34107	\$10.00 ea.
Menthol Flavored.....	34026	\$10.50 ea.

C. Best Health Sore Throat Lozenges

(Compare active ingredients Cepacol) Provides instant acting sore throat relief and the maximum strength numbing medication available per dose without a prescription. For use by adults and children, 6 and up. Active ingredient: Menthol 3.6mg; Benzocaine 15.0mg.

18/box.....	44541	\$4.40 box
-------------	-------	------------

D. Medique® Guaicon DMS

Liquid cough & cold relief for coughs caused by the common cold, bronchitis, and other breathing illnesses. Each 10 ml packet contains: Guaifenesin 200 mg; Dextromethorphan HBr 20 mg.

UNIT DOSE 20's.....	34578	\$21.90 ea.
------------------------	-------	-------------

E. Medique® Non-Pseudo Cold Relief

Multi-symptom formula relieves congestion, pain, cough and fever.

UNIT DOSE 50 /2's.....	44328	\$10.70 box
125 /2's.....	44327	\$21.75 box

COLD & FLU

DayQuil® PE Cold & Flu

For use by adults and children ages 12 and up.

UNIT DOSE 25 /2's.....	44423	\$31.60 box
---------------------------	-------	-------------

NyQuil®

For use by adults and children 12 and up.

Liquicaps, 24's.....	44534	\$16.85 ea.
----------------------	-------	-------------

G. NyQuil® PE Cold & Flu

For use by adults and children ages 12 and up.

UNIT DOSE 50 /2's.....	44426	\$30.10 box
---------------------------	-------	-------------

F. Medique® Medikoff Drops

(Compare active ingredients to Hall's) Menthol/ eucalyptus vapor action clears nasal passages and provide temporary relief of minor throat irritation. For use by adults and children, 12 and up.

Cherry 600 Wrapped-Bulk	44221	\$40.10 ea.
Menthol/Eucalyptus (Sugar Free) 300 Wrapped-Bulk	44522	\$40.75 ea.
UNIT DOSE Cherry, 12 /2's.....	44553	\$3.11 box

Sore Throat Spray

(Compare active ingredients to Chloraseptic)

6 oz. Pump Cherry.....	34184	\$8.08 ea.
Menthol.....	34185	\$8.08 ea.

Tussin DM Cough & Chest Congestion Syrup

(Compare active ingredients to Robitussin® DM) Controls cough and loosens and relieves chest congestion.

4 oz.	34411	\$4.23 ea.
------------	-------	------------

H. Children's Robitussin CF

Provides relief from cough, chest congestion, stuffy nose, and more. Loosens mucus for a more productive cough.

4 oz bottle, Grape	1034681	\$12.05 ea.
--------------------	---------	-------------

I. Vicks® VapoRub

For use by adults and children 2 years and older.

6 oz. Jar.....	43214	\$26.95 ea.
----------------	-------	-------------

J. Medique® CCP Caffeine-Free

Relieves aches and pains associated with colds and flu. For adults and children 12 and up.

UNIT DOSE 50 /2's.....	44287	\$14.25 box
---------------------------	-------	-------------

ACETAMINOPHEN

A. Tylenol® Regular Tablets – 325 mg. For use by adults and children 6 years and older.

100's44012 \$13.95 ea.

Acetaminophen – 325 mg.

(Compare active ingredients to Tylenol®) For use by adults and children ages 12 and up. Aspirin-free relief from pain and discomfort associated with colds, arthritis, headache, muscle ache, menstrual cramps and fever.

100's44058 \$2.42 ea.

UNIT DOSE

250/2's44098 \$19.55 box

B. Medique® APAP

Provides aspirin-free relief from pain and discomfort associated with colds, arthritis, headache, muscle ache, menstrual cramps and fever. It can effectively be used as a pain reliever and fever reducer. Compare active ingredients to Tylenol.

UNIT DOSE

12/2's44543 \$2.50 box

C. Medique® Back Pain-Off

(Compare active ingredients to Excedrin) Temporary relief of back pain and inflamed joints of the lumbar and sacral regions. For use by adults and children 12 years and older. Acetaminophen and caffeine formula. Easy to swallow coated tablets.

250/2's44207 \$55.80 box

50/2's44208 \$14.45 box

12/2's44546 \$3.74 box

ACETAMINOPHEN – EXTRA STRENGTH

D. Tylenol® Extra Strength – 500 mg.

For use by adults and children 12 years and older.

Caplets, 100's44064 \$18.45 ea.

UNIT DOSE

Caplets, 50 /2's44113 \$22.50 box

E. Medique® Pain-Off Extra Strength

(Compare active ingredients to Extra Strength Excedrin) For extra strength relief from pain. For use by adults and children 12 years and older.

100's44308 \$8.56 ea.

UNIT DOSE

250/2's44291 \$39.95 box

Acetaminophen Extra Strength Rapid Release

(Compare active ingredients to Tylenol Extra Strength Rapid Release Gel caps)

UNIT DOSE

100/2's44513 \$12.55 box

F. Medique® APAP Ex-Strength – 500 mg.

(Compare active ingredients to Extra Strength Tylenol) High potency, aspirin-free, Acetaminophen pain relief.

Tablets, 100's44096 \$3.95 ea.

UNIT DOSE

250 /2's44101 \$30.20 box

125/2's44516 \$17.30 box

50/2's44514 \$7.95 box

12/2's44544 \$3.29 box

NAPROXEN

G. Aleve® Caplets – 220 mg.

Long lasting pain reliever and fever reducer. For use by adults and children 12 years and older.

100's44018 \$23.80 ea.

UNIT DOSE

50 /1's44267 \$27.65 box

H. Medique® Mediproxen

(Compare active ingredients to Aleve®) For use by adults and children 12 years and older.

UNIT DOSE

100 /1's44202 \$24.40 box



A



B



C



D



E



F



G



H

**MORE
ONLINE**

For our full selection of Sports Medicine Pharmacy products go to: SchoolHealth.com/Sports-Medicine/Pharmacy

Pain Relief



A



C



D



E



F



G



H



I

ASPIRIN

A. Bayer® Aspirin – 325 mg.

For use by adults and children 12 years and older.

100's44020 \$13.40 ea.

UNIT DOSE

50 /2's44409 \$27.30 box

Medi-First Aspirin

Includes 50 tamper-evident dose packets with two tablets each. Treats headaches, minor muscle soreness, and arthritis. Easy-dispensing box design.

325 mg, 100 count 1034503 \$3.99 ea.

Medique® Aspirin – 325mg

(Compare active ingredients to Bayer®)

UNIT DOSE

50 /2's44545 \$2.49 box
250 /2's44099 \$18.10 box

IBUPROFEN

B. Advil® – 200 mg.

For use by adults and children 12 years and older.

100's44065 \$20.20 ea.

UNIT DOSE

50 /2's44013 \$20.75 box

Advil® Liqui-Gels – 200 mg.

50 /2's44293 \$32.75 box

C. Motrin IB® Caplets – 200 mg.

For use by adults and children 12 years and older.

Caplets,100's44071 \$17.45 ea.

UNIT DOSE

50 /2's44231 \$19.65 box

Ibuprofen Caplets

(Compare active ingredients to Motrin IB Caplets)

100/bx44480 \$3.46 box

D. Medi-First Ibuprofen Tablets – 200 mg.

(Compare active ingredients to Advil/Motrin) For use by adults and children 12 years and older.

100's44106 \$6.47 ea.
500's44067 \$20.90 ea.

UNIT DOSE

250 /2's44189 \$30.70 box

E. Medique® I-Prin – 200 mg.

(Compare active ingredients to Advil) Relief from fever, aches and pains. For use by adults and children 12 years and older. Ibuprofen.

UNIT DOSE

12 /2's44551 \$3.28 box
100 /2's44515 \$15.95 box
250 /2's44289 \$33.45 box

INHALANT STIMULANT

F. Ammonia Inhalant Capsules

Aromatic stimulant to assist in reviving victims of fainting or shock.

10/box49144 \$3.80 box

G. Ammonia Spirits

Respiratory stimulant for reviving persons after fainting.

2 oz.34005 \$7.19 ea.

MENSTRUAL PAIN RELIEF

H. Midol® Menstrual Complete

Relieves menstrual symptoms. For use by adults and children 12 years and older.

24's44028 \$11.90 ea.

I. Medique® Cramp Tabs Pain Reliever

(Compare active ingredients to Midol) For use by adults and children 12 years and older.

UNIT DOSE

50 /2's44441 \$8.71 box
250 /2's44442 \$38.15 box

MORE ONLINE

For our full selection of Sports Medicine Pharmacy products go to: SchoolHealth.com/Sports-Medicine/Pharmacy

HYDRATION & HEAT RELIEF

Fosfree Soluble Calcium with Vitamins

Stops troublesome muscle cramping.

120's	44080	\$17.40 ea.
500's	44004	\$75.10 ea.

A. Gatorade® - 20 oz.

Formulated to rehydrate and replenish fluid, carbohydrates and electrolytes.

Lemon Lime, 24/case		
.....	38072	\$37.99 cs.
Orange, 24/case.....	38073	\$37.99 cs.

Heat Guard Slow Release Electrolyte Replenisher

Designed to provide the slow release of the tablet's salt content over a period of four hours.

1000's.....	44223	\$87.85 ea.
-------------	-------	-------------

B. Honeysuckles

Simple to use. Just squeeze the end to release.

Clover, 100/pkg.....	34198	\$48.85 pkg.
----------------------	-------	--------------

HYGIENE

E. Degree Women's Invisible Solid, Shower Clean

Expert protection. 24 hour Motion Sense. Motion activated freshness. Antiperspirant and Deodorant.

0.5 oz	44505	\$1.95 ea.
--------------	-------	------------

F. Degree Men's Invisible Solid, Extreme Blast

Degree Men's Invisible Solid's body response formula releases extra protection when you need it most.

1.6 oz.....	44506	\$5.13 ea.
-------------	-------	------------

Deodorant – Dial®

Combines a powerful anti-wetness ingredient and special deodorant ingredients to fight odor causing bacteria.

1.5 oz. Roll-On	44092	\$2.51 ea.
-----------------------	-------	------------

G. Right Guard Sport Deodorant

This antiperspirant aerosol is waterproof, stink proof, and embarrassment proof too. Up to 24 hour sweat and odor defense that dries on contact. Long lasting protection up to 24 hours.

6 oz. Aerosol, Powder Dry		
.....	1008218	\$7.29 ea.

Shower Soap

Hard-milled body and face bar lasts longer, rinses clean in any water. Coconut oil conditions skin.

3 oz. Bar.....	44052	\$1.21 ea.
----------------	-------	------------

C. Pedialyte® – Liter

Used to prevent dehydration due to diarrhea or vomiting.

Fruit.....	34870	\$11.20 ea.
------------	-------	-------------

D. Medique® Medi-Lyte Electrolyte Replenisher Tablets

Helps provide temporary relief from heat stress, fatigue and muscle cramping by replenishing minerals lost to heat and perspiration. Sodium-free, sugar-free and lactose-free. Active ingredients: potassium chloride (40 mg.), calcium phosphate (18 mg.) and magnesium carbonate (9 mg.).

UNIT DOSE

50 /2's.....	44218	\$7.55 box
250 /2's	44219	\$25.85 box

H. PURELL Hand Sanitizing Wipes

Kills 99.99% of common germs that may cause illness. Use anytime for quick cleanup when soap and water are not available. Durable, textured wipe sanitizes hands while wiping away light soils; dries quickly. No harsh chemicals, safe to use on skin and surfaces.

40 Count

Clean Refreshing .	1006385	\$6.17 ea.
Fragrance Free . . .	1006386	\$6.18 ea.

I. Green Soap Germicide

Tincture product. Germicidal skin cleanser made from pure vegetable soap in a 32% alcohol solution. Used as a medicinal shampoo for dandruff and dermatitis. Often used after exposure to plant toxins such as poison ivy.

16 oz.....	34044	\$7.01 ea.
Gallon	34045	\$26.95 ea.

J. Hygea® Sterile Saline Wipes

Safely cleanses the exterior areas of the eye in newborns. Ideal for post-operative eye care and dressing changes in the hospital and home.

24/box	49142	\$6.54 box
--------------	-------	------------

K. Wet Ones®

Kill 99.99% of germs. Thick and strong, yet gentle enough to care for little hands and faces.

40/canister	49190	\$5.29 ea.
-------------------	-------	------------



A



B



C



D



E



F



G



H



I



J



K

FREE SHIPPING at SchoolHealth.com/SportsMed

Get FREE SHIPPING on your online order over \$100! Go to the back cover for Free Ship Online code. Can only be used once per customer. Expires 12-31-20.

Ophthalmics



A

A. *SH* School Health Brand Contact Lens Emergency Kit

Contents:
 (1) Pocket Pack (1) Multi-Purpose Solution, 4 oz.
 (2) pr. Latex Unisize Gloves (1) Pocket Mirror
 (2) Contact Lens Cases (1) Penlight
 (1) Eye Wash, 4 oz.
90236 \$29.36 kit



B



C

Bausch & Lomb® Renu Multiplus®
 Effectively kills germs in just 4 hours – so it helps keep your soft contact lenses comfortable and your eyes healthy.
 4 oz. 1008121 \$7.03 ea.

Bausch & Lomb® Sensitive Eyes Saline Solution

Use for rinsing after daily cleaning, as a final rinse after disinfection, and prior to lens insertion.
 12 oz. 34232 \$7.54 ea.

B. Bausch & Lomb® Soothe
 Single-Use Dispensers. Clinically proven to soothe dry and irritated eyes.

UNIT DOSE
 0.02 oz., 28/box. 34533 \$15.80 box



D

Disposable Fluorescent Strips
 100/box 44303 \$29.55 box

Bausch & Lomb® Sight Savers® Lens Cleaning Tissues
 For glass and plastic lenses. Anti-fog; anti-static.
 30/pkg 49181 \$2.90 pkg.



F



E

C. Clear Eyes® - Contact Lens Relief
 Moistens soft lenses and refreshes eyes.
 0.5 oz. 34213 \$7.02 ea.

Contact Lens Cases
 Convenient and affordable.
 2/pkg. 90984 \$3.23 pkg.



G

D. Eye Cups
 Plastic, Sterile Disposable
 90069 \$2.58 ea.
 Plastic, Non-Sterile Disposable
 6/pkg. 90561 \$3.14 pkg.

E. Single Use Eyewash
 Refreshes and cleanses tired and irritated eyes. Sterile irrigating solution flushes particles from eyes quickly.
 0.5 oz. 34694 \$3.06 ea.
 1 oz. 42085 \$3.24 ea.
 4 oz. 34105 \$3.91 ea.
 16 oz. 55919 \$7.47 ea.

Fog Eliminator Cloths
 Shields glasses and goggles from fog buildup caused by humidity or climate change. Alcohol-free and safe for use on polycarbonate, plastic and glass lenses. One cloth provides multiple streak- and film-free applications.

Foil Pack, 100/box
 49090 \$299.50 box

F. Refresh Plus®
 Immediate, long-lasting relief for dry, scratchy eyes. Restores moisture, while creating a shield of protection against further irritation. Contains no preservatives.
 30/box 34368 \$19.95 box

G. Visine® Products
Original Eye Drops
 Removes redness and moisturizes eyes.
 0.5 oz. 34360 \$8.40 ea.

A.C. Astringent Redness Reliever Drops
 Relieves eye discomfort due to minor eye irritations as well as seasonal itching and redness relief.
 0.5 oz. 34359 \$8.40 ea.

For Contacts® Lubricating and Rewetting Drops
 It refreshes eyes, moistens lenses and helps remove particulate matter that can cause irritation and discomfort.
 0.5 oz. 34358 \$8.40 ea.

Saline Sterile Eyewash
 Single-use Bottle
 1 oz. 42068 \$4.06 ea.
 4 oz. 42067 \$6.15 ea.
 8 oz. 42066 \$7.54 ea.

EMERGENCY

Dental Emergency Kits

Contains everything you need for emergency dental repairs until you can get to a dentist.

Deluxe Kit Includes:

- (2) Temporary Cement Packets
- (2) Temporary Fillings
- (2) Dental Wax Packets
- (1) Toothache Drop (1cc)
- (1) Denture Repair Fluid (1cc)
- (2) Denture Repair Powder
- (2) Mini Mixing Bowls
- (2) Toothpicks
- (1) Tweezer
- (1) Mixing Tool
- (1) Instruction Sheet
- (2) Cotton Swabs
- (2) Gauze Sponges
- (1) Carrying Case

Mini Kit Includes:

- (1) Temporary Cement Packet
- (1) Temporary Filling
- (1) Dental Wax Packet
- (1) Toothache Drop (1cc)
- (1) Denture Repair Fluid (1cc)
- (1) Denture Repair Powder
- (1) Mini Mixing Bowl
- (1) Toothpick
- (1) Tweezer
- (1) Mixing Tool
- (1) Instruction Sheet
- (1) Cotton Swab
- (2) Gauze Sponges
- (1) Carrying Case

A. Deluxe Dental Emergency Kit **47013** \$37.89 kit

B. Mini Dental Emergency Kit **47014** \$26.99 kit

C. EMT ToothSaver™

Helps protect a knocked-out tooth from cell damage and dehydration. Tooth can be safely stored up to 24 hours until replantation.

..... **47005** \$15.99 ea.

D. Save-A-Tooth®

Nourishes and revives knocked-out teeth for replantation.

..... **47028** \$18.59 ea.

LIP BALM

E. Carmex®

Relieves the symptoms of chapped lips and cold sores.

0.25 oz. Jar **43167** \$1.89 ea.

0.35 oz. Tube. **43206** \$1.89 ea.

F. Chapstick®

Helps prevent and temporarily protects chafed, chapped or cracked lips.

Original. **43048** \$2.39 ea.

Essential Lip Moisturizer in Fishbowl

Help protect lips from dryness with aloe and vitamin E. SPF-15 sunscreen protection. 0.1 oz. tubes.

100/pkg. **43329** \$69.00 pkg.

G. Safetec Lip Balm

Pomegranate flavored natural emollients to soothe and heal dry, chapped or painful lips. Single-use 0.5g packets.

144/box **43352** \$9.29 box

ORAL PAIN RELIEF

Anbesol® Oral Antiseptic

Temporarily relieves pain associated with mouth and gum irritations.

H. Gel, 0.33 oz. 43202 \$8.69 ea.

I. Orajel™ Pain Relief - Maximum Strength

Effective relief for toothache and gum pain. Antiseptic to help prevent infection. Maximum Strength, 20% benzocaine.

0.25 oz. **43155** \$9.89 ea.

J. Safetec Oral Pain Relief

Temporarily relieves pain caused by toothache, canker sore, gum sore, dental work, cheek bite, and other mouth irritations or injuries. Individual use 0.75 g packets.

144/box **43353** \$13.89 box

ORTHODONTIA

Brace Wax Squares

12 pre-measured squares of clear silicone wax to mold over brackets, wires, or teeth to form a protective guard. Pliable wax can be removed and reapplied. Carry case includes mirror for easy application; color may vary.

..... **47029** \$0.84 ea.

K. Orthodontic Wax

Adheres to orthodontic appliances to help relieve irritated tissue. With Vitamin E.

..... **47009** \$2.39 ea.

24/case. **47044** \$36.99 ea.



A



B



C



D



E



F



G



H



I



J



K

Screening Tests



A. Hema-Combistix

Test for urinary glucose, protein, pH and blood.

Test Strips, 100/box
44174 \$116.50 box

B. Multistix 10SG

Tests for urinary blood, bilirubin, urobilinogen, ketones, protein, nitrite, glucose, pH, specific gravity and leukocytes. Test Strips.

100/box44193 \$93.90 box

Chemstrip 7

Test for urinary glucose, protein, pH, blood, ketones, nitrites and leukocytes. Test Strips.

100/box44292 \$100.50 box

C. Labstix

Test for urinary glucose, protein, pH, blood, and ketones. Test Strips.

100/box44089 \$121.00 box

D. Uristix® Regent Stix

Test for urinary protein and glucose. Test Strips.

100/box44093 \$45.40 box

GEN 10SGL

(Comparable to Multistix 10SG) Test Strips.

100/box44194 \$64.25 box

GEN-GP2

(Comparable to Uristix) Test Strips.

100/box44183 \$24.75 box

6 L Urinalysis Strips

Test for blood, protein, nitrites, pH, urinary glucose and leukocytes. Test Strips.

100/box44385 \$44.50 box



Alco-Screen Saliva Alcohol Test

For use as a rapid, highly sensitive method to detect the presence of

alcohol in saliva and to provide a semi-quantitative approximation of blood alcohol concentration. Shelf life of 12 months.

24/box90281 \$72.80 box



DrugConfirm 12-Panel Urinalysis Drug Test

DrugConfirm™ is a urine drug test kit, maintaining 99% reporting accuracy at home or in the workplace. The 12 panels are configured to detect the most common drugs of abuse. The integrated dip

card yields result within 5 minutes or less, and can be sent to a laboratory for confirmation testing. CLIA-Waived, FDA 510(k) Approved & CE Marked. Made in the USA

.....91461 \$29.30 ea.



SteroidConfirm Steroid Urinalysis Test Kit

Accurate and affordable diagnostic anabolic steroids test for convenient use in the home, workplace or school, utilizes the most sophisticated, sensitive technology available.

- Use of LC/MC/MC technology
- Laboratory and 2-Day FedEx shipping included
- Medical Review Officer reviews all results
- Secure Online Results

.....91252 \$186.00 ea.



OSOM® MONO Test

CLIA waived (whole blood). Easy to read two color results. 100% sensitivity, 96% specificity. Results in 5 minutes. 12 month room temperature storage.

25/box90620 \$128.00 box



OSOM® Ultra Flu A & B Test

The OSOM Ultra Flu A & B Test is an in vitro rapid qualitative test that detects influenza type A and type B nucleoprotein antigens directly from nasal swab, nasopharyngeal swab, and nasopharyngeal aspirate/wash specimens obtained from patients with signs and symptoms of respiratory infection.

.....1031184 \$398.99 box



QuickVue® Dipstick Strep A Test

Allows for the rapid qualitative detection of Group A Streptococcal antigen directly from patient throat swab specimens; results in five minutes; with overall accuracy 95%; sensitivity 92%; specificity 98%.

50/box90786 \$167.50 box



QuickVue In-Line® Strep A Test

Unique In-Line immunoassay for the rapid qualitative detection of group A Streptococcal antigen from throat swab specimens. Results in five minutes or less with 96% overall agreement to culture; one easy step; single reagent method allows for less chance of operator error; individually packaged for convenient single-use testing and disposal; CLIA-waived.

25/box90493 \$155.50 box



Specimen Containers

4 oz. specimen containers with lids.

25/bag 21096 \$5.23 bag \$5.05 bag

ANTI-FUNGAL

A. Gold Bond™ Extra-Strength Powder

Relieves and prevents skin discomfort.

4 oz.....44315 \$8.20 ea.

Gold Bond™ Medicated Powder

Relieves and prevents skin discomfort.

10 oz.....44185 \$13.15 ea.

B. Micatin®

Used to treat skin infections such as athlete's foot, jock itch, ringworm, and other fungal skin infections.

0.5 oz. Cream43145 \$12.95 ea.

Carrington Antifungal Cream

A must for wrestling or any athlete, use this smooth and soothing cream to repel moisture and cure athlete's foot, jock itch and ringworm. Keep a tube in your locker or gym bag.

5 oz.....43180 \$20.25 ea.

A



B



C



D



ANTI-INFLAMMATORY

C. BIOFREEZE®

A unique, effective analgesic formulated to provide a variety of benefits for therapy, pain relief, exercise/training and overall comfort. BIOFREEZE products contain ILEX, an herbal extract from a South American holly shrub. ILEX is used around the world in various health and wellness formulations. BIOFREEZE products do not use waxes, oils, or petroleum. The result is a fast-acting, penetrating, long lasting pain reliever.

3 oz. Roll-On.....43163 \$11.55 ea.

4 oz. Tube.....43096 \$11.55 ea.

16 oz. Pump Bottle . .43065 \$41.75 ea.

D. Preparation H®

Ointment relieves both internal and external hemorrhoidal symptoms.

2 oz.....43210 \$22.05 ea.

ANTISEPTIC

E. Bactine®

Relieves the pain and itch of minor cuts, scrapes and burns on contact as it kills germs.

5 oz. Pump.....50035 \$9.11 ea.

F. Band-Aid® Hurt-Free Antiseptic Wash

Relieves pain while cleaning cuts and scrapes.

6 oz.....34263 \$5.46 ea.

E



F



FREE SHIPPING at SchoolHealth.com/SportsMed

Get FREE SHIPPING on your online order over \$100! Go to the back cover for Free Ship Online code. Can only be used once per customer. Expires 12-31-20.

Skin Care



A



B



C



D



E

ANTISEPTIC - CONTINUED

A. Betadine® Topical Antiseptic Bactericide

Use to kill germs in minor burns, cuts and scrapes.

8 oz. Solution	34009	\$6.46 ea.
16 oz. Solution	34010	\$9.76 ea.
Gallon	34046	\$61.10 ea.

B. PDI® Povidone Iodine Prep Pads

Provides germicidal activity that is non-irritating and virtually non-stinging. Perfect for venipuncture and IV starts.

100/box	49053	\$8.40 box
-------------------	--------------	------------

C. Puritan® Povidone Iodine Popule™

Prefilled with bacteria-reducing povidone iodine (10%; equal to 1% available iodine).

150/box	49128	\$9.25 box
-------------------	--------------	------------

D. Povidone Iodine Spray

This multi-purpose topical solution contains 10% Povidone Iodine USP, 1% available Iodine. Single use spray bottle eliminates the possibility of cross contamination. A no touch application for abrasions, lacerations and burns. Microbiocide of choice for disinfection and wounds.

2 oz. Spray Bottle.	50210	\$9.97 ea.
-----------------------------	--------------	------------

ANTISEPTIC - ITCH & PAIN RELIEF

E. Calagel® Medicated Anti-Itch Gel

First aid antiseptic, skin protectant, topical analgesic. Dries poison oak, ivy and sumac oozing and weeping.

UNIT DOSE

1/32 oz, 144/box	43281	\$37.85 box
----------------------------	--------------	-------------

Alcohol

Use for simple wound disinfections.

Ethyl (70%)

16 oz.	34040	\$3.22 ea.
----------------	--------------	------------

Isopropyl (70%)

2 oz. Spray.	1005951	\$3.21 ea.
----------------------	----------------	------------

16 oz.	34042	\$2.21 ea.
----------------	--------------	------------

32 oz.	34147	\$4.54 ea.
----------------	--------------	------------

Isopropyl (99%)

16 oz.	34237	\$3.07 ea.
----------------	--------------	------------

Benzalkonium Chloride Solution

16 oz. Solution	34680	\$5.48 ea.
---------------------------	--------------	------------

Gallon Solution.	34681	\$21.45 ea.
--------------------------	--------------	-------------

Hydrogen Peroxide - 3% Solution

First aid antiseptic. For treatment of minor cuts and abrasions. Also can be used as an antiseptic gargle or rinse.

8 oz.	34011	\$1.26 ea.
---------------	--------------	------------

16 oz.	34041	\$1.22 ea.
----------------	--------------	------------

2 oz. Spray.	1005950	\$3.06 ea.
----------------------	----------------	------------

Medique® Antiseptic Spray

Not for use by children. Non-staining.

3 oz. Aerosol	1005949	\$3.63 ea.
-------------------------	----------------	------------

Povidone Iodine Swabs

Ideal for venipuncture, IV starts, renal dialysis and pre-op prepping.

50/box	49128	\$9.25 box
------------------	--------------	------------

Hydrocortisone Cream

Reduces itching, redness, and swelling associated with many skin conditions.

1%, 1 oz.	43134	\$3.52 ea.
-------------------	--------------	------------

1% with Aloe, 1 oz		
--------------------	--	--

.	43286	\$3.47 ea.
-----------	--------------	------------

UNIT DOSE

0.9g Foil 144/Bx		
------------------	--	--

.	1003410	\$27.85 box
-----------	----------------	-------------

**MORE
ONLINE**

For our full selection of Sports Medicine Pharmacy products go to: schoolhealth.com/sports-medicine/pharmacy.

CLEANSER

A. Albolene® Moisturizing Cleanser

Great for makeup removal. Dermatologist recommended, fragrance free.

12 oz.43201 \$21.55 ea.

B. Phisoderm® Deep Cleaning Skin Cleanser

Specially formulated to restore your skin's natural balance. No matter if your skin is normal, dry or oily, you can trust their 40 years of skin care experience for a glowing complexion.

6 oz.43042 \$7.51 ea.

FIRST AID OINTMENT & CREAM

C. Neosporin® Ointment

Provides long-lasting infection protection and may help minimize the appearance of scars.

1 oz.43030 \$10.20 ea.

D. Polysporin® Ointment

First aid to help prevent infection in minor cuts, scrapes, and burns.

1 oz.43299 \$13.45 ea.

A&D Ointment®

Skin protectant and diaper rash ointment

1 oz. Tube. 1008060 \$2.59 ea.

4 oz. Flip-cap Tube 1008061 \$4.89 ea.

15 oz. Jar43033 \$15.99 ea.

UNIT DOSE

Foil Pack, 144's.43143 \$21.79 box

Bacitracin Zinc

Helps prevent infection and the spread of harmful bacteria. Apply to minor cuts, burns and scrapes.

.5 oz.43264 \$2.94 ea.

1 oz.43009 \$4.01 ea.

4 oz.43010 \$14.30 ea.

UNIT DOSE

Foil Pack, 144's.43008 \$37.80 box

INSECT - BITE RELIEF

E. Bee Venom Cleanser

Herbal remedy providing relief from insect stings and bites.

0.5 oz. Bottle.34193 \$12.00 ea.

F. Sawyer's Bite and Sting Extractor Kit

The Extractor vacuum pump painlessly extracts the poison from stings and bites by creating a vacuum on the surface of the skin. Kit includes "The Extractor" vacuum pump, safety razor (for body hair removal), bandages, and antiseptic.

.....42003 \$26.05 kit

INSECT - REPELLENT

H. Off!® Family Care Insect Repellent

Unscented with Aloe Vera. Contains approximately 7% DEET. Protects for up to 2 hours.

6 oz.50101 \$9.36 ea.

Epsom Salt

Epsom salt is a natural exfoliate. Mix it with your normal facial cleanser for smoother skin.

16 oz.44254 \$2.69 ea.

Witch Hazel Astringent

16 oz.34064 \$5.18 ea.

First Aid Cream

0.875 oz.43262 \$2.31 ea.

1.5 oz.43263 \$3.00 ea.

Triple Antibiotic Ointment

Use this single antibiotic ointment to treat all kinds of minor cuts, burns and abrasions. Helps prevent infection and aids in healing.

0.5 oz.43265 \$3.19 ea.

1 oz.43013 \$4.88 ea.

UNIT DOSE

Foil Pack, 144's.43012 \$38.15 box

Zinc Oxide

Used to treat or prevent minor skin irritations such as burns, cuts, and diaper rash.

1 oz.43034 \$1.99 ea.



A



B



C



D



E



F



G



H

G. TICKED OFF Tick Remover

A simple-to-use tool proven to remove crawling or attached ticks safely from people or animals.

.....90451 \$5.70 ea.

Sting Relief Products

First aid analgesic for the temporary relief from the pain of insect bites and stings, scrapes and burns.

Swabs, 10/box49143 \$4.80 box

Swabs, 100/box49073 \$48.07 box

Wipes, 10/box49007 \$4.80 box

Skin Care



A



B



C



D



E



F



G



H



I

ITCH/PAIN RELIEF

A. Benadryl® Itch Stopping Cream

The histamine blocker. Extra strength itch relief for insect bites and skin irritations. Topical analgesic skin protectant. For use by adults and children 2 years and older.

2%, 1 oz. **43120** \$7.98 ea.

B. Caladryl® Lotion

A skin protectant and topical analgesic drug product. It temporarily relieves pain and itching and contains Calamine and Pramoxine HCl as its active ingredients. For children under 2 years of age, consult a doctor.

6 oz. **43039** \$10.15 ea.

C. Ivarest® - Poison Ivy Itch Relief

Antihistamine and analgesic anti-itch cream that provides temporary relief from the pain and itching associated with poison ivy, oak & sumac, insect bites, and minor skin irritations.

2 oz. **43123** \$8.51 ea.

Ivy Dry® for Skin Irritations Quickly relieves itching from poison ivy, oak, sumac and insect bites.

1 oz. Cream **43069** \$12.60 ea.

D. Ivy-Rid®

Relieves the itching and discomfort of poison ivy and insect bites.

2.75 oz. Aerosol. **50085** \$6.87 ea.

E. Water-Jel Itch Relief

External analgesic - 2% Diphenhydramine Hydrochloride. Maximum strength antihistamine non-aerosol spray for relief of discomfort and itch from insect bites and rashes due to poison ivy, poison oak and sumac.

2 oz. **50122** \$4.57 ea.

F. Calamine Lotion

Calamine lotion (for the skin) is used to treat itching and skin irritation caused by chickenpox, insect bites or stings, measles, eczema, sunburn, poison ivy, and other minor skin conditions.

6 oz. **1034910** \$3.75 ea.

2% Diphenhydramine Cream

(Comparable to 2% Benadryl Cream)

Stops itching at the source by blocking histamines that cause itch

1.25 oz tube **1034505** \$3.81 ea.

Caladryl Clear Anti-Itch Lotion

(Comparable to Caladryl)

Temporarily relieves itching and pain caused by minor cuts/scrapes, insect bites, minor skin irritations, or rashes from poison ivy, poison oak, or poison sumac.

6 oz. **43375** \$10.15 ea.

Hydrocortisone Cream

Reduces itching, redness, and swelling associated with many skin conditions.

1%, 1 oz. **43134** \$3.52 ea.

1% with Aloe, 1 oz. **43286** \$3.47 ea.

UNIT DOSE

.9%, Foil Pack, 144's
. **1003410** \$27.85 box

LUBRICANT AND PROTECTANT

G. Chafezone

The superior formulation glides on to prevent rubbing, chafing, and irritation. A quick swipe of ChafeZone banishes chafing discomfort from running, riding, hiking, cycling, dancing, body armor, heavy packs or new footwear. It's also a great prevention tool of ChubRub. ChafeZone helps protect your skin by preventing friction that can cause painful skin irritations. Long lasting, easy to apply and durable make ChafeZone a great alternative to prevent, chafe, chub rub and other skin irritations related to friction.

Roll on
1.5 oz. **1006610** \$19.05 ea.

H. Vaseline Chesebrough® Pond's

Protects skin from the effects of weather and exposure.

1 oz. Tube. **43025** \$2.21 ea.

3.25 oz. Tube. **43026** \$3.42 ea.

13 oz. Jar **43028** \$7.46 ea.

Vaseline White Petroleum Jelly

Protects skin from the effects of weather and exposure and acts like a sealant by forming an occlusive barrier to the natural water loss of our skin. So skin is protected from drying elements, enabling skin-softening moisture to build up naturally from inside the skin itself.

3.25 oz Tube **43026** \$3.42 ea.

I. K-Y Jelly®

A clear, non-greasy lubricant. Gentle and safe, water-soluble.

4 oz. **43059** \$7.34 ea.

Petroleum Jelly

(Comparable to Vaseline Chesebrough® Pond's)

Soothes minor skin irritations due to minor burns, scrapes, abrasions, and minor injuries.

13 oz. Jar **43053** \$4.02 ea.

UNIT DOSE

Foil Pack, 144's. **43055** \$23.75 box



MOISTURIZER

A. Aquaphor® Original Ointment

Skin protectant. Clinically proven to restore severely dry, cracked skin back to smooth, healthy skin.

- 1.75 oz. Tube 43106 \$9.32 ea.
- 14 oz. Jar 43105 \$26.05 ea.

B. Aveeno® Lotion

Helps prevent and protect dry skin, leaving it feeling soft, smooth and naturally healthy looking. It's fragrance free, non-greasy, noncomedogenic and gentle enough for everyday use — good for sensitive skin.

- 12 oz. Pump. 34550 \$13.60 ea.

C. Eucerin Calming Itch Relief Treatment

Cooling menthol in an oatmeal formula, external analgesic lotion, non-irritating, fragrance-free, dermatologist recommended dry skin therapy.

- 6.8 oz 43381 \$13.10 ea.
- 8 oz 43391 \$15.15 ea.

D. Eucerin® Original Crème & Lotion

Gentle, effective moisturizing relief for dry and sensitive skin.

- Crème, 4 oz. 43114 \$13.60 ea.
- Lotion, 8.4 oz. 43108 \$13.55 ea.
- Lotion, 16.9 oz. 43107 \$19.35 ea.

E. Eucerin® Replenish Lotion

This light, everyday formula with nourishing sunflower oil absorbs quickly and provides 24 hour moisturization for healthier-looking, softer skin.

- 16.9 oz. 43449 \$19.70 ea.

F. Jergens® Original Scent Cherry-Almond Moisturizer

Transforms dry skin into soft skin. Enriched with emollients and subtly fragranced with the classic Cherry-Almond scent. Dermatologist tested.

- 10 oz. 43252 \$7.74 ea.

G. Lubriderm® Lotion

Fragrance free Lubriderm Lotion with vitamin B5 and skin-essential moisturizers found in healthy skin. It's clinically shown to lock in moisture for 24 hours.

- Unscented, 16 oz. . . . 43209 \$14.75 ea.

H. Nivea® Moisturizer

A rich, creamy moisturizer that smooths and softens every inch of skin. An intensive moisturizing solution for extremely dry skin. Can be used all over the body, and best for rough spots such as knees, feet, elbows and hands. Contains almond oil.

- Essentially Enriched
- 6.8 oz 43422 \$6.35 ea.
- 16.5 oz 43423 \$13.20 ea.

I. Vaseline Intensive Care® Lotion

A multi-vitamin moisturizer. It replenishes 100% of daily hydration, along with the nutrients that skin needs. Key Ingredients: Vitamins A, E, & minerals.

- 24 oz. 43152 \$11.95 ea.

J. Remedy Olivamine Skin Repair Cream

- Protect and relieve damage from hand washing.
- CHG and latex friendly
- 4 oz Scented 43409 \$8.34 ea.
- 4 oz Unscented. 43410 \$8.34 ea.

Aloe Vera Moisturizing Gel

Forms a protective barrier that helps retain moisture and promotes healing.

- 6 oz. 43328 \$7.11 ea.
- 8 oz. 43159 \$9.77 ea.

UNIT DOSE

- Foil Pack, 36's 43160 \$21.00 box

Skin Care



A



B



C



D



E



F



G



H



I

RASH RELIEF & PREVENTION

A. Witch Hazel

Witch Hazel is a naturally effective herbal extract with exceptional cleansing, soothing, and healing properties. The Witch Hazel plant contains therapeutic constituents that when extracted and distilled create the clear, fragrant, natural astringent that has been known for generations as the most gentle natural skin care solution. Contains Natural Alcohol 14% and Witch Hazel Extract.

16 oz. **34064** \$5.18 ea.

A&D Ointment®

Skin protectant and diaper rash ointment

1 oz. Tube. **1008060** \$2.59 ea.
 4 oz. Flip-cap Tube **1008061** \$4.89 ea.
 15 oz. Jar **43033** \$15.99 ea.

UNIT DOSE

Foil Pack, 144's. **43143** \$21.79 box

Zinc Oxide

Used to treat or prevent minor skin irritations such as burns, cuts, and diaper rash.

1 oz. **43034** \$1.99 ea.
 1 lb. Jar **43035** \$10.69 ea.

POWDER

B. Johnson's® Baby Powder

Helps to eliminate friction while keeping skin cool and comfortable.

15 oz. **44117** \$7.39 ea.

Baby Powder

14 oz. **44244** \$4.19 ea.

SKIN PREP

C. Betadine® Surgical Scrub

Use for hand hygiene, surgical hand-scrubbing, and topical degerming of patient's skin.

4 oz. **34017** \$12.60 ea.
 32 oz. **34018** \$22.20 ea.

D. PDI® Alcohol Prep Pads (Sterile)

Contains 70% Isopropyl Alcohol. 2" x 1¼", 200/box . . . **49003** \$7.01 box

E. School Health Brand Sterile Alcohol Prep Pads

200/box **49251** \$3.27 box

F. Prep Shaver Kit

Kit includes: 1 Double Edge Razor (90944) and 2-4" x 4" Sterile Gauze Pads (27015).

50/box **90945** \$34.25 box

Alcohol

Use for simple wound disinfections.

Ethyl (70%)

16 oz. **34040** \$3.22 ea.

Isopropyl (70%)

2 oz. Spray **1005951** \$3.21 ea.

16 oz. **34042** \$2.21 ea.

32 oz. **34147** \$4.54 ea.

Isopropyl (99%)

16 oz. **34237** \$3.07 ea.

Razor, Double Edge

. **90944** \$0.13 ea.

SKIN ADHESIVE & PROTECTANT

G. Histoacryl® Topical Skin Adhesive

The proven choice for wound closure.

Clear. **49139** \$55.00 ea.

H. New-Skin® Liquid Bandage

Dries rapidly to form a breathable, tough protective cover that is antiseptic, flexible and waterproof.

1 oz. Liquid **34226** \$9.74 ea.

1 oz. Spray **50081** \$9.74 ea.

I. Medique® Liquid Skin® Bandage Alternative

A 100% waterproof bandage that stays on hard-to-cover areas! Easy-to-apply, sting-free liquid bandage forms a breathable, protective layer that promotes healing and helps prevent infection by reducing exposure to dirt and germs.

0.5 g, 10/Box. **1006096** \$16.80 box

Bandage Spray

Not recommended for children.

3 oz. **50002** \$6.10 ea.

SUNSCREEN

A. Coppertone Sunscreen

- Provides protection from UVA rays that may contribute to skin damage and premature aging of the skin
- Higher SPF gives more sunburn protection
- Retains SPF after 80 minutes of activity in the water or sweating

Lotion, 8 oz. Bottle

SPF 15..... **1034306** \$16.95 ea.

Sport Spray 5.5 oz Can

SPF 15..... **1034309** \$16.90 ea.

SPF 30 **1034308** \$16.90 ea.

SPF 50..... **1034307** \$16.90 ea.

Ultra Guard Lotion, 8 oz. Bottle,

SPF 30 **1034311** \$16.95 ea.

SPF 50..... **1034310** \$16.95 ea.

WART REMOVAL

Wart Treatment

Mediplast, 2" x 3"

25/box **29061** \$56.60 box

WOUND PROTECTANT

Benzoin Tincture Ampules

Can be used to adhere to athletic tape and bandages. May also be applied as an antiseptic to small cuts and to skin as a protective dressing under protective bandages. 100 ampules per box.

100/box **49061** \$46.55 box

WOUND WASH

D. AmeriGel® Wound Wash

Saline is a water-based solution containing sodium chloride, an essential salt required by the human body, that is hospital-grade in quality. Free from contamination, bacteria and other potentially harmful chemicals found in normal tap water.

4 oz. **34597** \$12.85 ea.

7.1 oz. **34598** \$18.90 ea.

E. Biomed Wash®

A sterile, heavy mist with an all-natural and pH correct grade of water.

- Emergency first aid eye wash and irrigation
- Washes contaminants from cuts and lacerations
- Helps remove irritating chemicals from eyes and skin

3 oz **34648** \$8.68 ea.

7 oz **34649** \$14.45 ea.

F. Cramer® Cinder Suds Spray

Cleans the dirt and debris from new and open wounds and skin abrasions.

5 oz..... **50008** \$11.75 ea.

B. Sun X Broad Spectrum Sunscreen

- SPF 30+
- FDA compliant with new 2012 FDA Sunscreen Monograph
- Aloe Vera Gel & Vitamin E, with UVA/UVB protection,
- Passed the Lineman's Glove Test (Type 1 Class 2 ANSI/ASTM D 120)
- FDA rated Water & Sweat Resistant with max allowed duration time (80 minutes)
- PABA Free & Oil Free

1 Gallon **43401** \$183.00 ea.

16 oz **43402** \$23.30 ea.

UNIT DOSE

Pouches, 25/pkg.

..... **49065** \$21.80 pkg.

TAPE REMOVER

C. PDI® Adhesive Tape Remover Pads

Effectively removes tape and residue from skin.

100/box **49006** \$7.27 box



A



B

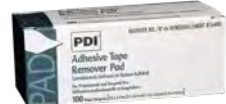

C



D



E



F



G



H

G. SalJet®

Single-use saline.

UNIT DOSE

1 oz., 40/box..... **34367** \$60.85 box

H. Skintegrity® Wound Cleanser Spray

- For cleansing of wounds in all stages
- Post surgery care
- Safe for all wounds

16 oz..... **50172** \$14.30 ea.

Sterile Water

A smaller portion of irrigating solution in a plastic bottle.

500 mL. **42056** \$8.00 ea.

Medication Supplies & Syringes

MEDICATION SUPPLIES



Pill Envelopes

Heavyweight, white imprinted envelopes. Ample room for patient information.

3½"x 2¼", 1,000/box **90018** \$28.35 box



Pill Splitter/Crusher

No more crushing pills with a spoon! Stainless steel blade easily splits or crushes pills. Bottom can be used as a drinking cup.

..... **90564** \$7.86 ea.

Pill Counter **91531** \$12.00 ea.

Pill Cutter **90178** \$7.58 ea.

Pill Crusher **90073** \$7.58 ea.

Dosage Measurements

Syringe **90401** \$1.73 ea.

Dropper **90403** \$1.73 ea.

Spoon **90402** \$1.73 ea.



Two pack!



Pill Pod & Box Value Pack

Contains 1 daily pill pod, plus one daily pill box. Round pill pod (one compartment) and kidney shaped pill box (three compartments).

..... **90583** \$3.14 pkg.



SafetySack Medication Pouch

Clear pouch designed to hold medication; features a child-resistant safety lock and re-closable slide zipper. Choose from two Emergency Action Plan cards that include: information on the child—picture, name and specific condition; list of symptoms to watch for and treatment; list of medications in SafetySack, along with expiration dates; and list of emergency contacts.

EpiPen **61702** \$13.90 ea.

Blank **61704** \$13.90 ea.

Needle Disintegrator

The Disintegrator is a portable, easy-to-use device that allows for safe disposal of used syringes by disintegrating the needle, eliminating the need to transport and store hazardous sharps. Destroys needle leaving no ash, residue or smoke. The rechargeable battery will disintegrate over 40 needles between charges. Includes inserts for ¾ cc, ½ cc and 1 cc syringes. TB syringe insert and ½-1½ blunting adapter are sold separately. FDA Class III approval. EPA and ADA-recommended.

..... **90692** \$118.00 ea.

SYRINGES



A



B



C



D



E



F



G

B-D® 3 cc Syringe Detachable Needle

LUER-LOK tip — secures needle tightly to syringe. Strengthened for tighter attachment.

25g

⅝", 100/box **90222** \$30.30 box

23g

1", 100/box **90223** \$30.30 box

B-D® Precision Glide® Needle

The sharpest needle available. Designed for greater patient comfort. Detachable needle slip tip.

1 cc Tuberculin Syringe, 25G

A. ⅝", 100/box **90224** \$37.70 box

Needle, 26g x ½", Regular Bevel, Sterile

B. 100/box **91352** \$15.90 box

BD Insulin Syringes

½ mL Lo Dose 31GA

C. ⅝", 100/box.. **1034287** \$60.30 box

B-D® 3ML/CC Syringe

LUER-LOK tip — secures needle tightly to syringe for a strengthened, tighter attachment.

22G

1", 100/box **91236** \$30.30 box

B-D® Filter Precision Glide Needle

To be used with epinephrine ampoules item (90719). needle, 18g x 1½" thin wall, blunt fill tip, 5 micron, contains no natural rubber latex.

D. 100/box **91351** \$67.65 box

B-D® 1 ML Syringe, Syringe Only

To be used in coordination with item (91351) for the administration of epinephrine ampoules item (90719).

E. 1mL, 100/box.... **91353** \$72.15 box

B-D® Catheter Tip Syringe, Tip Shield

For general use and can be used with tube feeding instruments.

F. 2 oz., 40/box. **36282** \$75.90 box

B-D® Safety-Lok Syringes

The sliding sleeve covers the needle when not in use and helps protect against accidents. Includes needles and a Visual Lock Indicator that confirms locking of the sliding sleeve.

3 cc Syringe, 25g

Syringe with Needle, 1cc, ⅝", 25mg

100/box **91489** \$71.15 box

G. BD SafetyGlide™ Shielding Hypodermic Needle

Makes a safe injection easier and more efficient.

23g, 1 inch, 2 mL, 50/box

..... **1035133** \$21.99 box

Value Priced Syringes with Needles

1 cc Tuberculin LUER-SLIP, 25G

⅝", 100/box. **90225** \$21.80 box

3 cc Syringe LUER-LOK, 25G

⅝", 100/box. **90226** \$16.90 box

3 cc Syringe LUER-LOK, 23G

1", 100/box **90227** \$16.90 box

60 cc Syringe LUER-LOK

40/box **90724** \$62.50 box

Topical Analgesics & Muscle Care



Prossage Heat

Designed to produce gentle penetrating heat to soft tissue structures. By applying palmer friction techniques, access to deep painful connective tissue adhesions can be faster, more effective, and pain free.

3 oz..... 34365 \$13.99 ea.



Biofreeze Pro Cryotherapy Pain Relief

Biofreeze Professional effectively alleviates pain from backaches, arthritis, sore muscles and joints, sprains, strains, and bruises. Our best topical pain relieving gel featuring what people love about Biofreeze with longer-lasting results. Our proprietary formula is made with U.S. Pharmacopeia-grade ingredients. This dye-free formula is free of parabens and propylene glycol. Proprietary formula made with USP-grade ingredients.

UNIT DOSE

5 g. Packet, 100/box.....	43241	\$46.80 box
3 oz. Roll-On.....	43163	\$11.55 ea.
4 oz. Tube.....	43096	\$11.55 ea.
4 oz., Spray Bottle.....	43424	\$15.10 ea.
Pump Bottle		
16 oz.....	43065	\$41.75 ea.
32 oz.	43066	\$55.25 ea.
Gallon.....	43067	\$168.00 ea.



[pH]UEL

[pH]UEL topical formula is designed to support the low pH environment needed to promote optimal muscle performance and recovery.

8 oz Spray	1031149	\$17.15 ea.
8 oz Spray, 12/cs	1031120	\$205.79 cs.
8 oz Foam.....	1031150	\$17.15 ea.
8 oz Foam, 12/cs	1031121	\$205.79 cs.
4 oz Foam.....	1031148	\$8.58 ea.
4 oz Foam, 12/cs	1031119	\$102.99 cs.



Flexall 454®

The largest-selling product among external analgesics. Penetrating relief from pain and stiffness of muscles and joints. Use with ultrasound, soft tissue massage, ice, breathable wraps and between TENS treatments. Aloe vera-based, absorbs quickly, is greaseless and non-staining.

Regular Strength

4 oz.....	43117	\$12.60 ea.
16 oz.....	43118	\$24.95 ea.
7 lbs.....	43119	\$125.50 ea.

Maximum Strength

3 oz.....	43149	\$10.99 ea.
16 oz.....	43150	\$28.99 ea.
7 lbs.....	43151	\$145.99 ea.



Tiger Balm®

Red, 18 gm., X-Strength..... 43212 \$10.99 ea.

Topical Analgesics & Muscle Care



Point Relief LidoSpot Pain Patch

Point Relief LidoSpot pain relieving patches provide long-lasting pain relief. Each patch contains the highest permissible amount of lidocaine (4%) without a prescription, and 1% menthol. The patch is large enough to fit areas such as the thigh, and can be cut to fit small, hard to fit areas such as the wrist or elbow. Use a LidoSpot patch after a pain treatment regimen to provide relief up to 12 hours.

Dimensions: 7.25" x .5" x 8.5"

- 20/pk.**1007488** \$97.99 pkg.
- 5/pk.**1007489** \$24.99 pkg.



Mueller® Coolant Spray

Non-medicated spray to cool skin fast and help relieve swelling.

- 3.5 oz **50126** \$6.99 ea.
- 9 oz **50127** \$10.99 ea.

FREE SHIPPING at SchoolHealth.com/SportsMed

Get FREE SHIPPING on your online order over \$100! Go to the back cover for Free Ship Online code. Can only be used once per customer. Expires 12-31-20.



Bruise-Strain-Tear Repair Gel

WADA and NCAA compliant water based transdermal gel of numerous herbs and roots that have used to heal for centuries. This is 100% conductive and it can be used with Ultra sound to imbed the active ingredients.

- 6.8 oz**1003614** \$16.99 ea.
- ½ Gallon.....**1003613** \$104.99 ea.
- Gallon**1003612** \$189.99 ea.

Muscle Honey Sports Gel

Performance Power of all of these natural constituents combined into one easy to apply gel. An all-natural WADA & NCAA compliant performance gel that is easily absorbed into tissue. It has been found to reduce cramping and muscle twitching.

- 6.8 oz**1003617** \$16.99 ea.
- ½ Gallon.....**1003616** \$104.99 ea.
- Gallon**1003615** \$189.99 ea.



Cramer® Cramergesic

Mild Warmth

- 1 lb. **43079** \$16.99 ea.
- 5 lbs. **43080** \$83.99 ea.

Cramer® Atomic Balm

Moderate penetrating warmth.

- 2.75 oz. Tube..... **43072** \$8.99 ea.
- 1 lb .. **43073** \$16.99 ea.
- 5 lbs. **43074** \$79.99 ea.

Cramer® Red Hot®

Strong penetrating warmth.

- 2.75 oz. Tube..... **43085** \$10.99 ea.
- 1 lb. **43086** \$16.99 ea.

Cramer® Cold Spray

Topical coolant that evaporates from the athlete's skin, lowering the surface temperature. Non-staining.

- 6 oz..... **50010** \$13.99 ea.
- 10 oz..... **50202** \$19.99 ea.



A

A. Suture Removal Kit

Contains a pair of ligature scissors, forceps and a gauze sponge.

..... **90135** \$3.83 kit

B. Laceration Tray (Suture Kit)

Contents:

- | | | |
|-------------------------|-----------------------------|----------------------------------|
| (2) Absorbent Towels | (1) 27 g x 11/2 Needle | (1) Adson Forceps, 1 x 2 Teeth |
| (1) Tray | (5) Gauze Sponges, 2" x 2" | (1) Mosquito Forceps, curved |
| (1) Iris Scissors | (1) Webster Needle Holder | (1) Fenestrated Drape, 18" x 26" |
| (1) CSR Overwrap | (10) Gauze Sponges, 4" x 4" | |
| (2) 2 oz. Medicine Cups | | |
| (2) 18 g x 11/2 Needles | | |
| (1) 25 g x 5/8 Needle | | |

..... **90438** \$16.50 kit



A



B

A. Countertop Fold-Over Instrument Carrier

Conveniently organize and transport instruments. Features 3 fold out panels, 2 rows of 15 instrument sleeves and 1 row of mini sleeves for tweezers, etc., and inner sleeves for 3 1/2" to 10" instruments- including tape cutters. Fold-over design with flap closure easily fits in medical bags. Color: Black.

Overall (flat): 31 3/4" W x 11" L x 1/2" D, Closed: 10" W x 11" L x 1" D

..... **40150** \$124.99 ea.

B. Scissor Holster

Water repellent 1000D nylon lined with 8mm of cushioning foam. Lightweight for wearing comfort. Heavy nylon thread for durability and snap open belt loop reinforced with Velcro for added security. Bags come empty. Accommodates belts up to 2 1/2" wide.

Large measures 7 1/4" x 5" x 1/2". Weighs 2 oz., Small measures 7 1/4" x 2 3/4" x 1/2". Weighs 1 1/2 oz.

Large **36266** \$37.50 ea.

Small **36267** \$9.55 ea.



12/pkg..... **99295** \$13.34 pkg.

School Health Brand Sponges

Simply place in water, and our compressed cellulose sponges absorb liquid and swell to 5 1/2" x 2 3/4".

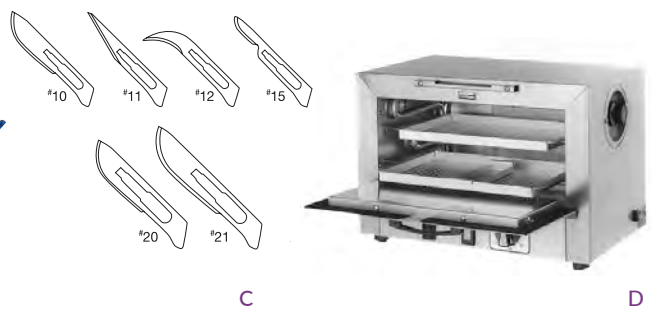

C

D

C. Disposable Scalpels

These single-use, sterile, disposable scalpels come in individual peel packs with visual blade identification. Scalpels come 10 per box and come with handle.

#10 36037	\$12.75 box	#15 36097	\$12.75 box
#11..... 36064	\$12.75 box	#20 36098	\$12.75 box
#12 36065	\$12.75 box	#21 36099	\$12.75 box

D. Dry Heat Sterilizer

Operates at 320°-360°F (160°-180°C) automatically. Simply place unsterile items in trays, and set timer. Plugs into 115V AC current.

Features:

- Precision thermostat, signal light, thermometer
- Rapid heat-up time with safety limit control
- Heating elements cannot burn out
- Two hour timer with "HOLD" position
- Glass wool insulation for minimum heat loss
- Meets all electrical standards. UL listed.
- FDA registered

15 1/2"W X 10 1/2"H X 9 1/2"D **90808** \$1,065.00 ea.

Nylon Self Seal Pouch (Not shown)

For use in high temperature dry heat to hold loose instruments. The material is clear and has a melt point of 420°F.

2" x 10", 100/box..... **36216** \$28.20 box

3" x 10", 100/box..... **36215** \$39.60 box

Dry Heat Chemical Indicators (Not shown)

For use as an external or internal monitor, these color change chemical indicator strips can be written on and kept as a permanent record.

100/box **36234** \$31.30 box



A



B

Tuning Forks

Made of die-cast aluminum alloy. Commonly used to detect fractures when x-rays are not available.

A. Economy, 256Hz..... **36122** \$7.99 ea.

B. Deluxe, C256 Fixed Weight..... **36121** \$17.25 ea.

Tape Scissors & Cutters



A. Raptor Medical Shears Leatherman

The fold up medical shears from Leatherman is constructed of high quality stainless steel. The sheers feature the necessary tools in a compact design, so medical professionals can respond quickly and efficiently. The Raptor folds up easily with built in clip and holster for convent storage and features: folding medical shears, tape and strap cutter, ring cutter, laceration ruler, oxygen tank wrench and carbide glass breaker.

Closed length: 5 in / 12.7 cm, weight: 5.8 oz. / 164 g, shear length: 1.9 in / 4.8 cm, TSA Compliant, 25-year Manufacturer Warranty.

.....1002858 \$80.95 ea.

B. Kinesiology Tape Scissors

Quickly and effortlessly cut through tape with this quality nylon cutter. Designed to cut tape against skin with no injury. It's lightweight and compact, comes ready to use.

.....1000114 \$37.99 ea.

C. Ripshears

A combination tool Ripshears will easily slice through multiple layers of athletic tape, clothing, shoes, belts, equipment straps, bandages, plastic packaging, and much more! Fully assembled surgical stainless steel shears with a black Titanium Carbo-Nitride (TiCN) coating. Includes detachable Ripshears Ripper (1007255).

7¼.....1007256 \$32.95 ea.

D. Ripshears Mini

5¼.....1007257 \$23.30 ea.

E. Ripshears Ripper

The Ripper unit will bolt onto most sets of standard 7 1/4" trauma shears turning them into a virtual a multidimensional tool! There will be no need to waste time digging through your bag to find the right tool because now you will have four tools, right in the palm of your hand.

.....1007255 \$21.35 ea.

F. Ripshears Holster (For 1007256 only)

.....1007258 \$35.15 ea.

Ripshears Blades

Fits only Ripshears (1007256) and Ripshears Ripper (1007255)

.....1007254 \$8.42 ea.

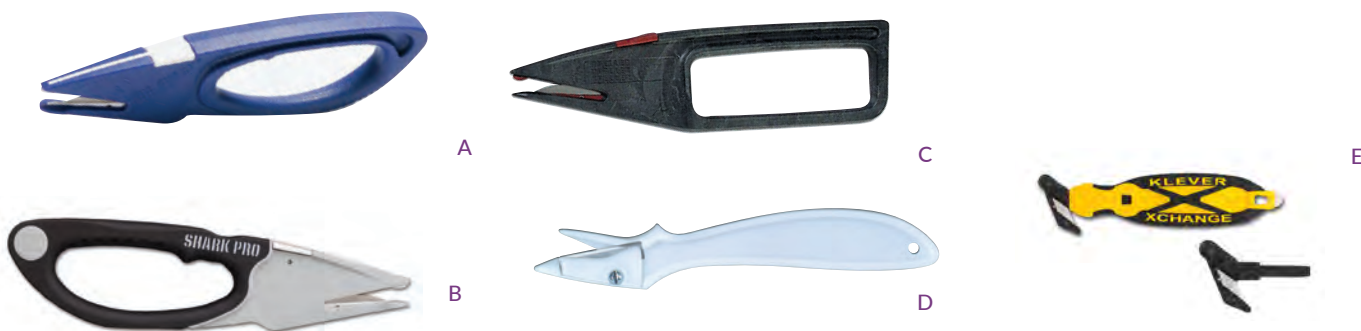

A. Shark Tape Cutter

Plastic Cutter 36006 \$14.65 ea.

Blade..... 36007 \$5.31 ea.

B. M-Cutter™ and Blades

Features snap-in stainless steel blade cartridge.

Plastic Cutter 36075 \$10.99 ea.

Blades, 10/pkg 36270 \$35.99 pkg.

C. Shark Pro Tape Cutter

Cutter 28477 \$20.99 ea.

Blade..... 36007 \$5.31 ea.

D. SH School Health Brand Tape Cutter

Plastic Cutter 36067 \$6.67 ea.

Blades, 20/pkg..... 36068 \$8.08 pkg.

E. Klever X-Change Tape Cutter

Economical tape cutter with exchangeable , titanium coated blades cuts tape easily. Interchangeable head design. Keep the handle, replace the blade!

.....1007234 \$9.76 ea.

Replacement Blade1007235 \$1.13 ea.

Scissors & Forceps



A. Lister Bandage Scissors

Stainless Steel		
4½"	36030	\$4.15 ea.
5½"	36031	\$5.01 ea.
7¼"	36032	\$7.60 ea.

Lister Double Ring Bandage Scissors

One Large Ring—Stainless Steel		
8¾" (Not shown)		
.....	36025	\$11.50 ea.

B. Knowles Bandage Scissors

Stainless Steel		
5½"	36034	\$6.39 ea.

C. Cuticle Scissors

Stainless Steel		
3½", Short Shank	36029	\$3.82 ea.

Operating Scissors

5½" Straight—Stainless Steel		
D. Sharp/Sharp Pts	36058	\$3.96 ea.
Sharp/Blunt Pts	36059	\$3.96 ea.
E. Blunt/Blunt Pts	36060	\$3.96 ea.

F. Super Pro Bandage Scissors

8½" Scissors—Stainless Steel		
.....	36074	\$49.80 ea.
G. 21 Right Handed	36120	\$49.80 ea.
H. 21L Left Handed	1006546	\$49.80 ea.
I. 11T Non-Stick	1006545	\$48.35 ea.
J. 21T Non-Stick	1006547	\$48.35 ea.

8¼" Original Clauss Bandage Shears

.....	36105	\$43.50 ea.
-------	-------	-------------

Cramer Heavy Duty Tape Scissors

.....	36073	\$18.25 ea.
-------	-------	-------------

K. Littauer Stitch Scissors

4½"	36288	\$4.58 ea.
-----	-------	------------

L. Heavy Duty Utility Scissors

5½", Black	36096	\$5.82 ea.
7¼", Black	36066	\$9.36 ea.
7¼", Blue	36106	\$9.36 ea.
7¼", Red	36107	\$9.36 ea.
7¼", Green	36108	\$9.36 ea.

M. Economy Bandage Scissors

Our most affordable bandage scissors yet.		
5½", Black	36180	\$4.62 ea.

N. Utility Forceps

8" Stainless Steel		
Straight		
.....	36056	\$7.35 ea.
Curved		
.....	36057	\$8.05 ea.

O. Halstead Mosquito Forceps

Straight-Box Lock—Stainless Steel		
5"	36038	\$5.64 ea.

P. Kelly Hemostatic Forceps

5½" Stainless Steel		
Straight		
.....	36053	\$5.36 ea.
Curved		
.....	36054	\$5.36 ea.

Specialty Instruments



A



B



C



D



E



F



G

A. Thumb Dressing Forceps

Stainless Steel

4½"	36040	\$2.92 ea.
5½"	36041	\$3.45 ea.
6"	36042	\$4.22 ea.

B. Feilchenfelds Splinter Forceps

Stainless Steel

3"	36044	\$3.51 ea.
4½"	36045	\$3.64 ea.

C. Carmalt Forceps-Offset

Stainless Steel

4¼"	36049	\$4.31 ea.
-----------	-------	------------

D. Fine Point Splinter Forceps

Stainless Steel

3½"	36046	\$2.84 ea.
4½"	36047	\$3.16 ea.

E. Magnifier Forceps

Stainless Steel

3½"	36048	\$13.85 ea.
-----------	-------	-------------

F. Tissue Forceps

1 x 2 Teeth, Stainless Steel

5½"	36055	\$3.40 ea.
-----------	-------	------------

G. Tweezers

Slant	36297	\$2.93 ea.
Square	36298	\$2.93 ea.
Blunt	36299	\$2.93 ea.



A



B



C



D



E



F



G



H



I



J

A. Becton Dickinson Ring Cutter

with 1 Saw Blade 36004 \$171.50 ea.

Replacement Blade
..... 36005 \$35.60 ea.

SH School Health Brand Ring Cutter (Not shown)

All metal.

Replacement blade is for ring cutter only.

with 1 Saw Blade. 36061 \$48.35 ea.

Replacement Blade
..... 36062 \$9.48 ea.

B. Percussion Hammer

Large 7½" solid chrome steel handle for sure grip and triangular shape solid rubber head.

..... 36072 \$6.01 ea.

C. Buck Neurological Hammer

..... 36113 \$10.10 ea.

D. Pedi-Corn Cutter

..... 36109 \$10.75 ea.

Blades, 10/pkg. 36110 \$5.07 pkg.

E. Fingernail Drill

Chrome-Plated with Three Drill Points

..... 36043 \$54.70 ea.

Replacement Drill Points

3/set 36102 \$26.80 set

F. Cuticle Nipper

Straight Spring, Concave Jaw – Chrome.

..... 36036 \$16.45 ea.

Nail Nipper (Not shown)

Concave Jaw, 4½" Barrel Spring.

..... 36035 \$19.05 ea.

G. Splinter Removers

Sterile, disposable stainless steel lancets for splinter removal. Individually wrapped.

10/pkg. 36123 \$2.44 pkg.

Skin Staple Remover- Sterile (Not shown)

..... 36271 \$3.22 ea.

Clippers

H. 2¼" Fingernail 36071 \$2.00 ea.

I. 3¾" Toenail 36070 \$3.55 ea.

J. Pedi-Shaper™ Form Foot File

Shapes calluses, restores and preserves natural curves of foot. 10" long.

..... 27101 \$8.99 ea.

Diagnostic & Screening

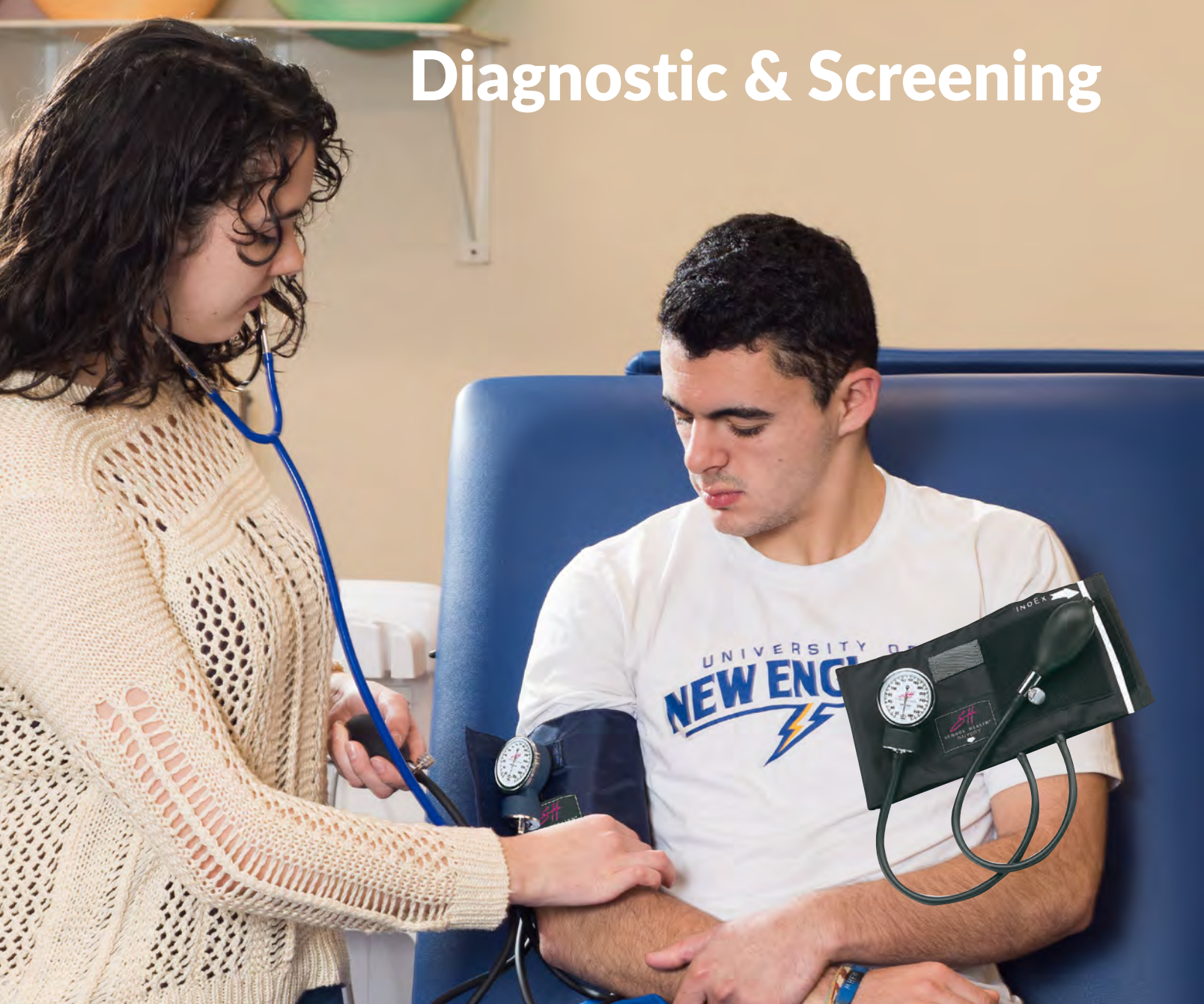

Thermometers	292-295	Nebulizer, Peak Flow Meter & Chambers	306
Blood Pressure Instruments	296-300	Diabetes Products	307
Pulse Oximetry	301	Lancets , Glucose & Injection Training	308
Stethoscopes	302	Scales	309-311
Penlights	303	Pedometer & Measuring Devices	312
Otoscopes & Diagnostic Sets	303-305		

Thermometers



Get 750 FREE probe covers when you purchase a Welch Allyn® SureTemp Plus Model 690!*



Welch Allyn® SureTemp® Plus Model 690

Features a removable probe well and an easy-to-hold and easy-to-operate design. The best electronic thermometer!

- 4–6 second oral and 10–13 second pediatric axillary temperatures.
 - Ergonomic design is comfortable to hold and very durable.
 - Runs on three “AA” batteries.
 - Easy-to-use, familiar technology.
 - Large LCD display has last temp recall.
 - Interchangeable/removable probe well, for easy cleaning.
 - 25 disposable probe covers can be conveniently stored inside the unit.
 - 2-year limited warranty on the thermometer; one year on the probe.
- **13071** \$311.50 ea.

Accessories

A. Disposable Probe Covers

Fits all SureTemp® thermometers.

- 250/box **21431**
- 4 Boxes/case..... **21394**

Buy a case and SAVE!

- \$12.65 box
- \$48.45 cs.

B. Oral Probe Only for 690

..... **13073**

\$96.50 ea.

C. Rectal Probe Only for 690

..... **13074**

\$96.50 ea.

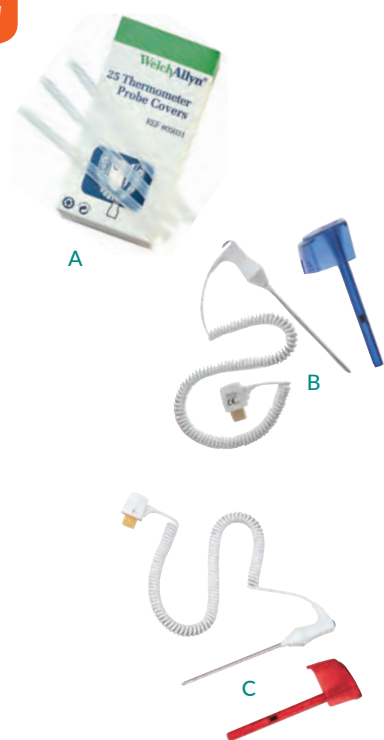

Partners in Care Services
SUPPORT | EDUCATION | PROFESSIONAL

SureTemp Comprehensive Partner Program*
1 Year **80115** \$42.00 ea.
2 Year **80116** \$84.00 ea.
Go to schoolhealth.com/partners-in-care

*Offer available for non-discounted product only.



Hillrom™

KEEP YOUR STUDENTS COMFORTABLE

The Welch Allyn® Braun ThermoScan® PRO 6000 ear thermometer supports quick and accurate temperature readings.

- Capture readings in about three seconds with disposable probe covers to help you minimize cross-contamination risk
- PerfectTemp™ technology helps to overcome the challenges presented by ear canal anatomy and variability in probe placement



Clinical studies have shown that the ear is an excellent site for capturing accurate measurements as temperatures taken in the ear reflect the body's core temperature¹

¹Guyton A C, Textbook of medical physiology, W.B. Saunders, Philadelphia, 1996, p 919

Thermometers

Welch Allyn® Braun ThermoScan PRO 6000 Ear Thermometer

The Braun PRO 6000 has a number of new features and functions that make it a true evolution in ear thermometer technology. The Braun ThermoScan PRO 6000 Ear Thermometer has the speed and simplicity you need for accurate, reliable temperature readings.

- The ergonomic handle design make this device comfortable to hold and operate
- Audible and visual cues guide the operator through proper use
- PerfecTemp improves accuracy by detecting direction and depth of probe placement in ear and adjusts temperature calculation
- ExacTemp helps support reliability and accuracy by detecting the stability of probe placement during measurement
- 60-second pulse timer assists with manual measurement of pulse rate and respirations
- Warranty: 3 years (Thermometer, Charging Station and Rechargeable Battery Pack)
- Two cradles offer storage of probe cover boxes, and pop up for easy probe cover attachment
- The large cradle can be wall mounted for added security when used with an optional security tether

SPECIAL OFFER!

Buy PRO 6000 (1005929 or 1005930) and get 800 Probe Covers Free!*



Braun PRO 6000

- A.** with Small Cradle **1005929** \$262.50 ea.
- B.** with Large Cradle **1005930** \$283.50 ea.

Probe Covers

The new probe cover features a flange design that prevents unauthorized covers from operating on the device.

- C.** 200/box. **1005927** \$21.75 box

PRO 6000 & PRO 4000 Probe Covers are not interchangeable

*Offer available for non-discounted product only.

Battery and Charging Station

Has storage for 200 probe covers (not included), includes rechargeable battery pack.

- D.** Charging Station **1005928** \$159.50 ea.
- E.** Rechargeable Battery Pack **1005931** \$34.90 ea.

Optional Security Tether

Keeps thermometer attached to the cradle, to minimize loss and theft.

- F.** Tether with 6' Cord **1005932** \$35.85 ea.
- G.** Tether with 9' Cord **1005933** \$60.30 ea.

DataTherm II Continuous Temperature Monitor

Incorporate the DataTherm II Continuous Temperature Monitor for accurate and effective core body temperature assessment in your prevention and treatment of Exertional Heat Illness.

Data Therm II Kit/78 Inch, 2 Meter Probes

- **13119** \$429.00 ea.
- 2 Meter Replacement Temperature Probes, 5/bag
- **13121** \$187.50 pkg.



**Accurate Reading
in 30 Seconds!**



School Health Brand Digital Thermometer

Features 30-second readout. Unit beeps when maximum temperature is reached. Memory recall of last reading. Auto-Off. 1-year limited warranty. Fever Alarm.

.....	13101	\$8.64 ea.
School Health Brand Thermometer Sheaths		
100/box	21289	\$3.94 box
Replacement Battery.....	1003723	\$2.41 ea.

**Eliminates the
need for probe
covers and
reduces the
risk of cross-
contamination**



School Health Brand No-Touch Forehead Thermometer

This design eliminates the need for probe covers and reduces the risk of cross-contamination. Automatically powers off if left idle for 15 seconds. An easy to read LCD with backlight and color indication alarm. Temperature mode button to switch between Human and surface modes. The auto-sense function measures within 2-3 cm. Infrared, digital and 1-year warranty.

5.98"L x 2.76"W x 1.38"H	1030386	\$49.98 ea.
--------------------------------	----------------	-------------



Digital Thermometer with Flexible Soft Tip

A fast, 60-second readout is clinical accuracy to 2/10ths of a degree and a rubber side grips for easy handling. It features a fever alarm sounds for temperatures above 99.5°F, peak temperature tone, memory recall of last reading and auto shut-off.

.....	13054	\$12.40 ea.
Replacement Battery.....	1003723	\$2.41 ea.



Filac™ 3000EZ Thermometer

Gives fast accurate readings within 6 seconds on oral mode. It is self-calibrating and comes with an anti-theft system. The patented isolation chamber design and color schemes, along with the durable probe covers help minimize the chance of cross-contamination and enhance infection control measures. Operates on 4 "AA" batteries for 6,000 measurements.

Blue.....	13107	\$303.00 ea.
Blue Oral Probe Only	13104	\$111.50 ea.
Red Rectal Probe Only	13105	\$91.05 ea.
Filac™ 3000EZ Probe Covers		
500/box	13106	\$28.95 box



Mercury Free Thermometer with Plastic Case

A clinical thermometer that functions without mercury (non-toxic and safe for the user and the environment) or batteries. Easy-to-read and large enough to handle comfortably.

.....	13056	\$11.10 ea.
Sheaths, 100/box.....	21683	\$8.35 box

Glass Thermometer Sheaths (Not shown)

The original thermometer sheath with optional tear-tab. Sterile. (Formerly known as Sani-Therm™).

100/box	21048	\$5.92 box
500/box	21222	\$29.35 box



NexTemp Single-Use Thermometer

Meets ASTM accuracy requirements. Easy-to-use, contrasting color pattern and "embossed" dots enhance visibility. Convenient and versatile for oral and axillary. Non-sterile.

Individually Wrapped, 100/box	13052	\$19.30 box
Bulk-Packed, 250/box.....	13053	\$37.70 box

 Not made with Natural Rubber Latex.

Blood Pressure Instruments



SH School Health Brand Deluxe Professional Sphygmomanometers

Comfortable-fitting calibrated nylon cuff. 300 mmHg manometer accurate to ± 3 mmHg. Deluxe air release valve. Zippered carrying case. Lifetime calibration warranty. 5-year warranty on inflation system.

with Child Cuff	56120	\$47.80 ea.
with Adult Cuff	56121	\$47.80 ea.
with Large Adult Cuff	56122	\$53.15 ea.



SH School Health Brand Diagnostic Combo Kit

The School Health Brand Diagnostic Combo Kit includes a nylon carry case with our Sprague Rappaport-Type Stethoscope and accessory pouch, Aneroid Sphygmomanometer, Adult Cuff (10.98"–16.92") and a lifetime calibration warranty.

.	57110	\$63.05 ea.
-----------	--------------	-------------

SH School Health Brand Vital Statistics Kits

Accurate and reliable diagnostic products in one convenient kit. This package is the perfect tool to track your students' health with products you trust. Includes: School Health Brand combination aneroid sphygmomanometer with sprague rappaport-type stethoscope and durable Nonin pulse oximeter.

Kit 1 w/Blue Nonin Pulse Oximeter	53285	\$264.00 kit
Kit 2 w/Red Nonin Pulse Oximeter	53286	\$264.00 kit
Kit 3 w/Black Nonin Pulse Oximeter	53287	\$264.00 kit
Kit 4 w/Purple Nonin Pulse Oximeter	53288	\$264.00 kit



A

Welch Allyn® Platinum Series with DuraShock

Welch Allyn® Tycos DS58 Hand Aneroid Sphygmomanometer with DuraShock Gear Free, Super Shock Resistant Technology; Jewel Movement, Laser Engraved Dial, Lifetime Calibration Warranty; Zipper Case; Size-11 Adult, Reusable (Two Piece), 1-Tube Cuff.

Not made with Natural Rubber Latex.



B

A. DS58 Hand Aneroid

Features an ergonomic inflation bulb designed to enhance comfort while inflating the cuff. Includes gauge with adult cuff and nylon zipper case.

(DS58-11CB)	56129	\$317.00 ea.
-----------------------	--------------	--------------

B. DS48 Pocket Aneroid

Lightweight. Will not weigh down cuff on a patient's arm. Includes gauge with adult cuff and nylon zipper case.

(DS48-11CB)	56130	\$336.50 ea.
-----------------------	--------------	--------------

Welch Allyn® DuraShock Sphygmomanometers

This integrated-style gauge features a FlexiPort cuff-mounted design that's compact and lightweight. In use, the gauge can be rotated to any orientation desired by the clinician. With gear-free DuraShock™ technology, you can count on the integrated Aneroid to remain in calibration longer than traditional aneroids, providing more accurate readings over time and a lower lifetime cost. Unsurpassed reliability with a unique integrated, cuff-mounted design and certified accuracy to +/- 3 mmHg. Gauge snaps directly into cuff for quick cuff changes.

A. DS44 Gauge

Gray Bulb, Standard Valve, Changeable Bumper, Preprinted Dual-Face, 5 year warranty, Case optional.

with Adult Cuff.....	53100	\$84.20 ea.
with Child Cuff.....	53101	\$85.20 ea.

Accessories

Nylon Zipper Case.....	56218	\$28.65 ea.
------------------------	--------------	-------------

B. DS45 Gauge

Black Bulb, Tyco's Long-life Valve, Permanent Bumper, Laser Engraved Dual-Face, 10 year warranty, Case optional.

with Adult Cuff.....	56115	\$129.00 ea.
----------------------	--------------	--------------

Accessories

Nylon Zipper Case.....	56218	\$28.65 ea.
------------------------	--------------	-------------



Welch Allyn® Blood Pressure Cuffs Accessories

C. FlexiPort 1.....	56279	\$2.94 ea.
FlexiPort 2.....	56280	\$2.94 ea.
D. BP Port Fitting 1 Tube Screw Adapter.....	56322	\$8.86 ea.
BP Port Fitting 2 Tube Screw Adapter.....	56324	\$8.86 ea.
BP Port Fitting 2 Tube Locking Adapter.....	56325	\$8.86 ea.



Welch Allyn® Diagnostic Cardiology Suite (DCS) and Welch Allyn® Diagnostic Cardiology Suite with Spirometry

The Welch Allyn® Diagnostic Cardiology Suite ECG is a PC-Based resting ECG that provides a simple and secure ECG capture experience, designed with your workflow in mind. Now with optional Spirometry, you can collect ECG and spirometry data in a single device that fits into your clinical workflow.

- Wireless ECG connection with the Wireless Acquisition Module
- Captures best 10 seconds of ECG data, reducing the need for repeat tests
- Save PDF's to any network folder
- Complies with ACC, AHA and HRS recommendations for adult and pediatric patients

Optional Spirometry features:

- Fast, reliable pre-/post-bronchodilator FVC, SVC, and MVV testing
- Instantly verify quality and variability of test performance
- Single-use disposable transducers to help reduce the risk of cross-contamination

Electrodes ECG Resting Tab, 100/Box.....	54271	\$137.00 box
Patient Cable 10-Lead Resting ECG AHA	54272	\$593.00 ea.



Welch Allyn® FlexiPort Reusable BP Cuffs

Affordable and easy to use, FlexiPort Reusable Blood Pressure Cuffs offer all the advantages of FlexiPort technology—including simplified connectivity—in a dependable, durable design, time after time. FlexiPort technology enables every cuff to be used as a one- or two-tube cuff. Meets AAMI and AHA guidelines for proper fit and the cuffs are color-coded to make it easy to find the proper cuff size. Three-year warranty.

FlexiPort Reusable BP Cuffs w/o Tube

*Accessory for Welch Allyn® Connex ProBP

Small Child, 12–16 cm.....	56302	\$33.60 ea.
Child, 15–21 cm.....	56303	\$34.55 ea.
Small Adult, 20–26 cm.....	56304	\$36.50 ea.
Adult, 25–34 cm.....	56305	\$38.15 ea.
Large Adult, 32–43 cm.....	56306	\$42.60 ea.
Thigh, 40–55 cm.....	56307	\$66.40 ea.

Not made with Natural Rubber Latex.

Blood Pressure Instruments

NEW!



WelchAllyn®

Welch Allyn® Connex Spot Monitor and Stand

The device connects wirelessly to your EMR and accurately sends vitals to the patient chart from the point of care to help improve efficiency. It offers an upgradeable design and custom configurations including a choice of thermometry and/or pulse oximetry, connectivity and mounting/mobility options. In addition, the new Accessory Power Management Stand with WhisperDrive™ technology features additional power backup, providing up to 17 hours of on-time, alleviating the need to charge the monitor as frequently.

Features:

- Help improve accuracy and performance for neonate through adult patients
- Blood pressure averaging to help ensure accurate hypertension diagnosis
- Mobile stand option incl. work surface w/integrated battery for extended usage
- SureBP technology can provide BP in only 15-seconds—3X faster than competitors
- Connex Scoring App on-device calculator for custom protocols like NEWS, MEWS
- Partnerships with more than 90 leading EMRs including Epic and Cerner
- 2 Year Warranty

Monitor.....	1034457	\$2,400.00 ea.
Classic Stand.....	1034456	\$495.00 ea.



Welch Allyn® Connex® ProBP™ 3400 Digital Blood Pressure Device

Small enough to fit in your hand, with the same accuracy as Hillrom industry-leading vital signs devices, the Pro BP 3400 digital blood pressure device is a smart choice for clinicians in just about every medical setting. Ships standard with one Adult and one Large Adult Cuff. Ages 3 and up.

- Compatible with FlexiPort blood pressure cuff sizes ranging from small child (12 cm) to thigh (55 cm)
- Bluetooth® wireless and USB-wired technology enables connectivity to select EMR/HIS systems
- Lithium ion battery technology delivers 100 readings on a single charge with rapid recharge time
- AC adapter, 2-Year Mfg. Warranty

Hand-held Unit.....	.56270	\$759.00 ea.
Wall Unit.....	.56271	\$879.50 ea.
Mobile Unit.....	.56272	\$1,029.00 ea.

 Not made with Natural Rubber Latex.



ADView™ 2 Modular Diagnostic Station

A truly modular design allows you to create the diagnostic station that's perfectly suited to your needs, with up to three modules: blood pressure, temperature, and pulse oximetry. The ADView 2 easily captures automated blood pressure measurements at the touch of a button. Your choice of seven available cuff sizes, ranging from child to thigh, for use on patients ages three and older. Packaged in a contemporary, compact design with an easy-to-read LCD display and an integrated handle for portability.

Features:

- Clinical-grade Advantage™ BP technology from SunTech Medical®
- A proprietary manual BP mode, allowing measurement with a stethoscope using the auscultatory method
- A temperature module featuring Covidien Filac™ technology, providing accurate measurement in about 10 seconds. Module comes with standard oral/axillary probe
- ChipOx Nellcor™ SpO2 module, measures oxygen saturation of arterial blood flow in about 10 seconds. An optional pediatric/multi-site sensor is also available. Alternatively, choose the Masimo SET® SpO2 module upgrade
- Lithium ion power for longer battery life and lighter weight
- Optional accessories, including desk caddy or mobile stand, rectal probe and printer
- Three-year warranty on the blood pressure base unit, SpO2 module, and temperature module; two-year warranty on cuffs; 90-day warranty on all other accessories

ADVIEW2 Diagnostic Station with:

Blood Pressure/SpO2 Masimo Set/Temperature	1007349	\$3,095.00 ea.
Blood Pressure/SpO2 Masimo Set	1007348	\$2,196.00 ea.
Blood Pressure/SpO2 Nellcor/Temperature	1007350	\$2,381.00 ea.
Blood Pressure/SpO2 Nellcor	1007347	\$1,536.00 ea.
Blood Pressure/Temperature	1007351	\$1,660.00 ea.
Blood Pressure Only	1007346	\$897.50 ea.

Accessories:

Desk Caddy	1007352	\$56.35 ea.
Mobile Stand	1007353	\$363.00 ea.
Printer w/paper	1007354	\$787.50 ea.
Rectal Module	1007355	\$961.00 ea.
Probe Covers, 500/box	21273	\$29.30 ea.
Cuffs, 1 Tube w/Male Bayonet:		
Child, Green: (12-19cm) 4.7"-7.5"	1007345	\$16.20 ea.
Small Adult, Royal Blue: (17-25cm) 6.7"-9.8"	1007339	\$18.20 ea.
Adult, Navy: (23-33cm) 9.1"-13"	1007340	\$18.70 ea.
Adult Plus, Navy: (28-40cm) 11"-15.8"	1007341	\$21.25 ea.
Large Adult, Burgundy: (31-40cm) 12.2"-15.8"	1007342	\$23.60 ea.
Large Adult Plus, Burgundy: (40-55cm) 15.8"-21.7"	1007343	\$27.20 ea.
Thigh, Brown: (38-50cm) 15"-19.7"	1007344	\$27.20 ea.



Omron® BP 785 with Comfit

- Dual sensors automatically double check each reading
- Indicator confirms the cuff has been wrapped correctly on your arm
- The pre-formed arm cuff expands to fit both regular and large sized arms
- Two User Mode
- Automatically takes three consecutive readings one minute apart and displays the average
- AM/PM Averaging
- Irregular Heartbeat Detection
- BP Level Indicator
- AC Adapter
- 100 memory storage for each person
- 4 "AA" batteries not included
- 5-year warranty

.....**56274** \$156.00 ea.



Omron® 629 Compact Wrist Blood Pressure Monitor

Simple and portable design automatically displays the average of up to the last 3 readings taken within the last 10 minutes. 60 memory storage with date and time stamp. Fits wrists 5.25" – 8.5". Two "AAA" batteries included. 2 year warranty.

.....**56277** \$107.00 ea.

Blood Pressure Instruments



LifeSource UA-767 One Step Plus Memory Blood Pressure Monitor

- Simultaneous readout of systolic/diastolic pressure and pulse rate.
- Provides blood pressure and pulse rate measurements even when an irregular heartbeat occurs.
- Four week blood pressure logbook.
- 30 reading memory and averaging.
- AC adapter included.
- Lifetime warranty.

with Adult Cuff	56168	\$122.00 ea.
with Small Adult Cuff	56169	\$121.00 ea.
Adult Cuff Only	56171	\$28.00 ea.
Small Adult Cuff Only	56172	\$28.00 ea.
Large Adult Cuff Only	56173	\$33.50 ea.
AC Adapter Only	56174	\$24.75 ea.



LifeSource Extra Large Arm – Blood Pressure Monitor

This monitor equipped with Irregular Heartbeat Detection, and HeartWise Technology which measures blood pressure on deflation. With an extra-large display, large buttons for easy operation, 60 memory recall, Time and Date with Three Alarms, and an AC Power Adapter, this monitor offers speed and reliability.

.....**56190** \$225.50 ea.

LifeSource BP Cuff Sizing Information	
Size	Arm Circumference
Small Adult Cuff	6.3" to 9.4"
Adult Cuff	9.4" to 14.2"
Large Adult Cuff	14.2" to 17.7"



E-SPHYG 2™

Graphic back lit mercury-free LCD for easier reading; multi-function alpha-numeric LCD displays air pressure, deflation rate, systolic, diastolic pressure and pulse; manual mode allows practitioners to use the auscultatory method with any sized cuff. Automatic inflation to pre-set levels simplifies use. ECV (electronic control valve) controls deflation at one of three pre-established rates for optimum results. Auto mode obtains readings automatically in about 1 minute; automatic inflation and deflation. Select from deflation rates of 2.5, 4.5 or 6.5 mmHg/sec. NICAD rechargeable battery provides about 200 measurements use on a single charge.

- AC adapter.
- Safe; no mercury, clinically proven accuracy.

Desk Model with Adult Small, Adult Regular, and Large Adult Cuffs	56327	\$528.00 ea.
Wall Model with Adult Cuff	56220	\$433.00 ea.
Mobile Model with Adult Small, Adult Regular, and Large Adult Cuffs	56326	\$584.00 ea.
Child Cuff Only (1.48" - 10.71")	56222	\$27.25 ea.
Adult Cuff Only (10.28" - 16.1")	56223	\$22.85 ea.
Large Adult Cuff Only (13.5" - 20.04")	56224	\$37.95 ea.



LifeSource UB-521 Wrist Blood Pressure Monitor

State-of-the-art measurement technology to monitor blood pressure at the wrist with the push of a single button. This wrist monitor is smaller, lighter and more compact than other wrist monitors and is ideal for travel. The automatic memory keeps your last 90 blood pressure measurements for effective tracking. The UB-521 also has the Irregular Heartbeat feature. Fits wrists up to 8½". Operates on 2 "AAA" batteries (included). Lifetime warranty.

.....**56191** \$84.40 ea.

Not made with Natural Rubber Latex.



Nonin Onyx® Vantage 9590 Finger Pulse Oximeter

The Onyx Vantage 9590 finger pulse oximeter provides accurate data for actionable decision making.

- **Accurate** — Scientifically proven in the widest range of patient populations and settings. Including patients with low perfusion or dark skin tones
- **Durable** — Tough outer casing protects against dropping and water spills; allows for thousands of uses in demanding environments
- **Efficient** — Up to 6,000 spot checks or 36 hours of continual operation on two “AAA” batteries
- **Safe** — **Made in the USA** with lead-free construction
- **Versatile** — One unit works on a wide range of patients from pediatric to larger adults.
- **Warranted** — Industry leading 4-year warranty

Blue53237	\$194.50 ea.
Red53239	\$194.50 ea.
Black53238	\$194.50 ea.
Purple53240	\$194.50 ea.



NEW!

Medline High-Impact Finger Pulse Oximeter

The Medline High-Impact Finger Pulse Oximeter takes precise readings in seconds, as well as SpO2, pulse rate and pulse bar readings. It has a multi-directional display with full-color OLED screen and its durable silicone boot construction resists cracking and chipping. Has a hinged battery cover and includes “AAA” batteries, lanyard and warranty.

.....	1033997	\$89.25 ea.
-------	----------------	-------------

Nonin 8500 Handheld Pulse Oximeter

The 8500 handheld pulse oximeter provides an easy and accurate assessment of oxygen saturation and pulse rate from infants to adults. Truly portable, this pocket-size handheld oximeter will hold up in the most demanding environments. With 100 hours of battery life, the 8500 provides a cost-effective, environmentally friendly solution for your monitoring needs.

.....	53284	\$559.50 ea.
-------	--------------	--------------



SpO2 Finger Tip Pulse Oximeter

Features:

- Easy to Read OLED display
- Display SpO2, Pulse Rate
- Automatic power off & battery-low indicator
- Battery lasts approx. thirty hours
- 2 AAA alkaline or rechargeable batteries
- Ten adjustable brightness settings
- Wide range of fingers from pediatric to adult
- Two year warranty



.....	53249	\$73.40 ea.
-------	--------------	-------------



Pronto Hemoglobin Pulse Oximeters

Unlike traditional invasive lab testing, the Pronto hemoglobin pulse oximeters are noninvasive and quick spot checking devices that measure hemoglobin (SpHb), SpO2, pulse rate, and perfusion index.

Benefits:

- Facilitates timely patient assessment
- Decreases risk of accidental needle sticks and exposure to blood-borne pathogens
- Requires no lab consumables or waste disposal
- Enables immediate face-to-face counseling with clinician
- Easy-to-use—Improves efficiency

Pronto

Pronto Unit (No Sensors)	1005754	\$931.00 ea.
200 Adult Sensors*	1005693	\$734.50 ea.
Unit w/400 Adult Sensors*	53253	\$2,434.00 ea.

Not made with Natural Rubber Latex.

Stethoscopes

School Health Brand Stethoscopes

Trusted by Athletic Trainers
for over 10 years!



SH Single Head Stethoscope

School Health Brand Single Head, 22" Stethoscopes combine comfort, styling, sensitive acoustics and affordable pricing. These anodized aluminum stethoscopes are durable, lightweight and corrosion resistant. The adjustable binaural with gel ear tips provides a more comfortable and secure fit. Includes extra ear tips, diaphragm and a limited lifetime warranty.

Red	57105	\$9.99 ea.
Blue	57106	\$9.99 ea.
Black	57107	\$9.99 ea.
Green	57108	\$9.99 ea.

SH Dual Head Stethoscope

School Health Brand Dual Head, 22" Stethoscopes combine comfort, styling, sensitive acoustics and affordable pricing. These anodized aluminum stethoscopes are durable, lightweight and corrosion resistant. The adjustable binaural with gel ear tips provides a more comfortable and secure fit. Includes extra ear tips, diaphragm and a limited lifetime warranty.

Black	57097	\$14.10 ea.
Blue	57098	\$14.10 ea.
Green	57100	\$14.10 ea.
Magenta	57101	\$14.10 ea.
Teal	57102	\$14.10 ea.
Burgundy	57103	\$14.10 ea.

SH Sprague Rappaport-Type Stethoscope

School Health Brand Sprague Rappaport-Type, 22" Stethoscope features a sealed valve for improved acoustics and includes a chestpiece key for easier diaphragm changing. Our five-in-one, multi-purpose Quintscope comes with interchangeable chestpiece fittings, both adult and pediatric diaphragm, and 3 bells (1¼", 1", ¾"). These chrome-plated brass stethoscopes are durable, lightweight and corrosion resistant. The adjustable binaural with gel ear tips provides a comfortable and secure fit. Includes an accessory pouch with 3 bell chestpieces, 2 spare diaphragms, 1 chestpiece key, 1 pair of silicone ear tips and 1 pair of soft mushroom ear tips. Limited lifetime warranty.

Black	57092	\$17.55 ea.
Navy	57093	\$17.55 ea.
Magenta	57094	\$17.55 ea.
Blue	57095	\$17.55 ea.
Red	57096	\$17.55 ea.



A



B



C



D

A. 3M™ Littmann® Classic III™ Monitoring Stethoscope

This compact and sensitive stethoscope is the perfect instrument for clinicians who monitor and assess children or adults in non-critical environments. Manufactured with strong yet lightweight materials for hours of comfortable use.

Navy1031274	\$132.00 ea.
Caribbean Blue1031275	\$132.00 ea.
Burgundy1031276	\$132.00 ea.
Blue1031277	\$132.00 ea.
Lavender1031280	\$132.00 ea.
Turquoise1031281	\$132.00 ea.

B. 3M Lightweight II SE Stethoscope

Weighs less than 3 ounces. Made with anodized aluminum chest piece and ear tubes. Has the durability, comfort and acoustical features of more expensive stethoscopes. 20" long tubing.

Blue	57014	\$73.85 ea.
Burgundy	57045	\$73.85 ea.
Caribbean Blue1031269	\$73.85 ea.
Black1031268	\$73.85 ea.
Lilac1031270	\$73.85 ea.
Light Green1031271	\$73.85 ea.

C. Stainless Steel Stethoscope

All models feature a deluxe stainless steel chestpiece, 22" tubing and a stainless steel dual inner-spring binaural. Includes two extra sets of flexible eartips in two sizes and one extra diaphragm. Overall stethoscope length is 30". Lifetime limited warranty.

Blue	57114	\$38.30 ea.
Black	57115	\$38.30 ea.

D. Welch Allyn® Professional Stethoscopes

The Professional is one of the most comfortable and versatile general-use stethoscopes manufactured today. Its acoustics allow for accurate auscultation of cardiac, pulmonary, and vascular sounds. Constructed with a stainless steel double-head chest piece and custom-fitting headset and ear tip. 5 year warranty.

Black	57142	\$169.00 ea.
Burgundy	57143	\$169.00 ea.
Navy	57144	\$169.00 ea.

Not made with Natural Rubber Latex.

Penlights & Oscopes



Cobalt Blue Filter Penlight

- Diagnostic medical penlights with cobalt filters
- Designed for use with fluorescein dye
- Disposable version
- For use to detect retinal scratches

3/pkg.	1005772	\$17.10 ea.
Disposable Fluorescent Strips,100/box	44303	\$29.55 box



Reusable LED Penlights

Reusable LED Penlights with push button activation. 5x brighter than ordinary penlights. Made of lightweight aluminum. This is not designed to dilate the eyes. Operates on 1 "AAA" battery (included).

A. LED Bulb

Black	91326	\$9.46 ea.
Blue	91327	\$9.46 ea.
Silver	91328	\$9.46 ea.

B. Non-LED Bulb

Sliver	91306	\$5.75 ea.
--------------	--------------	------------



Disposable Penlights with Pupil Gauge

White, 6/box	90650	\$10.90 box
--------------------	--------------	-------------



Welch Allyn® Professional Penlight

Durable solid brass construction. Bright white halogen light. Two "AA" batteries included.

.....	90491	\$76.10 ea.
-------	--------------	-------------



MityLight®

Made of a high-impact, polycarbonate resin. Focused beam is 400% brighter than ordinary pocket lights. Complete with two "AAA" batteries. Length: 4 3/4", Diameter: 3/8".

Yellow	90213	\$19.50 ea.
--------------	--------------	-------------



Conventional Mini Oscopes

Perfect for nurses on the go, this mini otoscope conveniently fits in any nurse bag, purse or jacket pocket. Requires 2 "AA" Batteries and uses standard illumination (2.5 Volt Bulb). Ear specula available in 2.5mm, 3.0mm, 4.0mm and 5.0mm.

White	1003095	\$64.95 ea.
Black	1003096	\$64.95 ea.
Royal Blue	1003098	\$64.95 ea.
Pink	1003097	\$64.95 ea.

Accessories

Otoscope Specula, Black, Pack of 100

2.5mm	1003099	\$14.85 ea.
3.0mm	1003100	\$14.85 ea.
4.0mm	1003101	\$14.85 ea.
5.0mm	1003102	\$14.85 ea.
2.5V Replacement Bulb	1003103	\$18.75 ea.



ENT Pocket Light®

Bright xenon light. Pocket light can be detached for separate use. Lifetime guarantee.

Contents:

- (1) Plastic Case, (3) Adult Disposable Specula, (1) Adult Reusable Specula, (3) Pediatric Disposable Specula, (1) Pocket Light, (1) Otoscope Head, (2) "AAA" Batteries

Set in Black	53070	\$79.90 ea.
Set in Blue	53071	\$79.90 ea.
Reusable Specula, 10/pkg	53072	\$19.85 pkg.
2.75 mm Disposable Specula, Pediatric 34/tube.	53021	\$1.86 tb.
4.25 mm Disposable Specula, Regular 34/tube.	53022	\$1.86 tb.
4.25 mm KleenSpec Regular Speculum 850/bag	53170	\$40.50 bag
2.75 mm KleenSpec Pediatric Speculum 850/bag	53171	\$40.50 bag

Not made with Natural Rubber Latex.

Otoscopies



Choose between disposable or reusable ear specula.

Insufflation port for pneumatic otoscopy.

Adjustable focus can accommodate variable ear canal lengths and user's farsighted vision.

Advanced optics provide 2x the field of view and 30% greater magnification than a conventional otoscope.

The Welch Allyn® MacroView™ Otoscope

- Twice the field of view
- 30% greater magnification than a traditional otoscope

- Nearly a full view of the tympanic membrane
- 3.5 V Halogen Rechargeable

A. Complete Set with Throat Illuminator

(25270-M) **53127** \$462.50 ea.

Complete Set without Throat Illuminator

(25070-M) **53133** \$450.50 ea.

B. MacroView Head w/o Throat Illuminator

(23810-M) **53128** \$270.00 ea.

MacroView Head with Throat Illuminator

..... **53187** \$329.00 ea.

Insufflator (23804-M) **53129** \$14.85 ea.

Replacement Lamp

(06500-U) **53130** \$31.10 ea.

C. Upgrade LED Lamp Kit for Panoptic

(03800-LED) **53213** \$201.50 ea.

D. Upgrade LED Lamp Kit for Ophthalmoscope

(04900-LED) **53212** \$179.00 ea.

E. Upgrade LED Lamp Kit for MacroView

(06500-LED) **53211** \$146.50 ea.

F. Upgrade LED Lamp Kit for Otoscope

(03100-LED) **53209** \$146.50 ea.

G. NiCad Rechargeable 3.5 V Handle

Plug-in Handle **53091** \$227.50 ea.

Handle or Desk/Well **53290** \$185.00 ea.

Replacement Rechargeable Battery

(72200) Black ***53032** \$50.75 ea.

(72300) Orange ***53043** \$50.75 ea.

3.5 V Diagnostic Otoscope Replacement Accessories

(03100-U) Lamp **53025** \$29.35 ea.

(21504) Insufflator... **53047** \$14.55 ea.

H. 3.5 V Lithium Ion Smart Handle with USB Charging Module

Holds a charge for an average of 120 minutes. The lithium ion battery has no "memory" effect. Twice the power with a smaller diameter and half the weight of 3.5 V NiCad handles.

Handle with USB Charging Module

(71900) **53102** \$393.50 ea.

(71960) Battery ***53116** \$199.50 ea.



Welch Allyn® Digital MacroView

Offers clear, live, and still images of the ear canal and tympanic membrane. Easy to learn and use. Does not require additional purchase of software. Plug the otoscope into your computer using the USB cable, put on ear specula and turn on light, and view live picture or capture image.

Includes: Otoscope, 10 ft. USB cable and set of 4 reusable specula. Computer and handle not included.

..... **53173** \$1,410.00 ea.



Welch Allyn® Wall Diagnostic Center

Designed to put everything you need for fast, accurate diagnoses at arm's length in a convenient, modular package.

Complete Integrated Diagnostic Center

Includes heads and wall board. (Shown above).

..... **53131** \$1,903.00 ea.

A. Tycos® Wall Aneroid with Adult Cuff

(Lifetime calibration and manufacturing warranty).

(7670-01) **56086** \$303.50 ea.

B. 3.5 V Green Series 777 Wall Transformer

(Instrument heads not included).

(77710) **53251** \$689.50 ea.

C. Ophthalmoscope Head

(11720) **53075** \$345.00 ea.

D. MacroView™ Head Only

(23810) **53128** \$270.00 ea.

E. Kleenspec Plus® Dispenser

Features a large, 200-specula capacity and integral storage area. Dispense 524 Series (52432 and 52434) KleenSpec Disposable Specula. (Specula not included with dispenser).

(52401) **53076** \$56.50 ea.

F. SureTemp® Plus Model 767

(01690-300) **13069** \$363.00 ea.

All units with a MacroView™ Head receive a Free EENT Kit!



Otoscope/Ophthalmoscope Diagnostic Set

3.5 V Halogen Rechargeable MacroView and mirror optical ophthalmoscope. Includes rechargeable handle and four reusable specula in a zipper case.

Complete Set (Shown)

(97150-M) **53033** \$692.00 ea.

Ophthalmoscope Replacement Lamp

(03000-U) **53027** \$33.20 ea.

When ordering, please refer to the School Health® product numbers in bold print.

Numbers in parentheses are Welch Allyn® numbers.

* Note: When reordering batteries, please check Welch Allyn® number and color coding stamped on original battery.

Otosopes & Diagnostic Sets



A. Welch Allyn® 2.5 V Halogen Pocketscope

2.5 V Halogen converts to high intensity throat illuminator by removing otoscope head. Includes four reusable specula and two “AA” batteries. Zipper case not included.

Complete Set (Shown) (22820).....	53038	\$240.50 ea.
with Carrying Case (22821).....	53153	\$257.00 ea.

B. Otscope/Throat Rechargeable Set

Complete set with soft case, rechargeable battery, set of reusable specula and set of disposable specula, and desktop charger.

(22811).....	53039	\$592.00 set
--------------	--------------	--------------

Ophthalmoscope/Otscope/Throat Diagnostic Set (Not shown)

Pocketscope illuminator includes two “AA” batteries, set of four reusable specula and one tube of disposable specula in a hard case.

.....	53115	\$663.00 ea.
-------	--------------	--------------

Ophthalmoscope/Otscope/Throat with Desk Charger (Not shown)

2.5 V Halogen Rechargeable Pocketscope illuminator includes handles with rechargeable batteries, desk charger, four reusable specula and a tube of disposable specula in a hard case.

Complete Set with Charger (92850).....	53041	\$905.50 ea.
----------------------------------------	--------------	--------------

2.5 V Accessories and Replacement Parts

Otoscope Replacement Lamp (03400-U).....	53026	\$32.40 ea.
------------------------------------------	--------------	-------------

Ophthalmoscope Replacement Lamp (03900-U).....	53028	\$45.80 ea.
------------------------------------------------	--------------	-------------

(04400-U).....	53035	\$58.40 ea.
----------------	--------------	-------------

Upgrade LED Lamp Kit for Ophthalmoscope.....	53212	\$179.00 ea.
----------------------------------------------	--------------	--------------

Insufflator (21504).....	53047	\$14.55 ea.
--------------------------	--------------	-------------

Soft Zipper Case for 53038 (05928-U).....	53048	\$50.50 ea.
-------------------------------------------	--------------	-------------

Battery for 2.5 V Handle.....	53030	\$50.20 ea.
-------------------------------	--------------	-------------

(72000) Red.....	53030	\$50.20 ea.
------------------	--------------	-------------

(72600) Blue.....	53031	\$50.20 ea.
-------------------	--------------	-------------

Size “AA” Alkaline Batteries 2/pkg.....	90036	\$4.99 pkg.
-----------------------------------------	--------------	-------------

.....	53096	\$707.50 ea.
-------	--------------	--------------

C. Welch Allyn® PanOptic™ Ophthalmoscope

PanOptic™ provides a more panoramic view of the fundus than ever achieved with a standard ophthalmoscope in an undilated eye, so it’s easier to view small pupils.

- Illumination system converges the light to a point at the cornea, allowing easy entry into small undilated pupils
- Enables 25° field of view versus the standard 5° field of view and a 5x larger view of the fundus
- Increases magnification by 26% over a standard ophthalmoscope
- Works with all existing Hillrom 3.5 V power sources
- The patient eyecup establishes and maintains proper viewing distance, provides stabilization for the view
- PanOptic™ Ophthalmoscope Head
- 1 Eyecup and Halogen HPX lamp
- Corneal Viewing lens

.....	53096	\$707.50 ea.
-------	--------------	--------------

Welch Allyn® PanOptic™ Ophthalmoscope Accessories

Patient Eyecups 5/pkg.....	90455	\$35.15 pkg.
Halogen HPX Lamp.....	53094	\$56.60 ea.
3.5 V Rechargeable Handle Only.....	53091	\$227.50 ea.
Halogen HPX Lamp.....	53094	\$56.60 ea.
3.5 V Lithium Ion Smart Handle with USB Charging Module (71900-USB).....	53102	\$393.50 ea.
Carrying Case.....	53142	\$93.30 ea.

SPECULA & TIPS

Items D–H are compatible with the Diagnostic Otscope and the MacroView Otscope.

D. 524 Series KleenSpec® Disposable Specula

		<u>1–19 Tubes</u>	<u>20+ Tubes</u>
(52432-U) 2.75 mm Pediatric Speculum			
34/tube.....	53021	\$1.86 tb.	\$1.79 tb.
(52434-U) 4.25 mm Regular Speculum			
34/tube.....	53022	\$1.86 tb.	\$1.79 tb.
2.75 mm KleenSpec Pediatric Speculum			
850/bag.....	53170	\$40.50 bag	
4.25 mm KleenSpec Regular Speculum			
850/bag.....	53171	\$40.50 bag	

E. Wall Mounted Dispenser for 524 Series

Holds four tubes of the 524 Series specula.

(52400).....	53037	\$36.15 ea.
--------------	--------------	-------------

F. Reusable Polypropylene Diagnostic Otscope Specula

(24302-U) 2.5 mm.....	53161	\$4.40 ea.
(24303-U) 3.0 mm.....	53162	\$4.40 ea.
(24304-U) 4.0 mm.....	53163	\$4.40 ea.
(24305-U) 5.0 mm.....	53164	\$4.40 ea.

G. Welch Allyn® SofSeal® Disposable Tips

Equal to ²⁴³series (below) but disposable and can be used with all models-80/box

(24320-B) Small.....	53136	\$67.60 box
(24330-B) Medium.....	53135	\$67.60 box

H. 243 Series SofSpec® Soft Tip Reusable Specula

Improved seal for greater patient comfort. For Diagnostic Otsopes, not compatible with MacroView.

(24323) 3 mm.....	53015	\$17.90 ea.
(24325) 5 mm.....	53016	\$17.90 ea.
Nasal Speculum (24327) 7 mm.....	53017	\$17.90 ea.

Nebulizer, Peak Flow Meter & Chambers



Free Child Mask with purchase!

Vib-Mesh MINI Portable, Ultrasonic Nebulizer

This mini portable nebulizer's lightweight and petite size fits in one hand. It delivers timely relief, quickly and quietly with a single touch. Perfect at school or on the go. Includes: one mouthpiece, one mask adapter, one medication cup, one control unit, instruction manual, two "AA" alkaline batteries and a travel bag. Two-year warranty.

..... **1008072** \$70.20 ea.



Compressor Nebulizer

Delivers aerosol medication therapy effectively with clinical accuracy. Easy to use with one-button operation, and easy to clean. Ideal for all ages. Particle size range: 0.5 to 10 microns. Step-by-step instructions in English and Spanish. No water required to operate. 5-year limited warranty.

11 7/8" x 7 1/8" x 4 1/2", 4.6 lbs. **1031283** \$78.30 ea.

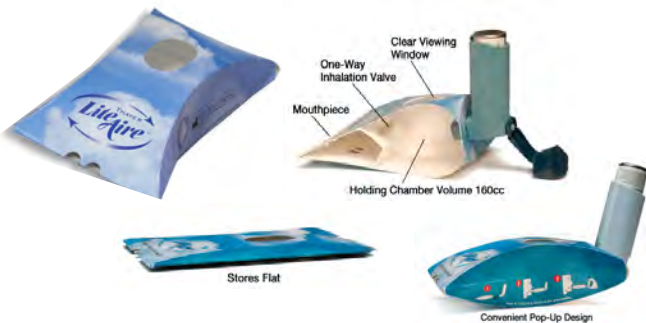

Lite Aire Disposable Spacers (Rx Item)*

Made from paperboard instead of plastic, this device provides the benefit of reduced cost and far greater portability. The Lite Aire disposable spacer makes using an inhaler much easier while improving medication dispersion.

25/box ***1002270** \$112.50 box



In-Check DIAL

The In-Check DIAL is a hand held inspiratory flow measurement device with a DIAL top. The DIAL orifices have been designed to simulate the resistance of inhaler devices from the DPI and MDI categories. The one-way valved mouthpiece protects both the DIAL and the next patient.

In-Check DIAL Kit

Kit Includes: In-Check DIAL, 200/bx inspiratory mouthpieces, peds/small adapter, informational CD, guide to implementation.

..... **1007898** \$330.50 kit
 In-Check DIAL G16 Trainer **1007897** \$147.50 ea.
 In-Check DIAL Mouth Piece, 10/bag **.61684** \$11.75 bag



Pocket Chamber™

Delivering effective relief from asthma symptoms. Fits virtually any metered dose inhaler. Anti-static chamber minimizes drug adherence to chamber wall. Whistle alert for excessive inspiratory rate. One-way silicone valve exhalation. More cost effective than nebulizer delivery.

..... **.61675** \$16.55 ea.

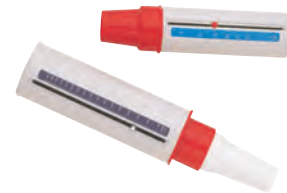

Mini-Wright Peak Flow Meter

Measures the openness of the airway by defining the amount of air that can be blown out of the lungs in a fast blast. This peak flow meter can detect changes in the airway at very early stages.

..... **.61062** \$47.35 ea.
 Adult Mouthpieces
 100/pkg **.61090** \$38.50 pkg.
 Pediatric Adapter **.61710** \$12.80 ea.
 Pediatric Mouthpieces
 100/pkg **.61711** \$38.65 pkg.

Safety One-Way Valve Mouthpieces

A safe way to use the Assess[®] Peak Flow Meter for multiple patients.

Child/Adult
 10/pkg **.61112** \$11.95 pkg.

*All prescription (Rx) purchases Requires Rx authorization form See "Medical Authorization Form" in the Index section.
 Please note: Epinephrine pens you receive have the best expiration date and price available at the time of purchase. Call Customer Care at 866-323-5465 with any questions.

Harmony Blood Glucose Monitoring System

- The meter accepts venous whole blood or capillary whole blood drawn from patient's fingertips, palm or forearm to provide fast results in eight seconds
- Only a small sample size of 0.8 microliters is needed, so there is less patient discomfort associated with the needle stick and blood draw
- A test strip ejector located on the side of meter allows you to dispose of used strips directly into the trash
- This eliminates your contact with used strips to help reduce the risk of cross contamination
- The wide hematocrit range of 10% to 70% allows you to care for higher acuity patients

Meter System	1035185	\$33.99 ea.
Test Strips, 50/box.....	1035186	\$18.50 box
Hi-Lo Control Solution	1035187	\$10.99 ea.



EVENCARE Pro View Blood Glucose Monitoring System

- The blood glucose meter provides simple and accurate diabetes management
- Large backlit display can be clearly read in low light
- Test strip ejector helps to eliminate contact with used strip
- Meter requires only a small sample of 0.5 microliter to lessen patient discomfort

Meter System	1035182	\$21.99 ea.
Test Strips, 50/box.....	1035183	\$13.50 box
Hi-Lo Control Solution	1035184	\$8.99 ea.



TRUE METRIX™ Self-Monitoring Blood Glucose Meter

Easy-to-use, self-monitoring blood glucose meter with advanced event tags empowers user to make the connection between personal lifestyle and results.

Features:

- No coding
- As fast as 4 seconds
- Tiny 0.5 microliter sample size
- Alternate site testing
- Store 500 results with date/time
- 7-, 14- and 30-day averaging
- Four testing reminders
- Audible fill detection
- Control detection
- Ketone test reminder
- Strip release button
- Download capabilities

Includes:

- Meter
 - 3-volt battery
 - Lancing device (uses most lancets)
 - (10) sterile lancets (do not reuse)
 - Instructions for use
 - Self-test log book
 - Compact carrying case
- True Metrix test strips and control solution are not included.

.....	1006626	\$27.35 ea.
True Metrix Test Strips 50/box.....	1006623	\$36.45 box
True Metrix Control Solution Level 1	1006624	\$9.96 ea.
True Metrix Control Solution Level 2	1006625	\$9.96 ea.



DID YOU KNOW?

Testing a site that is still damp from pretest topical alcohol can interfere with a glucometer reading?

Lancets , Glucose & Injection Training



Blood Lancets

Sterile, disposable stainless steel lancets. Can also be used for splinter removal. Individually wrapped. Non-safety.

200/box36021 \$11.85 box



Diabetic Injection Model Kit

Perfect for instruction and injection practice. Looks and feels like human skin. Deep enough to accept all insulin needles. Oval pad is 6 1/4" with hard plastic backing and adjustable plastic buckle.

.....12153 \$96.60 kit



**Meets
CDC Guidelines
for use**

Acti-Lance Safety Lancets

Acti-Lance is a safe and gentle lancet designed for capillary blood sampling. Acti-Lance comes in three different color-coded versions to meet specific blood sample size applications.

- One easy step
- Safe and effective
- Needle is not exposed after use

Lite 1.5mm, 28G, up to 10ml sample size
100/Box36324 \$26.05 box

Universal 1.8mm, 23G, up to 50ml sample size
100/Box36325 \$26.05 box

Special 2.0mm, 17G, up to 500ml sample size
100/Box36326 \$26.05 box



A



**Correct low
blood sugar
on the go!**

B



C



D

A. TRUEplus® Soft Tabs

TRUEplus Soft Tabs each contain 4 grams of pre-measured, fast-acting carbohydrates and offer convenient sizes to fit individual needs. TRUEplus Soft are fat free, sodium free and come in easy-to-open four count pouches.

Chocolate Marshmallow, 4/pkg..... 1030373 \$2.49 pkg.
Cherry Pop, 4/pkg..... 1030374 \$2.48 pkg.
Root Beer, 4/pkg..... 1030375 \$2.48 pkg.
Kiwi Strawberry, 4/pkg. 1030376 \$2.48 pkg.

B. Honey Sticks

Simple to use. Just squeeze the end to release. Each tube contains 5 g of honey.

Clover, 100/pkg.....34198 \$48.85 pkg.
Lemon, 100/pkg.34197 \$48.85 pkg.

C. TRUEplus Glucose Gel

TRUEplus glucose gel contains 15 grams of fast-acting carbohydrates in a squeezable pouch, perfect for emergency situations. This fruit punch flavored gel provides a quick and easy way to raise low blood sugar and boost energy. The gel is fat-free, gluten-free, and sodium-free.

Fruit Punch, 6/box 1033932 \$20.75 box.

TRUEplus Glucose Tabs

Raspberry, 50/pkg 1031301 \$7.04 pkg.
Orange, 10/pkg. 1031298 \$2.06 pkg.
Raspberry, 10/pkg..... 1031300 \$2.06 pkg.

D. TRUEplus Glucose Chewable Tabs

Orange, 50/pkg..... 1033931 \$7.04 pkg.



seca 769 Digital Column Scale with BMI Function

Digital column scale with BMI function (no wall mounted connection needed). With the slip resistant base and anti-tip column design, patients can be safely measured and weighed.

Capacity: 450 lbs x 0.2 lbs
 Dimensions: 11.6" x 32.7" x 16.4"
 Height Rod: 24" - 78"
 Display: Digital w/ BMI functions & measurement station
 Warranty: 3-year
 Ship Weight: 15 lbs.
 Batteries: 4 "AA" included

769 Scale *58067 \$404.50 ea.
 Adapter Only..... *58046 \$93.10 ea.



seca 703 Wireless Column Scale

High capacity column scale with wireless transmission. Cast iron slip resistant base and anti-tip column design for patient safety. Receive height measurements and calculates BMI. Seca height rod included.

Capacity: 660 lbs x 0.1 lbs.
 <330 lbs.> 0.2 lbs.
 Dimensions: 14.2" x 36.6" x 20.5"
 Height Rod: 33" - 78"
 Foot Plate: 14" x 3½" x 14"
 Display: Digital
 Warranty: 3-year
 Ship Weight: 35 lbs.

703 Scale *58047 \$665.50 ea.
 Adapter Only..... *58046 \$93.10 ea.



seca 700 Mechanical Column Scale with Eye-Level Beam

More convenience with eye-level beam, large cast iron base, iron column, and integrated transport castors for mobile use. Seca height rod included.

Capacity: 500 lbs x ½ lbs
 Dimensions: 57½" x 17" x 20"
 Height Rod: 24" - 78"
 Foot Plate: 13¾" x 3¼" x 14¼"
 Display: Beam
 Warranty: 6-year
 Ship Weight: 52 lbs.

700 Scale *58049 \$396.50 ea.



seca 869 Flat Scales with Cable Remote Display

Display can be set up separately from the base and read from its position on the wall or desk. Calculates BMI for nutritional conditions and its low weight compact size allows for easy setup on multiple surfaces.

Capacity: 550 lbs x 0.2 lbs Display: Digital
 <330 lbs.> 0.5 lbs. Warranty: 3-year
 Dimensions: 12" x 2.3" x 12" Ship Weight: 9.5 lbs.
 Foot Plate: 12" x 12"

869 Scale *58081 \$525.00 ea.
 Adapter Only..... *58046 \$93.10 ea.



seca 813 High Capacity Digital Flat Scale

The oversized platform features a tough rubber coating for safety, even under wet conditions. It has a power saving Auto-off to save on battery power.

Capacity: 440 lbs x 0.2 lbs. Warranty: 3-year
 Dimensions: 17" x 1½" x 14½" Ship Weight: 5.7 lbs.
 Display: Digital, Auto Off

..... *58068 \$211.50 ea.

*Direct-ship item. Please allow additional time to receive.

Scales

Health o meter®



A



B



C



D



E



F

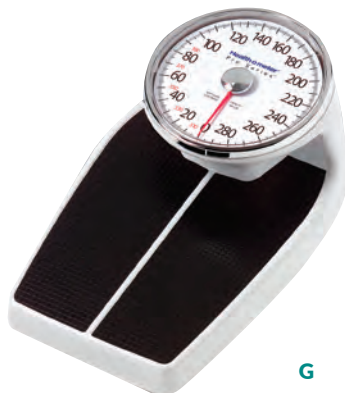

G

**Wall Mount Height Rod
Included with 58057!**

A. Health o meter® Professional Scale 402KL with Height Rod

Capacity: 390 lbs x 0.25 lb
 Dimensions: 10½" x 20½" x 58"
 Height Rod: 24" – 84"
 Foot Plate: 10½" x 14"
 Display: Beam
 Warranty: 10-Year
 Ship Weight: 43 lbs.

without Casters *58002 \$253.00 ea.

with Casters *58003 \$266.00 ea.

B. Health o meter® Professional 500KL Digital Beam Scale with Height Rod

Capacity: 500 lbs x 0.2 lb
 Dimensions: 14½" x 21½" x 53½"
 Foot Plate: 13¾" x 16½"
 Ship Weight: 25 lbs.
 Warranty: 2-year
 Display: Digital LCD with keypad BMI functions.
 6 "AA" batteries included.

Adapter not included.

. *58059 \$453.50 ea.

Adapter Only. *58074 \$62.70 ea.

C. Health o meter® BMI 499KLHR Digital

Capacity: 500 lb x 0.2 lb
 Dimensions: 14½" x 21½" x 43½"
 Height Rod: 24" – 84"
 Foot Plate: 13¾" x 16½"
 Display: Digital, LCD
 Warranty: 2-year
 Ship Weight: 22 lbs.

. *1007356 \$526.00 ea.

D. Health o meter® 800KL Digital

Capacity: 397 lbs x 0.2 oz
 Dimensions: 12¾" x 12¾"
 Display: Digital 1.5" Numbers
 Warranty: 1-year limited
 Ship Weight: 5 lbs.

. 58070 \$65.95 ea.

E. Health o meter® Professional 498KL Digital Remote Display Scale

Capacity: 500 lbs x 0.2 lb
 Dimensions: 13¾" x 16½" x 2¾"
 Foot Plate: 13¾" x 16½"
 Warranty: 2-year
 Ship Weight: 16.25 lbs.
 Display: Digital LCD with keypad
 functions: 120V AC adapter included

. *1006093 \$400.50 ea.

F. Health o meter® Professional

Capacity: 400 lbs x 0.2 lb
 Dimensions: 12" x 12" x 2½"
 Foot Plate: 12" x 12"
 Display: Remote LCD on 9' cord
 9V battery included
 Warranty: 2-year limited
 Ship Weight: 9 lbs.

. 58057 \$265.00 ea.

G. Health o meter® Large Dial

Capacity: 400 lbs x 1 lb
 Dimensions: 13½" x 11"
 Displays: 8" Diameter Dial
 Warranty: 1-year limited
 Ship Weight: 10 lbs.

. *58018 \$102.00 ea.

*Direct-ship item. Please allow additional time to receive.



A



B



C



A. Detecto® Solo Scale

Weight, Height, and Body Mass Index with inline height rod. Two wheels for quick and easy portable transport. Rubber mat for patient assurance and stability.

Capacity: 500 lbs x 0.2 lb
 Dimensions: 14" x 19.5" x 52"
 Height Rod: 30" - 84.5"
 Platform: 14" x 15" x 2.5"
 Display: LCD digits
 Warranty: 1-year
 Ship Weight: 25 lbs.
**1007262** \$439.00 ea.

B. Detecto® School Balance Beam

Capacity: 400 lbs x 0.2 lb
 Dimensions: 10½" x 14½" x 59"
 Height Rod: 30" - 78"
 Foot Plate: 10½" x 14½"
 Display: Beam
 Warranty: 1-year
 Ship Weight: 39 lbs.

without Casters**58001** \$258.50 ea.
 with Casters**58000** \$304.50 ea.
 Combination Metric/English Scale (kg/lbs.;
 cm/in)***58004** \$261.50 ea.
 Combination with Casters
***58005** \$307.00 ea.
 Replacement Height Rod (in/cm)
**58037** \$98.40 ea.

C. Detecto® Apex® Scale

This scale includes inline mechanical height rod, measures from 24 inches (2 ft) up to 86 inches (7'2") by 0.125 inch increments. Calculate BMI, simply use the scroll arrows to enter the height measurement and then press the BMI key.

Capacity: 600 lbs x 0.2 lb
 Dimensions: 17" x 19.5" x 53.3"
 Foot Plate: 17" x 17"
 Display: .75" LCD 12 "AA" batteries not included
 Warranty: 1-year
 Ship Weight: 13 lbs.
***1007494** \$732.00 ea.

FREE SHIPPING at SchoolHealth.com/SportsMed

Get FREE SHIPPING on your online order over \$100! Go to the back cover for Free Ship Online code. Can only be used once per customer. Expires 12-31-20.

*Direct-ship item. Please allow additional time to receive.

Pedometer & Measuring Devices



A



B



C

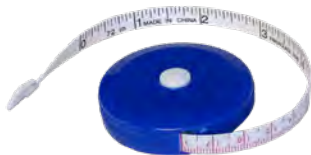

D



E



F



G

A. Pedometer

With a large digital display for easy reading, this pedometer measures distance traveled and comes with a personal stride adjustment feature.

.....**.61673** \$8.49 ea.

B. Lange Skinfold Calipers

Direct, simple and accurate method for estimating leanness to fitness. Accurate to ± 1 mm. Tips pivot automatically for parallel measurement. An easy-to-read scale up to 60 mm. All critical pivot points utilize low friction bearings. Spring-loaded levers provide a constant pressure of 10 g./sq. mm.

.....**.61019** \$494.00 ea.

C. Fat-O-Meter

Plastic skinfold caliper. Easy and economical way to determine body fat percentage.

.....**.61020** \$57.20 ea.

D. Tape Measure

High-impact plastic case with push button retractor. Tape is graduated in inches on one side and centimeters on the other.

1/4" x 60" Tape**.90280** \$1.82 ea.

E. Goniometers

Clear plastic construction permits observation of the joint's axis of motion and its range of motion.

6"**.61177** \$8.99 ea.
 8"**.61178** \$11.99 ea.
 12"**.61163** \$21.99 ea.

F. Seca BMI Calculator

Once height and weight are entered, this handy calculator automatically calculates the BMI. Also functions as a normal calculator. Has eight-digit display. Solar and battery powered. For adult calculations only.

.....**.61305** \$74.60 ea.

G. Seca 217 Stadiometer for Mobile Height Measurement

Exceptionally high degree of stability – almost the same as a permanent installation. In addition, the adjustable spacer ensures a secure hold without any fittings. Suitable for medical practices and hospitals, the stadiometer is also just right for mobile use, such as examinations of children at school or patients at home. When disassembled, the stadiometer is easy to transport.

.....**1033810** \$229.50 ea.

*Direct-ship item. Please allow additional time to receive.

Athletic Training Room Furnishings



Modular Cabinetry	314–315	Therapy & Mat Tables.....	328
Modular Cabinetry Order Form.....	316	Mobile Taping/Treatment Carts	329
Exam Room Cabinetry	317	Hi-Lo Tables	330–331
Portable Tables.....	318–319	Exam Tables & Accessories	331–332
Treatment/Taping Tables & Stations.....	320–321	Mobile Carts & Cabinets	333–334
Taping Stations.....	322	Utility Carts	335
Athletic Trainers Tables.....	323–324	Screens & Lamps.....	336
Treatment Tables.....	325–327	Cubicle Curtains	337
Taping Tables	326–328	Chairs, Stools & Waste Cans.....	338
Modality Carts	327		

Modular Cabinetry

Four Step Guide to Buying Modular Cabinets

School Health's modular cabinetry system is designed to complement our recovery couches and exam tables. Each cabinet features fully concealed, self-closing, three-way adjustable euro hinges and commercial-grade drawer glides. Security locks are standard for all doors and drawers.



1. Measure

Measure the space you have available for your cabinets.**



2. Choose Cabinets

Decide on the wall and base cabinets that will fit your space.



3. Select Options

Choose the cabinet color, countertop and pull type you would like for your cabinets.



4. Order

Use the Modular Cabinetry order form found on page 316 or contact our customer care representatives to order.

MODULAR WALL CABINETS, 30"H X 12 1/4"D

- Security locks for all doors and drawers
- Concealed, self-closing, three-way adjustable euro hinges



Single Door

18" Wide

- A.** With 1 Clear Acrylic Door *24209 \$525.00 ea.
- B.** With 1 Solid Laminate Door *24097 \$364.00 ea.

Double Door

24" Wide

- C.** With 2 Clear Acrylic Doors *24210 \$681.00 ea.
 - D.** With 2 Solid Laminate Doors *24098 \$515.00 ea.
- 30" Wide
- With 2 Clear Acrylic Doors *24211 \$757.50 ea.
 - With 2 Solid Laminate Doors *24099 \$583.00 ea.

Corner

36" Wide (Each Side)

- E.** With 4 Clear Acrylic Doors *24407 \$1,061.00 ea.
- F.** With 4 Solid Laminate Doors *24406 \$821.50 ea.

** Measuring for Wall Cabinets

Once you have finished selecting all your wall cabinets, please add 1 1/2" to the overall width of your configuration.

* Direct-Ship Item. Please specify options when ordering; allow 3-6 weeks for fabrication and delivery after all information has been submitted. See index section for details. Inspect shipments upon delivery.

MODULAR BASE CABINETS, 36"H X 19"D

- Security locks for all doors and drawers
- Commercial-grade drawer glides
- Concealed, self-closing, three-way adjustable euro hinges



A. 1 Door, 2 Adjustable Shelves

18" Wide *24100 \$563.50 ea.

B. 2 Doors, 2 Adjustable Shelves

24" Wide *24223 \$792.50 ea.

30" Wide *24224 \$827.50 ea.

C. 1 Drawer, 1 Door, 1 Adjustable Shelf

18" Wide *24220 \$795.00 ea.

D. 2 Doors, 2 Drawers, 1 Adjustable Shelf

24" Wide *24102 \$1,012.00 ea.

E. 3 Drawers, 2 Doors

30" Wide *24103 \$1,028.00 ea.

F. 5 Drawer

18" Wide *24101 \$975.00 ea.

24" Wide *24221 \$1,025.00 ea.

30" Wide *24222 \$1,108.00 ea.



Towel drop doors allow for easy access to a laundry basket



A. 1 Sink, 2 Doors, 2 Towel Drop Doors

24" Wide *24225 \$1,123.00 ea.

30" Wide *24226 \$1,145.00 ea.

B. 1 Sink, 2 Doors

24" Wide *24227 \$1,024.00 ea.

30" Wide *24228 \$1,128.00 ea.

C. Wheelchair Accessible Sink

36" Wide *24230 \$836.00 ea.

D. Corner

2 Doors, 1 Lazy Susan, 2 Adjustable Shelves

36" Wide (Each Side)

..... *24408 \$1,168.00 ea.

*Direct-Ship Item. Please specify options when ordering; allow 3-6 weeks for fabrication and delivery after all information has been submitted. See index section for details. Inspect shipments upon delivery.

OPTIONS FOR MODULAR CABINETS

Pull Styles



Aluminum



Solid Maple

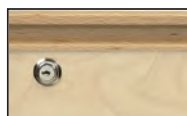

Solid Oak



Wire Pulls

Countertop Colors



White



Fog



Folkstone



Almond

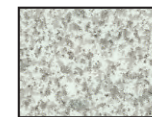

Fog Dust

Cabinetry Colors



White



Fog



Folkstone



Almond

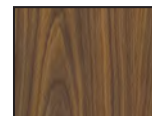

Walnut



Maple



Oak

**Measuring for Base Cabinets

Once you have finished selecting all your base cabinets, please add 2" to the overall width of your configuration.

Modular Cabinetry Order Form

To expedite the ordering process, please submit this form, along with order form on pages 303–304, when placing an order for the Modular Cabinetry found on pages 260–261. The exam cabinets on page 263 are not configurable; please use order form on pages 303–304.

Name: _____ Phone: _____

CHOOSE MODULAR CABINETS

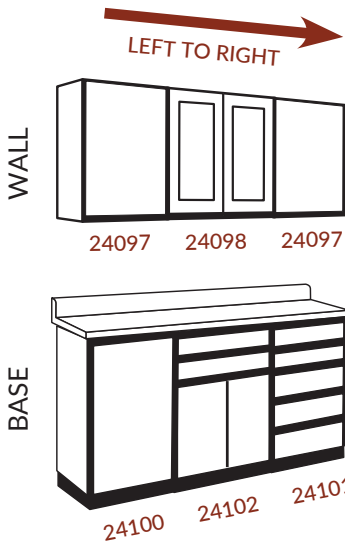

Enter your cabinet choices in the boxes below. Begin with the farthest left cabinet and proceed to the right, if there is to be a series of cabinets.

1. Top row: fill in the item number(s) for the chosen wall cabinet(s).
2. Bottom row: fill in the item number(s) for the chosen base cabinet(s).

WALL					
------	--	--	--	--	--

(List Wall Cabinets from left to right in these boxes.)

Add total configurations, plus 1½" for end panels, to obtain the total width.

BASE					
------	--	--	--	--	--

(List Base Cabinets from left to right in these boxes.)

Add total configurations, plus 2" for countertop overhang, to obtain the total width.

Cabinet Alignment

When ordering, please indicate whether cabinets are to be flush to left wall, right wall or centered with both left and right sides exposed.

- Flush with Wall on Left
- Centered (neither side exposed)
- Centered (left and right sides exposed)
- Flush with Wall on Right

SELECT COLORS AND PULL STYLES FOR MODULAR CABINETS



Pull Styles



Aluminum



Solid Maple



Solid Oak



Wire Pull



Countertop Colors

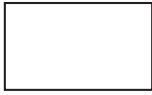

White



Fog



Folkstone

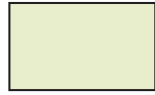

Almond

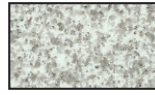

Fog Dust

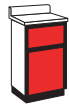

Cabinetry Colors

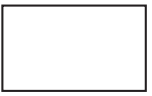

White



Fog



Folkstone

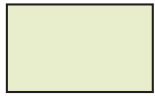

Almond



Walnut



Maple



Oak

Request Samples

Contact Customer Care at 866-323-5465 to request samples of cabinet colors.

DELIVERY INFORMATION

- Lift-Gate Delivery: Mechanical plate on back of truck to lower freight to ground level used when there are no loading docks for handling heavy merchandise. (Additional charges apply—call for details).
- Inside Delivery: For freight orders, delivery that is taken off the back of a truck and carried into customer's facility by delivery company driver. (Additional charges apply—call for details.)

Direct-Ship Items

Allow 3–6 weeks for fabrication and delivery after all necessary information has been submitted. Call us toll-free at 866-323-5465 for a shipping estimate.

PLACE YOUR ORDER

Submit this form, along with order form on pages 359–360. Contact Customer Care at 866-323-5465 for more information.

EXAM ROOM CABINETS

These affordable cabinets are durable and easy to clean. To offer a better value, these Exam Room Cabinets are available in a limited amount of configurations and colors. Comes with chrome wire pull handles.

Panels, doors, drawer fronts and countertops are all matching for the color you choose. **Custom configuration is not available for Exam Room Cabinets.**



Wall Cabinets, 30"H x 12"D

- A.** 19.5"W, 1 Door, and 2 Shelves
..... *24881 \$204.00 ea.
- B.** 25.5"W, 2 Doors and 2 Shelves
..... *24882 \$334.50 ea.
- C.** 31.5"W, 2 Doors and 2 Shelves
..... *24883 \$439.50 ea.
- D.** 49.5"W, 3 Doors and 4 Shelves
..... *24884 \$639.50 ea.
- E.** 73.5"W, 5 Doors and 6 Shelves
..... *24885 \$968.50 ea.

Base Cabinets — 36"H x 18"D (Countertop adds 2" to cabinet width)

- F.** 26"W, 1 Drawer, 2 Doors and 1 Shelf
..... *24886 \$589.00 ea.
- G.** 32"W, 1 Drawer, 2 Doors and 1 Shelf
..... *24887 \$857.00 ea.
- H.** 44"W, 2 Drawers, 3 Doors and 2 Shelves
..... *24888 \$1,250.00 ea.
- 50"W, 2 Drawers, 3 Doors and 2 Shelves
..... *24889 \$1,299.00 ea.
- I.** 68"W, 3 Drawers, 4 Doors and 3 Shelves
..... *24891 \$1,760.00 ea.
- J.** 74"W, 3 Drawers, 5 Doors and 3 Shelves
..... *24892 \$1,981.00 ea.

Available Options—Must be Ordered with Cabinets to Receive Price

- Lock (2 Door Cabinets Require Only 1 Lock)
..... *24895 \$60.85 ea.
- K.** Work Station Slide Out (For 18" and 24" Base Cabinets Only)
..... *24894 \$70.95 ea.
- L.** Stainless Steel Gooseneck Faucet and Strainer Basket** (For 24888, 24889, 24891 and 24892 only)
..... *24893 \$329.00 ea.

** With the addition of a sink, one drawer will be removed from base cabinet.

EXAM ROOM CABINET COLORS

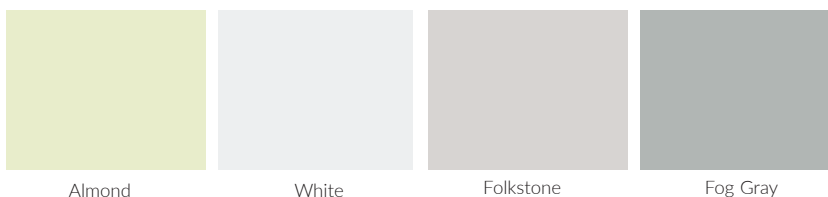

Almond

White

Folkstone

Fog Gray

Placing Order For Exam Room Cabinets

The Exam Room Cabinets are not configurable; please use order form on pages 359–360.

*Direct-Ship Items

Allow 3–6 weeks for fabrication and delivery after all necessary information has been submitted. Call us toll-free at 866-323-5465 for a shipping estimate.

Portable Tables



Proteam Portable Taping Table

The ProTeam Taping Table features durable, maintenance-free surfaces for years of heavy-duty use.

Weight: 22 lbs. Size: 48"L x 24"W x 27"H
 *1031636 \$629.99 ea.



Oakworks Boss Table

Features sealed seams, water-resistant undercoating and puncture-resistant surface which stands up to even the most extreme field conditions. Please specify table width and color when placing order.

Available in 27", 29" and 31" Widths
 Weight Capacity: 600 lbs.
 Height Range: 24"-34", Length: 73"

Table	*24352	\$834.99 ea.
Carrying Case	*24353	\$131.99 ea.
Table & Case	*24354	\$984.99 ea.



Proteam Portable Treatment and Sideline Table

- 2½" thick, multi-layered, semi-firm foam
- Comfortable PVC-free urethane upholstery
- Lightweight aluminum frame weighs only 30 lbs.
- Push-button height adjustment
- Includes adjustable face cradle with ultra-soft face cushion and carry bag with shoulder sling
- Spacious 73"L long x 28"W top
- Height adjustable from 24"-32"
- Removable 2" Turf Pad (set of four included as a courtesy for outdoor use)

Weight Capacity: 600 lbs., 73"L x 28"W x 24"-32"H
 Black *24914 \$617.00 ea.
 Blue *24915 \$617.00 ea.



Oakworks Portable Taping Table

Features independently adjustable legs and unique field feet. Marine-grade polymer top and shoulder strap on table.

Color: Black Only
 Weight Capacity: 500 lbs., Width: 24"
 Height Range: 32"-42", Length: 48"

Table	*24355	\$776.99 ea.
Carrying Case	*24356	\$172.99 ea.
Table & Case	*24357	\$938.99 ea.

Color Chart for Oakworks Tables

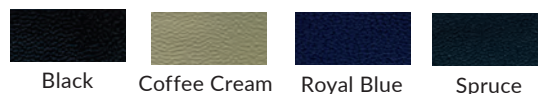

Black Coffee Cream Royal Blue Spruce

*Direct-ship item. Please allow additional time to receive. Please specify colors when ordering; allow 3-6 weeks for fabrication and delivery after all necessary information has been submitted.



Impact Athletic Medic and Medic XL Mobile Athletic Training Station

With onboard storage and all-terrain wheels, the MEDIC and MEDIC XL quickly and easily brings your workstation to the sideline. The MEDIC is on field Athletic Training equipment to keep you in the game.

Features

- Aluminum construction - Lightweight yet strong; will not rust, rot or absorb moisture like wood; powder-coated for durability; can be power-washed clean
- Table folds up & wheels fold out - Easy to store; wheels make travel easy
- Locking storage - Access from both sides
- 2 bungee cords included to fasten additional equipment & supplies for transportation
- Load rating - Medic - 500 lbs. capacity / Medic XL - 750 lbs. capacity

A. Medic

Red.....*24902 \$2,259.99 ea.

B. Medic XL

Red.....*24908 \$2,749.99 ea.



ATHLETIC EDGE Aluma Elite Portable Workstation

The Aluma Elite Portable Workstation, with industry leading mobility features, is Athletic Edge's latest solution for sideline treatment and care. Made from aluminum, and complimented with a rugged, textured powder coat finish, this workstation offers an affordable and convenient solution for treating your athletes. The Aluma Elite Portable Workstation also features a stow-away handle, lockable storage cabinet that is accessible from both sides, marine grade plastic top and graphics package including two logo panels on top.

- Load capacity: 750 lbs.
- 24"W x 73"L x 32"H (Open)
- 27"W x 24"L x 32"H (Folded)
- Durable aluminum frame
- Textured powder coat finish with optional accent color
- 6" Pneumatic wheels
- Stow-away handle
- Lockable storage cabinet with access from both sides
- Marine grade plastic top
- Graphics package included

Portable Workstation

24"W x 73"L x 32"H 1033523 \$2,675.00 ea.

Workstation Cover..... 1033506 \$172.50 ea.



Treatment/Taping Tables & Stations

Professional Treatment Tables

Our treatment/taping tables provide an array of designs and arrangements to suit your health room needs. They feature security locks, spacious cabinets, and your choice of door and drawer pulls. The tables shown are finished in popular laminate colors. Locking systems are standard in all our cabinetry.

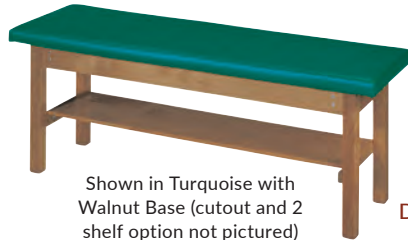

Shown in Black with Natural Base (backrest and cutout option not pictured)

Shown in Turquoise with Walnut Base (cutout and 2 shelf option not pictured)

Shown in Regimental Blue with Natural Base (cutout and 2 shelf option not pictured)

Shown in Teal with Natural Base (backrest and 2 shelf option not pictured)

Color and Base Options

Refer to page 321 to select your furniture color options.

Professional Treatment Table with Enclosed Storage					
Description	Length	Width	Height	Item #	Price
A. With Enclosed Cabinet, Sliding Doors and One Fixed-Position Shelf (Shown)	78"	30"	30"	*24315	\$1,253.00 ea.
with Backrest	78"	30"	30"	*24316	\$1,628.00 ea.
B. With Enclosed Central Cabinet and Two Shelves					
(Shown)	78"	30"	30"	*24187	\$1,018.00 ea.
with Backrest	78"	30"	30"	*24188	\$1,182.00 ea.
C. With Three 20" Wide Drawers on Nylon Rollers with Positive Stops					
(Shown)	78"	30"	30"	*24317	\$1,275.00 ea.
with Backrest	78"	30"	30"	*24318	\$1,454.00 ea.

Professional Treatment Table with Open Storage					
Description	Length	Width	Height	Item #	Price
D. With Full Length Shelf					
(Shown)	78"	24"	30"	*24212	\$733.00 ea.
(Not Shown)	78"	30"	30"	*24191	\$793.00 ea.
E. With Full Length Shelf and Backrest					
(Shown)	78"	24"	30"	*24213	\$890.00 ea.
(Not Shown)	78"	30"	30"	*24192	\$987.00 ea.
F. With Full Length Shelf and 2 Shelf Compartment					
(Shown)	78"	30"	30"	*24185	\$890.50 ea.
With Backrest	78"	30"	30"	*24186	\$983.50 ea.
G. With Full Length Shelf With Face Cutout					
(Shown)	78"	24"	30"	*24320	\$641.50 ea.
(Not Shown)	78"	30"	30"	*24321	\$807.50 ea.
With Backrest	78"	24"	30"	*24322	\$830.00 ea.
With Backrest	78"	30"	30"	*24324	\$976.50 ea.



Royal Blue

Black

Our exclusive EXPRESS Ship Program will get your *SH* Treatment Table (24191) shipped within three days of order receipt. The Three-Day EXPRESS Table is limited to Black or Royal Blue on a Natural base. Other colors are still available for this treatment table with normal delivery times.

Treatment/Taping Tables & Stations



6-Legged Treatment Table

This unique design features six legs to distribute weight more easily, and a dropped shelf for extra stability.

78"L x 30"W x 30"H

With Shelf *24497 \$789.99 ea.
 With Shelf and Backrest (Shown)..... *24498 \$1,189.99 ea.



School Health Brand Mat Table

Features the same premium hardwood construction as our standard treatment tables. With a 2" foam top upholstered in your choice of Premier Texhyde® vinyl. When ordering, indicate base and upholstery colors. Custom sizes available.

84"L x 45"W x 21"H *24215 \$1,079.99 ea.



Dual Taping Station

69"L x 36"W x 38"H, Shipping Weight: 460 lbs.

With Upholstered Top..... *24339 \$2,329.99 ea.
 With Laminate Top..... *24338 \$2,329.99 ea.

Single Taping Station (Not Shown)

44"L x 36"W x 38"H, Shipping Weight: 318 lbs.

With Upholstered Top..... *24341 \$1,504.99 ea.
 With Laminate Top..... *24340 \$1,504.99 ea.



Taping Table with Two Storage Shelves

48" L x 24" W x 36" H, Shipping Weight: 119 lbs.

With Upholstered Top..... *24195 \$624.99 ea.
 With Laminate Top..... *24346 \$499.99 ea.

Taping Table with H-Brace (Not Shown)

48" L x 24" W x 36" H, Shipping Weight: 106 lbs.

With Upholstered Top..... *24194 \$484.99 ea.
 With Laminate Top..... *24345 \$389.99 ea.

1. Select Base Veneer Finish 2. Select Upholstery Color - Naugahyde® Selection Decorative, vinyl coated fabric



Natural



Walnut



Please Note: Colors are applied to a wood veneer and will differ slightly in appearance from a laminate of the same color.

How To Order Treatment Tables

* Direct-Ship Item. Please allow additional time to receive.

Taping Stations

PROTEAM™
by HAUSMANN

Taping Station Features:

- Upholstered Taping Modules are 36" H or 42" H
- You can order individual taping or storage modules
- Durable dowel-and-glue, laminated wood construction
- Self-closing laminate drawer with nylon rollers
- Doors have concealed, adjustable, self closing 110° euro-hinges
- All doors and drawer fronts have 3 mm high-impact edging
- 2" thick, high-density foam tops are removable without tools
- Weight capacity of up to 450 lbs



Select Series Stations

Description	Length	Height	Depth	Item #	Price
A. With Two Seats and Hamper (24514) ...	72"	32"	32"	24499	\$3,389.99
B. With Two Seats	72"	36"	36"	24500	\$3,109.99
.....	72"	36"	42"	24501	\$3,309.99
.....	72"	36"	48"	24502	\$3,479.99
.....	72"	42"	36"	24503	\$3,159.99
.....	72"	42"	42"	24504	\$3,344.99
.....	72"	42"	48"	24505	\$3,559.99
With Three Seats (Not Shown)	120"	36"	36"	24506	\$4,934.99
C. With Four Seats	168"	36"	36"	24507	\$6,859.99

Note: 24515 not available on 36"D tables.

Add Custom Logo

Contact School Health Customer Service to add a custom logo to your table.



Embossed



Debossed

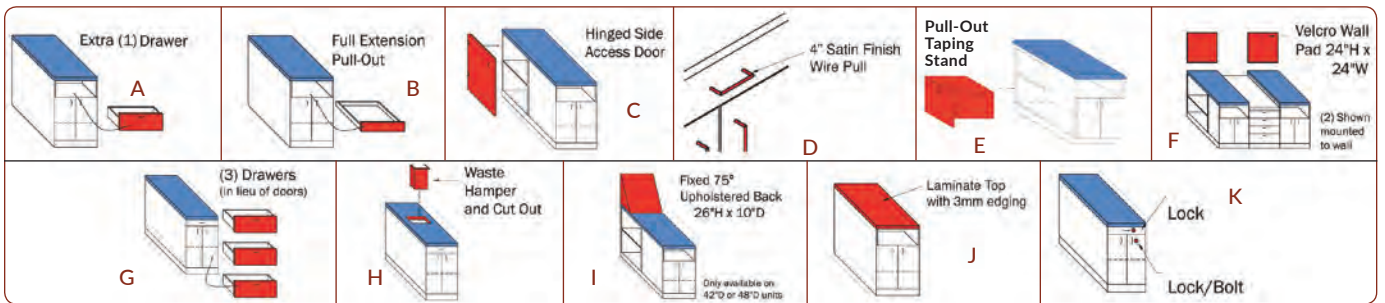

Select Custom Options (for Tables B and C Only)

A. Extra (1) Drawer ...	24508	\$154.99 ea.
B. Full Extension Pull-Out	24509	\$119.99 ea.
C. Hinged Side Access Door, Specify Right or Left	24510	\$139.99 ea.
D. 4" Satin Finish Wire Pull	24511	Free Option
E. Pull-Out Taping Stand Side	24901	\$334.99 ea.
Front	24899	\$334.99 ea.

F. Velcro® Wall Pad, 24" H x 24" W	24512	\$204.99 ea.
G. 3 Drawers (Replacing Doors)	24513	\$384.99 ea.
H. Waste Hamper and Cut-Out	24514	\$159.99 ea.
I. Fixed 75° Upholstered Back, 26"H x 10" D	24515	\$439.99 ea.
J. Laminate Top with 3 mm Edging	24516	Free Option
K. Lock	24517	\$56.99 ea.
Lock with Bolt	24518	\$104.99 ea.

Select Laminate



*Direct-Ship Item. Please specify color when ordering; allow 3-6 weeks for fabrication and delivery after all information has been submitted.

Select Vinyl Color



Athletic Trainers Tables



PROTEAM™
by HAUSMANN

Shown with Optional Gas Spring Backrest (24896)



Hinged Door, Split Leg Table

- Six hinged doors with interior shelf offer concealed supply storage
- Each padded leg rest can be adjusted and locked into desired angle up to 45° with spring-loaded lock-in lever
- Comfortable, 2" thick, high-density foam upholstered tops
- Specify Natural Oak, Wild Cherry or Folkstone Gray laminate
- Optional gas spring backrest adjusts 0°-75°, 600 lbs. weight capacity

Weight Capacity: 600 lbs.

78"L x 30"W x 31"H

.....*24520 \$2,154.99 ea.
Optional Gas Spring Backrest**24896 \$309.50 ea.

**Backrest option must be ordered at time of table purchase.

Two-Person Taping Table/Convertible Treatment Table

- Two padded taping sections 26"W x 34"D x 36"H with removable middle top pad
- Three storage sections with Oak laminate interiors and shelf
- (1) Center drawer on nylon rollers
- Doors have concealed, adjustable, self-closing euro-hinges
- 2" high-density, urethane foam, vinyl top
- Only available in Natural Oak laminate

Weight Capacity: 500 lbs.

74"L x 34"W x 36"H*24521 \$2,579.99 ea.



H-Brace Taping Table

- 36" is convenient height for taping
- High-pressure laminate legs, apron and stretchers
- Only available in Natural Oak laminate
- Legs have protective, black vinyl scuff caps
- 2" thick, high-density foam, vinyl upholstered top

Weight Capacity: 350 lbs.

48" L x 24" W x 36" H*24472 \$539.99 ea.



Athletic Trainer's Table

- Six legs and plywood top for added strength
- New enhanced leg hardware system
- Laminate shelf with two long stretchers
- 30" x 78" upholstered top with 2" high-density foam
- Legs have protective, black vinyl scuff caps
- Specify Natural Oak or Wild Cherry laminate

Weight Capacity: 600 lbs.

78"L x 30"W x 31"H*24522 \$1,014.99 ea.

FREE SHIPPING at SchoolHealth.com/SportsMed

Get FREE SHIPPING on your online order over \$100! Go to the back cover for Free Ship Online code. Can only be used once per customer. Expires 12-31-20.

*Direct-ship item. Please allow additional time to receive.

Athletic Trainers Tables



Optional Gas Spring Backrest



Proprint™ Logo Caps

Add your team logo to your Proteam Tables with this low-cost alternative to customizing the upholstery. Your team logo or graphic is digitally printed on a heavy-duty vinyl upholstery slip-on cap, measuring 9" high and the width of the backrest.

Proteam Logo Cap 1007027 \$169.99 ea.

Add your team logo here!



Proteam™ Split Leg Lift Tables

- Extremely versatile and functional split leg design
- Each padded leg rest can be adjusted and locked into desired angle up to 45° with spring-loaded, lock-in lever
- Open shelf storage, accessible from both sides of the table
- Comfortable, 2" thick, high-density foam upholstered tops
- Choice of Natural Oak, Wild Cherry or Folkstone Gray laminate
- Choice of nine Pro-Form™ vinyl colors

Weight Capacity: 600 lbs.

78"L x 30"W x 31"H

Open Storage with Split Leg *24519 \$1,689.99 ea.

Six hinged doors on both sides with Split Leg *24916 \$2,244.99 ea.

Open Storage without Split Leg *24917 \$1,139.99 ea.

Six hinged doors on both sides without Split Leg *24918 \$1,844.99 ea.

Proteam™ Six Leg Split Leg Table

- Extremely versatile and functional split leg design
- Each padded leg rest can be adjusted and locked into desired angle up to 45° with spring-loaded, lock-in lever
- Six legs and plywood top for added strength
- Laminate shelf with two long stretchers
- 30" x 78" upholstered top with 2" high-density foam
- High-pressure laminate legs, apron and H-brace
- New enhanced leg hardware system
- Legs have protective, black vinyl scuff caps
- Natural Oak or Wild Cherry laminate
- Choice of nine Pro-FORM™ vinyl upholstery colors
- Optional gas spring backrest adjusts 0°–75°, 600 lbs. weight capacity

Weight Capacity: 600 lbs.

Without Backrest *24919 \$1,614.99 ea.

Optional Gas Spring Backrest **24896 \$309.50 ea.

**Backrest option must be ordered at time of table purchase.

Select Laminate



Select Vinyl Color



* Direct-Ship Item. Please allow additional time to receive. Please specify colors when ordering; allow 3-6 weeks for fabrication and delivery after all necessary information has been submitted.

**Factory installed option must be ordered with the table.

Green-Line Eco-Friendly Products

An environmentally safer alternative to traditional materials for improved air quality

✓ Exceeds CARB I and II standards

✓ All Green-Line wood has no added urea-formaldehyde

✓ All urethane fabric is CAL 01350

✓ PVC-free construction



Eco-Friendly Treatment Tables

- H-brace is recessed into table leg with unique four-sided Lock-Tite joint
- Fusion Maple high-pressure laminate legs, apron and stretchers

A. Treatment Table 72"L x 24"W x 31"H
*24835 \$600.00 ea.
 72"L x 30"W x 31"H

.....*24836 \$665.00 ea.

Treatment Table with Shelf

72"L x 24"W x 31"H
*24837 \$703.50 ea.

72"L x 30"W x 31"H
*24838 \$735.50 ea.

B. Treatment Table with Cabinet

- Fully-enclosed, all-laminate cabinet with sliding laminate doors
- Interior has divider and one adjustable shelf
- Fusion Maple laminate

72"L x 30"W x 31"H
*24839 \$1,574.99 ea.

Accessories

Optional backrest and paper dispenser are not included. Backrest must be ordered at the same time as the treatment tables.

C. Optional Backrest with Gas Springs
24896 \$309.50 ea.

D. Optional Paper Dispenser
24897 \$56.00 ea.

E. Eco-Friendly Carts

- Two 5½" Drawers and one 8½" deep Drawer
- Maintenance-free Fusion Maple laminated surfaces on all cabinet exteriors and interiors
- 2½" twin wheel-hooded-swivel nylon casters

18.5"L x 18.5"W x 30"H
*24841 \$509.50 ea.



PVC-FREE Urethane Top Color Options



* Direct-Ship Item. Please specify color when ordering; allow 3-6 weeks for fabrication and delivery after all information has been submitted.

Treatment/Taping Tables

2 Seat Tilt Taping Station Shown with Options



ATHLETIC EDGE Modular Taping Station

From individual taping seats and cabinets to five seat taping stations, the configuration options are endless. All taping stations are solidly constructed and fully finished, with several laminate and wood options available.

- Load Capacity: 450 lbs. per seat
- Dowel and glue construction
- Fully finished cabinets
- Laminate and wood options
- Full extension drawer glides
- Front and side access
- Black wire pull handles
- 110° Euro Hinges on doors
- Seamless 2" high density foam cushion
- Rounded corners
- Depths (Flat Taping Seats): 36", 42" or 48"
- Depths (Tilt Taping Seats): 42" or 48"
- Heights: 36" or 42"
- Width: 24"W Cabinet (26"W Cushions)

Flat Seats: 36"H x 36"D (No Back Cushions)

2 Seat - 74"W (2 Seats & 1 Center)	1032355	\$2,629.99 ea.
3 Seat - 122"W (3 Seats & 2 Centers)	1032397	\$4,344.99 ea.
4 Seat - 170"W (4 Seats & 3 Centers)	1032439	\$6,054.99 ea.
5 Seat - 218"W (5 Seats & 4 Centers)	1032481	\$7,764.99 ea.

Tilt Seats: 36"H x 42"D

2 Seat - 74"W (2 Seats & 1 Center)	1032538	\$3,414.99 ea.
3 Seat - 122"W (3 Seats & 2 Centers)	1032565	\$5,529.99 ea.
4 Seat - 170"W (4 Seats & 3 Centers)	1032593	\$7,644.99 ea.
5 Seat - 218"W (5 Seats & 4 Centers)	1032621	\$9,754.99 ea.



Shown with Options

ATHLETIC EDGE CAB-010 Treatment Cabinet

Your athletic training room will shine with the addition of this custom branded treatment cabinets. Meets the functional needs of athletic trainers and therapists, with ample storage plus 55" lift back with manual gas shock and 45" split leg options.

- Load Capacity: 600 lbs.
- 3 Section cabinet
- (6) Hinged doors on front and solid back
- (1) Adjustable shelf in each section
- Available in wood or laminate finishes
- 110° Euro hinges on doors
- 2" High density foam cushion
- Rounded corners
- Black wire pull handles
- Lift back and split leg options

Standard CAB-010: 78"L 30"W x 31"H, Flat Cushion, Doors on Right. **1031216** \$1,687.00 ea.



ATHLETIC EDGE Edge Sport Wood Treatment Tables

Edge Sport Wood Treatment Tables come standard with solid hardwood legs and base, H-brace construction, thick ¾" plywood top, comfortable 2" high density foam cushion, softly rounded corners and dual-bolted leg assembly that folds down for easy shipping. Make it your own by adding length or width, shelves or a cabinet that can be mounted on either end. Patient-friendly customizations include a nose hole and 70° manual lift back with 6 position elevation.

Standard 4 Leg Table:

27"W x 72"L, Flat Cushion.	*1032749	\$595.00 ea.
30"W x 72"L, Flat Cushion.	*1032758	\$625.00 ea.
27"W x 78"L, Flat Cushion.	*1032756	\$635.00 ea.
30"W x 78"L, Flat Cushion.	*1032760	\$650.00 ea.
27"W x 72"L, Lift Back Cushion.	*1031708	\$708.00 ea.
30"W x 72"L, Lift Back Cushion.	*1032766	\$719.00 ea.
27"W x 78"L, Lift Back Cushion.	*1032764	\$724.00 ea.
30"W x 78"L, Lift Back Cushion.	*1032768	\$749.00 ea.



A



B

ATHLETIC EDGE Stor-Edge™ Modality Carts

- Available in wood or laminate finishes
- Full extension glides on all drawers
- 110° Euro hinges on doors
- Black wire pull handles
- 2" Swivel nylon casters
- Carts ship fully assembled, except for casters

24"W x 32"H x 18"D, (1) 5.5" Drawer, and (1) Adjustable Shelf	1032817	\$514.99 ea.
A. 24"W x 32"H x 18"D, (1) 5.5" Drawer, Double Doors and (1) Adjustable Shelf.	1032824	\$549.99 ea.
24"W x 38"H x 18"D, (2) 5.5" Drawers, Double Doors and (1) Adjustable Shelf.	1032886	\$704.99 ea.
B. 24"W 38"H x 18"D, (5) 5.5" Drawers	1032893	\$914.99 ea.

GO-TO Go to page 329 for Athletic Edge color choices

Taping Stations, Treatment Tables & Modality Carts



Athletic Edge Aluma Elite Taping Stations

The Aluma Elite Taping Station is made from durable aluminum and comes with standard tape holders and shelves on each taping seat. Taping seats can be ordered in 36" or 42" heights and can accommodate depths of 36", 42", or 48".

- Taping seats can be ordered in 36" or 42" heights and can accommodate depths of 36", 42" or 48"
- Load capacity: 500 lbs.
- Cabinet with 3 drawers and phenolic top
- Tape holder and shelf on each taping seat
- Waste bin cutout on center cabinet
- 2" Semi-firm foam cushion with rounded corners
- Graphics package included

..... **1033509** \$2,654.99 ea.



ATHLETIC EDGE Aluma Elite Treatment Tables

- Load capacity: 750 lbs.
- Durable aluminum construction
- Tough, powder coat finish
- Tape holder on each end
- Bottom shelf
- Graphics package included
- 2" Semi-firm foam cushion
- Rounded corners

Standard Table 30"W x 31"H x 78"D, Flat cushion, Bottom shelf
(Does not include options listed below. Must order options at the time of table purchase)

..... **1007434** \$1,915.00 ea.

Optional Accessories:

- Storage Cabinet With (2) 7" Drawers **1007443** \$585.00 ea.
- 45° Split Leg Cushion **1007442** \$510.00 ea.
- 70° Lift Back Cushion **1007444** \$499.00 ea.
- Lift Back and Split Leg Cushion **1033513** \$963.00 ea.
- Storage Cabinet with (2) 7" Drawers **1007443** \$585.00 ea.
- Heavy Duty Drawer Liner (per drawer)..... **1033803** \$33.55 ea.



ATHLETIC EDGE Aluma Elite Modality Carts

- Load capacity: 500 lbs.
- 31"W x 23"D x 38"H
- Durable aluminum with powder coat finish
- Aluminum top with electrical grommet
- 5.5" drawer(s)
- Drawer/door key locks
- 2" non-marking casters with brakes
- Graphics package included

- A.** (1) Top Drawer, (2) Bottom Doors and (1) fixed height shelf **1007436** \$1,534.99 ea.
- B.** (4) Drawers **1007437** \$1,899.99 ea.
- (1) Top Drawer and Open Bottom with 4 Drying Racks **1007466** \$2,034.99 ea.
- (1) Top Drawer and Open Bottom **1007467** \$1,289.99 ea.



A



B

GO-TO

Go to page 329 for Athletic Edge color choices

Therapy, Treatment & Mat Tables



Shown with options

ATHLETIC EDGE Leg and Shoulder Therapy Table

Ergonomically designed, the LAST Leg & Shoulder Therapy Table with Hi-Lo Elevating Base is the first treatment/exercise table that supports bilateral training and specific anatomical positioning to achieve the desired results for both professional athletes and weekend warriors. The elevating base ensures that even athletes with limited mobility have easy access in any setting. To maximize your efforts as physical therapists, athletic trainers and clinicians, the LAST table is a must for your rehabilitation practice or training rooms.

- Lifting Capacity: 650 lbs.
- Adjustable top with elevating base
- White powder coat base
- Whisper quiet lift system
- Single Foot Control Pedal
- Elevating Back 0 - 70°
- Elevating Legs 0 - 90°
- Leg Height of 17"
- Drop Legs 0-90°
- 2" High density foam cushions
- Rounded Corners
- Low profile locking casters

84"L x 30"W x 19"-37"H

650 lbs. Lift Capacity **1007547** \$4,139.99 ea.

Options:

Dual Foot Control Pedal. **1033590** \$274.99 ea.

Dual Foot Bar Control..... **1033591** \$324.99 ea.



3 Section Cushion Configuration Shown with options

ATHLETIC EDGE Thera-P Electric Treatment Tables

Ease of use, multiple options and a sleek but durable design make the THERA-P line of electric treatment tables the choice of therapists everywhere. Six top options allow therapists to choose the table that best meets their needs and that ensures patients' most comfortable positioning. The THERA-P electric treatment table is constructed of precision-cut flat and tube steel for durability and style. It also has a whisper-quiet lift system (with elevating foot pedal) and easy-to-operate caster system for better ergonomics.

- Lifting Capacity: 650 lbs.
- Durable and stylish steel base
- White powder coat base
- Whisper quiet lift system
- Single Foot Control Pedal
- 27" Wide cushions
- 6 Different cushion configurations
- 2" High density foam cushions
- Rounded Corners
- Low profile locking casters
- Head Section Angle Range: +40° to -90°
- Lower Extremity Angle Range: 0 to 65°
- Armrest Horizontal Range: 0 to 45°
- Armrest Vertical Range: 0 to 7"

77"L x 27"W x 17"-35"H

1 Section Cushion Configuration **1033555** \$1,759.99 ea.

2 Section Cushion Configuration **1033556** \$1,924.99 ea.

3 Section Cushion Configuration **1033557** \$2,219.99 ea.

4 Section Cushion Configuration **1033560** \$2,274.99 ea.

5 Section Cushion Configuration **1033558** \$2,389.99 ea.

6 Section Cushion Configuration **1033559** \$2,499.99 ea.

Options:

30"W Cushion. **1033571** \$69.99 ea.

Dual Foot Control Pedal. **1033590** \$274.99 ea.

Dual Foot Bar Control..... **1033591** \$324.99 ea.



6 Section Cushion Configuration Shown with options

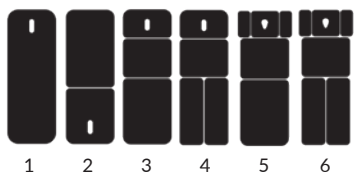

ATHLETIC EDGE Aluma Elite Mat Tables

- 800 lbs Load rating on 4 Leg configuration and 1200 lbs. on 6 Leg configurations
- Durable aluminum construction
- Tough powder coat finish
- Tape holder on each end
- Leveling feet
- 1.5" Semi-firm foam cushion with rounded corners
- Graphics package included



4 Leg, 7'L x 4'W x 18"H **1033517** \$1,199.99 ea.

6 Leg, 7'L x 5'W x 18"H **1033518** \$1,314.99 ea.

6 Leg, 8'L x 6'W x 18"H **1033519** \$1,529.99 ea.

GO-TO Go to page 329 for Athletic Edge color choices



ATHLETIC EDGE SmartCarts™

The SmartCart is durable, functional and convenient. With its heavy-duty 1¼" tube steel frame, panel steel construction and ample storage, this product is sure to meet all your mobile taping, evaluation and/or treatment needs.

- 4', 6' and 6' PRO Load Rating: 800 lbs.
- 8' and 8' Hydration Load rating: 1,000 lbs.
- Drawer and Removable shelf configurations
- Locking, garage style doors
- Full length pass through storage
- Durable construction with black powder coat
- 360° Rotating heavy duty locking wheels
- Pull handle and 1¼" Receiver hitch
- Lift back cushion(s)
- 2" High density foam cushion
- Rounded corners
- Graphics package included

- A.** 4' SmartCart, 50"L x 26"W x 36"H, (1) Lift Back, (3) Drawers, (2) Shelves and Open Full Length Storage . . . **1033531** \$3,889.99 ea.
- B.** 6' SmartCart, 73"L x 26"W x 36"H, (1) Lift Back, (3) Drawers, (1) Shelf and Open Full Length Storage. **1033533** \$5,039.99 ea.
- C.** 6' PRO SmartCart, 73"L x 32"W x 36"H, (1) Lift Back, (3) Drawers, (2) Shelves and Open Full Length Storage **1033534** \$6,244.99 ea.
- D.** 8' SmartCart, 97"L x 26"W x 36"H, (2) Lift Backs, (6) Drawers, (2) Shelves and Open Full Length Storage **1033535** \$6,174.99 ea.
- E.** 8' Hydration SmartCart, 97"L x 26"W x 36"H, (1) Lift Back, (3) Drawers, (1) Shelf, Open Full Length Storage and Hydration Storage **1033536** \$6,174.99 ea.
- F.** Single Cooler Hydration SmartCart, 38"L x 24.5"W x 38"H, (1) 10 Gallon Cooler, (1) Shelf and (1) Garbage Can (Graphics not included). **1033581** \$1,259.99 ea.

Mobile Taping/Treatment Carts



ATHLETIC EDGE The Sport Aluminum Treatment Table

The Sport portable aluminum treatment table is rugged yet lightweight and functional. It comes standard with a 2" firm foam system, rounded corners, adjustable height leg system, four field feet, face rest and standard carry case. In addition, this table offers a lightweight aluminum frame, 11-layer plywood base with finger-joint craftsmanship and auto-hold hinge system. The features on this durable table clearly position it as a leader in its market space.

- Load capacity: 600 lbs.
- 37 lbs. Table weight
- Lightweight aluminum frame
- Height range 24"-33"
- 11-layer plywood base
- Auto-hold hinge
- Rounded corners
- Dual end accessory ports, 8" on center
- 2" Firm foam cushion, black upholstery
- Removable field feet
- Black carry case
- Face rest and pillow

- 73"L x 30"W x 24-33"H, Includes Face Rest
- Pillow and Carry Case **1032808** \$634.66 ea.
- Optional Table Cart **1032809** \$74.99 ea.

ATHLETIC EDGE Options

Upholstery

- | | | | |
|---------------|-----------------|-----------------|----------|
| Royal Blue | Deep Phoenician | American Beauty | Dove |
| Imperial Blue | Forest | Lark | Charcoal |
| Blue Ridge | Black | Burgundy | Mocha |

Powder Coat

- | | | | |
|------------|----------|--------------|-------|
| Black | Navy | Forest Green | Brown |
| Light Gray | Red | Purple | White |
| Charcoal | Burgundy | Yellow | |
| Royal Blue | Green | Orange | |

Laminate

- | | | |
|------------------------|---------------------|-----------------------|
| Oak Laminate | Grey Laminate | Harbor Grain Laminate |
| Maple Laminate | Storm Grey Laminate | Espresso Laminate |
| Cherry Merlot Laminate | | |

Wood

- | | |
|----------|------------|
| Oak Wood | Maple Wood |
|----------|------------|

Cushion Branding

- | | | |
|-----------------------------------|-------------|-----------------------|
| | | |
| Logo Slip Cover (Lift Backs Only) | Deboss Logo | Color Edge Print Logo |

Hi-Lo Tables



Hi-Lo Electric Changing/Treatment Table with Rails

Versatile table has electric powered height adjustment for easy transfer and access.

- Top dimensions: 72" x 25"
- Height lifting range: 18"-37" (22"-41" with base installed)
- 44" long side rails extend 6½" above table top
- Upholstered with 34 oz. vinyl with antimicrobial/antibacterial protection
- 1½" firm density foam mattress for comfort
- Hands-free foot switch control operation
- Swivel locking casters for safety (table is not intended for transporting an occupant)
- Sturdy X-frame with 11-gauge steel tubing
- 120 V, 60 hz motor with 8' power cord

Upholstery Color	Item #
Black	1008133
Blue Ridge	1008134
Burgundy	1008135
Taupe	1008122
Dove Gray	24558
Forest Green	1008137
Graystone	1008138
Imperial Blue	1008139
Merlot*	1008140
Patina*	1008141
Cappuccino*	1008136
All Colors	\$2,115.00 ea.

Belt strap (must be ordered when table is ordered; it can not be added later)
 **24559** \$154.00 ea.

Optional Base: features 6" of clearance for a patient lift. When installed, height range is approximately 22"-41".

6" Clearance Base **1008162** \$73.00 ea.



Adjustable height from 32" to 42"

6 adjustable seat back positions that lock in place



Both the electric motor and hydraulic pump tables can easily lift a 400-pound athlete



Electric



Hydraulic

Hi-Lo Taping Table with Adjustable Back

Hi-lo design is a first for training room taping table. This unique design will help alleviate shoulder and back strain as it accommodates users of almost any height.

Features:

- Electric motor or hydraulic pump easily lifts a 400-pound athlete
- Hydraulic pump design allows table to be used anywhere in a facility
- Taping table in lowest position allows athlete with painful injury to easily access the table
- Storage shelf keeps taping supplies easily accessible
- Adjustable from 32"-42"
- 6 adjustable seat back positions that lock in place
- 1½" heavy density foam
- Thick walled steel tubing provides extra structural strength
- Solid rubber, ball bearing wheels allow for easy portability
- All bolts are heavy-duty steel shoulder bolts
- Heavy-grade vinyl with antimicrobial coating
- 18-month warranty

Color	Electric	Hydraulic
Black	1007942	1007953
Blue Ridge	1007954	1007943
Burgundy	1007944	1007955
Taupe	1007952	1007963
Dove Gray	1007946	1007957
Forest Green	1007947	1007958
Graystone	1007959	1007948
Imperial Blue	1007949	1007960
Merlot*	1007961	1007950
Patina*	1007962	1007951
Cappuccino*	1007956	1007945
All Colors	\$1,719.99 ea.	

*Decorator Colors have an ultra soft leather feel and soft hi-loft backing

Hi-Lo Tables & Exam Tables



Ritter® 204 Manual Exam Table

18-gauge steel shell and reinforced seat to support patient, also prevents breakage. Comfort designed stirrups help make the lithotomy position a little easier for your patients. Features multi-density foam top design and powder-coated paint finish.

Available color choices: Dusty Blue, Moss, Navy, Perfect Plum, Shadow
 *24360 \$2,237.00 ea.



Oakworks ProLux PT300

Aluminum base and Tufflex upholstery. Crescent Face Pad can be reversed to support both prone and supine positioning. Please specify table width and color when placing order.

Available color choices: Black, Coffee Cream, Royal Blue, Spruce
 Available in 27", 29", and 31" Widths (31" width is an additional \$80.00)
 Weight Capacity: 550 lbs.
 Height Range: 18"-34", Length: 73"

..... *24358 \$2,219.99 ea.

ADA and Bariatric Color Options:

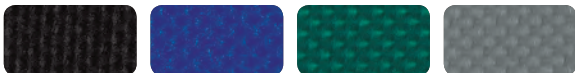

Black Blue Green Grey



ADA Hi-Lo Power Plinth Table

- Bariatric 600 lb. lift capacity
- Motorized table lowers to 20" for wheelchair transfer; elevates up to 30" high
- Electrically activated hydraulic cylinders are built into four corner telescoping legs
- Legs are black powder-coated and equipped with levelers for uneven floors
- Sturdy, black, powder-coated, steel frame with black laminate storage shelf
- Hands-free foot control operation
- Vinyl upholstered tops with 2" high-density urethane foam
- 110 V, 60 Hz, 2.4 amps

Weight Capacity: 600 lbs.

72"L x 30"W x 20"-30"H *24847 \$3,504.99 ea.



Bariatric Electric Mat Platforms

- Extremely stable lift system can easily lift up to 750 lbs. from 20" wheelchair height to 30"H
- Hydraulic cylinders are built into each four corner steel legs
- Seamless, nylon-reinforced vinyl is tear resistant
- 2" high-density urethane foam top
- Steel frame is durable black powder-coated finish
- Legs have levelers for uneven floors
- Electrically activated hydraulic cylinders are built into each four corner steel legs
- Motorized power height adjustment
- Hands-free foot control operation

Weight Capacity: 750 lbs.

7'L x 4'W x 20"-30"H *24848 \$4,374.99 ea.

7'L x 5'W x 20"-30"H *24849 \$4,589.99 ea.

8'L x 6'W x 20"-30"H *24851 \$4,709.99 ea.

*Direct-ship item. Please allow 3-6 weeks for fabrication and delivery after all information has been submitted.

Exam Tables & Accessories



EarthLite® Portable Exam Table

Lightweight, yet strong enough to hold more than 2,300 lbs. It's everything you expect from a portable professional table, at an affordable price. High-density, 2" thick foam. Headrests are optional and outlets are at both ends.

Weight: 30 lbs.
 Size: 73"L x 30"W
 Adjustable Height Range: 23"-33"

Portable Exam Table with Adjustable Headrest and Black Carrying Case (Specify EarthLite Color).....	*24006	\$754.99 ea.
Adjustable Headrest (Specify EarthLite Color).....	*24009	\$136.99 ea.
Black Carrying Case.....	*24010	\$159.99 ea.

EarthLite® Treatment Table

Standard features include EarthLite's special 3/8" thick, three-layer foam system, rounded corners for better access and working ease. Headrest outlets are at both ends. Features a hardwood shelf.

Weight: 78 lbs., Size: 73"L x 30"W
 Adjustable Height Range: 23"-33"

Treatment Table (Specify EarthLite Color).....	*24013	\$989.99 ea.
With Optional Tilt Back (Specify EarthLite Color).....	*24014	\$974.99 ea.

EarthLite Colors

Upholstery coverings for EarthLite® tables feel soft and warm to the touch. Covering has superior abrasion resistance, is oil- and stain-resistant, and can be cleaned with alcohol or strong detergents.

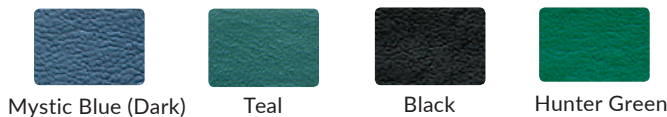

A

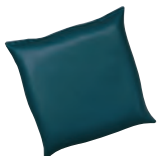

B



C



D



E

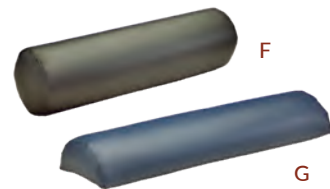

F

G

A. Dual-Wedge Leg and Knee Elevator

High-density urethane foam. Two vinyl-covered, foam wedges with Velcro® brand fasteners. Multifunctional wedge system assembles as a cube or in a variety of configurations.

.....	*24305	\$229.99 ea.
-------	---------------	--------------

B. Flat Pillow

14" x 14".....	*24054	\$37.50 ea.
----------------	---------------	-------------

C. Wedge Pillow

25" x 25" x 7", tapered to 1".....	*24106	\$81.80 ea.
------------------------------------	---------------	-------------

D. Patient Positioning System

- Offers superior comfort while positioning patients properly
- Larger vent areas for easier breathing and lower profile reduces excessive cervical extension/flexion
- Resilient platform provides optimal support for prone and supine positioning
- Easily cleanable and durable polymer platform
- Specify Black or Blue when ordering

.....	*24359	\$128.99 ea.
-------	---------------	--------------

E. Chattanooga Pron Pillo®

Elevates head and shoulders for added comfort. Raised base allows patients in prone position to breathe easier.

21" x 18" x 6".....	*24066	\$165.99 ea.
---------------------	---------------	--------------

School Health Brand Full- and Half-Round Pillows

Pillows are used as bolsters under the knees, ankles or neck to relieve muscle strain. Made from high-density urethane foam.

F. Half-Round Pillow, 3" x 6" x 26".....	*24291	\$48.99 ea.
-------------------------------------------------	---------------	-------------

G. Full-Round Pillow, 6" x 26".....	*24290	\$48.99 ea.
--------------------------------------------	---------------	-------------

Vinyl Liquid Patch, 1 oz.....	90068	\$7.90 ea.
-------------------------------	--------------	------------

Paper Roll Dispenser

With Plastic Band Cutter (for mounting under head)

.....	*24049	\$35.10 ea.
-------	---------------	-------------

Plastic Band Cutter Only.....	*24095	\$7.99 ea.
-------------------------------	---------------	------------

Fantastik® All-Purpose Cleaner

Perfect for Twill, Texhyde® and laminates.

32 oz.....	*34195	\$8.34 ea.
------------	---------------	------------

*Direct-ship item. Please allow additional time to receive.

Mobile Carts & Cabinets

Mobile Smart Cart Cabinet

- Maintenance-free laminated surfaces on all cabinet exteriors and interiors
- Top laminate surface: 17"W x 17½"D
- All cabinets have laminate edges
- High-impact polystyrene drawer interiors with rounded inside corners
- Two 5½" drawers and one 8½" deep drawer
- 4" Satin Finish wire drawer pulls
- 2½" twin-wheel hooded, swivel nylon casters

Weight Capacity: 180 lbs.
18½"L x 18½"W x 30"H

Oak *24643 \$629.99 ea.
Maple *24644 \$579.99 ea.



Proteam™ Mega Carts

- Maintenance-free laminated surfaces on all cabinet surfaces
- Top: 23"W x 18"D
- 3 mm PVC edging
- High-impact polystyrene drawer interiors and rounded inside corners
- 4" satin finish wire drawer pulls
- 2½" twin-wheel hooded, swivel nylon casters

Weight Capacity: 180 lbs.
24½"W x 18½"D x 32½"H



(1) 5½" Drawer, (2) hinged doors & (1) adjustable shelf

Oak *24631 \$629.99 ea.

Cherry..... *24632 \$629.99 ea.

(1) 5½" Drawer & (1) adjustable shelf

Oak *24629 \$589.99 ea.

Cherry..... *24630 \$589.99 ea.

Single Door Storage Cabinet

- All laminate, dowel and glue wood construction; shipped fully assembled
- Easy-to-clean laminate on all exterior and interior surfaces
- One door and five adjustable shelves
- Durable, five knuckle institutional hinges
- Adjustable laminate shelves
- Satin finish wire pulls
- Optional lock available

Weight Capacity: 300 lbs.
24"W x 23"D x 76"H

Oak *24640 \$1,299.99 ea.

Gray..... *24642 \$1,299.99 ea.



A

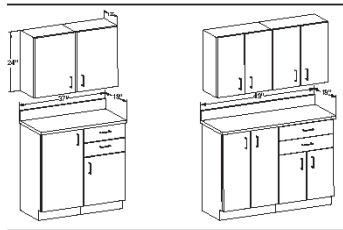

B

C

Pro-Line Professional Cabinets

- An economy line of modular, all-laminate, dowel-and-glue cabinetry
- Neutral color, all-laminate interiors
- All cupboards (except sink) have one adjustable laminate shelf
- 4" Satin finish wire pulls
- Self-closing laminate drawer slides, with nylon rollers and positive stops

A. (1) B-24 (24"W x 36"H x 18"D)
..... *24637 \$1,599.99 ea.

B. (1) B-18-L (18"W x 36"H x 18"D),

(1) B-18-2D-R (18"W x 36"H x 18"D) and

(2) W-18-24 (18"W x 24"H x 12"D)

..... *24638 \$1,689.99 ea.

C. (1) B-24 (24"W x 36"H x 18"D),

(1) B-24-2D (24"W x 36"H x 18"D) and

(2) W-24-24 (24"W x 24"H x 12"D)

..... *24639 \$1,949.99 ea.

- Doors have concealed, self-closing, 110° three-way adjustable euro-hinges
- Natural, Oak laminate on exposed cabinet surfaces including sides
- Specify Folkstone Gray square-edged top or choice of five others high pressure laminates countertop

Factory-Installed Options

Single Drawer or Door Lock *24517 \$56.99 ea.

Lock & Bolt for Double Doors *24518 \$104.99 ea.



Game Ready® Table

The Game Ready table is designed to hold two Game Ready units, and features three drying racks for Game Ready sleeves.

Oak

18.5" Wide *33084 \$694.00 ea.

24.5" Wide *33086 \$699.99 ea.

Black

18.5" Wide *33085 \$669.99 ea.

24.5" Wide *33087 \$699.99 ea.

*Direct-Ship Item. Please allow additional time to receive.

Mobile Carts & Accessories

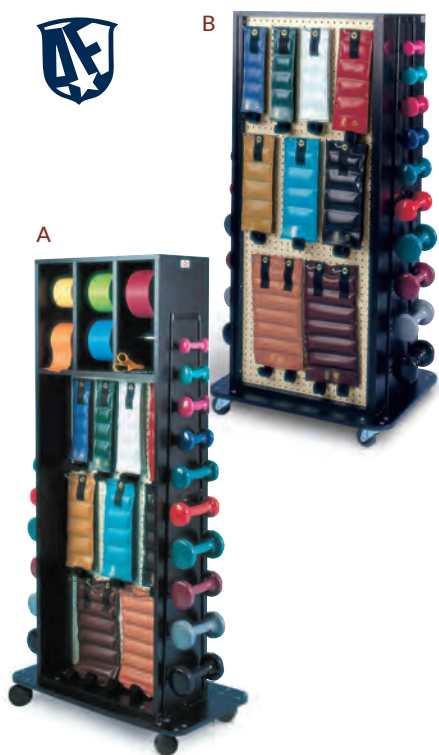

Multi-Purpose Racks

- Almond coated pegboard for 16 optional Hugger® weights; 11 pegboard safety hooks
- Ten dumbbell hooks on left side and 10 hooks on right side (total of 20 hooks); dumbbells are optional
- Durable Black laminate finish
- Base plate has bumper “T” molding on all four sides
- 3" diameter, swiveling, easy-rolling casters

A. Multi-Purpose Combination Rack

- Built-in dispensers for (5) REP Bands™
- Mirror with ANSI “shatter stop” safety backing.

Weight Capacity: 300 lbs.
30"W x 18"D x 72"H

..... *24843 \$1,044.99 ea.

With Accessories

- | | |
|---------------------------------|--------------------------------|
| (1) Rack | (5) REP Bands™ |
| (1) Set of (16) Hugger® Weights | (2) Sets of ten dumbbells each |

..... *24844 \$2,364.99 ea.

B. Multi-Purpose Weight/Storage Rack

- Two-door storage cabinet with lock.
- Doors have 165° self-closing Euro-hinges
- (2) adjustable shelves and (1) fixed shelf

Weight Capacity: 300 lbs.

30"W x 24"D x 61"H

..... *24845 \$1,089.99 ea.

With Accessories

- | | |
|---------------------------------|---------------------------------|
| (1) Rack | (2) Sets of (10) dumbbells each |
| (1) Set of (16) Hugger® Weights | |

..... *24846 \$1,714.99 ea.



ATHLETIC EDGE Stor-Edge™ Multi-Purpose Carts

Custom-built Stor-Edge Multi-Purpose Carts keep weights, resistance bands and other tools and equipment at hands' reach. Available in several model options, each is crafted of solid wood or laminate and is made in the U.S. The Stor-Edge Multi-Purpose Carts come in many different configurations for a variety of uses and sit on casters for ease and movability.

- | | |
|------------------------------------------|------------------------------------------------------|
| • Available in wood or laminate finishes | • Weight racks and J-hooks provided where applicable |
| • Full extension glides on all drawers | • 4" Heavy duty casters |
| • Black wire pull handles | • Cabinets ship fully assembled, except for casters |
| • 110° Euro hinges on doors | |

A. 30"W x 18"D x 72"H, Slatwall, Band Dispensers Weight Racks and Accessory Hook **1033071** \$984.99 ea.

B. 32"W x 32"D x 72"H, Cubby Storage, Drop Down Desk, (3) 8" Drawers, Band Dispensers, Slatwall, Weight Racks, Mirror and Accessory Hooks..... **1033099** \$2,174.99 ea.
Pricing shown is for Oak Wood.

*Direct-Ship Item. Please allow additional time to receive.



Rubbermaid® Heavy-Duty Utility Cart with Tray Top

Duramond™ construction for long, rugged wear without dents. No sharp edges which can nick or scrape walls and furniture. Casters for quiet maneuverability.

24" x 36" x 32¼"H

Maximum Capacity: 400 lbs.

Black *24441 \$376.50 ea.



Rubbermaid® Shelf Cart with Flat Top

Maximum Capacity: 400 lbs.

Black

19" x 38" x 33"H *24439 \$367.50 ea.

25½" x 44" x 33"H *24438 \$369.50 ea.



Stainless Steel Utility Cart

Hemmed smooth edges and rubber-tire casters with double-face ball bearings provide noiseless operation. Stain- and scratch-resistant. Shelves measure 15½" x 24". There is 13¼" between shelves.

16"W x 27½"D x 32¾"H

Weight: 26 lbs., Capacity: 300 lbs.

. *24012 \$328.00 ea.



3-Tub Shelf Utility Cart

Features tubs that are 2¾" deep. With 4" casters, two with locking brakes. Shelf clearance is 12".

Weight: 30 lbs.

24"W x 40½"H x 18"D

Black *24489 \$142.50 ea.

Gray (Shown) *24490 \$158.00 ea.



Rubbermaid® Instrument Cart

For transporting instruments and supplies. Large, quiet rolling, non-marking casters will not scratch floors. Lockable doors secure contents.

40⅝"W x 37⅜"H x 20"D

Weight Capacity: 300 lbs. (100 lbs. per shelf)

Gray *24197 \$713.00 ea.



Rubbermaid® Mobile Work Station

Offers the storage convenience of a supply chest with a large work surface. Heavy-duty 4" casters; dual lock for unit stability. Must ship via freight.

Capacity: 250 lbs.

32½"W x 33½"H x 19¾"D

Drawer sizes: One 1½"D, Two 3¼"D, Two 5½"D

Red/Black *24198 \$674.00 ea.

FREE SHIPPING at SchoolHealth.com/SportsMed

Get FREE SHIPPING on your online order over \$100! Go to the back cover for Free Ship Online code. Can only be used once per customer. Expires 12-31-20.

Screens & Lamps



Durable Three-Panel Screen

Flame-retardant, 6 mil. vinyl panels are light-weight and hinged. All steel frame. Easily converts from casters using crutch tips (included). Each panel is 27"W x 51"H.

Overall dimensions: 82"W x 69"H

White with Casters

.....**14000** \$237.00 ea.

Replacement Panel

.....**14015** \$28.50 ea.



Economical Three-Panel Screen

This three-panel screen can be opened to full width without zig-zagging. 3/4" tubing, 6 mil. flame-retardant vinyl. Each panel is 20" wide.

Overall dimensions: 60"W x 69"H

White**14016** \$243.50 ea.

Replacement Panel ...**14017** \$19.40 ea.

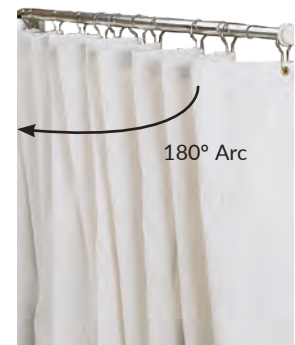

Telescopic Curtain

Wall mounted. The rod telescopes from 39" out to 90" and can be positioned anywhere within 180-degree arc. Curtain is made of 6 mil. flame-retardant vinyl.

Overall dimensions: 96" W x 72"H

White**14012** \$273.00 ea.

Replacement Curtain with Hooks

.....**14014** \$120.50 ea.



Ultraviolet Examination Lamp

Greatly assists in the observation and diagnosis of head lice and fungal infections. The two filtered black light tubes and two white light tubes, along with the 2" x 4", three-power magnification lens, make detection simple and thorough. Recommend screening in a dark room. (No UV eye protection needed).

.....***24078** \$653.00 ea.

Wall Bracket**24081** \$91.35 ea.

Replacement Bulb, White.....**24079** \$16.30 ea.

Replacement Bulb, Ultraviolet.....**24080** \$27.60 ea.



Dazor Portable Magnifiers

Dazor's lightweight hand-held magnifiers are the best choice for magnification "on-the-go". They are the perfect blend of abundant light and powerful magnification in a handy portable package.

Features:

- 2" diameter optical grade glass lens for clear and distortion-free viewing
- 10-diopter lens offers 2.5x magnification
- Convenient "kick-stand" for hands-free use
- Battery operated (four standard alkaline "AAA" batteries - not included)
- One year manufacturer warranty

24 White LED's..... **1005479** \$88.10 ea.

12 White LED's and 12 UV LED's..... **1005480** \$94.45 ea.

* Direct-ship item. Please allow additional time to receive.

SH School Health Brand Cubicle Curtain

Our curtains are available in two installed lengths: 82" and 90" (includes 2" hook length). To determine which length better suits your health room, measure the floor-to-ceiling height and subtract the curtain length. This will show you the remaining floor clearance. To decrease floor clearance for higher ceilings, drop chains are available (15"). **Hooks are included with track purchase.**

Each curtain length is available in four widths (68", 102", 136", and 170"). Ten percent must be added to total length of track(s) for curtain fullness. For example, a 10' total track length plus the prescribed 10% amounts to 132" (120"+12%=132"), in which case the 136" curtain is the best option.

Note: Length is the vertical dimension from floor-to-ceiling. Width measures left to right.

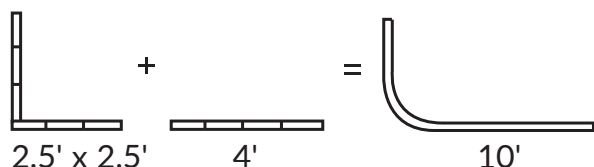

Ordering Curtain Tracks

Measure along the floor in the configuration of your choice. For a cubicle curtain that wraps around a recovery couch in an "L" shape, select one 90-Degree Bent Track, 3' x 3', and one 4' Straight Track to make an overall length of 120" (10 ft).

Supreme Cubicle Track (Includes hooks)

2' Straight Track	*14106	\$29.60 ea.
3' Straight Track	*14107	\$44.25 ea.
4' Straight Track	*14108	\$58.90 ea.
5' Straight Track	*14109	\$73.85 ea.
6' Straight Track	*14110	\$88.65 ea.
7' Straight Track	*14111	\$103.00 ea.
9' Straight Track	*14113	\$132.99 ea.
10' Straight Track	*14114	\$147.99 ea.
11' Straight Track	*14115	\$164.99 ea.

Bent Track (Includes hooks)

90 Degree		
2.5' x 2.5' Bent Track	*1005287	\$73.90 ea.
45 Degree		
2.5' x 2.5' Bent Track*	*1005286	\$74.10 ea.

Mounting hardware not included. Please measure carefully—each curtain and track is made to customer specifications and is therefore nonreturnable.

Make your health room look professional with attractive, functional and safe cubicle curtains from School Health. Our supreme cubicle tracks with hooks can be combined for a custom fit and look. Curtains are constructed of 100% Trevira polyester, antimicrobial and include 20" of mesh at top. They are fire-retardant for the life of the fabric and washable.

* Direct-ship item. Please specify color when ordering; allow 3-6 weeks for fabrication and delivery after all information has been submitted. Inspect shipments upon delivery.

Included in length is 2" Hook

68"W x 82"L	*14100	\$121.00 ea.
68"W x 88"L	*14101	\$121.00 ea.
102"W x 82"L	*14102	\$175.50 ea.
102"W x 88"L	*14103	\$175.50 ea.
136"W x 82"L	*14104	\$222.50 ea.
136"W x 88"L	*14105	\$222.50 ea.
166"W x 82"L	*14126	\$277.50 ea.
166"W x 88"L	*14127	\$277.50 ea.

Cubicle Curtain Color Choices*

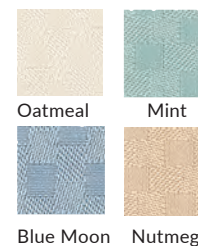

* Color swatches and additional color choices available upon request.

Cubicle Curtain Accessories

For higher ceilings, drop chains are available to decrease floor clearance. Hooks are included with the purchase of a cubicle track, but replacements are available. Three hooks per linear foot.

15" PVC Drop Chain	1035672	\$4.85 ea.
Replacement Hook	14022	\$3.48 ea.

**Questions about how to order?
Call Customer Care at 866-323-5465**

Chairs, Stools & Waste Cans



Stackable for easy storage!

Fabric Guest Chair

Fabric guest chair with arms stacks up to four high when not in use to maximize space. An upholstered seat and back give this chair a broad appeal at a compelling price.

Features:

- An unbeatable combination of versatility and value for any environment
- Polyester fabric is abrasion resistant
- Tubular steel frame stands up to frequent handling
- Contoured seat and back provide ergonomic support and comfort
- Chairs stack for quick and easy room rearrangement
- Fixed arms provide added comfort
- Perfect for waiting, lounge or lobby areas
- Padded seat and back provide a clean look that easily accommodates any existing aesthetic
- 5-Year Warranty

Black	1006902	\$105.00 ea.
Navy	1006903	\$105.00 ea.
Charcoal	1006904	\$105.00 ea.



A



B

A. Pneumatic Revolving Stool

Pneumatic foot control and wide base adjusts from 15" to 20½" with five casters. Some assembly required. Black.

.....	*24008	\$250.00 ea.
-------	---------------	--------------

B. Adjustable Stool

Features a welded tubular steel frame, 3" thick foam cushion and industrial-strength casters. Adjusts from 19" to 25". American made.

Black	24148	\$143.50 ea.
-------------	--------------	--------------



A



B

A. Kik-Step

Down-pressure on the stool causes the grip to "lock" to the floor as the easy-rolling casters retract.

Weight Capacity: 500 lbs.

Height: 14"

Gray	24016	\$129.99 ea.
------------	--------------	--------------

B. Foot Stool

Sturdy, all metal construction with tubular chrome-plated steel legs with a non-slip surface.

Size: 14"W x 11"D x 9"H	24015	\$64.70 ea.
-------------------------------	--------------	-------------



A



B

Steel Step-On Cans

Meets OSHA bloodborne pathogen standards. UL-listed, FM-approved fire safe. Germ Fighter[®] plastic liner provides potent biocide protection.

Uses 24" x 24" bags, 12" Square x 23"H

A. White, 12-Gallon.	24037	\$304.50 ea.
----------------------------------	--------------	--------------

Uses 30" x 44" bags, 15" Square x 30"H

B. Red, 24-Gallon	24085	\$425.00 ea.
--------------------------------	--------------	--------------

Disposables & General Supplies



Disposable Cups, Dispensers 340
Exam Paper & Linens 341
Sheets 341
Pillow Cases 341
Plastic Bags 342

Paper Towels & Exam Gowns 343
Facial Tissues & Feminine Hygiene 344
Sundry Jars & Linens 345
General Supplies 346-348

Disposable Cups, Dispensers



Buy a case and SAVE!

PAPER CUPS	Tube	Case
A. 3 oz. Flat Bottom Paper Cup	21209 100/tube \$5.70 tb.	1030741 5,000/case \$253.50 cs.
B. 3½ oz. Pleated Paper Cup	21013 100/tube \$4.62 tb.	1030749 2,500/case \$105.00 cs.
C. 4¼ oz. Cone-Shaped Paper Cup	21011 200/tube \$5.77 tb.	21399 5,000/case \$120.50 cs.
D. 5 oz. Flat Bottom Paper Cup	21010 100/tube \$6.50 tb.	1030649 2,500/case \$134.00 cs.
E. 7 oz. Gatorade® Paper Cup	21696 100/tube \$9.16 tb.	1030852 2,000/case \$130.00 cs.
F. 12 oz. Gatorade® Paper Cup	21100 100/tube \$9.31 tb.	21092 2,500 case \$162.50 cs.
G. 9 oz. Powerade® Paper Cup	1007042 100/tube \$6.75 tb.	21647 2,500 case \$110.00 cs.

Buy a case and SAVE!

PLASTIC CUPS	Tube	Case
J. 5 oz. Flat Bottom Plastic Cup	21012 100/tube \$4.22 tb.	1030644 2,500/case \$91.35 cs.
K. 5 oz. Yellow Plastic Cup	21233 100/tube \$5.69 tb.	21402 1,000/case \$46.25 cs.
L. 5 oz. Blue Plastic Cup	21231 100/tube \$5.69 tb.	21403 1,000/case \$46.25 cs.
M. 5 oz. Mauve Plastic Cup	21232 100/tube \$5.69 tb.	21404 1,000/case \$46.25 cs.
N. 5 oz. White Plastic Cup	21417 100/tube \$5.69 tb.	21407 1,000/case \$46.25 cs.
O. 3½ oz. Flat Bottom, Clear Plastic Cup	21418 100/ tube \$4.13 tb.	1030643 2,500/case \$88.80 cs.

MEDICINE CUPS	Tube	Case
H. 1 oz. Pleated Paper Medicine Cup	21095 250/tube \$4.86 tb.	21405 5,000/case \$85.70 cs.
I. 1 oz. Plastic Medicine Cup Measures: oz., mL, drams, T, tsp and cc's.	21004 100/tube \$2.05 tb.	1030744 5,000/case \$91.60 cs.

Cup Dispensers

P. Standard—Adjusts to fit paper and plastic cups on this page (excluding E, F, G, H and specimen containers).

..... **21000** \$29.00 ea.

Q. Stainless Steel—Adjusts to fit paper and plastic cups on this page (excluding E, F, G, H, 21417, 21418 and specimen containers).

..... **21210** \$42.50 ea.

Exam Paper & Linens



Exam Paper

This strong, absorbent table paper protects exam tables from dirt and moisture; disposable, single-use paper. Available in Premium or Economy, creped or smooth. Premium rolls are individually wrapped in plastic to protect during shipping and storing.

Buy a case and SAVE!

Premium Creped

	Roll	Case of 12
18" x 125'	21017	21413
	\$4.85 roll	\$67.65 cs.
21" x 125'	21016	21414
	\$4.88 roll	\$50.85 cs.

Premium Smooth

	Roll	Case of 12
18" x 225'	21038	21415
	\$6.16 roll	\$65.05 cs.
21" x 225'	21014	21416
	\$7.07 roll	\$73.85 cs.

Economy Creped

	Roll	Case of 12
18" x 125'	21158	1030647
	\$3.12 roll	\$38.65 cs.
21" x 125'	21159	1030746
	\$3.76 roll	\$42.10 cs.

Economy Smooth

	Roll	Case of 12
18" x 225'	21160	1030745
	\$4.42 roll	\$53.50 cs.
21" x 225'	21161	1030648
	\$5.03 roll	\$55.15 cs.

Buy a case and SAVE!

Poly-Perf Exam Paper Rolls (Not Shown)

Perforated for easy tearing, securely bonded to prevent soak-through and reduces risk of contamination.

	1-8 Rolls	Case of 9
18" x 125'	21150	\$10.95 roll \$10.57 roll
21" x 125'	21151	\$12.35 roll \$11.92 roll

Crepe Sheets (Not Shown)

18" x 24" Pre-Cut		
1,000/case	21425	\$90.20 cs.
20" x 30" Pre-Cut		
1,000/case	21426	\$107.00 cs.

GO-TO

Go to pages 320-332 for couches & tables

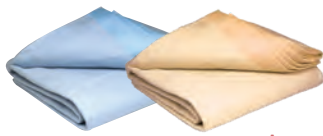

A

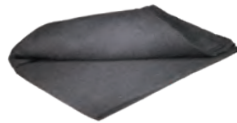

B



C



D



E



F



G



H



I



J

Blankets

A. Thermal Blankets

Fits twin or double bed.

66" x 90"		
Blue	48001	\$31.55 ea.
Tan	48015	\$31.55 ea.

B. Wool Blanket

62" x 84"		
Gray	48016	\$59.99 ea.

C. Sheet Blanket, Naplite Cotton

72" x 90"		
Beige	48006	\$24.00 ea.

Disposable Blanket

With waterproof yellow poly film.

60" x 90"	21032	\$8.74 ea.
---------------------	--------------	------------

Sheets

D. Kimlon Sheets, Disposable

By Kimberly-Clark.

60" x 96"		
12/pkg	21020	\$64.10 pkg.

E. Drape Sheets, Disposable

40" x 72"		
50/case	21045	\$36.50 cs.

Pillows

F. Pillow, 20" x 27"

Dacron **48002** \$16.30 ea.

G. Pillow, Fluid-Proof Ovation™

This reusable pillow is fluid-proof, even under the most demanding conditions.

. **48019** \$18.85 ea.

Pillow Cases

Economy Plastic Pillow Case, Zippered

21" x 27" **48020** \$8.99 ea.

H. Plastic Pillow Case, Zippered

21" x 27" **48008** \$10.99 ea.

I. Tissue/Poly Pillow Cases

Poly-back, 21" x 29"

Blue, 100/case **21187** \$47.85 cs.

Kimlon Pillow Cases, Disposable

By Kimberly-Clark.

20" x 29"

25/pkg **21006** \$34.15 pkg.

Towels

J. Terry Bath Towel

100% cotton, extra absorbent.

22" x 44"

White **48009** \$5.67 ea.

24" x 50"

White **48007** \$9.36 ea.

Terry Washcloths

12" x 12"

12/pkg **48011** \$12.50 pkg.

Economy Bath Towels

15" x 25"

White, 12/pkg **48021** \$15.10 pkg.

Plastic Bags



OdorNo Waste Disposal Bags

- Multi-layer waste disposal bags
- Environmentally friendly, compostable and biodegradable
- Ideal for babies, incontinence and feminine hygiene products
- Perfect in healthcare or daycare environments
- Constructed of FDA approved plastics; does not contain powders or perfumes

2 Gallon, 25/box.....**.21724** \$17.45 box



Less than 1 cent per bag. Compare to Baggies® Brand!

Ziploc® Sandwich Bags

	1-11 Boxes	Case of 12
Pint 6½" x 5¾", 1.5 mil.		
A. 40/box... 1003748	\$4.66 box	\$4.50 box
B. 90/box... 1003749	\$5.65 box	\$5.45 box
6½" x 3¾", 1.5 mil.		
90/box..... 21220	\$5.90 box	\$5.69 box
Quart C. 7" x 8", 1.75 mil.		
500/box..... 21595	\$54.65 box	—
Gallon 10⅝" x 11", 1.7 mil.		
D. 19/box..... 21356	\$4.80 box	—
E. 10⅝" x 11", 1.75 mil., Double Zipper		
250/box..... 21593	\$46.05 box	—

Ziploc® Freezer Bags

	1-11 Boxes	Case of 12
Pint 7" x 5¾", 2.7 mil.		
20/box..... 21114	\$5.07 box	\$4.89 box
Quart 7" x 8", 2.7 mil.		
40/box..... 21003	\$9.55 box	\$9.22 box
Gallon 10⅝" x 11", 2.7 mil.		
30/box..... 21133	\$8.75 box	\$8.44 box
F. 10⅝" x 10¾", Double Zipper		
250/box..... 21594	\$51.45 box	—

School Health Brand Ice Bags

10" x 18", 1 mil., 1,500/roll	.21633	\$104.00 roll
Clear Acrylic Heavy Duty Dispenser	.91454	\$151.00 ea.



Baggies® Storage Bags

Quart Size	1-23 Boxes	Case of 24
6⅞" x 8"		
80/box..... 21039	\$3.21 box	\$3.10 box
150/box..... 21068	\$4.52 box	\$4.36 box
Gallon Size 11½" x 12½"		
50/box..... 21054	\$6.31 box	\$6.09 box



Cramer® Ice Bags

Heavyweight 9½" x 18", 1 mil.
1,500/roll.....**21144** \$124.99 roll

ELINE Ice Bags

12" x 20", 2 mil.
1,000/case.....**21218** \$114.00 cs.

Ice Bags

8" x 18", 0.038 mil.
100/box..... **21031** \$51.99 box

8" x 4" x 18", 1.25 mil.
1,000/case.....**21115** \$82.80 cs.

Zipper® Seal-Top Reclosable Bags

These seal-top reclosable bags are all-purpose storage bags that are available in 2 mil. and 4 mil. thicknesses. 2 mil. bags are also available with writing blocks. Perfect for storing students' medications.

2 mil. Clear Bags, 100/pkg.		
3" x 3"..... 21337		\$1.65 pkg.
4" x 4"..... 21338		\$2.54 pkg.
4" x 6"..... 21422		\$2.72 pkg.
5" x 7"..... 21339		\$3.44 pkg.
5" x 8"..... 21389		\$4.16 pkg.
6" x 8"..... 21390		\$4.75 pkg.
6" x 9"..... 21340		\$5.44 pkg.
7" x 8"..... 21388		\$8.16 pkg.
8" x 10"..... 21391		\$9.36 pkg.
12" x 12"..... 21392		\$12.10 pkg.
2 mil. Clear Bags with Writing Block, 100/pkg.		
3" x 5"..... 21344		\$2.57 pkg.
4" x 6"..... 21345		\$4.02 pkg.
5" x 8"..... 21346		\$5.93 pkg.
6" x 9"..... 21347		\$7.05 pkg.
4 mil. Clear Bags, 100/pkg.		
4" x 4"..... 21341		\$4.34 pkg.
6" x 6"..... 21342		\$9.03 pkg.
6" x 9"..... 21343		\$10.45 pkg.

Not made with Natural Rubber Latex.

Paper Towels & Exam Gowns



A



B



Best Value!

C



D



E



F

A. C-Fold/Multi-Fold Towels

These towels are the perfect choice when economy is required in a folded towel system. Classic towels combine the right balance of quality and cost-effectiveness to deliver high value.

C-Fold, 150/pkg., 2,400/case	21135	\$66.15 cs.
Economy Multi-Fold, 250/pkg., 4,000/case.	21423	\$61.20 cs.

B. Quick View C-Fold/Multi-Fold Towel Dispenser

Clean, modern appearance compliments all decors. Opaque cover allows for "at a glance" inspection for refills. Hides scratches and maintains image. Smooth cover with no recesses is easy-to-clean and maintain. Only touch the paper you need.

.....	90967	\$58.85 ea.
-------	--------------	-------------

C. Value Price Paper Towels

3-ply, 13½" x 18"		
500/case.	21219	\$31.10 cs.

D. Disposable Washcloths

500/case 	48030	\$44.50 cs.
Contains natural rubber latex, 10" x 13½"		
500/case.	21043	\$42.90 cs.

E. Crosstex Professional Towels

These towels function like a dentist's drip cloth and can even be used over pillows. 3-ply.

13" x 19", 500/case	21042	\$33.35 cs.
---------------------------	--------------	-------------

F. Clear Acrylic Towel Dispenser

For use with Crosstex Towels.

.....	90088	\$29.38 ea.
-------	--------------	-------------



Rest Assured Toilet Seat Covers

20 packages of 250		
5,000/case.	21148	\$105.00 cs.
Toilet Seat Cover Dispenser		
.....	22009	\$18.75 ea.



A



B

A. Disposable Exam Gowns

Disposable capes open in both front and back.

30" (unopened) x 22", Blue		
100/case.	21046	\$41.35 cs.
30" x 44", Blue		
50/case.	21047	\$41.60 cs.

B. Exam Bibs

Poly-backed with ties.

30" x 18", White		
150/case.	21143	\$32.25 cs.

Not made with Natural Rubber Latex.

Facial Tissues & Feminine Hygiene

Buy a Case and SAVE!



A. Kleenex® Classic Facial Tissue

Classic White, 2-ply Facial Tissue

100/box	21600	\$2.65 box
125/box	21296	\$2.99 box
160/box	1034296	\$3.52 box

Buy a Case and Save!

100/box, 36/case.	1030642	\$70.45 cs.
160/box, 36/case.	1034297	\$116.00 cs.

B. Pocket Tissues

15 count packs, 2-ply tissues.		
10/pkg.	21516	\$4.81 pkg.

C. Value-Priced Tissues, 2-ply

144/box	21212	\$2.35 box
-------------------	--------------	------------

Buy a Case and Save!

144/box, 36/case.	1030646	\$72.25 cs.
---------------------------	----------------	-------------

D. Economy Tissues, 2-ply

100/box	21041	\$1.33 box
-------------------	--------------	------------

Buy a Case and Save!

100/box, 30/case.	1030645	\$36.25 cs.
---------------------------	----------------	-------------



A. Naturelle® Plus Maxi Pads

Individually packaged.. Size: 3" x 4¼" x 1½", #4

250/case.	22003	\$77.90 cs.
-------------------	--------------	-------------

B. Naturelle® Maxi Pads

Individually packaged. Size: 8" x 3¼" x 7/8", #8

250/case.	22002	\$89.95 cs.
-------------------	--------------	-------------

C. Naturelle® Napkin/Tampon Economy Pack

For smaller volume facilities when storage space is limited. 50 Naturelle® Tampons, 50 Naturelle® Maxi Pads #4.

100/case.	22006	\$76.50 cs.
-------------------	--------------	-------------

Naturelle® Panty Shields (Not Shown)

Individually packaged, 200/case.

	22008	\$80.15 cs.
--	--------------	-------------

Sanitary Maxi Pads w

Individually packaged, 12/pkg.

	22230	\$4.12 pkg.
--	--------------	-------------

D. Tampax® Tampons

Flushable applicator.

40/box	22010	\$15.00 box
------------------	--------------	-------------

E. Tampax® Super Plus Tampons

Flushable applicator.

40/box	22035	\$15.15 box
------------------	--------------	-------------

Economic Cardboard Sleeve Tampons (Not Shown)

200/case.	22055	\$85.20 cs.
-------------------	--------------	-------------

F. Always® Thin Ultra Maxi Pads

It has a soft, cotton-like Dri-Weave™ that is softer than ever and helps provide clean, dry protection. Individually wrapped.

With Wings

36/pkg	22029	\$13.90 pkg.
------------------	--------------	--------------

G. Kotex® Tampons

18/box		
Regular	22049	\$8.33 box
Super.	22050	\$8.33 box
Super Plus	22051	\$8.33 box

H. Kotex® Maxi Pads

24/pkg.		1-11 pkgs.	Case of 12
.	22011	\$7.69 pkg.	\$7.42 pkg.
Thin, 22/pkg.			
.	22036	\$7.69 pkg.	\$7.42 pkg.

I. Dual Pad/Tampon Vending Machine

Double lock on door. Holds Naturelle Pads (22003), Naturelle Tampons (22006) and Naturelle Shields (22008).

10½"W x 5½"D x 30¾"H, Weight: 21 lbs. with ADA Handle

.	*22001	\$455.50 ea.
-----------	---------------	--------------

* Direct-ship item. Please allow extra time to receive. Inspect shipments upon delivery.



A. Acrylic Sundry Jars, Labeled

Polystyrene clear jars with lettering. Labels on the five jars read: applicators, bandages, cotton, gauze and tongue depressors.

5 Large Jars (6½"H x 4"D)
.....46013 \$37.05 set

B. Acrylic Jars, Unlabeled

Polystyrene clear jars without lettering. Perfect for all your pharmacy products. Products in jars not included.

Set with 2 Small & 1 Large Size Jars

2 Small Jars (4½"H x 4"D), 1 Large Jar (6½"H x 4"D), 1 Rack (14½"L x 6"W)
.....46007 \$73.25 set

Individual Jars

Small Jar (4½"H x 4"D)
.....46002 \$13.25 ea.

Large Jar (6½"H x 4"D)
.....46006 \$15.75 ea.

C. Glass Sundry Jars, Labeled

Stainless steel covers.

7"H x 4¼"D.....46008 \$62.30 set

D. Glass Sundry Jars, Unlabeled

Stainless steel covers.

6"H x 6"D.....46051 \$28.50 ea.

5"H x 5"D.....46052 \$26.45 ea.

4"H x 4"D.....46053 \$23.55 ea.

3"H x 3"D.....46054 \$16.90 ea.

7"H x 4¼"D.....46050 \$14.90 ea.

E. Glass Vials

6 Dram.....46069 \$2.02 ea.

9 Dram.....46071 \$2.22 ea.

F. Amber Jars with Dropper

1 oz.....46066 \$2.31 ea.

2 oz.....46067 \$3.62 ea.

4 oz.....46068 \$3.95 ea.

G. Thick Jar

8 oz.....46065 \$7.87 ea.

H. Plastic Bottles

4 oz.....90596 \$3.99 ea.

6 oz.....90597 \$2.99 ea.

I. Jars

2 oz.....46057 \$1.77 ea.

4 oz.....46058 \$2.70 ea.

8 oz.....46059 \$3.28 ea.

12 oz.....46060 \$3.24 ea.

16 oz.....46061 \$3.52 ea.

32 oz.....46062 \$4.44 ea.

J. Polyethylene Bottles

8 oz.....90076 \$2.85 ea.

16 oz.....90077 \$4.02 ea.

K. Alcohol Dispenser

8 oz.....90009 \$14.15 ea.

L. Graduated Bottles and Trigger Sprayer

The ergonomic shapes make the bottle easy to handle. Plain white bottle design, ready for your secondary labels. Trigger sold separately.

24 oz. Graduated Bottle
.....91244 \$1.25 ea.

32 oz. Graduated Bottle
.....91245 \$1.25 ea.

Trigger Spray.....91246 \$1.25 ea.

General Supplies



A

A. 3M® Surgical Clipper

Use to remove hair safely, quickly and thoroughly prior to taping. A cordless, rechargeable, battery-operated clipper. The charger is built into the body of the clipper itself.

.....	.90110	\$184.50 ea.
Dispenser Blade Assembly.....	.90111	\$10.00 ea.

B. Wahl Hair Clipper

Powerful clipper features sturdy construction and professional styling. Includes a blade, adjustable blade control, four attachment combs, barber comb, trim comb, shears, cleaning brush, blade guard, oil and an instructional video.

.....	.90006	\$44.99 ea.
-------	---------------	-------------

Prep Shaver Kit

50/box90945	\$34.25 box
--------------	---------------	-------------

Razor, Double Edge

.....	.90944	\$0.13 ea.
-------	---------------	------------



B



C

C. Cramer® Firm Grip

Alleviates sweaty hands. Put a light coating on hands and fingertips to provide an excellent grip and feel. Natural rosin formula.

4 oz. Spray50039	\$15.15 ea.
-------------------	---------------	-------------



D

D. Mueller Magic Grip

Grip enhancer repels water and sweat by keeping hands and gloves dry. Legal for use in the NCAA and high school play. Used by the pros. Magic Grip is not sticky or tacky.

3 oz. Spray50108	\$10.50 ea.
-------------------	---------------	-------------

A

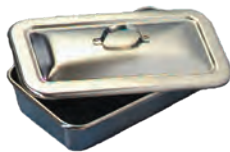

B



C



D



E



F



G



H



Covered Instrument Tray

A. Stainless Steel 12 3/8" L x 7 5/8" W x 2 1/2" H46025	\$111.50 ea.
--------------------------------------------------------------------	---------------	--------------

Deep Solution Basins

B. Stainless Steel, 7 Quart46024	\$120.50 ea.
C. Polypropylene, 7 Quart46016	\$22.40 ea.

Emesis Basins

D. Stainless Steel, 8 1/8" Long46028	\$52.35 ea.
E. Economy Plastic, 8 1/4" Long46000	\$3.74 ea.
Economy Plastic, 10" Long46010	\$3.69 ea.
Polypropylene, 8 1/2" Long46018	\$8.65 ea.
F. Polypropylene, 10" Long46019	\$5.99 ea.

Forceps/Thermometer Jars

G. Polypropylene, 2 1/4" W, 4 1/2" D46020	\$21.10 ea.
---------------------------------------------------	---------------	-------------

Wash Basins

H. Economy Plastic, 7 Quart46014	\$6.63 ea.
Polypropylene, 5 Quart46015	\$15.05 ea.

A. Mueller® Stealth™ No Glare® Glare Reducing Strips

Stealth™ No Glare® strips feature state-of-the-art materials that blast light in different directions—most of it away from the eye. Mueller Stealth reflects 86% less light compared to competing brands.

No Logo, 72/pkg.	91546	\$21.35 pkg.
No Logo, 144/pkg.	91545	\$26.65 pkg.
Pink, No Logo, 36/pkg.	91547	\$7.65 pkg.



A



B

B. Mueller® No Glare® Glare-Reducing Stick

Black paste for application to cheekbones just below eyes of athletes to reduce glare on bright days.

0.65 oz.	90659	\$7.37 ea.
---------------	--------------	------------

C. GameDay EyeBlack

Reduces glare. Not messy and is easy to apply. Note that each unit can be used only once.

12 pair/pkg.	90882	\$7.94 pkg.
-------------------	--------------	-------------



C

D. ADANAC Eight-Lap Stopwatch

Capable of eight lap times. Memory recalls up to 99 laps/each. Countdown timer, for up to 10 hours, with a 30-second shuttle timer for "time-outs". Shock and water-resistant with a 46" lanyard.

.....	90421	\$46.25 ea.
-------	--------------	-------------

E. ADANAC Digital Stopwatch

Water-resistant. Displays minutes, seconds and 1/100th seconds. Times both single and split events. Includes time-out mode timing and has separate start/stop and reset features. Complete with 46" lanyard.

.....	90420	\$18.55 ea.
-------	--------------	-------------

F. Clip-On Timer

Our most popular model.

2½" x 2" x ½".	90429	\$23.65 ea.
---------------------	--------------	-------------



D



E



F



NEW!

CatTongue Grips Non-Abrasive Grip Tape Roll

Thousands of Grippy Uses!

CatTongue Grips Non-Abrasive Utility Grip Tape allows anyone to customize any space or any thing in which they need to get a grip on and remove slippery surfaces.

10'L x 2"W.	1035304	\$19.99 ea.
------------------	----------------	-------------

General Supplies



A



B

A. Mag-Lite Adjustable Beam Flashlights

With 2 "D" Batteries	90010	\$36.50 ea.
With 2 "C" Batteries	90031	\$36.99 ea.
With 2 "AA" Batteries.	90001	\$20.99 ea.
With 2 "AAA" Batteries & Pocket Clip.	90089	\$18.99 ea.
With 1 "AAA" Battery	90090	\$12.99 ea.

Replacement bulbs for Mag-Lites available on our website.

B. Pelican VB3 LED Light

A quick and easy, hands-free light source for night games! Pivots to a full 180° for aiming light where you need it. The built-in clip attaches to surfaces up to ½" thick. 10,000 hours of lamp life, built tough for outdoor use, super-bright LED beam.

.	1006657	\$27.99 ea.
-----------	----------------	-------------



Tacki-Mat

Effectively removes dirt from shoes and equipment wheels. The non-transferring adhesive locks onto the dirt and captures it. Simply peel it off to expose a clean layer. Easy-to-use, long lasting and cost effective.

Frame with 40 sheets24469	\$249.99 ea.
Refill with 40 sheets24470	\$99.99 ea.



Energizer® Alkaline Batteries (Mercury-Free)

9 Volt	90072	\$6.99 ea.
Size "AAA", 2/pkg.	90037	\$4.99 pkg.
Size "AA", 2/pkg	90036	\$4.99 pkg.
Size "C", 2/pkg.	90034	\$8.49 pkg.
Size "D", 2/pkg.	90035	\$8.49 pkg.

Duracell® Procell Alkaline Batteries

- Mercury free
 - Economical bulk packaging saves money
 - Date coded to guarantee freshness
- | | | |
|----------------------|--------------|------------|
| 9 Volt | 91265 | \$4.01 ea. |
| Size "AAA" | 91261 | \$1.61 ea. |
| Size "AA" | 91262 | \$1.61 ea. |
| Size "C" | 91263 | \$2.53 ea. |
| Size "D" | 91264 | \$2.53 ea. |

Industrial Alkaline Batteries

Sold individually, without cost of retail packaging.

9 Volt	90283	\$4.62 ea.
Size "AAA"	90284	\$1.74 ea.
Size "AA"	90285	\$1.74 ea.
Size "C"	90286	\$2.60 ea.
Size "D"	90287	\$2.60 ea.

Educational Aids & Resources



Reference Materials & Anatomical Models 350
Posters & Charts 351

Concussion Management Solutions for Students . . . 352
Training Manikins 353-355

Reference Materials & Anatomical Models

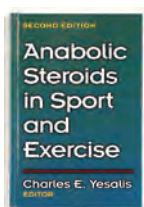

A



B



C

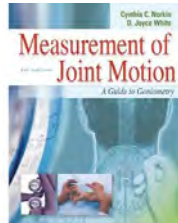

D



E



F

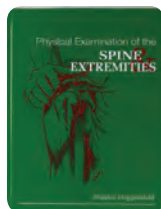

G

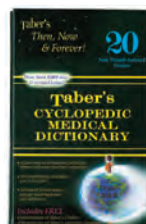

H

A. Anabolic Steroids in Sports And Exercise, 2nd Ed.

Written by Charles E. Yesalis. Comprehensive text on steroid use in athletics. Looks at the history, effects and societal issues of steroid use. ©2000
512 pages..... **11087** \$104.00 ea.

B. Basic Athletic Training Manual, 5th Ed.

Updated text provides comprehensive beginner and intermediate-level instruction on the principles of sports medicine and athletic training. Software includes all new anatomical animations, as well as quizzes designed to test knowledge based on information contained in the text and software. Written by Drs. Kenneth Wright and William Whitehill, ATC.

..... **11160** \$56.65 ea.

C. Emergency Care and Transportation of the Sick and Injured

Easy-to-read and fully illustrated. Features 400 new medical photos. ©2010
1,584 pages..... **11013** \$149.50 ea.

D. Measurement of Joint Motion: a Guide to Goniometry

Student manual provides comprehensive coverage of the subject and includes extensive use of halftone photographs. This edition is consistent with the APTA's Guide to Physical Terminology. ©2009

448 pages..... **11043** \$66.80 ea.

E. The Merck Manual, 19th Ed.

Covers most diseases and their treatments. Thumb index included. ©2011

3,754 pages..... **11006** \$121.00 ea.

F. PDR® Guide to Drug Interactions – Side Effects and Indications, 2010 Ed.

Interaction index alerts you to every combination. Side effects index lets you look up signs, symptoms and abnormalities. Keyed to the official FDA prescribing information in the PDR. ©2009

2,580 pages..... **11047** \$119.00 ea.

G. Physical Examination of the Spine and Extremities

By Stanley Hoppenfield. Includes over 600 constructive illustrations. ©1976

276 pages..... **11033** \$182.50 ea.

H. Taber's Cyclopedic Medical Dictionary, 22nd Ed.

Definitions about anatomy, disease and physical disorders, often accompanied by drawings. ©2009

2,846 pages..... **11005** \$55.90 ea.



Taping Methods Video Textbook DVD By Ron O'Neil, ATC

35 step-by-step taping techniques are great for use as a class supplement. Includes preventative and post-injury taping instruction, taping techniques for ankle and lower leg, knee, upper extremity and more, and auxiliary applications (including wound care). Techniques detailed by Ron O'Neil, a certified AT for 37 years—29 of those years with the NFL.

DVD..... **16135** \$41.95 ea.



Concussion Education: In the Student-Athlete's Neighborhood

Phil Hossler, ATC. When any athlete sustains a sports concussion, sensitive, trained and compassionate neighbors are needed to monitor the athlete's recovery. For student-athletes, this managing team or neighborhood includes coaches, athletic trainers, parents, physicians, teachers, school nurses and school psychologists, along with concussion specialists. This tip card provides checklists and practical strategies on educating everyone on the signs and symptoms of concussion in student-athletes, with tips for support and accommodations.

..... **11759** \$3.65 ea.

ANATOMICAL MODELS



Full-Size Human Skeleton with Skeletal System Chart

Full-size male skeleton stands 5' 6" tall and is made of plastic, cast from actual bones. With all 200 bones fully articulated, this model has joint movement! Pelvic-mounted support stand is on wheels. Comes with a laminated 22" x 28" Skeletal System Chart and dust cover.

..... **12135** \$558.50 ea.



Musled Knee Model

Full-size, normal right knee includes: rectus femoris, vastus lateralis and vastus medialis muscles, femur, fibula, patella and tibia bones, anterior cruciate ligament and quadriceps femoris tendon, plus six more ligaments and tendons.

3½"W x 10"H x 3"D

..... **12584** \$157.50 ea.



Functional Shoulder Joint Model

Illustrates abduction, adduction, anteversion, retroversion and internal/external rotation.

6½" x 5" x 8"..... **12078** \$165.50 ea.



Anatomy Posters

Lithographed in four colors with striking three-dimensional effects, and presented in a pleasing and refreshing style with explanatory nomenclature. Details to satisfy the most exacting healthcare professional in a clear composition for the beginning student.

Size: 20"W x 26"H

Anatomy and Injuries of the Hip	12152	\$32.25 ea.
Endocrine System	12115	\$32.25 ea.
Head & Neck	12097	\$32.25 ea.
Maintaining a Healthy Weight	12552	\$32.25 ea.
Nervous System	12007	\$32.25 ea.
Pregnancy & Birth	12096	\$32.25 ea.
Sexually Transmitted Diseases	1006916	\$32.25 ea.

Size: 22"W x 28"H

Brain	12016	\$12.10 ea.
Digestive System	12013	\$12.10 ea.
Ear	12015	\$12.10 ea.
Eye	12014	\$12.10 ea.
Female Reproductive System	12011	\$12.10 ea.
Foot & Ankle	12542	\$12.10 ea.
Hand & Wrist	12521	\$12.10 ea.
Heart	12017	\$12.10 ea.
Hip & Knee	12541	\$12.10 ea.
Kidney	12069	\$12.10 ea.
Male Reproductive System	12010	\$12.10 ea.
Muscular System	12005	\$12.10 ea.
Shoulder & Elbow	12551	\$12.10 ea.
Skeletal System	12004	\$12.10 ea.
Skin	12068	\$12.10 ea.
Teeth	12067	\$12.10 ea.
Understanding Middle Ear Conditions	12062	\$12.10 ea.
Vascular System & Viscera	12006	\$12.10 ea.
Vertebral Column Spine Disorder	12159	\$12.10 ea.



A

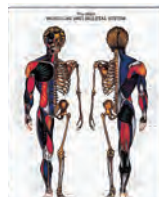

B

Muscular and Skeletal System Charts

Laminated charts with metal eyelets in top corners.

24"W x 32"H

A. Female	12110	\$17.80 ea.
B. Male	12518	\$17.80 ea.

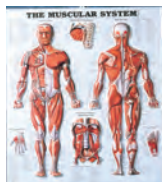

Anatomical Injection Molded Charts

Life-like, three-dimensional appearance. Hole at the top for wall hanging.

18"W x 22½"H

Muscular	12070	\$33.35 ea.
----------------	--------------	-------------



Portable Chart Stand

28"W x 53"H	90276	\$238.50 ea.
-------------------	--------------	--------------



A

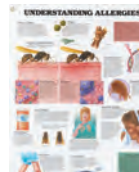

B



C

Asthma, Allergy & Respiratory Charts

Laminated charts with metal eyelets in the top corners.

20"W x 26"H

A. Understanding Asthma	12002	\$32.25 ea.
B. Understanding Allergies	12034	\$32.25 ea.
C. Your Respiratory System	12038	\$32.25 ea.



A



B



C

Harmful Effects Wall Charts

This series of brightly colored posters will quickly become a mainstay of your health room decor! All posters are laminated and have eyelets for ease of hanging.

24"W x 36"H

A. Smoking	12121	\$12.70 ea.
B. Marijuana	12120	\$12.70 ea.
C. Alcohol	12119	\$12.70 ea.

Smoking & Your Health

.....	12000	\$12.70 ea.
Inhalants	12001	\$12.70 ea.
Cocaine	12118	\$12.70 ea.
Steroids	12112	\$12.70 ea.

Concussion Management Solutions for Students

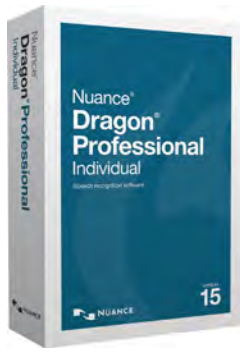

Dragon Professional v15 Speech Recognition Software

Create reports, emails, forms, and more, quickly and accurately by voice. Learns words and phrases used the most to minimize corrections. Automatically adapts to how you want abbreviations, dates, phone numbers, and more to appear. Import and export custom word lists for acronyms or other unique terminology. Create custom voice commands for inserting frequently-used text and graphics. Streamlined setup makes transcription faster and easier than ever, with no voice training required. Includes USB Headset. Compatibility: Windows 7–10.

Standard.....	1006989	\$359.00 ea.
Academic.....	1006988	\$289.00 ea.



C-Pen Reader Pen

Make reading content more accessible, giving independence to students who have difficulty reading. Pocket-sized device scans and reads aloud text. Reading text while hearing it aloud can increase reading speed, fluency and enhance comprehension. Illuminates scanned area for accuracy.

Integrated dictionary provides quick access to definition and pronunciation. Recording feature allows recording voice memos, notes or reminders. Save up to 3GB of scanned material or scan directly to computer for easy electronic note-taking or later review. Compatible with PC, Mac and Linux.

Portable and discrete, 5.3" x 1.3" x 0.75", 1.8 oz. Includes Pen, earbuds, USB cable and case.

C-Pen Reader Pen	1006601	\$285.00 ea.
C-Pen Reader Pen Classroom Set	1006602	\$2,845.00 set



ClaroRead Pro Text-to-Speech Software

Easy-to-use, flexible program helps you read, write and study, aiding concentration and increasing confidence. Reads aloud any on-screen text and scanned paper books.

Reading support: Read text in documents, email, web pages and other programs. Choose highlighting by word or sentence, in any color. Change color of screen, font and text for more comfortable reading.

Writing support: Hear each word or sentence as it is typed, or listen back after text is completed, to hear mistakes. Speaking spellcheck allows selecting from alternatives. Support for homophones and easily confused words. Word prediction suggests words as they are typed and includes phonetic prediction. Speaking dictionary and thesaurus.

Additional features:

- ClaroIdeas: Easy-to-use mind mapping and idea-capturing tool
- Screen Ruler: Reading ruler and screen color tint to help focus with reading
- ClaroCapture Study Tool: Capture images and text from web pages and documents to help write essays and organize references

Compatibility: Windows 7–10. Software is provided as a digital download.

ClaroRead Pro.....	1002962	\$355.00 ea.
--------------------	----------------	--------------



CSMi's SportsWare Injury Tracking Software

Take control of your paperwork with SportsWare—the best-selling injury tracking software year after year. From preseason sign-ups to year-end injury summaries, SportsWare makes it easy to record, manage and report athlete information.

- SportsWare Basic includes athlete, injury, treatment, medication, sign-out and phone book databases
- SportsWare plus includes all of SportsWare Basic Plus insurance (claim tracking), Dr. orders, referrals, surgery, physicals, history, inventory, and equipment databases
- SportsWare quick treatments lets your athletes record their own treatments for you to approve
- SportsWare is network compatible; Basic, plus, and quick treatments can be installed on the same network; floating license means you only have to pay for simultaneous users

Basic	90991	\$313.50 ea.
Plus	90992	\$734.00 ea.
Quick Treatments	90994	\$125.00 ea.
Sac-Trac Concussion	90996	\$734.00 ea.
Billing	90997	\$998.00 ea.



CPR in Schools Training Kit™



American Heart Association.



EXCLUSIVE PRODUCT

SCHOOL HEALTH IS THE SOLE DISTRIBUTOR OF THE CPR IN SCHOOL'S TRAINING KIT

- Includes all tools needed to train 10 to 20 students at a time
- Easy to implement—any educator can lead the training in one class period or less
- Teaches Hands—Only CPR, CPR with breaths, AED skills, and choking relief
- Reusable—one kit can train hundreds
- Includes a Facilitator Guide to help train faculty, staff, parents, volunteers, and community members
- Includes a Facilitator Binder that contains the lesson plan, pre- and post-tests, and additional supplementary material

CPR in Schools Training Kit	54903	\$649.00 kit
CPR in Schools Kit Replacement Products		
Mini Anne Plus Manikin for CPR in Schools Training Kit, Tan	1008071	\$89.15 ea.
Laerdal Resusci Manikin Wipes, 1,200/pkg.	55059	\$343.00 pkg.
Mini Anne Manikin Wipes, 50/pkg.	55058	\$12.85 pkg.
CPR in Schools Replacement Airway Assembly, 50/pkg.	55289	\$95.55 pkg.
Mini Anne Plus Kneel Mat, 10/pkg.	55293	\$59.75 pkg.
Mini Anne AED Trainer Simulator Kit, 5/pkg.	58950	\$33.45 pkg.
Mini Anne Plus Mesh Bag, 2/pkg.	55290	\$23.35 pkg.
Mini Anne Pump Bag	55294	\$23.35 ea.
Mini Anne Plus Airway Lungs, 6/pkg.	55646	\$9.96 pkg.

Training Manikins



Little Anne Q CPR

Little Anne Q CPR works with an Instructor app allows instructors to monitor and coach up to six students at once, and the Learner app lets students monitor their own performance. Little Anne Q CPR helps instructors improve CPR training quality and efficiency in their courses, while adding a fun and engaging element for students that promotes learning and motivation.

Little Anne Q CPR is still the same durable, lightweight manikin as the original Little Anne, but now includes Q CPR technology that provides:

- Real-time feedback on compressions and ventilations
- A summary with an overall score and improvement suggestion
- Provides suggestion for improvement, post-session
- Details on compression release, depth and rate, ventilation volume, number of compressions/ventilations/cycles
- CPR feedback results are saved in the app
- Free download on App Store

Laerdal Little Anne Adult CPR Manikin with Q CPR Feedback

Light Skin	59907	\$267.00 ea.
Dark Skin	59908	\$269.00 ea.
4/Pack, Light Skin	59909	\$986.00 pkg.
4/Pack, Dark Skin	59916	\$986.00 pkg.

Laerdal Little Anne Q CPR Upgrade Kit

Convert your regular Little Anne® manikin to the Little Anne Q CPR manikin with this upgrade kit.

.....	59917	\$76.40 ea.
-------	--------------	-------------

Laerdal Little Anne with Q CPR SkillGuide with Extension Cable

The new SkillGuide provides the ability to measure, track and therefore improve a student's CPR skills. Small, lightweight and portable, SkillGuide provides a tethered "plug and play" option for instructors. It can also be used standalone or as a supplement to either the instructor or student apps.

.....	59911	\$74.15 ea.
-------	--------------	-------------

Little Junior Q CPR Manikin

The next generation of the Little Junior manikin includes Q CPR measurement and feedback technology that takes the guesswork out of pediatric CPR instruction. Little Junior Q CPR works with an instructor app that allows you to monitor and coach up to six students at once and a Learner app lets students monitor their own performance. All existing Little Junior manikins can be quickly and easily upgraded to Q CPR with the Little Junior Q CPR Upgrade Kit.

The Q CPR technology includes:

- Real-time feedback on compression depth and rate, recoil and ventilation volume
- Post-event debriefs including percentage score, overall performance summary, and tip for improvement

Existing Little Junior manikins can be upgraded in minutes with the Junior Q CPR Upgrade Kit.

Light Skin	54796	\$267.50 ea.
Light Skin, 4-Pack	54798	\$985.50 pkg.
Dark Skin	54797	\$267.50 ea.
Dark Skin, 4-Pack	54799	\$985.50 pkg.
Junior Q CPR Upgrade Kit (upgrade for existing manikins)	54813	\$72.00 kit

Laerdal® Little Anne and Little Junior Accessories

Resusci® Manikin Wipes

Individual foil packets containing 70% ethyl alcohol to disinfect between mouth-to-mouth practice.

50/pkg	55058	\$12.85 pkg.
--------------	--------------	--------------

Laerdal® Resusci® Manikin Face Shields

36/box	55046	\$13.85 box
--------------	--------------	-------------

Little Anne Manikin Faces

Light Skin Faces		
6/pkg.....	55051	\$71.85 pkg.

Brown Skin Faces

6/pkg.....	55089	\$71.85 pkg.
------------	--------------	--------------

Disposable Airways

24/box	55087	\$65.05 box
--------------	--------------	-------------

96/pkg.....	55086	\$252.50 pkg.
-------------	--------------	---------------

Little Anne Valve Complete

50/pkg.....	1002798	\$94.05 pkg.
-------------	----------------	--------------

Filter and Lung

100/pkg.....	1002799	\$90.40 pkg.
--------------	----------------	--------------

Little Junior Accessories

Little Junior Manikin Faces

6/pkg.....	55121	\$71.55 pkg.
------------	--------------	--------------

Little Junior Manikin Airways

25/pkg	55123	\$77.10 pkg.
--------------	--------------	--------------

100/box	55124	\$237.50 box
---------------	--------------	--------------

COMPRESSION INDICATOR LIGHTS FULLY ILLUMINATE WHEN CORRECT DEPTH HAS BEEN ACHIEVED!



The Brayden Manikin Includes:

- (1) Spare face
- (1) Lung bag
- (10) Face shields
- (6) "C" cell batteries
- (1) Instructions for use
- (1) School Health carry bag can also be used as a training mat

24⁵/₈" L x 14³/₈" W x 9¹/₈" D. Weight: 9.5 lbs.

.....	55758	\$499.00 ea.
Aero CPR Manikin Faceshields, 36/box.....	55995	\$11.00 box
Replacement Skin		
Face.....	55759	\$18.55 ea.
Body.....	55764	\$89.99 ea.
Replacement Lung Bag.....	51170	\$68.15 ea.

A. Prestan® CPR Manikins

Prestan manikins are uniquely designed as a clamshell to accommodate an easy-to-insert face shield/lung bag. Medium skin tone.

Features:

- Realistic manikin is more acceptable to both instructors and students
- Full chest rise and lung bag ensures that students receive the most accurate and realistic training
- Clicker increases student's confidence in adequate compressions
- Clicker sounds as the chest is pushed to the appropriate depth

Prestan Manikins without CPR Monitor					
<ul style="list-style-type: none"> • Includes: 1 Manikin, 10 Face Shield/Lung Bags, 1 Vinyl Carrying Case • 4-Pack Includes: 4 Manikins, 50 Face Shield/Lung Bags, 1 Vinyl Carrying Case (Fits Four) 					
Infant	Infant 4-Pack	Child	Child 4-Pack	Adult	Adult 4-Pack
55401	55405	55303	55305	54486	54490
\$123.50	\$468.50	\$109.00	\$407.00	\$132.00	\$506.50

Jaw-Thrust Manikin Head allows the manikin to simulate the way an actual victim's head would need to be manipulated if the victim had a suspected spinal injury and required CPR.

Prestan Jaw Thrust Manikins without CPR Monitor	
<ul style="list-style-type: none"> • Includes: 1 Manikin, 10 Face Shield/Lung Bags, 1 Carrying Case • 4-Pack Includes: 4 Manikins, 50 Face Shield/Lung Bags, 1 Vinyl Carrying Case (Fits Four) 	
Adult	Adult 4-Pack
54495	54499
\$158.00	\$612.50

Brayden CPR Manikin

The Brayden CPR manikin is a new, innovative CPR manikin that offers the most realistic CPR feedback of any manikin on the market today!

CPR Feedback Features:

- Chest Compression Indicating Lights—Illuminate to represent the volume of blood being circulated; volume depends on the depth of compressions—these will fully light when the depth of compressions is the correct depth
- Blood Circulation Indicating Lights—These illuminate to represent the floor of blood from the heart to the brain; the speed of the blood flow shown varies according to the depth and speed of the compressions—these will only fully light once the rate of compressions is over 100 per minute
- CPR Quality Indicating Light—This illuminates to represent that blood is reaching the brain—this will only fully light when the depth and speed of the compressions are correct

Additional Features:

- Audible feedback reinforces correct compression depth (clicker on/off)
- Oral and nasal passages allow realistic nose pinch
- Realistic chest movement with correct ventilations
- Head tilt and chin lift for opening airway
- Anatomically correct
- Easy AED training pad removal
- Air vent reduces the risk of cross contamination; air from disposable lungs exits through the back of the head
- Six set of alkaline batteries can power 160,000 compressions AC supply optional



• 3 YEAR WARRANTY
• ONLY \$85 PER MANIKIN



B. Prestan® Ultralite® Manikin

- Unique fast set-up and cleaning
- Stackable torsos and heads ensures a compact package for transporting
- Compatible with AED trainer pads
- Anatomically correct design includes xyphoid process
- Realistic chest compressions to a 2" depth
- Realistic head tilt
- Visible chest rise with lung bag
- Unique torso web design for realistic feel

Includes:

- (4) Manikin torsos
- (4) Manikin heads
- (4) Compression pistons
- (1) Nylon piston bag
- (50) Face-shield lung bags
- (1) Nylon carrying case
- (1) Detachable shoulder strap
- (1) Instruction sheet

Prestan Ultralite Manikin, 4/pkg.....	55410	\$399.50 pkg.
Prestan Ultralite Face Shields, 50/pkg.....	55412	\$20.35 pkg.
Prestan Ultralite Lung Bags, 50/pkg.....	55413	\$27.65 pkg.

Not made with Natural Rubber Latex.

SERVICE CENTER



CALIBRATION | PARTS | REPAIR

CALL US FOR ALL YOUR EQUIPMENT SERVICE AND MAINTENANCE NEEDS

Providing proper maintenance to your screening and diagnostic tools is important to ensure the accuracy and longevity of your equipment. Our certified service center technicians have the knowledge, tools and expertise to ensure your equipment is working properly. We offer:

- **Calibration**—Ensure your screening equipment operates within the specifications and meets all relevant standards.
- **Onsite**—Calibration available in select areas. Contact our Customer Care Representatives to learn more, 866-323-5465.
- **Parts**—Replace worn components and broken parts to keep your health equipment working optimally.
- **Expert Technicians**—Each technician has over 10 years of hands-on experience. We work closely with each product manufacturer to learn the latest technologies.
- **Repairs**—Get preventative maintenance and repairs to extend product life and sustain performance.
- **Value**—Our competitive prices and customer-focused service make the service experience effortless for you.

We offer parts and services for a wide range of equipment, such as Sphygmomanometers and Otoscopes!

866-323-5465 | SchoolHealth.com/ServiceCenter

Medical Authorization Form

(Please print when hand writing your information)

Company / School Name: _____

Attention: _____

Address: _____

City: _____ State: _____ Zip: _____

E-mail: _____

Phone: () _____ - _____ Fax: () _____ - _____

Please also include a signed Purchase Order with this form, for the product(s) being ordered.

This Certificate of Authority is executed on behalf of the above named Company/School as well as other locations listed in attached list which are authorized to purchase the Medical Device(s) and/or prescription drug(s) (checked below) from School Health Corporation.

Medical Devices being ordered*: Please check boxes

Ultrasound Unit **Muscle Stimulator/T.E.N.S.**

The Company/School named above is solely responsible for meeting all federal, state, and local training requirements and laws concerning said medical device(s).

Physician/Licensed Practitioner Name: _____ State License**/Cert. No.: _____

Signature: _____ Date: _____

AEDs* being ordered: Please check box

AED

The Company/School named above is solely responsible for meeting all federal, state, and local training requirements concerning emergency response procedures and use of automated external defibrillator(s).

Physician/Authorized Prescriber Name: _____ State License Number**.: _____

Signature: _____ Date: _____

Prescription Pharmaceuticals* being ordered: Please check boxes

EpiPen® Regular/Junior **Auvi-Q** **Epinephrine Autoinjector (Generic)** **Prescription Drugs:** _____

This is to certify that all such drugs will be prescribed, dispensed or administered under the supervision of a practitioner licensed by law to prescribe, dispense and/or administer such drugs.

Physician/Licensed Practitioner Name: _____

DEA Registration Number: _____ State License Number** _____

Signature: _____ Date: _____

The Food & Drug Administration considers defibrillators to be prescription devices pursuant to 21 CFR 801.109 and medical authorization is required. Most states provide immunity from civil liability to the physician prescribing an AED. State legislation can be accessed through your state's website, medical board or on <http://www.aedhelp.com>.

* If medical devices, AEDs, and prescription pharmaceuticals are to be used in other locations besides the address listed, please attach a separate list and submit with this form. **Please include a copy of the State License for the above named practitioner. This document must be completed and returned. We will not accept generic Rx documentation as a substitute.

Coming in 2020



Get ready for a better shopping experience!

Our new website will have a fresh modern look, improved navigation, and more useful tools to make it easier for you to shop for the products you need.

SCHOOLHEALTH.COM

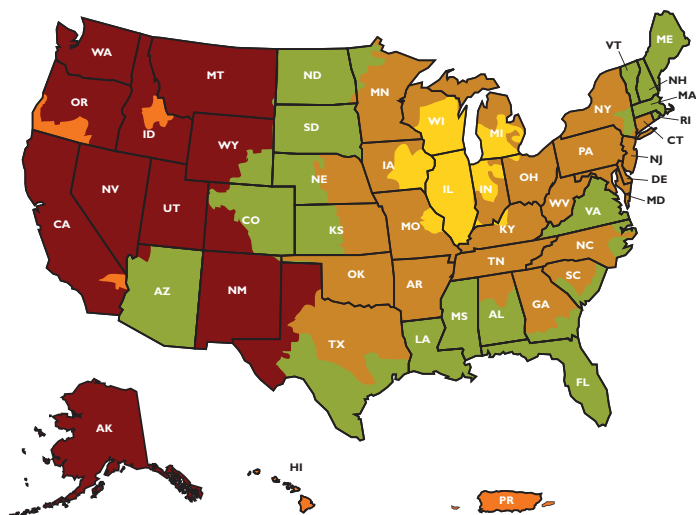

1-Day Transit Day 2-Day Transit Days 3-Day Transit Days 4-Day Transit Days 5-Day Transit Days

This information is intended for general guidance only. Scheduled delivery days are revised from time to time as changes in weather, technology, distribution and volume occur. Service to some remote residential areas may require additional delivery days.

Satisfaction Guarantee Policy

It is our promise that School Health Corporation will do everything possible to ensure that our customers are completely satisfied with our products and services. If you are not satisfied for any reason, simply call our Customer Care Center at 866-323-5465, or send an email to: customerservice@schoolhealth.com.

- If you are not satisfied, Rob Rogers, President of School Health Corporation, asks that you send him an email to: president@schoolhealth.com, or fax him at 800-235-1305
- If goods are damaged upon arrival, please mark the shipper's document "received damaged," sign it, keep a copy for your records and call our Customer Care Center and the shipping company immediately, as time limits for claims may apply
- UPS shipments with visual damage should be refused
- Freight carrier shipments with visual damage should be noted on the carrier's freight bill "received damaged" and that portion of the delivery should be refused
- Some colors and finishes may differ slightly from our catalog representation; color swatches are available at no charge upon request
- Returns or exchanges may result in a restocking fee; please contact our Customer Care Center if you have any questions

Warranty Policy

All items sold in this catalog are backed by their manufacturer's warranties and a one-year limited School Health warranty that is applied to all of our products. For further information, contact our Customer Care Center at 866-323-5465 or email us at: customerservice@schoolhealth.com.

SOURCE CODE **TC**

Use any of these four convenient ways to order

Online SchoolHealth.com/SportsMed

Get FREE SHIPPING on your online order over \$100!
Go to the back cover for Free Ship Online code. Can only be used once per customer. Expires 12-31-20.

Phone

866-323-5465

Fax

800-235-1305

Mail

5600 Apollo Drive
Rolling Meadows, IL 60008

1. Ship To:

SH Account # _____ PO# _____

Name _____ Title _____

School/Organization Name _____

Street Address _____

City, State _____ Zip _____

Phone # _____ Fax # _____

Email Address _____

2. Bill To:

Same as above

Name _____ Title _____

School/Organization Name _____

Street Address _____

City, State _____ Zip _____

Phone # _____ Fax # _____

Email Address _____

Order Authorized By:

Print Name _____

Title or Department _____

Check this box if you would like to receive our newsletters and special offers.

Email Address: _____

3. Your Order:

SH Item #	Quantity	Description	Color	Price	Total
TC					
TC					
TC					

Complete Your Order on the Other Side.

See Terms and Conditions on Reverse Side.

4. Method of Payment

Check Bill My Account Money Order

Credit Card  School Health Gift Card

Credit Card Number/Gift Card Number

Signature of Cardholder _____

Expiration Date _____

Name as it appears on card _____

Shipping & Handling Information for the Continental U.S.

Non-Prefix Items

Order Value	Applied Charges
Under \$125	\$12.95
\$125-\$299	\$19.95
\$300+	7.0% of sales

X Items X##### (Heavy-O/S) 16% of sales, minimum

T Items T##### (Truck) 16% of sales, plus \$50

C Items C##### (Heavy Freight) Please call to order

Shipping Policy for Products on page 128-196

	Applied Charges
Non-Prefix Items ##### and X Items X##### (Heavy-O/S)	
Sales Under \$125	Shipping Charge: \$12.95
Sales \$125+	Shipping Charge: 16% of sales
T Items T##### (Truck)	16% of sales, plus \$50
C Items C##### (Heavy Freight)	Please call to order

Order Form



Be sure to mention the SOURCE CODE for this catalog to make sure you receive any special offers and promotions!

Use any of these four convenient ways to order

Online SchoolHealth.com/SportsMed Get FREE SHIPPING on your online order over \$100! Go to the back cover for Free Ship Online code. Can only be used once per customer. Expires 12-31-20.	Phone 866-323-5465	Fax 800-235-1305
Mail 5600 Apollo Drive Rolling Meadows, IL 60008		

Item #	Quantity	Description	Color	Price	Total
TC					
TC					
TC					
TC					
TC					
TC					
TC					
TC					

Thank you for your order!

Merchandise Total	
S&H (see previous page)	
Sales Tax (Attach tax-exempt certificate if applicable)	
TOTAL	

▲ CHOKING HAZARD (1) – SMALL PARTS
Not for children under 3 yrs.

▲ CHOKING HAZARD (2) – IS A SMALL BALL
Not for children under 3 yrs.

▲ CHOKING HAZARD (3) – CONTAINS A SMALL BALL
Not for children under 3 yrs.

▲ CHOKING HAZARD (4) – IS A MARBLE
Not for children under 3 yrs.

▲ CHOKING HAZARD (5) – CONTAINS A MARBLE
Not for children under 3 yrs.

▲ CHOKING HAZARD (6) – BALLOON
Children under 8 yrs. can choke or suffocate on uninflated or broken balloons. Adult supervision required. Keep uninflated balloons from children. Discard broken balloons at once.

Sales Tax: Customers will be charged applicable taxes, unless proof of tax-exempt status is furnished to School Health. Tax-exempt customers should attach/include a copy of their tax exemption certificate with their order. All Schools Get Instant Credit with Valid Purchase Order: Call our customer care team for details.

International orders welcome: Please call, fax or email for shipping and payment information.

Prices: We reserve the right to change prices due to unforeseen increases or decreases in manufacturer's prices. Catalog prices are current as of January 1, and are subject to change without notification.

Return of Merchandise Guarantee: Call our Customer Care Center to obtain your Return of Merchandise Authorization (RMA) Number. Returns received without an RMA# will not be accepted and no credit shall be issued.

Software: Software downloads are considered opened at the time of purchase and may only be replaced with identical software/media within 30 days if the original purchased software is defective.

Direct-SHIP: Merchandise shipped directly from the manufacturer to the customer.

Restocking Fee: A restocking fee of 10-20% may be charged for returned goods. The fee(s) will be assessed by the company receiving the merchandise (School Health or a vendor).

Damaged on Arrival: Inspect all shipments before accepting. If a package is visibly damaged, refuse to accept until delivery receipt is marked "Received in Damaged Condition." Immediately contact the Customer Care Center at School Health.

Claims: Claims for damage should be immediately filed with the transportation company. If concealed damage is discovered upon unpacking, contact the Customer Care Center immediately.

Price Matching: School Health is committed to delivering the best products at the best value. All products are competitively priced and our price matching policy guarantees we will match a price in a competitor's catalog, from the same published year, for identical items/quantities.

Shortages: Shortage, lost, or missing merchandise is our responsibility only after the following precautionary measures have been followed by the customer.
 (1.) Do not sign delivery ticket unless all packages specified on Bill of Lading are accounted for. If receipt has been signed for total delivery, carriers assume no responsibility.
 (2.) Check your master Packing Slip. Direct-SHIP Items or those on back-order will be delivered separately.
 (3.) Check all packages marked miscellaneous merchandise carefully.
 (4.) If summer delivery has been made, check your warehouse carefully.

School Health Corporation makes every effort to depict accurate product descriptions and prices. However, due to changing manufacturing conditions, product color, specifications and prices are subject to change without notice. We reserve the right to correct typographical errors. Due to press variation, actual product color may be slightly different than product colors shown in this catalog.

School Health is committed to delivering the best products at the best value!

With our Price Match Guarantee, you can be assured that you are getting the best price available for the products you order from School Health.



All School Health products are competitively priced and our price matching policy guarantees we will match a price in a competitor's catalog from the same published year, for identical items and quantities.



It is easy to make sure you are getting the best price.



If you spot a price that is lower than the School Health listed price, capture it so you can share it with us.



Send the information you found to us and receive your Price Match Guarantee!

* Clearance prices do not qualify, discounts cannot exceed manufacturer's unilateral minimum price where applicable and all price guarantee adjustments are completed at the time of purchase. Customer must provide proof of pricing (including, but not limited to, copy of price from competitive catalog, website, or bid received by customer).

3M Avagard93	Adhesive Bandages	Agility
3M Surgical Tapes.....18	Bulk70,72	Hurdles..... 176
3M Tegaderm HP Transparent Film Dressing74	Coverlet72	Jump Ropes 165
3M Tegaderm Hydrocolloid Dressing74	Hartmann Conco Flex-Band72	Ladders..... 169
	School Health Brand70	Obstacle Course..... 174
	Adhesive Pads.....76	Parachute 171
	Adhesive Tape.....19	Reaction Balls..... 168
	Adhesive Tape Remover Pads 283	Sled..... 170
	Advil Products.....268,272	Albuterol..... 264
	AEDS221-224	Alcohol
	Cabinets..... 226	Ethyl278,282
	Program Management..... 225	Isopropyl278,282
	Afrin 268	Prep Pads..... 94,282
		Saliva Screening Test..... 276
		Aleve Products..... 268
		Alka Seltzer 265



A & D Ointment279,282
Abdominal Pads76
Acetaminophen 271
Acrylic Jar Sets..... 345
Activated Charcoal 266
Active Ankle30
Acuforce104,131
Adapta Treatment Platform 330
Adhesive Stretch Tape ..12,13,19,20

Product Index

Allergy Products	Asthma Products	Bandages.....23
Relief Medicine.....264,268,269	Chambers.....306	Adhesive.....70,72
Storage.....264	Nebulizers.....306	Cohesive.....15,23
Training.....264	Peak Flow Meters.....306	Conforming.....77,78
Aloe Vera.....281	Atago Refractometer.....218	Elastic.....23,24
Amerigel Products.....283	Athlete's Foot.....277	Finger/Toe Bobs.....78
Ammonia Inhalants.....272	Athletic Tape	Gauze.....76-78
Analgesic Lotions	and Accessories.....8,10,11,13,15	Liquid.....282
and Sprays.....129,285,286	Athletic Trainer Bags.....323	Self Adherent.....23
Analgesics.....271,272	Athletic Trainer Bags and Kits.....	Tubular Compression.....23
Anatomical	255-257,259,260	BAPS Board.....136
Charts.....351	Athletic Trainer's Table.....323	Batteries and Flashlights.....348
Models.....350	Audio	Bausch & Lomb.....274
Anbesol.....275	Bluetooth Speaker.....196	Bayer Aspirin.....272
Aneroid Sphygmomanometers	Wireless Transmitter.....196	Beam Scales.....311
.....296,297	Auto Injector.....264	Bee Venom Cleanser.....279
Ankle Braces.....26-32	Automatic Blood	Benzalkonium Chloride.....88
Antacids.....265,266	Pressure Monitors.....298-300	Benzoin Tincture.....22
Anti-Itch Powder.....277		Betadine.....278,282
Anti-Itch Spray.....277,278,280	Bacitracin Zinc.....279	Biohazard Products
Antibacterial	Back Packs and Slings.....251	Containers.....96
Skin Care..90,91,93,277,279,282	Back Support.....48	Protective Apparel.....343
Surface Cleaners.....84-88	Backboards.....239	Blankets
Antibacterial Surface Cleaners.....84	Bactine.....277	Emergency.....248
Antibiotic Ointment.....279	Bags	Thermal.....341
Antidiarrheal.....265,266	Baggies.....342	Bleach Sprays & Wipes.....85,87,94
Antifungal.....277	Ice Bags.....342	Blister Care.....67,68
Antiperspirant.....273	Ziploc Bags.....101,342	BlisterShield.....68
Antiseptics.....84,277-279,282	Zipper.....101,342	Blood Clotting.....80
Applicators.....79	Balance	Blood Alcohol Tests.....276
Aquaphor Ointment.....281	BOSU.....141	Blood Glucose Monitors.....307
Arch Supports Pads.....59	Dyna-Disc.....139	Blood Lancets.....308
Arm Sleeve.....44	Stability Training.....138-140	Blood Pressure Instruments296-300
Aspirin.....272	Balls	Blood Pressure Monitor.....298
Assessment	Exercise.....146,147	Blood Pressure Monitor.....298
Flex Tester.....195	Medicine Balls.146,147,152-154	Bluelce Flex Gel Pack.....99
HRM's.....194	Stability Balls.....166	Body Mass Indicator (BMI)
InstaPulse Monitors.....194	Weighted.....170	Calculator.....312
Jump Tester.....195		Caliper.....312
Modified Pull-Up.....195		Scales.....309,310
Push-Up Mat.....195		

Bodyweight Training	Carts Utility.....333,335	Conforming Gauze Bandages.76-78
Chin Up Bar162,163	CatTongue Grips..... 347	Connex ProBP
Core Strengthening163,164	Cavicide84	Blood Pressure Unit 298
Lebert Equalizer..... 160	Chairs	Contact Lens Products 274
Paralettes..... 160	Evacuation..... 237	Cool Down Tubs..... 217
Peg Climbers..... 160	Stools..... 338	Coolers/Cooler Stand 199
Push-Up Bars 164	Transport 240	Corn Pads 58
Slider Discs..... 163	Chamber 306	Cotton
Suspension Trainer.....160,161	Chapstick..... 275	Applicators79
TRX 161	Charcoal Activated 266	Balls.....79
Books..... 350	Chloraseptic 270	Rolls.....79
Boxing	Cinder Suds Spray..... 283	Swabs 79
Heavy Bag Mitts..... 183	Circuit Training	Cotton Roll.....79
Heavy Bags 183	Challenge Mats 186	Couches, Recovery 325
Punch Mitts 183	Exer-Dice 188	Cough Relief268-270
Speed Bag 183	HotSpots.....187,192	Coverlets72
Training Gloves 183	Smart Fitness Systems..... 189	Cramp Tabs 217
Braces.....34	Station Cards.....186,187	Creams and Ointments
Braces and	Claritin..... 268	Antiseptic277,278
Protective Equipment..... 26-32	Cleaning Products	Burn 279
Bulbs	Surface Cleaners 84-88	Cleansing 279
Lamps 336	Cleanser, Bee Venom..... 279	First Aid..... 279
Welch Allyn.....304,305	Clear Eyes..... 274	Hemorrhoid 277
Butterfly Closures70	Clif Bar214,216	Insect279,280
	Clorox87	Itch 277,278,280
C-Fold Towels 343	Closures, Wound.....70,73	Lubricant..... 280
Cabinets	Cloth Tape 19	Pain Relief.....277,280
Custom.....314,317	Cohesive Bandage.....23	Poison Ivy 280
Medical.....314,317	Cohesive Tapes..... 15-17	Rash279,282
Modular Cabinetry.....314,317	Cold Relief..... 268-270	Crepe Paper & Sheets 341
Wall314,317	Cold Therapy.....98,99	Crutch Bag..... 259
Cabinets 333	Cold Packs.....103,104	Crutches 241
Caladryl Lotion 280	Ice Bags..... 103	Cubicle Curtains336,337
Calagel..... 278	Cold-Eeze..... 269	Cup Dispensers198,340
Calamine Lotion 280	Compression	Cups.....198,340
Calf and Shin Sleeve Supports33	Band.....39	Curity AMD Gauze 76
Canker Sore Products..... 275	Bandages23	Curtains, Privacy336,337
Capes and Gowns..... 343	Sleeves33,34,44	Cutting Tools 248
Carmex..... 275	Concussion Education Tool Kit.. 350	

Product Index



DayQuil.....	270	Disposables		Emergency Kits.....	234
Dazor Lamps	336	Exam Garments	343	Emergency Supplies	234,248
De-Hesive Tape Remover.....	22	Hot/Cold Pack Sleeves.....	98	Emesis Basins.....	346
Decongestant.....	268-270	Paper Products	341,343	EMT ToothSaver.....	275
Dehydration Relief.....	273	Sheets.....	341	Epinephrine	264
Dental Care		Specula.....	305	Auto-Injector	264
Emergency Kit.....	275	Thermometers	295	EpiPen	264
Orthodontia.....	275	Washcloths	343	EpiPen Trainer	264
Pain Relief.....	275	Disposal Sharps Containers	96	Storage	264
Wax.....	275	Dosage Spoons and Syringes	284	Epsom Salt	279
Deodorant.....	273	Drinking Fountain Portable.....	203	Equipment Cases	261,262
Detecto Scales.....	311	Drug Tests	276	Eucerin Lotion.....	281
Devilbiss Suction Pump	228	Dual Taping Station	321	Evacuation Chairs.....	237
Diabetes Products		Dukal Gauze	77	Everest & Jennings Wheelchair	240
Education	308	Dumbbells.....	147	EvoShield Protective Guards	41,43
Supplies &		DuraShock		Exam	
Screening Tests	307,308	Sphygmomanometer.....	296,297	Bibs.....	343
Training Kit.....	308	Dyna-Disc	139	Capes.....	343
Diagnostic Center.....	304			Gloves.....	81-83
Diagnostics Sets.....	304,305	Econoline Foam Padding	56,57	Gown	343
Diaper Rash Cream	282	Econoline Podiatry		Lamps	336
Diarrhea Medication.....	265,266	Products	52,58,59	Paper Rolls	341
Digital MacroView	304	Elastic Bandages	23,24	Tables.....	320,321
Digital Refractometer	218	Elastikon	13	Exercise.....	148
Digital Scales	309,310	Elbow		Bands and Tubing.....	142-145
Digital Thermometers.....	295	Brace.....	45	Mats.....	190,191
Disaster Preparedness Kits	234	Pads	44	Weights.....	147
Disinfectants	84-88	Sleeves	44	Exercise Machines	
Wipes	88	Electrocardiograph	297	Bike	149
Dispatch.....	87	Electrodes		Elliptical.....	148
Dispensers		ECG.....	297	Rower	149
Adhesive Strips.....	72	Stimulation.....	116,119,120	Treadmill	148
Cotton Roll.....	79,345	Electrolyte Drinks		UBE.....	148
Cups.....	198,340	and Chews	216,217	Exoclear Sports Wrap	102
Gloves.....	83	Electronic Blood		Eye Care Products	274
Hand Sanitizer.....	90,91	Pressure Monitors	298-300	Eye Drops.....	274
Soap	93	Electronic Mat Platforms.....	331	Eye Wash.....	274
		Electronic Thermometers	295	EyeBlack	347
		Electrotherapy	116,117	Eyecups.....	274
		Emergency Dental Kit.....	275		

F

Face Guard.....49

Face Mask Removal..... 248

Facial Tissues..... 344

Fanny Packs 250

Fat-O-Meter 312

Feminine Hygiene..... 344

Feminine Pain Relief..... 272

Finger Protection43

Finger/Toe Bobs.....78

Fingertip Pulse Oximeter..... 301

Fire Blanket..... 248

Firm Grip 346

First-Aid

 Creams 278-280

 Sprays 277

Flexi-Wrap 102

Flexicon.....78

Floor Scales.....309,310

Flooring

 Interlocking Tiles 182

 Rolled..... 182

FMx Fmxtactor..... 248

Foam Padding 52,55-59

Foam Rollers.....134,135

Foaming Hand Sanitizers.....90

Folding Panel Screen..... 336

Folding Stretchers.....238

FOOBAG Med Kit 260

Foot Care

 Digital Caps.....66

 Insoles.....62,63

 Pads.....64,66

 Toe Separators66

Foot Powder..... 277

Foot Stools..... 338

Freezer Bags.....101,342

Freezers Chilling Units
and Accessories..... 108

Functional Training

 Battle Ropes 175

 Plyoboxes 167

 Sandbags 155

G

Garbage Bags..... 342

Garbage Cans..... 338

Gas Relief 265

Gatorade..... 199,201,206-209-211

Gauze

 Bandages 76-78

 Pads.....76

 Rolled..... 76-78

 Sponges.....76,77

 Trauma Dressings.....76

Glare Sticks..... 347

Glove Dispensers83

Glove Pouch 253

Gloves 81-83

Glucose Gel & Tablets 308

Gold Bond.....277

Grips 347

Groin Straps/Thigh Brace.....40

H

Hair Clippers..... 346

Halls Cough Drops 269

Hand Aneroid.....296,297

Hand Cleaners91,93

Hand Creams & Lotions..... 281

Hand Sanitizer90,91,93

Hands & Face Wipes90,91,93,94

Hazardous Waste.....96

Health o meter Scales 310

Heartburn Relief.....265,266

Heat Guard 217

Heat Index Calculator..... 246

Heat Monitoring.....245,246

Heat Relief Tablets 217

Heat Therapy98,99

 Pads..... 104

Heel

 Cups67

 Cushions67

 Heel and Lace Pads21

 Pads64,67

Hemorrhoid Ointment 277

Hi-Lo Tables.....330,331

Hibiclens.....93

Hibistat.....93

Histoacryl Topical Skin Adhesive282

Honey Stinger Products..... 213

Hospital Ware 346

Hot Wax Treatment..... 104

Hydration Monitoring..... 218

Hydration Products199,206,209-211

Hydration Systems202-204

HydraTrend..... 218

Hydrocollator

 Accessories/Units.....105,106

Hydrocortisone Cream.....278,280

Hydrogen Peroxide..... 278

 Cleaner87

Hygea Products..... 94,273

Hygiene Station.....83

Hypoallergenic Tapes..... 18

I

Ibuprofen.....268,272

Ice

 Bags and Accessories..... 100





 Machines/Makers 109-111

 Scoop.....109,111

Ice Bags, Plastic.....101,342

Illuminating Magnifier..... 336

Product Index

Immobilizers	239	Knee.....	37	Medi-Rip.....	15
Imodium.....	265,266	Anatomical Model.....	350	Medical Authorization Form.....	357
Incline Board	136	Braces.....	34-36	Medical Bags.....	255-257,260
Infectious Waste Containers	96,338	Pad.....	37	Medical Cabinets	314,317
Inhalation Solution	264	Sleeve	34,38	Medication Supplies	
Inhalers.....	264	Straps.....	38,39	Dropper.....	284
Injection Pad	308	Supports	34,37,38	Pouch.....	284
Insect Bite Relief	279			Spoon	284
Insect Response Repellent	279	Lamps	336	Syringe.....	284
Insole Material	62	Lancets.....	308	Tray.....	346
Insoles	63	Laser Treatment.....	117	Medicine Organizers.....	284
InstaKool.....	98	Latex Exam Gloves.....	83	Medique Products	265,266,268-272
Instrument Tray	346	Latex-Free Exam Gloves	81,82	Midol	272
Instruments, Cart	335	Lavender Gloves.....	82	Mineral Ice	277
Insufflator.....	304,305	Leg Lift Taping Table.....	324	MiniWright Peak Flow Meter.....	306
Iodine.....	278	Leg Sleeve	37	Minute Timer.....	347
logel Electrodes.....	120	Leukostrips.....	73	Mobile Cabinet.....	333
lomed Products	120	LifeSecure Kits.....	234	MobileAid.....	234
lonto Patch	120	Lighting	336	MobileAid Backpack	234
Irrigation Eyewash Solution.....	274	Lightning Detectors	245	Modular Cabinets	314,317
Isopropyl Alcohol	278,282	Lip Balm.....	275	Moisturizers.....	281
Itch Relief Spray.....	277,278,280	Lotions	281	Moleskin.....	52
iWalk.....	241	Lozenges.....	269,270	Motion Sickness Relief.....	266
		Lubriderm.....	281	Motrin	272
Jar Sets, Sundry	345	Ludens Throat Drops	270	Mouthguards.....	50
Jaybird Products	10,12,13	Lumbar Support.....	48	MRSA Products	84-88,91,93
Jergens Lotion.....	281	Lysol Products.....	86	MultiTrauma Dressing	76
Jumper Knee Strap.....	39			Nausea Relief	265,266
		MacroView Otoscope.....	304	Nebulizers & Accessories	306
K-Y Jelly.....	280	Magic Grip	346	Needles.....	284
Kaopectate	265	Magnifying Lamp	336	Neo-Synephrin.....	268
Kinesiology Tape	20	MailBack Sharps Containers.....	96	Neosporin Ointment.....	279
Kits, Emergency/Disaster	234	Massage.....	133	NexTemp Thermometer	295
Kleenex	344	Lotion.....	286	Nitrile Gloves	82,83
Kleenhantz	91	Star	131	Nivea Lotion	281
		Tools.....	104,128,131-135	Non-Adherent Pads	76
		McDavid Ankle Braces	27	Nonin Pulse Oximeters.....	301
		Measuring Tape	312	Nose Guard.....	49
		Medi-Lyte	217	Nosebleed Products.....	80

Nutrition.....	209,212	Peroxide, Hydrogen.....	278	Psychrometers.....	245
Nutrition Bar.....	212,214,216	Petroleum Jelly.....	280	Pull-N-Pak Ice Bags.....	100
Nutritional		Phisoderm.....	279	Pulse Oximeter.....	301
Supplements & Vitamins.....	209,212	Physician Scales.....	309-311	Pulse Oximeters.....	301
NyQuil.....	270	Pill Products		Purell Hand Sanitizer.....	90
O		Box.....	284	PVP Iodine Products.....	278
Off! Insect Repellent.....	279	Counter.....	284		
Ointments.....	277,279-282	Crusher.....	284	Q	
Omnifix Tape by Conco.....	19	Cutter.....	284	Q-Tip Style Cotton Swabs.....	79
Ophthalmics.....	274	Envelopes.....	284	Quench Gum.....	217
Ophthalmoscopes.....	304,305	Organizer.....	284	Quidel QuickVue Tests.....	276
Orajel.....	275	Pillows & Pillow Cases.....	332,341	R	
Oral Care		Plastic Bags.....	100	Radio Portable.....	247
Cold Sore Relief.....	275	Pocket Aneroid.....	296,297	Radio Pouch.....	253
Pain Relief.....	275	Pocket Chambers.....	306	Rash Cream and Ointment..	279,282
Penlight.....	303	Pocket Oscopes.....	303,305	Razors.....	282
Syringe.....	284	Pocket Tissues.....	344	Reader Pen.....	352
Wax.....	275	Podiatry Products.....	62-67	Rebounder.....	146,147
Orthodontic Wax.....	275	Poison Adsorbent.....	266	Recovery Couch.....	126
Otoscopes.....	304,305	Poison Ivy Wash.....	280	Recovery Couches.....	325
Oxygen.....	227	Portable Products		Reference Materials	
P		Cooler Stand.....	199	Anatomical Charts & Models	351
Padded Apparel.....	54	Drinking Units.....	202-204	Books.....	350
Padding Foam.....	52,55-59	Exam Table.....	332	Refractometer.....	218
Pain Relief.....	271,272	Treatment Table.....	318	Refresh Plus.....	274
Panel Screens.....	336	Povidone Iodine Swab.....	278	Remedy Skin Care.....	281
PanOptic Ophthalmoscope.....	305	Powder.....	277,282	Rescue Blanket.....	248
Paper and Plastic Products		PowerFlo Hydration.....	204	Rescue Pump.....	228
Exam.....	341	Prep Pads.....	84,88,94,278,282	Resistance Training.....	144,145
Roll Dispenser.....	332	Prep Shaver Kit.....	282	Bands.....	142-144,180
Towels.....	343	Preparation H.....	277	Overspeed Trainer.....	173
Paraffin Heat Therapy System ...	104	Preparedness Kits.....	234,248	Overspeed Trainers.....	172,173
PDI Prep Pads.....	88,94,278,282	Prescription (Rx) Drugs.....	264	Tubing.....	144,145
Peak Flow Meters.....	306	Privacy Screens.....	336	Vertical Trainers.....	173
Ped G Products.....	65	Pro Fitter.....	138	Respiratory Aid Products.....	228
Pedialyte.....	217,273	Pro Stretch.....	136	Restroom Supplies.....	343
Pedometers.....	312	ProBP Blood Pressure Unit.....	298	Resuscitators.....	228
Penlights.....	303	Professional Bags/Kits.....	255	Reusable Hot/Cold Packs.....	98,99
Pepcid AC Tablet.....	265	Professional Towels.....	343	Revolving Stools.....	338
Pepto Bismol.....	266	Protein Powder.....	209	Rib Protection.....	43
		Protein Shake.....	209		

Product Index

Rolled Gauze	76-78	Shears.....	248	Sting Relief Swabs	279
Roller Massager	132	Sheets Disposable	341	Stools.....	338
Rubbermaid Products	335	Shipping Cases.....	262	Stopwatches and Timers	347
Rubbermaid Products	217	Shock Doctor Knee	35	Storage Bags.....	101,342
S		Shoulder Anatomical Model	350	Storage Carts & Racks.....	141
SafeSkin Gloves	82	Shoulder Back and		Barbell Rack.....	158,177
Safety Syringes	284	Neck Supports	40,46,47	Dumbbell Rack	156-158
Saline Solution	274,283	Sickness Bags.....	95	Fitness Step Cart.....	184
Saline Wipes.....	94,273	Sideline Cart.....	201	Foam Roller Rack.....	135
Saline Wound Wash.....	283	Sidelines Table.....	318	Kettlebell Rack.....	159
Sandwich Bags.....	101,342	Sinus Pressure Relief.....	268-270	Medicine Ball Rack	152,154
Sani-Cloth Wipes	85	Skeleton Models.....	350	Stability Ball Rack.....	166
Sani-Hands Wipes	91	Skin Adhesive.....	22,282	Weight Tree	177
Sanitary Surface Wipes.....	84	Skin Care	277-283	Yoga Mat Rack	193
Sanitizer, Hand.....	90,91	Skin Lubricants	21	Storage Organizers.....	345
Sanitizing Wipes & Sprays	84-88	Skinfold Calipers.....	312	Strep Tests.....	276
Sanizide.....	88	Sling Bag.....	253	Stretchers	238,239
Save-A-Tooth.....	275	Sling Psychrometer.....	245	Stretching and Resistance Training ...	136,137,142-145
Scales.....	309-311	Smooth Exam Paper Rolls	341	Stryker Evacuation Chair	237
School Health Brand Products		Soaps	93,273	Suction Units.....	228
Adhesive Bandages	70	Software	352	Sudafed.....	269
Cleansing Towelettes	94	Sore Throat Relief	269,270	Sundry Jar Sets	345
Disposable Towels	343	Specialty Wound Care	77	Sunscreen.....	283
Elastic Bandages.....	23	Specimen Containers.....	276	Surface Disinfectants & Cleaners.....	84-88
Gloves.....	81,82	Specula.....	303,305	Surgical and Specialty Tape.....	18,19
Hand Sanitizer.....	91	Speech Recognition Software....	352	Surgical Clipper.....	346
Hot/Cold Packs	99	Sphygmomanometers.....	296,297	Surgical Tape.....	19
Prep Pads.....	94	Spine Boards	239	Surgilast Elastic Bandage.....	78
Sphygmomanometers.....	296	Splinter Removers.....	308	Swabs	278,279
Sponges.....	287	Split Leg Table	324	Syringes	284
Screening Tests, Medical.....	276	Sponges, Cellulose.....	287		
Screens.....	336	Sponges, Gauze	76,77	T	
Search and Rescue	234,248	Stability Products	138-140	Tables	
Seca Products	309,312	Stainless Steel Utensils.....	346	Exam	320
Self-Adherent Wrap	23	Stair Chairs.....	237	Paper.....	341
Sesamoid Pad.....	59	Step Stools	338	Treatment	320,321,325
Sharps Containers.....	96	Step-On Waste Cans	338	Tables - Taping and Treatment	318,322-324
Sharps MailBack Disposal	96	Steri-Strips	73		
Shaver Kit.....	282	Sterile Water	283		
		Stethoscopes.....	302		
		Stik-It.....	22		
		Stimulators and Ultrasound			
		114,116,119-121		

Tacki-Mat.....	348	Towel	217	V	Vaporub	270
Tampax.....	344	Towel Dispenser.....	343		Vaseline.....	280
Tampons	344	Towels	341,343		Vaseline Intensive Care Lotion... 281	
Tape	19	Training & Conditioning	146,147		Vectra Genisys.....	117
Adherents and Removers	22	Training & Conditioning			Vending Machines	344
Adhesive Stretch 12,13,15,19,20		Body Bars.....	154		Vicks Products	270
Athletic Tape.....	8-13,15,19,20	Fitness Step	184		Vinyl Exam Gloves.....	81
Cohesive	15-17	Fluid Resistance Trainer.....	155		Vionex Products.....	93
Measure.....	312	Weighted Vest.....	155		Visine.....	274
Remover.....	22	Trampolines	140		Vital Signs Products	
Remover Pad	283	Transmission Gels	120		296-300,304,305	
Roll Holder	9,259	Transport Chairs.....	240		Vitamin A & D Ointment	279,282
Station	321,322	Trash Cans.....	338		Voice Recognition Software	352
Surgical and Specialty Tape 18,19		Trauma Kit.....	234		Vomit Bags & Cleanup	95
Tables.....	318,321,322	Traveler Wheelchair	240	W		
Taping Block	22	Treatment Cabinet.....	314		Walking Boot	32
Telescopic Curtain	336	Treatment Tables.....	320,321,325		Wall Cabinets.....	314
Telfa Pads	76	Treatment Tables.....	320,321,325		Wall Charts	351
Tensoplast	13	Treatment/Taping Tables and ...	332		Wart Treatments	283
Tests		Stations	318,323		Washcloths	341,343
Glucose	276	Triple Antibiotic Ointment	279		Waste Cans.....	338
Influenza	276	Trunks.....	261,262		Water Bottles.....	200,202
Mono	276	Tubular Compression Bandage	23		Water, Sterile.....	283
Strep.....	276	Tubular Elastic Bandage.....	78		WaterBoy Products.....	202,203
Text To Speech Software	352	Tuf-Skin Adherent.....	22		WaterJel Products.....	280
Thera-Band Products.....		Tums	265		Waterproof Adhesive Tape	18
138,142,144,145		Two-Way Radios	247		Wax.....	104
ThermoFlo Hydration Stations ..	204	Tylenol.....	271		Wax, Orthodontic.....	275
Thermometers	295	U			Weather Indicators	
Thigh and Hip Supports.....	40	UBE.....	148		Heat Index.....	246
Throat Relief.....	268-270	Ultrasound Products	116,117		Sling Psychrometers.....	245
Thumb Brace.....	43	Ultraviolet Lamps.....	336		Wet Globe Kit.....	245
Tick Removal.....	279	Underpads.....	341		Weather Monitoring	245,246
Timers.....	185,347	Underwraps.....	14		Wedge Pillow	332
Tissues	344	Urine Screening.....	276			
Toilet Seat Covers.....	343	Utility Carts.....	335			
Toothache	275					
Top Sponge.....	77					
Topical Adhesive.....	282					
Topical Analgesics	129,285,286					
Touchless Dispenser	90					

Product Index

Weight Lifting	Wipes88
Accessories 177,178,180	Alcohol Hand Sanitizers.....
Barbells158,178	90,91,93,94
Benches 181	Hygiene..... 273
Dumbbells..... 156-158	Saline 94
Kettlebells..... 159	Sanitizing84-88,90,91,93
Olympic Plates..... 179	Witch Hazel.....279,282
Sandbells..... 158	Wobble Boards.....138,139
Weight Racks 334	Wound Care and First Aid..... 283
Wet Ones..... 273	Wound Cleanser277,283
Wheelchairs..... 240	Wound Closure Strips 70,73
Whirlpools	Wound Closure, Adhesive..... 282
Extremity Tanks 112	Wound Dressing Gauze.....76,77
Tables 113	Wound Wash 283
Tank Top Seat..... 113	Wound Wash Saline..... 283
Wilson Case Travel Trunks ..261,262	Wrist Support41,42
Winner Evo..... 114	



Yoga
Block..... 192
DVD..... 192
Mat Rack..... 193
Mats.....192,193



Zantac 265
Zinc Oxide.....279,282
Ziploc Bags101,342
Zipper Reclosable Bags101,342
Zyrtec 269

Can't find what you are looking for?

School Health Corporation has several catalogs to choose from. If you would like to receive any of our additional catalogs listed below visit: **SchoolHealth.com/catalog-request**. On this webpage you can sign up to receive a catalog in the mail or view our Virtual Catalogs online.



Thank you for choosing School Health!



SH Health Services for School Nurses



SH Sports Medicine for Athletic Trainers & Coaches



SH Health Services for Medical Professionals



SH Special Education
Assistive Technology



SH Early Childhood & Head Start

School Health Brand Products

Quality and value without the name brand prices



Find them all online at SchoolHealth.com/SHB

School Health Corporation
5600 Apollo Drive
Rolling Meadows, IL 60008

PRSRTPM
U.S. POSTAGE
PAID
School Health Corporation

ATTENTION: If addressed person is unavailable, please forward this catalog to their successor or to one of the following departments: Athletic Trainer or Athletic Director, Coach.

Source Code

TC

Mention source code when ordering. Prices are subject to change.

Free Ship Code

SP20

Use this code for free shipping on your online order over \$100. One use per customer. Expires 12-31-20.

Online **SchoolHealth.com/SportsMed**
Phone **866-323-5465**
Fax **800-235-1305**
Email **orders@schoolhealth.com**
Mail **Order form on pages 359-360**



SH office use only, 812020



Is your bag ready?

BAGS & CASES
PAGE 250-262

THERAWORX
PAGE 94

SCISSORS & CUTTERS
PAGE 288

SKIN SQUARES
PAGE 68

UNDERWRAP
PAGE 14

ELASTIC WRAP
PAGE 24

BANDAGES & WOUND CARE
PAGE 70-74

TAPE
PAGE 8-20

GLOVES
PAGE 81-83

Tab 1



January 6, 2020

Catalog Discount Exclusions

School Health Corporation may offer special discounts to organizations meeting specific criteria. These discounts recognize existing or anticipated annual purchase volume and are intended for customers seeking a mutually beneficial relationship.

Historically, we have provided all our customers with common list prices. Thus, your discount will be based upon the same list price offered in our catalogs, websites, and other marketing publications.

Certain products are excluded from our blanket discounts due to various reasons including but not limited to manufacturer restrictions, special pricing already in place (sales or promotions), unknown shipping costs (due to weight or size variances), etc.

The following items in the 2020 School Nurse, Sports Health, EnableMart and all other Catalogs are excluded from a catalog discount:

- Medical Recordkeeping Software and other software products
- Injury tracking software
- Prescription (Rx) products
- Customized Kits
- Products denoted by Exclusive icon
- Gatorade products & Gatorade Performance Series products
- EnableMart Software
- Braille Paper
- Current "Special Promotion" items already offered at a discounted priced. School Health runs sales throughout the year. Our catalogs contain numerous promotions denoted by the Special Offer icon. Also, look for seasonal savings offered in our spring and Back-to-School flyers.

The following **capital equipment products** are excluded from your standard catalog discount. These items may require special setup, in-service education, and may have varying freight costs due to weight. Please call us for special discounts on these products. In some cases, the discount on these items may be greater than your standard discount:

- Furniture items and Appliances listed
- Vision and Hearing screening equipment
- Automated External Defibrillators (AED's)
- Braille Embossers

To receive a detailed list of catalog discount exclusions by product number (SKU), or if you have any questions regarding this bid, please call us at (866)323-5465 or email bids@schoolhealth.com. If you require additional information or questions about placing orders from this bid, contact the Customer Care Department: (866)323-5465, fax (800)235-1305, or email orders@schoolhealth.com.

5600 Apollo Dr
Rolling Meadows, IL 6008
Toll Free 866-323-5465 Fax 800-235-1305

Tab 2



Products/Pricing

a. Products/Pricing

- i. School Health is offering an 11% catalog discount with some exclusions on Athletic, Physical Education and Team Uniforms. See the included catalog discount exclusion list provided in our response. Discounts are off our current catalog or website pricing. Our websites are: www.schoolhealth.com and www.palossports.com.
- ii. See attached on the flash drive a copy of our catalogs.
- iii. Yes, pricing is available for all products and services
- iv. School Health does not offer installation on our products.
- v. Please contact our Contract Sales team at bids@schoolhealth.com to obtain pricing for non-standard products to receive a quote.
- vi. School Health is offering free shipping on orders over \$125. Shipping will be \$12.95 on orders under \$125. Oversize fee's apply to applicable items based on weight and size of the item.
- vii. Manufacturers warranties apply and are backed by a one year limited School Health warranty.
- viii. Call our Customer Care Center to obtain your Return of Merchandise Authorization (RMA) number. Returns received without an RMA # will not be accepted and no credit shall be issued. Restocking fees vary from 10-20%.
- ix. Quantity breaks may apply. Contact our Contract Sales team at bids@schoolhealth.com to see if your quote qualifies for additional discounts.
- x. Customers need to reference Region 4 ESC Contract # 20-11 or School Health quote # 3793158 when inquiring on pricing or looking to place an order.
- xi. Payment terms are Net 30 and acceptable payment methods include: check or credit card (American Express, Visa, Master Card and Discovery). No additional fees are applied when paying by credit card or P-card.
- xii. Catalog discount will remain the same for the life of the contract. Pricing will be updated on an annual basis.
- xiii. School Health continues to offer the newest and most innovative products in the market.
- xiv. N/A

Tab 3



Performance Capability

i. Supplier Response

3.1 Company

- a. We are a national, full-service provider of health supplies and services to health professionals in educational settings from pre-school to college. We collaborate with customers and are an advocate for the health and wellness of those entrusted in their care. At School Health, we maintain the integrity in each of our interactions by always keeping our mission and value statements in mind.

Since our founding in 1957, School Health has been dedicated to helping school-based health professionals keep their students healthy. We all know that healthier students are better students. From our initial focus on school nurses, we have expanded to serve athletic trainers, early childhood specialists and special needs educators.

Our comprehensive offering includes health supplies, sports medicine equipment, early childhood products, physical education, recreation and athletic products and special needs aids. School Health goes beyond merely supplying products, providing product support, training, advisory services and exceptional customer care.

- b. School Health Corporation has 17 outside sales representatives and 7 inside sales representatives.
- c. School Health Corporation has 2 locations located at 5600 Apollo Drive, Rolling Meadows, IL 60008 and 11711 S Austin Ave, Alsip, IL 60803.
- d. Annual Sales for the previous 3 years are:
- i. 2019 – \$65,000,000
 - ii. 2018 – \$63,000,000
 - iii. 2017 – \$60,000,000
- e. Tax ID Number – 36-2425385 / Duns Number – 02-490-6331
- f. Our green initiatives include - Reduce materials entering the waste stream. Promote and achieve increased and preferential use of materials with recycled content. We use environmentally preferable recyclable plastic air pillows when shipping packages which reduce the need for excessive packing materials. Emphasize and increase the purchase and use of environmentally preferable products. School Health promotes “virtual catalogs” as an option to customers.

For green products, please go to the following link:

<http://www.schoolhealth.com/product-group/secondary-category/more-ways-to-shop?cat=383>

5600 Apollo Drive, Rolling Meadows, Illinois 60008
Phone 866-323-5465 | Fax 800-235-1305



School Health plans to attain LEED certification in our new 112,500 sq. ft. building. School Health uses T-8 Lighting in our warehouse. The benefits of T-8 lighting are the following –

- Dimmable- Fluorescents have always been difficult to dim and some aren't dimmable at all. Today's LEDs dim easily.
- Directional- This simply means lighting can be directed exactly where you need it, rather than getting diffused and spread over a large area or even lost within the fixture itself.
- Work Well with Controls- LEDs work seamlessly with occupancy sensors and other control systems. Not so for fluorescents.
- More Energy Efficient- T8 LEDs are typically more energy efficient than LFLs.
- Better Light Quality- Fluorescents flicker. LEDs don't. And LEDs produce light in a wide variety of colors.

Freight Consolidation

- Order consolidation is the process of shipping multiple orders going to the same address.
- Allows for one larger shipment instead of shipping individual cartons to a customer.
- Consolidation reduces the impact of shipping inefficiencies by decreasing the overall number of shipments per address.
- By combining multiple orders the customer receives less shipments, which reduces freight \$ expenses.
- This process saves on energy consumption and fuel usage allowing this to be a green initiative.

School Health's largest logistics provider is UPS and is one of our key strategic partners in the organization. UPS is committed to some of the largest Sustainability improvements in the Supply Chain industry. In 2016, **UPS shipped over 201,000 SH packages** across the United States. The lifecycle of a UPS Package Car is below which outlines the main improved efficiencies;

SH SCHOOL HEALTH®

We Supply Your Future™



The Lifecycle of a UPS Package Car

We collaborate with our suppliers to make our iconic brown delivery vehicles as efficient as possible throughout their long operational life.

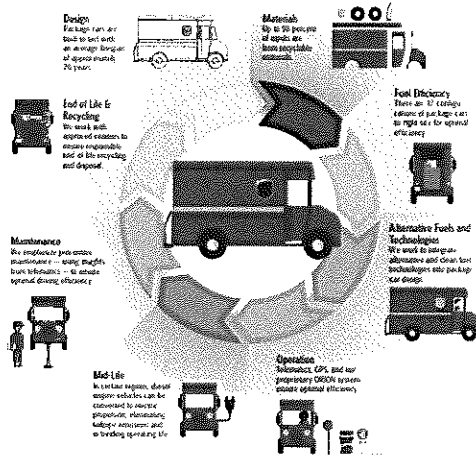

As part of our Green initiative SH purchases all of our corrugated boxes from Landsberg – Orora. Attached is a letter stating the green components of the recycled products.

- g. School Health Corporation does not hold any certifications or Minority Women Business Enterprise, SBE, Disadvantaged Business Enterprise, HUB or HUBZone.
- h. School Health does not plan to use subcontracts as a part of our response to this bid.
- i. First, by awarding the single source contract to School Health, your members will have the ability to purchase over 25,000 quality products, equipment and supplies on a National level pricing scale. Next, the contract permits smaller departments to obtain our exclusive packages and software typically offered to only large or National customers. Our contract customers benefit by having a dedicated and fully trained sales and customer care team assigned to each territory, as well as one dedicated to National Accounts. We assist with product questions, training and services without additional cost to the end user. Our staff regularly researches state mandates to anticipate questions, source products or equipment to meet state requirements prior to the specified date of a law taking effect. The Region 4 ESC contract allows our School Health team to be a huge asset to our customers by taking excellent service to the next level, saving their administration time and money, and relieving them of the expensive bid process. School Health Corporation has products and services in all requested areas. School Health has the widest spectrum of products and services in the market for customers in the



- athletic and PE market. School Health publishes a sports medicine and PE supplies catalog in the spring. Each catalog mailing consists of 35,000 catalogs.
- j. School Health Corporation does not have any past litigation, bankruptcy, reorganization, state investigations of entity or current officers and directors.
 - k. School Health Corporation is not owned or operated by anyone who has been convicted of a felony
 - l. School Health Corporation does not have any debarment or suspension actions against the company.

3.2 Distribution, Logistics

- a. School Health is a full spectrum distributor of products relating to Health Services (School Nurse), Sports Medicine, Special Education, Head Start, and Early Childhood markets with an emphasis on Health & Safety, Medical, Surgical and First Aid Related Equipment, Supplies, Accessories and Services. We offer over 25,000 products from 850 vendors.
- b. School Health Corporation is a national provider of supplies. We sell to all 50 states, Canada and international customers. We will ship mostly using UPS and larger shipments going through our freight carriers.
- c. Customers need to reference Region 4 ESC Contract # 20-11 or School Health# 3793158 when inquiring on pricing or looking to place an order.
- d. School Health will ship items from our Rolling Meadows, IL or Alsip, IL warehouse, however some products may come directly from the manufacturer. Smaller shipments will be sent via UPS while larger shipments may come using one of our many freight carriers.
- e. School Health Corporations warehouse is 131,000 sq ft located in Rolling Meadows, IL and Alsip, IL.

3.3 Marketing and Sales

- a. Here is our 90 day marketing plan:
 - Co-branded press release within 30 days of the award
 - Announcement of award through social media sites (FB, Twitter)
 - Advertisement of contract on the website
 - Direct mail campaigns (that can include Region 4 ESC contract details)
 - Email campaigns
 - Co-branded marketing collateral
 - Participation in trade shows together

Dedicated Region 4 ESC web page from School Health site with:

- Region 4 ESC logo
- Link to Region 4 ESC website
- Summary of contract and services offered
- Documents, including: copy of solicitation, copy of contract and any amendments, and marketing materials



- b. Here is our 90 day marketing plan:
- Co-branded press release within 30 days of the award
 - Announcement of award through social media sites (FB, Twitter)
 - Advertisement of contract on the website
 - Direct mail campaigns (that can include Region 4 ESC contract details)
 - Email campaigns
 - Co-branded marketing collateral
 - Participation in trade shows together
- Dedicated Region 4 ESC web page from School Health site with:
- Region 4 ESC logo
 - Link to Region 4 ESC website
 - Summary of contract and services offered
 - Documents, including: copy of solicitation, copy of contract and any amendments, and marketing materials
- c. School Health Corporation will look to promote this contract and provide training to our sales team. See our references for a list of current national contracts.
- d. School Health Corporation will supply logo upon contract agreement with OMNIA Partners.
- e. School Health Corporation will be proactive in direct sales of goods and services through this contract.
- f. School Health Corporation will train our sales team on the OMNIA Partners contract and create marketing materials to distribute to our sales team.
- g. Contact Information
- i. Executive Support – John Rooney / Vice President of Sales / jrooney@schoolhealth.com / 630-339-7921
 - ii. Marketing – Nicole Farrell / Sr Manager, Customer Marketing / nfarrell@schoolhealth.com / 630-339-7887
 - iii. Sales – Gina Streepy / National Accounts Manager / gstreepy@schoolhealth.com / 630-339-7986
 - iv. Sales Support – Gail Kinatader / National Accounts Support / gkinatader@schoolhealth.com / 866-323-5465
 - v. Financial Reporting – Andrew Wlezen / Contract Sales Supervisor / bids@schoolhealth.com / 866-323-5465
 - vi. Accounts Payable – Julissa Meloun / Accounts Payable / ap@schoolhealth.com / 800-323-1305
 - vii. Contracts – Andrew Wlezen / Contract Sales Supervisor / bids@schoolhealth.com / 866-323-5465
- h. Our sales team is divided into an East/West region. Our East region is managed by Doug Zybrands (dzybrands@schoolhealth.com) and West region managed by Cyrus Severance (cseverance@schoolhealth.com).



- i. Our sales team will be trained on the Region 4 ESC contract and work in conjunction with OMNIA Partners.
- j. See our references provided for information on purchases in the last fiscal year.
- k. Customers will be able to order via fax, email, mail, phone or on the dedicated landing page for Region 4 ESC.
- l. School Health Corporation will guarantee sales in each of the following years:
 - i. \$5000 in year one
 - ii. \$7000 in year two
 - iii. \$10,000 in year three
- m. School Health will provide contract or better pricing depending on the situation. Our sales representatives will be heavily involved with evaluating the situation and determining the best price.
- ii. We've reviewed these documents and will respond accordingly.
- iii. See included documents
- iv. Emergency orders are prioritized when being entering into our system and prioritized when orders are sent to our warehouse for picking/packing/shipping.
- v. School Health's average Fill Rate is 97%
- vi. Our call center enters 98% of orders we receive the same day.
- vii. Call our Customer Care Center to obtain your Return of Merchandise Authorization (RMA) number. Returns received without an RMA # will not be accepted and no credit shall be issued. Restocking fees vary from 10-20%.
- viii. Manufacturers warranties apply and are backed by a limited School Health one year warranty.
- ix. - School Health Corporation has an inbound calling center that will address customers' needs Monday through Friday 7am-5pm CST. We answer 95% of inbound calls within 20 seconds.
- x. Invoices are generated once your order ships. Payment terms are Net 30 and acceptable payment methods include: check or credit card (American Express, Visa, Master Card and Discovery). No additional fees are applied when paying by credit card or P-card.
- xi. Here is our implementation plan:

Week 1:

- School Health will provide detailed information to the sales, sales support, and customer care teams to ensure they are aware of the contract and eligible entities within the first week.
- School Health will provide contact information of eligible entities to the sales team in order that they may make direct contact
- School Health will begin development of a dedicated Region 4 ESC landing page.
- Meetings with management and National Account Managers to create roll out and training

Weeks 2-3:

- School Health will distribute direct mail and email communication to eligible entities to provide awareness of the benefits of this contract.



- School Health will continue working on the dedicated Region 4 ESC landing page, input pricing and begin testing.
 - Train Sales Team
- Weeks 4-8:**
- School Health will have a regular schedule of email and/or direct mail communication to eligible entities to maintain awareness and highlight products and promotions.
 - Custom landing page will go live training follow up with the territory managers
- xii. School Health Corporation is in great financial condition and can provide bank references upon request.
- xiii. Capabilities/Functionalities of Ordering Website:
- Ability to enter a list of item numbers and quantities to quickly add to cart.
 - Search by keyword or item number to locate product and learn more about it.
 - Build a comparison list to quickly compare products side-by-side
 - Build a supply list and save your most frequently purchased items for easy ordering
 - Email your supply list to others, where they can save it to their supply list or add to their cart
 - Live chat if you want to "talk" to a person without picking up the phone
 - View product stock statuses as you shop
 - Checkout with a PO number, a credit card, or both
 - Online return form to request a return
 - Punch-out capability available upon request for accounts that meet minimum sales requirements
 - Contract pricing available online available upon request for accounts that meet minimum sales requirements
- xiv. School Health's safety is a top priority for the company. We have a secure building where access will need to be granted to non-employees to enter the building. Our warehouse takes many measures to ensure the safety of the warehouse team providing proper training for lifting heavy boxes, forklift driving and general best practices.
- xv. N/A

Appendix D



REQUIREMENTS FOR NATIONAL COOPERATIVE CONTRACT TO BE ADMINISTERED BY OMNIA PARTNERS

The following documents are used in evaluating and administering national cooperative contracts and are included for Supplier's review and response.

Exhibit A – RESPONSE FOR NATIONAL COOPERATIVE CONTRACT

Exhibit B – ADMINISTRATION AGREEMENT, EXAMPLE

Exhibit C – MASTER INTERGOVERNMENTAL COOPERATIVE PURCHASING AGREEMENT, EXAMPLE

Exhibit D – PRINCIPAL PROCUREMENT AGENCY CERTIFICATE, EXAMPLE

Exhibit E – CONTRACT SALES REPORTING TEMPLATE

Exhibit F – FEDERAL FUNDS CERTIFICATIONS

Exhibit G – NEW JERSEY BUSINESS COMPLIANCE

Exhibit H – ADVERTISING COMPLIANCE REQUIREMENT

EXHIBIT A

RESPONSE FOR NATIONAL COOPERATIVE CONTRACT

1.0 Scope of National Cooperative Contract

Capitalized terms not otherwise defined herein shall have the meanings given to them in the Master Agreement or in the Administration Agreement between Supplier and OMNIA Partners.

1.1 Requirement

Region 4 ESC (hereinafter defined and referred to as “Principal Procurement Agency”), on behalf of itself and the National Intergovernmental Purchasing Alliance Company, a Delaware corporation d/b/a OMNIA Partners, Public Sector (“OMNIA Partners”), is requesting proposals for Athletic, Physical Education Supplies, and Team Uniforms. The intent of this Request for Proposal is any contract between Principal Procurement Agency and Supplier resulting from this Request for Proposal (“Master Agreement”) be made available to other public agencies nationally, including state and local governmental entities, public and private primary, secondary and higher education entities, non-profit entities, and agencies for the public benefit (“Public Agencies”), through OMNIA Partners’ cooperative purchasing program. The Principal Procurement Agency has executed a Principal Procurement Agency Certificate with OMNIA Partners, an example of which is included as Exhibit D, and has agreed to pursue the Master Agreement. Use of the Master Agreement by any Public Agency is preceded by their registration with OMNIA Partners as a Participating Public Agency in OMNIA Partners’ cooperative purchasing program. Registration with OMNIA Partners as a Participating Public Agency is accomplished by Public Agencies entering into a Master Intergovernmental Cooperative Purchasing Agreement, an example of which is attached as Exhibit C, and by using the Master Agreement, any such Participating Public Agency agrees that it is registered with OMNIA Partners, whether pursuant to the terms of the Master Intergovernmental Purchasing Cooperative Agreement or as otherwise agreed to. The terms and pricing established in the resulting Master Agreement between the Supplier and the Principal Procurement Agency will be the same as that available to Participating Public Agencies through OMNIA Partners.

All transactions, purchase orders, invoices, payments etc., will occur directly between the Supplier and each Participating Public Agency individually, and neither OMNIA Partners, any Principal Procurement Agency nor any Participating Public Agency, including their respective agents, directors, employees or representatives, shall be liable to Supplier for any acts, liabilities, damages, etc., incurred by any other Participating Public Agency. Supplier is responsible for knowing the tax laws in each state.

This Exhibit A defines the expectations for qualifying Suppliers based on OMNIA Partners’ requirements to market the resulting Master Agreement nationally to Public Agencies. Each section in this Exhibit A refers to the capabilities, requirements,

obligations, and prohibitions of competing Suppliers on a national level in order to serve Participating Public Agencies through OMNIA Partners.

These requirements are incorporated into and are considered an integral part of this RFP. OMNIA Partners reserves the right to determine whether or not to make the Master Agreement awarded by the Principal Procurement Agency available to Participating Public Agencies, in its sole and absolute discretion, and any party submitting a response to this RFP acknowledges that any award by the Principal Procurement Agency does not obligate OMNIA Partners to make the Master Agreement available to Participating Procurement Agencies.

1.2 Marketing, Sales and Administrative Support

During the term of the Master Agreement OMNIA Partners intends to provide marketing, sales, partnership development and administrative support for Supplier pursuant to this section that directly promotes the Supplier's products and services to Participating Public Agencies through multiple channels, each designed to promote specific products and services to Public Agencies on a national basis.

OMNIA Partners will assign the Supplier a Director of Partner Development who will serve as the main point of contact for the Supplier and will be responsible for managing the overall relationship between the Supplier and OMNIA Partners. The Director of Partner Development will work with the Supplier to develop a comprehensive strategy to promote the Master Agreement and will connect the Supplier with appropriate stakeholders within OMNIA Partners including, Sales, Marketing, Contracting, Training, and Operations & Support.

The OMNIA Partners marketing team will work in conjunction with Supplier to promote the Master Agreement to both existing Participating Public Agencies and prospective Public Agencies through channels that may include:

- A. Marketing collateral (print, electronic, email, presentations)
- B. Website
- C. Trade shows/conferences/meetings
- D. Advertising
- E. Social Media

The OMNIA Partners sales teams will work in conjunction with Supplier to promote the Master Agreement to both existing Participating Public Agencies and prospective Public Agencies through initiatives that may include:

- A. Individual sales calls
- B. Joint sales calls
- C. Communications/customer service
- D. Training sessions for Public Agency teams
- E. Training sessions for Supplier teams

The OMNIA Partners contracting teams will work in conjunction with Supplier to promote the Master Agreement to both existing Participating Public Agencies and prospective Public Agencies through:

- A. Serving as the subject matter expert for questions regarding joint powers authority and state statutes and regulations for cooperative purchasing
- B. Training sessions for Public Agency teams
- C. Training sessions for Supplier teams
- D. Regular business reviews to monitor program success
- E. General contract administration

Suppliers are required to pay an administrative fee of 3% of the greater of the Contract Sales under the Master Agreement and Guaranteed Contract Sales under this Request for Proposal. Supplier will be required to execute the OMNIA Partners Administration Agreement (Exhibit B).

1.3 Estimated Volume

The dollar volume purchased under the Master Agreement is estimated to be approximately \$20M annually. While no minimum volume is guaranteed to Supplier, the estimated annual volume is projected based on the current annual volumes among the Principal Procurement Agency, other Participating Public Agencies that are anticipated to utilize the resulting Master Agreement to be made available to them through OMNIA Partners, and volume growth into other Public Agencies through a coordinated marketing approach between Supplier and OMNIA Partners.

1.4 Award Basis

The basis of any contract award resulting from this RFP made by Principal Procurement Agency will, at OMNIA Partners' option, be the basis of award on a national level through OMNIA Partners. If multiple Suppliers are awarded by Principal Procurement Agency under the Master Agreement, those same Suppliers will be required to extend the Master Agreement to Participating Public Agencies through OMNIA Partners. Utilization of the Master Agreement by Participating Public Agencies will be at the discretion of the individual Participating Public Agency. Certain terms of the Master Agreement specifically applicable to the Principal Procurement Agency (e.g. governing law) are subject to modification for each Participating Public Agency as Supplier, such Participating Public Agency and OMNIA Partners shall agree without being in conflict with the Master Agreement. Participating Agencies may request to enter into a separate supplemental agreement to further define the level of service requirements over and above the minimum defined in the Master Agreement (i.e. invoice requirements, order requirements, specialized delivery, diversity requirements such as minority and woman owned businesses, historically underutilized business, governing law, etc.). It shall be the responsibility of the Supplier to comply, when applicable, with the prevailing wage legislation in effect in the jurisdiction of the Participating Agency. It shall further be the responsibility of the Supplier to monitor the prevailing wage rates as established by

the appropriate department of labor for any increase in rates during the term of the Master Agreement and adjust wage rates accordingly. Any supplemental agreement developed as a result of the Master Agreement is exclusively between the Participating Agency and the Supplier (Contract Sales are reported to OMNIA Partners).

All purchase orders issued and accepted by the Supplier may survive expiration or termination of the Master Agreement. Participating Agencies' purchase orders may exceed the term of the Master Agreement if the purchase order is issued prior to the expiration of the Master Agreement. Supplier is responsible for reporting all sales and paying the applicable administrative fee for sales that use the Master Agreement as the basis for the purchase order, even though Master Agreement may have expired.

1.5 Objectives of Cooperative Program

This RFP is intended to achieve the following objectives regarding availability through OMNIA Partners' cooperative program:

- A. Provide a comprehensive competitively solicited and awarded national agreement offering the Products covered by this solicitation to Participating Public Agencies;
- B. Establish the Master Agreement as the Supplier's primary go to market strategy to Public Agencies nationwide;
- C. Achieve cost savings for Supplier and Public Agencies through a single solicitation process that will reduce the Supplier's need to respond to multiple solicitations and Public Agencies need to conduct their own solicitation process;
- D. Combine the aggregate purchasing volumes of Participating Public Agencies to achieve cost effective pricing.

2.0 REPRESENTATIONS AND COVENANTS

As a condition to Supplier entering into the Master Agreement, which would be available to all Public Agencies, Supplier must make certain representations, warranties and covenants to both the Principal Procurement Agency and OMNIA Partners designed to ensure the success of the Master Agreement for all Participating Public Agencies as well as the Supplier.

2.1 Corporate Commitment

Supplier commits that (1) the Master Agreement has received all necessary corporate authorizations and support of the Supplier's executive management, (2) the Master Agreement is Supplier's primary "go to market" strategy for Public Agencies, (3) the Master Agreement will be promoted to all Public Agencies, including any existing customers, and Supplier will transition existing customers, upon their request, to the Master Agreement, and (4) that the Supplier has read and agrees to the terms and conditions of the Administration Agreement with OMNIA Partners and will execute such agreement concurrent with and as a condition of its execution of the Master Agreement with the Principal Procurement Agency. Supplier will identify an executive corporate sponsor and a separate national account manager within the RFP response that will be responsible for the overall management of the Master Agreement.

2.2 Pricing Commitment

Supplier commits the not-to-exceed pricing provided under the Master Agreement pricing is its lowest available (net to buyer) to Public Agencies nationwide and further commits that if a Participating Public Agency is eligible for lower pricing through a national, state, regional or local or cooperative contract, the Supplier will match such lower pricing to that Participating Public Agency under the Master Agreement.

2.3 Sales Commitment

Supplier commits to aggressively market the Master Agreement as its go to market strategy in this defined sector and that its sales force will be trained, engaged and committed to offering the Master Agreement to Public Agencies through OMNIA Partners nationwide. Supplier commits that all Master Agreement sales will be accurately and timely reported to OMNIA Partners in accordance with the OMNIA Partners Administration Agreement. Supplier also commits its sales force will be compensated, including sales incentives, for sales to Public Agencies under the Master Agreement in a consistent or better manner compared to sales to Public Agencies if the Supplier were not awarded the Master Agreement.

3.0 SUPPLIER RESPONSE

Supplier must supply the following information in order for the Principal Procurement Agency to determine Supplier's qualifications to extend the resulting Master Agreement to Participating Public Agencies through OMNIA Partners.

3.1 Company

- A. Brief history and description of Supplier to include experience providing similar products and services.
- B. Total number and location of sales persons employed by Supplier.
- C. Number and location of support centers (if applicable) and location of corporate office.
- D. Annual sales for the three previous fiscal years.
 - a. Submit FEIN and Dunn & Bradstreet report.
- E. Describe any green or environmental initiatives or policies.
- F. Describe any diversity programs or partners supplier does business with and how Participating Agencies may use diverse partners through the Master Agreement. Indicate how, if at all, pricing changes when using the diversity program. If there are any diversity programs, provide a list of diversity alliances and a copy of their certifications.
- G. Indicate if supplier holds any of the below certifications in any classified areas and include proof of such certification in the response:

- a. Minority Women Business Enterprise
 Yes No
 If yes, list certifying agency: _____
- b. Small Business Enterprise (SBE) or Disadvantaged Business Enterprise (DBE)
 Yes No
 If yes, list certifying agency: _____
- c. Historically Underutilized Business (HUB)
 Yes No
 If yes, list certifying agency: _____
- d. Historically Underutilized Business Zone Enterprise (HUBZone)
 Yes No
 If yes, list certifying agency: _____
- e. Other recognized diversity certificate holder
 Yes No
 If yes, list certifying agency: _____

H. List any relationships with subcontractors or affiliates intended to be used when providing services and identify if subcontractors meet minority-owned standards. If any, list which certifications subcontractors hold and certifying agency.

I. Describe how supplier differentiates itself from its competitors.

J. Describe any present or past litigation, bankruptcy or reorganization involving supplier.

K. Felony Conviction Notice: Indicate if the supplier

- a. is a publicly held corporation and this reporting requirement is not applicable;
- b. is not owned or operated by anyone who has been convicted of a felony; or
- c. is owned or operated by and individual(s) who has been convicted of a felony and provide the names and convictions.

L. Describe any debarment or suspension actions taken against supplier

3.2 Distribution, Logistics

A. Each offeror awarded an item under this solicitation may offer their complete product and service offering/a balance of line. Describe the full line of products and services offered by supplier.

B. Describe how supplier proposes to distribute the products/service nationwide. Include any states where products and services will not be offered under the Master Agreement, including U.S. Territories and Outlying Areas.

- C. Describe how Participating Agencies are ensure they will receive the Master Agreement pricing; include all distribution channels such as direct ordering, retail or in-store locations, through distributors, etc. Describe how Participating Agencies verify and audit pricing to ensure its compliance with the Master Agreement.
- D. Identify all other companies that will be involved in processing, handling or shipping the products/service to the end user.
- E. Provide the number, size and location of Supplier's distribution facilities, warehouses and retail network as applicable.

3.3 Marketing and Sales

- A. Provide a detailed ninety-day plan beginning from award date of the Master Agreement describing the strategy to immediately implement the Master Agreement as supplier's primary go to market strategy for Public Agencies to supplier's teams nationwide, to include, but not limited to:
 - i. Executive leadership endorsement and sponsorship of the award as the public sector go-to-market strategy within first 10 days
 - ii. Training and education of Supplier's national sales force with participation from the Supplier's executive leadership, along with the OMNIA Partners team within first 90 days
- B. Provide a detailed ninety-day plan beginning from award date of the Master Agreement describing the strategy to market the Master Agreement to current Participating Public Agencies, existing Public Agency customers of Supplier, as well as to prospective Public Agencies nationwide immediately upon award, to include, but not limited to:
 - i. Creation and distribution of a co-branded press release to trade publications
 - ii. Announcement, Master Agreement details and contact information published on the Supplier's website within first 90 days
 - iii. Design, publication and distribution of co-branded marketing materials within first 90 days
 - iv. Commitment to attendance and participation with OMNIA Partners at national (i.e. NIGP Annual Forum, NPI Conference, etc.), regional (i.e. Regional NIGP Chapter Meetings, Regional Cooperative Summits, etc.) and supplier-specific trade shows, conferences and meetings throughout the term of the Master Agreement
 - v. Commitment to attend, exhibit and participate at the NIGP Annual Forum in an area reserved by OMNIA Partners for partner suppliers. Booth space will be purchased and staffed by Supplier. In addition, Supplier commits to provide reasonable assistance to the overall promotion and marketing efforts for the NIGP Annual Forum, as directed by OMNIA Partners.

- vi. Design and publication of national and regional advertising in trade publications throughout the term of the Master Agreement
- vii. Ongoing marketing and promotion of the Master Agreement throughout its term (case studies, collateral pieces, presentations, promotions, etc.)
- viii. Dedicated OMNIA Partners internet web-based homepage on Supplier's website with:

- OMNIA Partners standard logo;
- Copy of original Request for Proposal;
- Copy of Master Agreement and amendments between Principal Procurement Agency and Supplier;
- Summary of Products and pricing;
- Marketing Materials
- Electronic link to OMNIA Partners' website including the online registration page;
- A dedicated toll-free number and email address for OMNIA Partners

C. Describe how Supplier will transition any existing Public Agency customers' accounts to the Master Agreement available nationally through OMNIA Partners. Include a list of current cooperative contracts (regional and national) Supplier holds and describe how the Master Agreement will be positioned among the other cooperative agreements.

D. Acknowledge Supplier agrees to provide its logo(s) to OMNIA Partners and agrees to provide permission for reproduction of such logo in marketing communications and promotions. Acknowledge that use of OMNIA Partners logo will require permission for reproduction, as well.

E. Confirm Supplier will be proactive in direct sales of Supplier's goods and services to Public Agencies nationwide and the timely follow up to leads established by OMNIA Partners. All sales materials are to use the OMNIA Partners logo. At a minimum, the Supplier's sales initiatives should communicate:

- i. Master Agreement was competitively solicited and publicly awarded by a Principal Procurement Agency
- ii. Best government pricing
- iii. No cost to participate
- iv. Non-exclusive

F. Confirm Supplier will train its national sales force on the Master Agreement. At a minimum, sales training should include:

- i. Key features of Master Agreement
 - ii. Working knowledge of the solicitation process
 - iii. Awareness of the range of Public Agencies that can utilize the Master Agreement through OMNIA Partners
 - iv. Knowledge of benefits of the use of cooperative contracts
- G. Provide the name, title, email and phone number for the person(s), who will be responsible for:
 - i. Executive Support
 - ii. Marketing
 - iii. Sales
 - iv. Sales Support
 - v. Financial Reporting
 - vi. Accounts Payable
 - vii. Contracts
- H. Describe in detail how Supplier's national sales force is structured, including contact information for the highest-level executive in charge of the sales team.
- I. Explain in detail how the sales teams will work with the OMNIA Partners team to implement, grow and service the national program.
- I. Explain in detail how Supplier will manage the overall national program throughout the term of the Master Agreement, including ongoing coordination of marketing and sales efforts, timely new Participating Public Agency account set-up, timely contract administration, etc.
- J. State the amount of Supplier's Public Agency sales for the previous fiscal year. Provide a list of Supplier's top 10 Public Agency customers, the total purchases for each for the previous fiscal year along with a key contact for each.
- K. Describe Supplier's information systems capabilities and limitations regarding order management through receipt of payment, including description of multiple platforms that may be used for any of these functions.
- L. Provide the Contract Sales (as defined in Section 10 of the OMNIA Partners Administration Agreement) that Supplier will guarantee each year under the Master Agreement for the initial three years of the Master Agreement ("Guaranteed Contract Sales").

\$ _____ .00 in year one
\$ _____ .00 in year two
\$ _____ .00 in year three

To the extent Supplier guarantees minimum Contract Sales, the administration fee shall be calculated based on the greater of the actual Contract Sales and the Guaranteed Contract Sales.

M. Even though it is anticipated many Public Agencies will be able to utilize the Master Agreement without further formal solicitation, there may be circumstances where Public Agencies will issue their own solicitations. The following options are available when responding to a solicitation for Products covered under the Master Agreement.

- i. Respond with Master Agreement pricing (Contract Sales reported to OMNIA Partners).
- ii. If competitive conditions require pricing lower than the standard Master Agreement not-to-exceed pricing, Supplier may respond with lower pricing through the Master Agreement. If Supplier is awarded the contract, the sales are reported as Contract Sales to OMNIA Partners under the Master Agreement.
- iii. Respond with pricing higher than Master Agreement only in the unlikely event that the Public Agency refuses to utilize Master Agreement (Contract Sales are not reported to OMNIA Partners).
- iv. If alternative or multiple proposals are permitted, respond with pricing higher than Master Agreement, and include Master Agreement as the alternate or additional proposal.

Detail Supplier's strategies under these options when responding to a solicitation.

EXHIBIT F
FEDERAL FUNDS CERTIFICATIONS

FEDERAL CERTIFICATIONS
ADDENDUM FOR AGREEMENT FUNDED BY U.S. FEDERAL GRANT

TO WHOM IT MAY CONCERN:

Participating Agencies may elect to use federal funds to purchase under the Master Agreement. This form should be completed and returned.

DEFINITIONS

Contract means a legal instrument by which a non-Federal entity purchases property or services needed to carry out the project or program under a Federal award. The term as used in this part does not include a legal instrument, even if the non-Federal entity considers it a contract, when the substance of the transaction meets the definition of a Federal award or subaward

Contractor means an entity that receives a contract as defined in Contract.

Cooperative agreement means a legal instrument of financial assistance between a Federal awarding agency or pass-through entity and a non-Federal entity that, consistent with 31 U.S.C. 6302-6305:

(a) Is used to enter into a relationship the principal purpose of which is to transfer anything of value from the Federal awarding agency or pass-through entity to the non-Federal entity to carry out a public purpose authorized by a law of the United States (see 31 U.S.C. 6101(3)); and not to acquire property or services for the Federal government or pass-through entity's direct benefit or use;

(b) Is distinguished from a grant in that it provides for substantial involvement between the Federal awarding agency or pass-through entity and the non-Federal entity in carrying out the activity contemplated by the Federal award.

(c) The term does not include:

(1) A cooperative research and development agreement as defined in 15 U.S.C. 3710a; or

(2) An agreement that provides only:

(i) Direct United States Government cash assistance to an individual;

(ii) A subsidy;

(iii) A loan;

(iv) A loan guarantee; or

(v) Insurance.

Federal awarding agency means the Federal agency that provides a Federal award directly to a non-Federal entity

Federal award has the meaning, depending on the context, in either paragraph (a) or (b) of this section:

(a)(1) The Federal financial assistance that a non-Federal entity receives directly from a Federal awarding agency or indirectly from a pass-through entity, as described in § 200.101 Applicability; or

(2) The cost-reimbursement contract under the Federal Acquisition Regulations that a non-Federal entity receives directly from a Federal awarding agency or indirectly from a pass-through entity, as described in § 200.101 Applicability.

(b) The instrument setting forth the terms and conditions. The instrument is the grant agreement, cooperative agreement, other agreement for assistance covered in paragraph (b) of § 200.40 Federal financial assistance, or the cost-reimbursement contract awarded under the Federal Acquisition Regulations.

(c) Federal award does not include other contracts that a Federal agency uses to buy goods or services from a contractor or a contract to operate Federal government owned, contractor operated facilities (GOCOs).

(d) See also definitions of Federal financial assistance, grant agreement, and cooperative agreement.

Non-Federal entity means a state, local government, Indian tribe, institution of higher education (IHE), or nonprofit organization that carries out a Federal award as a recipient or subrecipient.

Nonprofit organization means any corporation, trust, association, cooperative, or other organization, not including IHEs, that:

(a) Is operated primarily for scientific, educational, service, charitable, or similar purposes in the public interest;

(b) Is not organized primarily for profit; and

(c) Uses net proceeds to maintain, improve, or expand the operations of the organization.

Obligations means, when used in connection with a non-Federal entity's utilization of funds under a Federal award, orders placed for property and services, contracts and subawards made, and similar transactions during a given period that require payment by the non-Federal entity during the same or a future period.

Pass-through entity means a non-Federal entity that provides a subaward to a subrecipient to carry out part of a Federal program.

Recipient means a non-Federal entity that receives a Federal award directly from a Federal awarding agency to carry out an activity under a Federal program. The term recipient does not include subrecipients.

Simplified acquisition threshold means the dollar amount below which a non-Federal entity may purchase property or services using small purchase methods. Non-Federal entities adopt small purchase procedures in order to expedite the purchase of items costing less than the simplified acquisition threshold. The simplified acquisition threshold is set by the Federal Acquisition Regulation at 48 CFR Subpart 2.1 (Definitions) and in accordance with 41 U.S.C. 1908. As of the publication of this part, the simplified acquisition threshold is \$250,000, but this threshold is periodically adjusted for inflation. (Also see definition of § 200.67 Micro-purchase.)

Subaward means an award provided by a pass-through entity to a subrecipient for the subrecipient to carry out part of a Federal award received by the pass-through entity. It does not include payments to a contractor or payments to an individual that is a beneficiary of a Federal program. A subaward may be provided through any form of legal agreement, including an agreement that the pass-through entity considers a contract.

Subrecipient means a non-Federal entity that receives a subaward from a pass-through entity to carry out part of a Federal program; but does not include an individual that is a beneficiary of such program. A subrecipient may also be a recipient of other Federal awards directly from a Federal awarding agency.

Termination means the ending of a Federal award, in whole or in part at any time prior to the planned end of period of performance.

The following certifications and provisions may be required and apply when Participating Agency expends federal funds for any purchase resulting from this procurement process. Pursuant to 2 C.F.R. § 200.326, all contracts, including small purchases, awarded by the Participating Agency and the Participating Agency's subcontractors shall contain the procurement provisions of Appendix II to Part 200, as applicable.

APPENDIX II TO 2 CFR PART 200

(A) Contracts for more than the simplified acquisition threshold currently set at \$250,000, which is the inflation adjusted amount determined by the Civilian Agency Acquisition Council and the Defense Acquisition Regulations Council (Councils) as authorized by 41 U.S.C. 1908, must address administrative, contractual, or legal remedies in instances where contractors violate or breach contract terms, and provide for such sanctions and penalties as appropriate.

Pursuant to Federal Rule (A) above, when a Participating Agency expends federal funds, the Participating Agency reserves all rights and privileges under the applicable laws and regulations with respect to this procurement in the event of breach of contract by either party.

Does offeror agree? YES AW Initials of Authorized Representative of offeror

(B) Termination for cause and for convenience by the grantee or subgrantee including the manner by which it will be effected and the basis for settlement. (All contracts in excess of \$10,000)

Pursuant to Federal Rule (B) above, when a Participating Agency expends federal funds, the Participating Agency reserves the right to immediately terminate any agreement in excess of \$10,000 resulting from this procurement process in the event of a breach or default of the agreement by Offeror as detailed in the terms of the contract.

Does offeror agree? YES AW Initials of Authorized Representative of offeror

(C) Equal Employment Opportunity. Except as otherwise provided under 41 CFR Part 60, all contracts that meet the definition of "federally assisted construction contract" in 41 CFR Part 60-1.3 must include the equal opportunity clause provided under 41 CFR 60-1.4(b), in accordance with Executive Order 11246, "Equal Employment Opportunity" (30 CFR 12319, 12935, 3 CFR Part, 1964-1965 Comp., p. 339), as amended by Executive Order 11375, "Amending Executive Order 11246 Relating to Equal Employment Opportunity," and implementing regulations at 41 CFR part 60, "Office of Federal Contract Compliance Programs, Equal Employment Opportunity, Department of Labor."

Pursuant to Federal Rule (C) above, when a Participating Agency expends federal funds on any federally assisted construction contract, the equal opportunity clause is incorporated by reference herein.

Does offeror agree to abide by the above? YES AW Initials of Authorized Representative of offeror

(D) Davis-Bacon Act, as amended (40 U.S.C. 3141-3148). When required by Federal program legislation, all prime construction contracts in excess of \$2,000 awarded by non-Federal entities must include a provision for compliance with the Davis-Bacon Act (40 U.S.C. 3141-3144, and 3146-3148) as supplemented by Department of Labor regulations (29 CFR Part 5, "Labor Standards Provisions Applicable to Contracts Covering Federally Financed and Assisted Construction"). In accordance with the statute, contractors must be required to pay wages to laborers and mechanics at a rate not less than the prevailing wages specified in a wage determination made by the Secretary of Labor. In addition, contractors must be required to pay wages not less than once a week. The non-Federal entity must place a copy of the current prevailing wage determination issued by the Department of Labor in each solicitation. The decision to award a contract or subcontract must be conditioned upon the acceptance of the wage determination. The non-Federal entity must report all suspected or reported violations to the Federal awarding agency. The contracts must also include a provision for compliance with the Copeland "Anti-Kickback" Act (40 U.S.C. 3145), as supplemented by Department of Labor regulations (29 CFR Part 3, "Contractors and Subcontractors on Public Building or Public Work Financed in Whole or in Part by Loans or Grants from the United States"). The Act provides that each contractor or subrecipient must be prohibited from inducing, by any means, any person employed in the construction, completion, or repair of public work, to give up any part of the compensation to which he or she is otherwise entitled. The non-Federal entity must report all suspected or reported violations to the Federal awarding agency.

Pursuant to Federal Rule (D) above, when a Participating Agency expends federal funds during the term of an award for all contracts and subgrants for construction or repair, offeror will be in compliance with all applicable Davis-Bacon Act provisions.

Does offeror agree? YES AW Initials of Authorized Representative of offeror

(E) Contract Work Hours and Safety Standards Act (40 U.S.C. 3701-3708). Where applicable, all contracts awarded by the non-Federal entity in excess of \$100,000 that involve the employment of mechanics or laborers must include a provision for compliance with 40 U.S.C. 3702 and 3704, as supplemented by Department of Labor regulations (29 CFR Part 5). Under 40 U.S.C. 3702 of the Act, each contractor must be required to compute the wages of every mechanic and laborer on the basis of a standard work week of 40 hours. Work in excess of the standard work week is permissible provided that the worker is compensated at a rate of not less than one and a half times the basic rate of pay for all hours worked in excess of 40 hours in the work week. The requirements of 40 U.S.C. 3704 are applicable to construction work and provide that no laborer or mechanic must be required to work in surroundings or under working conditions which are unsanitary, hazardous or dangerous. These requirements do not apply to the purchases of supplies or materials or articles ordinarily available on the open market, or contracts for transportation or transmission of intelligence.

Pursuant to Federal Rule (E) above, when a Participating Agency expends federal funds, offeror certifies that offeror will be in compliance with all applicable provisions of the Contract Work Hours and Safety Standards Act during the term of an award for all contracts by Participating Agency resulting from this procurement process.

Does offeror agree? YES AW Initials of Authorized Representative of offeror

(F) Rights to Inventions Made Under a Contract or Agreement. If the Federal award meets the definition of "funding agreement" under 37 CFR §401.2 (a) and the recipient or subrecipient wishes to enter into a contract with a small business firm or nonprofit organization regarding the substitution of parties, assignment or performance of experimental, developmental, or research work under that "funding agreement," the recipient or subrecipient must comply with the requirements of 37 CFR Part 401, "Rights to Inventions Made by Nonprofit Organizations and Small Business Firms Under Government Grants, Contracts and Cooperative Agreements," and any implementing regulations issued by the awarding agency.

Pursuant to Federal Rule (F) above, when federal funds are expended by Participating Agency, the offeror certifies that during the term of an award for all contracts by Participating Agency resulting from this procurement process, the offeror agrees to comply with all applicable requirements as referenced in Federal Rule (F) above.

Does offeror agree? YES AW Initials of Authorized Representative of offeror

(G) Clean Air Act (42 U.S.C. 7401-7671q.) and the Federal Water Pollution Control Act (33 U.S.C. 1251-1387), as amended— Contracts and subgrants of amounts in excess of \$150,000 must contain a provision that requires the non-Federal award to agree to comply with all applicable standards, orders or regulations issued pursuant to the Clean Air Act (42 U.S.C. 7401-7671q) and the Federal Water Pollution Control Act as amended (33 U.S.C. 1251-1387). Violations must be reported to the Federal awarding agency and the Regional Office of the Environmental Protection Agency (EPA)

Pursuant to Federal Rule (G) above, when federal funds are expended by Participating Agency, the offeror certifies that during the term of an award for all contracts by Participating Agency member resulting from this procurement process, the offeror agrees to comply with all applicable requirements as referenced in Federal Rule (G) above.

Does offeror agree? AW Initials of Authorized Representative of offeror

(H) Debarment and Suspension (Executive Orders 12549 and 12689)—A contract award (see 2 CFR 180.220) must not be made to parties listed on the government wide exclusions in the System for Award Management (SAM), in accordance with the Executive Office of the President Office of Management and Budget (OMB) guidelines at 2 CFR 180 that implement Executive Orders 12549 (3 CFR part 1986 Comp., p. 189) and 12689 (3 CFR part 1989 Comp., p. 235), "Debarment and Suspension." SAM Exclusions contains the names of parties debarred, suspended, or otherwise excluded by agencies, as well as parties declared ineligible under statutory or regulatory authority other than Executive Order 12549.

Pursuant to Federal Rule (H) above, when federal funds are expended by Participating Agency, the offeror certifies that during the term of an award for all contracts by Participating Agency resulting from this procurement process, the offeror certifies that neither it nor its principals is presently debarred, suspended, proposed for debarment, declared ineligible, or voluntarily excluded from participation by any federal department or agency. If at any time during the term of an award the offeror or its principals becomes debarred, suspended, proposed for debarment, declared ineligible, or voluntarily excluded from participation by any federal department or agency, the offeror will notify the Participating Agency.

Does offeror agree? AW Initials of Authorized Representative of offeror

(I) Byrd Anti-Lobbying Amendment (31 U.S.C. 1352)—Contractors that apply or bid for an award exceeding \$100,000 must file the required certification. Each tier certifies to the tier above that it will not and has not used Federal appropriated funds to pay any person or organization for influencing or attempting to influence an officer or employee of any agency, a member of Congress, officer or employee of Congress, or an employee of a member of Congress in connection with obtaining any Federal contract, grant or any other award covered by 31 U.S.C. 1352. Each tier must also disclose any lobbying with non-Federal funds that takes place in connection with obtaining any Federal award. Such disclosures are forwarded from tier to tier up to the non-Federal award.

Pursuant to Federal Rule (I) above, when federal funds are expended by Participating Agency, the offeror certifies that during the term and after the awarded term of an award for all contracts by Participating Agency resulting from this procurement process, the offeror certifies that it is in compliance with all applicable provisions of the Byrd Anti-Lobbying Amendment (31 U.S.C. 1352). The undersigned further certifies that:

- (1) No Federal appropriated funds have been paid or will be paid for on behalf of the undersigned, to any person for influencing or attempting to influence an officer or employee of any agency, a Member of Congress, an officer or employee of congress, or an employee of a Member of Congress in connection with the awarding of a Federal contract, the making of a Federal grant, the making of a Federal loan, the entering into a cooperative agreement, and the extension, continuation, renewal, amendment, or modification of a Federal contract, grant, loan, or cooperative agreement.
- (2) If any funds other than Federal appropriated funds have been paid or will be paid to any person for influencing or attempting to influence an officer or employee of any agency, a Member of Congress, an officer or employee of congress, or an employee of a Member of Congress in connection with this Federal grant or cooperative agreement, the undersigned shall complete and submit Standard Form-LLL, "Disclosure Form to Report Lobbying", in accordance with its instructions.
- (3) The undersigned shall require that the language of this certification be included in the award documents for all covered sub-awards exceeding \$100,000 in Federal funds at all appropriate tiers and that all subrecipients shall certify and disclose accordingly.

Does offeror agree? AW Initials of Authorized Representative of offeror

RECORD RETENTION REQUIREMENTS FOR CONTRACTS INVOLVING FEDERAL FUNDS

When federal funds are expended by Participating Agency for any contract resulting from this procurement process, offeror certifies that it will comply with the record retention requirements detailed in 2 CFR § 200.333. The offeror further certifies that offeror will retain all records as required by 2 CFR § 200.333 for a period of three years after grantees or subgrantees submit final expenditure reports or quarterly or annual financial reports, as applicable, and all other pending matters are closed.

Does offeror agree? AW Initials of Authorized Representative of offeror

CERTIFICATION OF COMPLIANCE WITH THE ENERGY POLICY AND CONSERVATION ACT

When Participating Agency expends federal funds for any contract resulting from this procurement process, offeror certifies that it will comply with the mandatory standards and policies relating to energy efficiency which are contained in the state energy conservation plan issued in compliance with the Energy Policy and Conservation Act (42 U.S.C. 6321 et seq.; 49 C.F.R. Part 18).

Does offeror agree? YES AW Initials of Authorized Representative of offeror

CERTIFICATION OF COMPLIANCE WITH BUY AMERICA PROVISIONS

To the extent purchases are made with Federal Highway Administration, Federal Railroad Administration, or Federal Transit Administration funds, offeror certifies that its products comply with all applicable provisions of the Buy America Act and agrees to provide such certification or applicable waiver with respect to specific products to any Participating Agency upon request. Purchases made in accordance with the Buy America Act must still follow the applicable procurement rules calling for free and open competition.

Does offeror agree? YES AW Initials of Authorized Representative of offeror

CERTIFICATION OF ACCESS TO RECORDS - 2 C.F.R. § 200.336

Offeror agrees that the Inspector General of the Agency or any of their duly authorized representatives shall have access to any documents, papers, or other records of offeror that are pertinent to offeror's discharge of its obligations under the Contract for the purpose of making audits, examinations, excerpts, and transcriptions. The right also includes timely and reasonable access to offeror's personnel for the purpose of interview and discussion relating to such documents.

Does offeror agree? YES AW Initials of Authorized Representative of offeror

CERTIFICATION OF APPLICABILITY TO SUBCONTRACTORS

Offeror agrees that all contracts it awards pursuant to the Contract shall be bound by the foregoing terms and conditions.

Does offeror agree? YES AW Initials of Authorized Representative of offeror

Offeror agrees to comply with all federal, state, and local laws, rules, regulations and ordinances, as applicable. It is further acknowledged that offeror certifies compliance with all provisions, laws, acts, regulations, etc. as specifically noted above.

Offeror's Name: School Health Corporation

Address, City, State, and Zip Code: 5600 Apollo Drive, Rolling Meadows, IL 60008

Phone Number: 866-323-5465 Fax Number: 800-235-1305

Printed Name and Title of Authorized Representative: Andrew Wlezen / Contract Sales Supervisor

Email Address: bids@schoolhealth.com

Signature of Authorized Representative: Andrew Wlezen Date: 7/13/2020

EXHIBIT G
NEW JERSEY BUSINESS COMPLIANCE

NEW JERSEY BUSINESS COMPLIANCE

Suppliers intending to do business in the State of New Jersey must comply with policies and procedures required under New Jersey statutes. All offerors submitting proposals must complete the following forms specific to the State of New Jersey. Completed forms should be submitted with the offeror's response to the RFP. Failure to complete the New Jersey packet will impact OMNIA Partners' ability to promote the Master Agreement in the State of New Jersey.

DOC #1	Ownership Disclosure Form
DOC #2	Non-Collusion Affidavit
DOC #3	Affirmative Action Affidavit
DOC #4	Political Contribution Disclosure Form
DOC #5	Stockholder Disclosure Certification
DOC #6	Certification of Non-Involvement in Prohibited Activities in Iran
DOC #7	New Jersey Business Registration Certificate

New Jersey suppliers are required to comply with the following New Jersey statutes when applicable:

- all anti-discrimination laws, including those contained in N.J.S.A. 10:2-1 through N.J.S.A. 10:2-14, N.J.S.A. 10:5-1, and N.J.S.A. 10:5-31 through 10:5-38;
- Prevailing Wage Act, N.J.S.A. 34:11-56.26, for all contracts within the contemplation of the Act;
- Public Works Contractor Registration Act, N.J.S.A. 34:11-56.26; and
- Bid and Performance Security, as required by the applicable municipal or state statutes.

**OWNERSHIP DISCLOSURE FORM
(N.J.S. 52:25-24.2)**

Pursuant to the requirements of P.L. 1999, Chapter 440 effective April 17, 2000 (Local Public Contracts Law), the offeror shall complete the form attached to these specifications listing the persons owning 10 percent (10%) or more of the firm presenting the proposal.

Company Name: School Health Corporation

Street: 5600 Apollo Drive

City, State, Zip Code: Rolling Meadows, IL 60008

Complete as appropriate:

I _____, certify that I am the sole owner of _____, that there are no partners and the business is not incorporated, and the provisions of N.J.S. 52:25-24.2 do not apply.

OR:

I _____, a partner in _____, do hereby certify that the following is a list of all individual partners who own a 10% or greater interest therein. I further certify that if one (1) or more of the partners is itself a corporation or partnership, there is also set forth the names and addresses of the stockholders holding 10% or more of that corporation's stock or the individual partners owning 10% or greater interest in that partnership.

OR:

I Andrew Wlezen, an authorized representative of School Health Corporation, a corporation, do hereby certify that the following is a list of the names and addresses of all stockholders in the corporation who own 10% or more of its stock of any class. I further certify that if one (1) or more of such stockholders is itself a corporation or partnership, that there is also set forth the names and addresses of the stockholders holding 10% or more of the corporation's stock or the individual partners owning a 10% or greater interest in that partnership.

(Note: If there are no partners or stockholders owning 10% or more interest, indicate none.)

Name	Address	Interest
See following pages		

I further certify that the statements and information contained herein, are complete and correct to the best of my knowledge and belief.

7/13/2020 Andrew Wlezen
Date

/ Contract Sales Supervisor
Authorized Signature and Title



Stockholders

School Health Corporation is registered in the state of Illinois.

Nancy Cormack	16.8%
Susan Rogers	23.4%
Scott Cormack	41.6%
Robert Rogers	18.2%



Stockholder Addresses:

Susan and Robert Rogers
1470 Pheasant Trail
Inverness, IL 60067

Scott Cormack
41 Marbridge Ct.
N. Barrington, IL 60010

Nancy Cormack
256 Dover Circle
Inverness, IL 60067

NON-COLLUSION AFFIDAVIT

Company Name: School Health Corporation

Street: 5600 Apollo Drive

City, State, Zip Code: Rolling Meadows, IL 60008

State of IL

County of Cook

I, Andrew Wlezen of the Rolling Meadows
Name City

in the County of Cook, State of Illinois
of full age, being duly sworn according to law on my oath depose and say that:

I am the Contract Sales Supervisor of the firm of School Health Corporation
Title Company Name

the Offeror making the Proposal for the goods, services or public work specified under the attached proposal, and that I executed the said proposal with full authority to do so; that said Offeror has not directly or indirectly entered into any agreement, participated in any collusion, or otherwise taken any action in restraint of free, competitive bidding in connection with the above proposal, and that all statements contained in said proposal and in this affidavit are true and correct, and made with full knowledge that relies upon the truth of the statements contained in said proposal and in the statements contained in this affidavit in awarding the contract for the said goods, services or public work.

I further warrant that no person or selling agency has been employed or retained to solicit or secure such contract upon an agreement or understanding for a commission, percentage, brokerage or contingent fee, except bona fide employees or bona fide established commercial or selling agencies maintained by

School Health Corporation
Company Name

Andrew Wlezen / Contract Sales Supervisor
Authorized Signature & Title

Subscribed and sworn before me

this 13 day of July, 2020

Karen Acevedo
Notary Public of Illinois

My commission expires Sept. 13, 2020

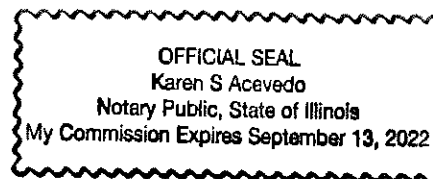

SEAL

DOC #3

**AFFIRMATIVE ACTION AFFIDAVIT
(P.L. 1975, C.127)**

Company Name: School Health Corporation

Street: 5600 Apollo Drive

City, State, Zip Code: Rolling Meadows, IL 60008

Proposal Certification:

Indicate below company's compliance with New Jersey Affirmative Action regulations. Company's proposal will be accepted even if company is not in compliance at this time. No contract and/or purchase order may be issued, however, until all Affirmative Action requirements are met.

Required Affirmative Action Evidence:

Procurement, Professional & Service Contracts (Exhibit A)

Vendors must submit with proposal:

1. A photo copy of their Federal Letter of Affirmative Action Plan Approval

OR
2. A photo copy of their Certificate of Employee Information Report

OR
3. A complete Affirmative Action Employee Information Report (AA302) _____

Public Work – Over \$50,000 Total Project Cost:

A. No approved Federal or New Jersey Affirmative Action Plan. We will complete Report Form AA201-A upon receipt from the

B. Approved Federal or New Jersey Plan – certificate enclosed

I further certify that the statements and information contained herein, are complete and correct to the best of my knowledge and belief.

7/13/2020
Date

Andrew Weger / Contract Sales Supervisor
Authorized Signature and Title

Certification 5531

CERTIFICATE OF EMPLOYEE INFORMATION REPORT

This is to certify that the contractor listed below has submitted an Employee Information Report pursuant to N.J.A.C. 17:27-1.1 et. seq. and the State Treasurer has approved said report. This approval will remain in effect for the period of 15 SEP 2019 to 15 SEP 2022

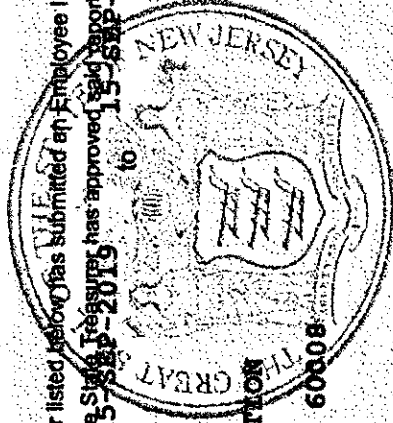

SCHOOL HEALTH CORPORATION
5600 APOLLO DRIVE
ROLLING MEADOWS IL 60008



Elizabeth Maher Muoio

ELIZABETH MAHER MUOIO
State Treasurer

P.L. 1995, c. 127 (N.J.A.C. 17:27)
MANDATORY AFFIRMATIVE ACTION LANGUAGE

PROCUREMENT, PROFESSIONAL AND SERVICE
CONTRACTS

During the performance of this contract, the contractor agrees as follows:

The contractor or subcontractor, where applicable, will not discriminate against any employee or applicant for employment because of age, race, creed, color, national origin, ancestry, marital status, sex, affectional or sexual orientation. The contractor will take affirmative action to ensure that such applicants are recruited and employed, and that employees are treated during employment, without regard to their age, race, creed, color, national origin, ancestry, marital status, sex, affectional or sexual orientation. Such action shall include, but not be limited to the following: employment, upgrading, demotion, or transfer; recruitment or recruitment advertising; layoff or termination; rates of pay or other forms of compensation; and selection for training, including apprenticeship. The contractor agrees to post in conspicuous places, available to employees and applicants for employment, notices to be provided by the Public Agency Compliance Officer setting forth provisions of this non-discrimination clause.

The contractor or subcontractor, where applicable will, in all solicitations or advertisement for employees placed by or on behalf of the contractor, state that all qualified applicants will receive consideration for employment without regard to age, race, creed, color, national origin, ancestry, marital status, sex, affectional or sexual orientation.

The contractor or subcontractor, where applicable, will send to each labor union or representative of workers with which it has a collective bargaining agreement or other contract or understanding, a notice, to be provided by the agency contracting officer advising the labor union or workers' representative of the contractor's commitments under this act and shall post copies of the notice in conspicuous places available to employees and applicants for employment.

The contractor or subcontractor, where applicable, agrees to comply with any regulations promulgated by the Treasurer pursuant to P.L. 1975, c. 127, as amended and supplemented from time to time and the Americans with Disabilities Act.

The contractor or subcontractor agrees to attempt in good faith to employ minority and female workers trade consistent with the applicable county employment goal prescribed by N.J.A.C. 17:27-5.2 promulgated by the Treasurer pursuant to P.L. 1975, C.127, as amended and supplemented from time to time or in accordance with a binding determination of the applicable county employment goals determined by the Affirmative Action Office pursuant to N.J.A.C. 17:27-5.2 promulgated by the Treasurer pursuant to P.L. 1975, C.127, as amended and supplemented from time to time.

The contractor or subcontractor agrees to inform in writing appropriate recruitment agencies in the area, including employment agencies, placement bureaus, colleges, universities, labor unions, that it does not discriminate on the basis of age, creed, color, national origin, ancestry, marital status, sex, affectional or sexual orientation, and that it will discontinue the use of any recruitment agency which engages in direct or indirect discriminatory practices.

The contractor or subcontractor agrees to revise any of its testing procedures, if necessary, to assure that all personnel testing conforms with the principles of job-related testing, as established by the statutes and court decisions of the state of New Jersey and as established by applicable Federal law and applicable Federal court decisions.

The contractor or subcontractor agrees to review all procedures relating to transfer, upgrading, downgrading and lay-off to ensure that all such actions are taken without regard to age, creed, color, national origin, ancestry, marital status, sex, affectional or sexual orientation, and conform with the applicable employment goals, consistent with the statutes and court decisions of the State of New Jersey, and applicable Federal law and applicable Federal court decisions.

The contractor and its subcontractors shall furnish such reports or other documents to the Affirmative Action Office as may be requested by the office from time to time in order to carry out the purposes of these regulations, and public agencies shall furnish such information as may be requested by the Affirmative Action Office for conducting a compliance investigation pursuant to Subchapter 10 of the Administrative Code (NJAC 17:27).

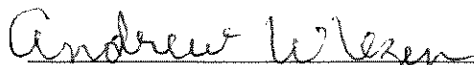

Signature of Procurement Agent

C. 271 POLITICAL CONTRIBUTION DISCLOSURE FORM

Public Agency Instructions

This page provides guidance to public agencies entering into contracts with business entities that are required to file Political Contribution Disclosure forms with the agency. **It is not intended to be provided to contractors.** What follows are instructions on the use of form local units can provide to contractors that are required to disclose political contributions pursuant to N.J.S.A. 19:44A-20.26 (P.L. 2005, c. 271, s.2). Additional information on the process is available in Local Finance Notice 2006-1 (http://www.nj.gov/dca/divisions/dlgs/resources/lfns_2006.html). Please refer back to these instructions for the appropriate links, as the Local Finance Notices include links that are no longer operational.

1. The disclosure is required for all contracts in excess of \$17,500 that are **not awarded** pursuant to a “fair and open” process (N.J.S.A. 19:44A-20.7).
2. Due to the potential length of some contractor submissions, the public agency should consider allowing data to be submitted in electronic form (i.e., spreadsheet, pdf file, etc.). Submissions must be kept with the contract documents or in an appropriate computer file and be available for public access. **The form is worded to accept this alternate submission.** The text should be amended if electronic submission will not be allowed.
3. The submission must be **received from the contractor and** on file at least 10 days prior to award of the contract. Resolutions of award should reflect that the disclosure has been received and is on file.
4. The contractor must disclose contributions made to candidate and party committees covering a wide range of public agencies, including all public agencies that have elected officials in the county of the public agency, state legislative positions, and various state entities. The Division of Local Government Services recommends that contractors be provided a list of the affected agencies. This will assist contractors in determining the campaign and political committees of the officials and candidates affected by the disclosure.
 - a. The Division has prepared model disclosure forms for each county. They can be downloaded from the “County PCD Forms” link on the Pay-to-Play web site at <http://www.nj.gov/dca/divisions/dlgs/programs/lpcl.html#12>. They will be updated from time-to-time as necessary.
 - b. A public agency using these forms **should edit them to properly reflect the correct legislative district(s)**. As the forms are county-based, **they list all legislative districts** in each county. **Districts that do not represent the public agency should be removed from the lists.**
 - c. Some contractors may find it easier to provide a single list that covers all contributions, regardless of the county. These submissions are appropriate and should be accepted.
 - d. The form may be used “as-is”, subject to edits as described herein.
 - e. The “Contractor Instructions” sheet is intended to be provided with the form. It is recommended that the Instructions and the form be printed on the same piece of paper. The form notes that the Instructions are printed on the back of the form; where that is not the case, the text should be edited accordingly.
 - f. The form is a Word document and can be edited to meet local needs, and posted for download on web sites, used as an e-mail attachment, or provided as a printed document.
5. It is recommended that the contractor also complete a “Stockholder Disclosure Certification.” This will assist the local unit in its obligation to ensure that contractor did not make any prohibited contributions to the committees listed on the Business Entity Disclosure Certification in the 12 months prior to the contract (See Local Finance Notice 2006-7 for additional information on this obligation at http://www.nj.gov/dca/divisions/dlgs/resources/lfns_2006.html). A sample Certification form is part of this package and the instruction to complete it is included in the Contractor Instructions. NOTE: This section is not applicable to Boards of Education.

C. 271 POLITICAL CONTRIBUTION DISCLOSURE FORM

Contractor Instructions

Business entities (contractors) receiving contracts from a public agency that are NOT awarded pursuant to a "fair and open" process (defined at N.J.S.A. 19:44A-20.7) are subject to the provisions of P.L. 2005, c. 271, s.2 (N.J.S.A. 19:44A-20.26). This law provides that 10 days prior to the award of such a contract, the contractor shall disclose contributions to:

- any State, county, or municipal committee of a political party
- any legislative leadership committee*
- any continuing political committee (a.k.a., political action committee)
- any candidate committee of a candidate for, or holder of, an elective office:
 - of the public entity awarding the contract
 - of that county in which that public entity is located
 - of another public entity within that county
 - or of a legislative district in which that public entity is located or, when the public entity is a county, of any legislative district which includes all or part of the county

The disclosure must list reportable contributions to any of the committees that exceed \$300 per election cycle that were made during the 12 months prior to award of the contract. See N.J.S.A. 19:44A-8 and 19:44A-16 for more details on reportable contributions.

N.J.S.A. 19:44A-20.26 itemizes the parties from whom contributions must be disclosed when a business entity is not a natural person. This includes the following:

- individuals with an "interest" ownership or control of more than 10% of the profits or assets of a business entity or 10% of the stock in the case of a business entity that is a corporation for profit
- all principals, partners, officers, or directors of the business entity or their spouses
- any subsidiaries directly or indirectly controlled by the business entity
- IRS Code Section 527 New Jersey based organizations, directly or indirectly controlled by the business entity and filing as continuing political committees, (PACs).

When the business entity is a natural person, "a contribution by that person's spouse or child, residing therewith, shall be deemed to be a contribution by the business entity." [N.J.S.A. 19:44A-20.26(b)] The contributor must be listed on the disclosure.

Any business entity that fails to comply with the disclosure provisions shall be subject to a fine imposed by ELEC in an amount to be determined by the Commission which may be based upon the amount that the business entity failed to report.

The enclosed list of agencies is provided to assist the contractor in identifying those public agencies whose elected official and/or candidate campaign committees are affected by the disclosure requirement. It is the contractor's responsibility to identify the specific committees to which contributions may have been made and need to be disclosed. The disclosed information may exceed the minimum requirement.

The enclosed form, a content-consistent facsimile, or an electronic data file containing the required details (along with a signed cover sheet) may be used as the contractor's submission and is disclosable to the public under the Open Public Records Act.

The contractor must also complete the attached Stockholder Disclosure Certification. This will assist the agency in meeting its obligations under the law. **NOTE: This section does not apply to Board of Education contracts.**

* N.J.S.A. 19:44A-3(s): "The term "legislative leadership committee" means a committee established, authorized to be established, or designated by the President of the Senate, the Minority Leader of the Senate, the Speaker of the General Assembly or the Minority Leader of the General Assembly pursuant to section 16 of P.L.1993, c.65 (C.19:44A-10.1) for the purpose of receiving contributions and making expenditures."

Not Applicable

DOC #4, continued

List of Agencies with Elected Officials Required for Political Contribution Disclosure
N.J.S.A. 19:44A-20.26

County Name:

State: Governor, and Legislative Leadership Committees

Legislative District #s:

State Senator and two members of the General Assembly per district.

County:

Freeholders

{County Executive}

County Clerk

Surrogate

Sheriff

Municipalities (Mayor and members of governing body, regardless of title):

**USERS SHOULD CREATE THEIR OWN FORM, OR DOWNLOAD
FROM THE PAY TO PLAY SECTION OF THE DLGS WEBSITE A
COUNTY-BASED, CUSTOMIZABLE FORM.**

STOCKHOLDER DISCLOSURE CERTIFICATION

Name of Business:

I certify that the list below contains the names and home addresses of all stockholders holding 10% or more of the issued and outstanding stock of the undersigned.

OR

I certify that no one stockholder owns 10% or more of the issued and outstanding stock of the undersigned.

Check the box that represents the type of business organization:

Partnership Corporation Sole Proprietorship

Limited Partnership Limited Liability Corporation Limited Liability Partnership

Subchapter S Corporation

Sign and notarize the form below, and, if necessary, complete the stockholder list below.

Stockholders:

Name: See following pages	Name:
Home Address:	Home Address:
Name:	Name:
Home Address:	Home Address:
Name:	Name:
Home Address:	Home Address:

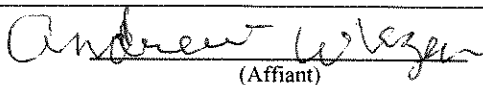
Subscribed and sworn before me this <u>13</u> day of <u>June</u> , <u>2020</u>	 (Affiant)
(Notary Public) <u>Karen Acevedo</u>	<u>Andrew Wlezen / Contract Sales Supervisor</u> (Print name & title of affiant)
My Commission expires: <u>Sept. 13, 2022</u>	(Corporate Seal)

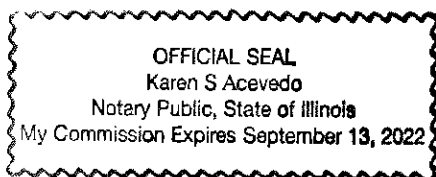



Stockholders

School Health Corporation is registered in the state of Illinois.

Nancy Cormack	16.8%
Susan Rogers	23.4%
Scott Cormack	41.6%
Robert Rogers	18.2%



Stockholder Addresses:

Susan and Robert Rogers
1470 Pheasant Trail
Inverness, IL 60067

Scott Cormack
41 Marbridge Ct.
N. Barrington, IL 60010

Nancy Cormack
256 Dover Circle
Inverness, IL 60067

Certification of Non-Involvement in Prohibited Activities in Iran

Pursuant to N.J.S.A. 52:32-58, Offerors must certify that neither the Offeror, nor any of its parents, subsidiaries, and/or affiliates (as defined in N.J.S.A. 52:32 – 56(e) (3)), is listed on the Department of the Treasury’s List of Persons or Entities Engaging in Prohibited Investment Activities in Iran and that neither is involved in any of the investment activities set forth in N.J.S.A. 52:32 – 56(f).

Offerors wishing to do business in New Jersey through this contract must fill out the Certification of Non-Involvement in Prohibited Activities in Iran here:

http://www.state.nj.us/humanservices/dfd/info/standard/fdc/disclosure_investmentact.pdf.

Offerors should submit the above form completed with their proposal.

STATE OF NEW JERSEY -- DIVISION OF PURCHASE AND PROPERTY
DISCLOSURE OF INVESTMENT ACTIVITIES IN IRAN

Quote Number: 20-11

Bidder/Offeror: School Health Corporation

PART 1: CERTIFICATION

BIDDERS MUST COMPLETE PART 1 BY CHECKING EITHER BOX.

FAILURE TO CHECK ONE OF THE BOXES WILL RENDER THE PROPOSAL NON-RESPONSIVE.

Pursuant to Public Law 2012, c. 25, any person or entity that submits a bid or proposal or otherwise proposes to enter into or renew a contract must complete the certification below to attest, under penalty of perjury, that neither the person or entity, nor any of its parents, subsidiaries, or affiliates, is identified on the Department of Treasury's Chapter 25 list as a person or entity engaging in investment activities in Iran. The Chapter 25 list is found on the Division's website at <http://www.state.nj.us/treasury/purchase/pdf/Chapter25List.pdf>. Bidders must review this list prior to completing the below certification. Failure to complete the certification will render a bidder's proposal non-responsive. If the Director finds a person or entity to be in violation of law, s/he shall take action as may be appropriate and provided by law, rule or contract, including but not limited to, imposing sanctions, seeking compliance, recovering damages, declaring the party in default and seeking debarment or suspension of the party

PLEASE CHECK THE APPROPRIATE BOX:

I certify, pursuant to Public Law 2012, c. 25, that neither the bidder listed above nor any of the bidder's parents, subsidiaries, or affiliates is listed on the N.J. Department of the Treasury's list of entities determined to be engaged in prohibited activities in Iran pursuant to P.L. 2012, c. 25 ("Chapter 25 List"). I further certify that I am the person listed above, or I am an officer or representative of the entity listed above and am authorized to make this certification on its behalf. I will skip Part 2 and sign and complete the Certification below.

OR

I am unable to certify as above because the bidder and/or one or more of its parents, subsidiaries, or affiliates is listed on the Department's Chapter 25 list. I will provide a detailed, accurate and precise description of the activities in Part 2 below and sign and complete the Certification below. Failure to provide such will result in the proposal being rendered as non-responsive and appropriate penalties, fines and/or sanctions will be assessed as provided by law.

PART 2: PLEASE PROVIDE FURTHER INFORMATION RELATED TO INVESTMENT ACTIVITIES IN IRAN

You must provide a detailed, accurate and precise description of the activities of the bidding person/entity, or one of its parents, subsidiaries or affiliates, engaging in the investment activities in Iran outlined above by completing the boxes below.

EACH BOX WILL PROMPT YOU TO PROVIDE INFORMATION RELATIVE TO THE ABOVE QUESTIONS. PLEASE PROVIDE THOROUGH ANSWERS TO EACH QUESTION. IF YOU NEED TO MAKE ADDITIONAL ENTRIES, CLICK THE "ADD AN ADDITIONAL ACTIVITIES ENTRY" BUTTON.

Name _____	Relationship to Bidder/Offeror _____
Description of Activities _____	
Duration of Engagement _____	Anticipated Cessation Date _____
Bidder/Offeror Contact Name _____	Contact Phone Number _____

ADD AN ADDITIONAL ACTIVITIES ENTRY

Certification: I, being duly sworn upon my oath, hereby represent and state that the foregoing information and any attachments thereto to the best of my knowledge are true and complete. I attest that I am authorized to execute this certification on behalf of the above-referenced person or entity. I acknowledge that the State of New Jersey is relying on the information contained herein and thereby acknowledge that I am under a continuing obligation from the date of this certification through the completion of any contracts with the State to notify the State in writing of any changes to the answers of information contained herein. I acknowledge that I am aware that it is a criminal offense to make a false statement or misrepresentation in this certification, and if I do so, I recognize that I am subject to criminal prosecution under the law and that it will also constitute a material breach of my agreement(s) with the State of New Jersey and that the State at its option may declare any contract(s) resulting from this certification void and unenforceable.

Full Name (Print): Andrew Wlezen

Signature: *Andrew Wlezen*

Title: Contract Sales Supervisor

Date: 7/13/2020

DOC #7

**NEW JERSEY BUSINESS REGISTRATION CERTIFICATE
(N.J.S.A. 52:32-44)**

Offerors wishing to do business in New Jersey must submit their State Division of Revenue issued Business Registration Certificate with their proposal here. Failure to do so will disqualify the Offeror from offering products or services in New Jersey through any resulting contract.

<http://www.state.nj.us/treasury/revenue/forms/njreg.pdf>



STATE OF NEW JERSEY BUSINESS REGISTRATION CERTIFICATE

Taxpayer Name: SCHOOL HEALTH SUPPLY CO.
Trade Name:
Address: 5600 APOLLO DRIVE
ROLLING MEADOWS, IL 60008
Certificate Number: 0092174
Effective Date: May 16, 1990
Date of Issuance: November 18, 2019

For Office Use Only:
20191118142833886

Tab 4



Qualification and Experience

- i. We are a national, full-service provider of health supplies and services to health professionals in educational settings from pre-school to college. We collaborate with customers and are an advocate for the health and wellness of those entrusted in their care. At School Health, we maintain the integrity in each of our interactions by always keeping our mission and value statements in mind.

Since our founding in 1957, School Health has been dedicated to helping school-based health professionals keep their students healthy. We all know that healthier students are better students. From our initial focus on school nurses, we have expanded to serve athletic trainers, early childhood specialists and special needs educators.

Our comprehensive offering includes health supplies, sports medicine equipment, early childhood products, physical education, recreation and athletic products and special needs aids. School Health goes beyond merely supplying products, providing product support, training, advisory services and exceptional customer care.

Our Corporate office is located at 5600 Apollo Drive, Rolling Meadows, IL 60008

- ii. School Health Corporation has been doing business with school nurses for over 60 years. We have built a great reputation in the industry with the exceptional service we provide. Here are some thoughts from our customers:
 - a. "You had the items we needed, service was fast and ordering was easy. This made my life easier and I appreciate that."
 - b. "Working with my rep is fantastic. She does a great job and is fun to work with. Give her a raise!"
 - c. "I have used School Health at different locations since I entered school nursing 17 years ago. I have found the service, products and timeliness of delivery to be unmatched by other companies I have had to order from. I often recommend your company to other business units and other school nurses."
- iii. School Health offers the latest and most innovative products offered in this market. We have several product managers dedicated to their respective markets, working with our vendors to offer the newest products available at a competitive price. Our product managers work closing with our sales team by supporting product demo's and offering additional support when meeting with our customers.



- iv. School Health Corporation has several individuals supporting this contract with several years of market experience.
 - a. Sales – Gina Streepy (National Accounts Manager, 25 years of market experience)
 - b. Sales – Christine Carlton (Texas Sales Representative, 9 years of market experience)
 - c. Sales – Rachel Hodges (Texas Sales Representative, 2 years of market experience)
 - d. Sales Support – Gail Kinateder (National Accounts Support, 18 years of market experience)
 - e. Sales Reporting – Andrew Wlezen (Contract Sales Supervisor, 23 years of market experience)
 - f. Executive Support – John Rooney (Vice President of Sales, 11 years of market experience)
- v. School Health Corporation has worked with several government agencies and will provide references.
- vi. School Health Corporation does not have any past litigation, bankruptcy, reorganization, state investigations of entity or current officers and directors.
- vii. Here are our references:
 - a. Sourcewell / National Joint Powers Alliance
 - Contact: Lindsey Meech / Contract Administrator Specialist
 - Phone: 218-895-4123
 - Email: lindsey.meech@sourcewell-mn.gov
 - City/State: Staples, MN
 - Years of Service: 11 years
 - Description: Provide Health & Safety, Medical, Surgical, and First Aid Related Equipment, Supplies, Accessories, and Services
 - Annual Volume: \$4 million
 - b. Educational Data Services
 - Contact: John O'Connor
 - Phone: 973-340-8800 ext 17
 - Email: JohnO@ed-data.com
 - City/State: Saddlebrook, NJ
 - Years of Service: 13 years
 - Description: Provide Health & Trainer Supplies
 - Annual Volume: \$3.2 million
 - c. Commonwealth of Pennsylvania (COSTARS)
 - Contact: Kathy Lewis / Commodity Specialist
 - Phone: 717-346-4056
 - Email: kalewis@pa.gov
 - City/State: Harrisburg, PA
 - Years of Service: 12 years
 - Description: Provide Medical Supplies and Emergency Response Supplies
 - Annual Volume: \$575,316

5600 Apollo Drive, Rolling Meadows, Illinois 60008
Phone 866-323-5465 | Fax 800-235-1305



- d. Capital Region Education Council (CREC)
Contact: Cara Hart / Cooperative Purchasing Manager
Phone: 860-524-4021
Email: chart@crec.org
City/State: Hartford, CT
Years of Service: 13+ years
Description: Provide Medical Supplies
Annual Volume: \$48,974
- e. Massachusetts Higher Education Consortium (MHEC)
Contact: Joan Miller / Sr. Contract Manager
Phone: 413-992-2504
Email: joanmiller@mhec.net
City/State: Amherst, MA
Years of Service: 8 years
Description: Provide Medical/Dental/Pharmaceutical Equipment, Supplies and Service
Annual Volume: \$525,903
- f. Texas Association of School Boards, Inc (Buyboard)
Contact: Director of Purchasing
Phone: 512-467-0222
Email: bids@buyboard.com
City/State: Austin, TX
Years of Service: 13+ years
Description: Provide First Aid, Emergency Medical, and Athletic Trainer Supplies and Equipment
Annual Volume: \$444,999
- g. AEA Purchasing
Contact: Joni Puffett / Purchasing
Phone: 563-922-2299
Email: joni@aeapurchasing.org
City/State: Cedar Falls, IA
Years of Service: 15+ years
Description: Provide Health Supplies
Annual Volume: \$292,490
- h. Ohio River Valley Unified Purchasing Coop
Contact: Rich Pingilley / Purchasing
Phone: 513-728-7908
Email: rich@mail.hccanet.org
City/State: Cincinnati, OH
Years of Service: 9 years
Description: Provide School Nursing Supplies
Annual Volume: \$17,534
- i. Tolleson Elementary School District
Contact: Sallie Rader / Procurement Specialist

5600 Apollo Drive, Rolling Meadows, Illinois 60008
Phone 866-323-5465 | Fax 800-235-1305



Phone: 623-533-3927

Email: srader@tesd.k12.az.us

City/State: Tolleson, AZ

Years of Service: 15+ years

Description: Provide Medical Supplies and Equipment

Annual Volume: \$48,856

j. Region VIII Educational Service Center

Contact: Purchasing Department

Phone: 866-839-8477

Email: bids@tips-usa.com

City/State: Pittsburg, TX

Years of Service: 8 years

Description: Provide Medical Equipment and Supplies

Annual Volume: \$12,230

- viii. Online/Technology Capabilities – School Health has a fully functional website which provides useful product information and pictures, allows ordering and purchasing products through the site. There is a supply list function that allows customers to create and maintain lists of items they'd like to purchase or items purchased frequently. There is also a virtual catalog, online order form and the ability to send quote requests and product requests. School Health utilizes powerful technology to service our ecommerce customers. First, we are proud to say our website is the best in the industry. Shoppers can find operating manuals, MSDS, FAQ's, videos and more to help them make their buying decisions without ever having to leave the page. OMNIA Partnerns customers will have the most up to date information at their fingertips 24/7. We have also installed advanced search and navigation features so that locating a product on the site is quicker and easier than ever. Additionally, customers have the ability to create their own personal account on the site and can save multiple shipping addresses to their address book, making it easy to checkout and order from us again and again. Other features include Live Chat, the ability to create and save supply lists for easy supply ordering, the ability to create large orders easily using the order by item number feature and the ability to ship to multiple addresses from one shopping cart. For our contract customers, we have the ability to offer contract pricing online with the option of a dedicated landing page and virtual store where customers can shop their specific contract products and see their discounts as they shop.



REFERENCES

- **Sourcewell / National Joint Powers Alliance (NJPA)**
 - Contract # 061417-SHC
 - Annual Sales
 - 2018 - \$4,276,030
 - 2017 - \$3,228,388
 - 2016 - \$2,866,408

- **Educational Data Services**
 - Contract # 9300 & 9345
 - Annual Sales
 - 2018 - \$3,284,212
 - 2017 - \$3,188,853
 - 2016 - \$2,895,153

- **Commonwealth of Pennsylvania (COSTARS)**
 - Contract # 019-019
 - Annual Sales
 - 2018 - \$575,316
 - 2017 - \$301,062
 - 2016 - \$172,160

- **Capital Region Education Council (CREC)**
 - SH Contract #3560983
 - Annual Sales
 - 2018 - \$48,974
 - 2017 - \$54,116
 - 2016 - \$42,631



- **Massachusetts Higher Education Consortium (MHEC)**
 - Contract # MC12-D32
 - Annual Sales
 - 2018 - \$525,903
 - 2017 - \$328,717
 - 2016 - \$284,059

- **Texas Association of School Boards, Inc. (TASB/Buy Board)**
 - Contract #530-17
 - Annual Sales
 - 2018 - \$444,999
 - 2017 - \$258,013
 - 2016 - \$214,200

- **AEA Purchasing**
 - Contract #HEALTHRFP2018
 - Annual Sales
 - 2018 - \$292,490
 - 2017 - \$287,564
 - 2016 - \$267,748

- **Ohio River Valley Unified Purchasing Coop**
 - Contract # NU-2012
 - Annual Sales
 - 2018 - \$17,534
 - 2017 - \$26,898
 - 2016 - \$23,324

Tab 5



Value Add

School Health Corporation has sales reps located throughout the country, an Inside Sales team and Customer Care Center predicated on providing exceptional service. Please reference the OMNIA Partners Contract # 20-11 or School Health# 3793158 when inquiring on pricing or looking to place an order. This will ensure members receive the proper pricing. School Health accepts all forms of purchase orders: faxed, emailed, paper, website and over the phone. We offer Net 30 terms on all OMNIA Partners purchases and also accepts payment via American Express, MasterCard, Discovery and VISA. School Health has product managers that cover Athletic Supplies and PE Supplies to make sure we are offering to newest and most innovative products on the market. We run several marketing campaigns and publish different catalogs throughout the year.

In partnering with OMNIA Partners, the School Health customers benefit from this National contract on many levels. First, the contract awards our customers the ability to purchase over 20,000 quality products, equipment and supplies on a National level pricing scale. A School Health customer benefits by having a dedicated and fully trained Sales and Customer Care team assigned to each territory. We assist with product questions, training and services without additional cost to the end user. Our staff regularly researches state mandates to anticipate questions, source products or equipment to meet state requirements prior to the specified date of a law taking effect.

The School Health team can be a huge asset to our customers by taking excellent service to the next level, saving their administration time and money, and relieving them of the expensive bid process. School Health Corporation carries and supports the widest spectrum of products and services in the market for healthcare customers including but not limited to: athletic, physical education, bleeding control kits, diagnostic equipment, emergency response/first aid kits, healthcare furniture, infection control, medical equipment & supplies, nursing supplies, patient supplies, respiratory, simulators/manikins and speech therapy solutions.

School Health provides support/training for all health/medical equipment sold. School Health's highly trained certified technicians located in our Calibration, Parts and Repair department are able to provide customers with vision and hearing product information as needed, as well as product calibrations and repairs. School Health's highly trained sales staff will arrange for product in-services upon customer request. Many products,

5600 Apollo Drive, Rolling Meadows, Illinois 60008
Phone 866-323-5465 | Fax 800-235-1305



such as AED's, can be sold with program management services through the OMNIA Partners contract which make training available to product end users. Our customer training is described in the School Health Mission Statement:

School Health's mission is to offer medical products and supplies that are innovative and exceptionally well made, which are supported with competitive pricing, education on how to best use these products and reliable services. By providing this unique service, we help our customers improve the health and well being of those entrusted in their care.

The following is a sample list of product trainings/services that are a "value add" to customers:

- Vision screening
- Hearing Screening
- Software Tracking (concussions, vision, student management)
- Included calibrations
- WA Partners in Care
- SECA – Partner Program
- AED site assessments, equipment training, program management

Other value added programs referenced are custom website creation and management, grant writing assistance, freight consolidation and more.

Tab 6

Appendix C
ADDITIONAL REQUIRED DOCUMENTS

- DOC #1 Acknowledgment and Acceptance of Region 4 ESC's Open Records Policy
- DOC #2 Antitrust Certification Statements (Tex. Government Code § 2155.005)
- DOC #3 Implementation of House Bill 1295 Certificate of Interested Parties (Form 1295)
- DOC #4 Texas Government Code 2270 Verification Form

ACKNOWLEDGMENT AND ACCEPTANCE
OF REGION 4 ESC's OPEN RECORDS POLICY

OPEN RECORDS POLICY

All proposals, information and documents submitted are subject to the Public Information Act requirements governed by the State of Texas once a Contract(s) is executed. If an Offeror believes its response, or parts of its response, may be exempted from disclosure, the Offeror must specify page-by-page and line-by-line the parts of the response, which it believes, are exempt and include detailed reasons to substantiate the exemption. Price is not confidential and will not be withheld. Any unmarked information will be considered public information and released, if requested under the Public Information Act.

The determination of whether information is confidential and not subject to disclosure is the duty of the Office of Attorney General (OAG). Region 4 ESC must provide the OAG sufficient information to render an opinion and therefore, vague and general claims to confidentiality by the Offeror are not acceptable. Region 4 ESC must comply with the opinions of the OAG. Region 4 ESC assumes no responsibility for asserting legal arguments on behalf of any Offeror. Offeror is advised to consult with their legal counsel concerning disclosure issues resulting from this procurement process and to take precautions to safeguard trade secrets and other proprietary information.

Signature below certifies complete acceptance of Region 4 ESC's Open Records Policy, except as noted below (additional pages may be attached, if necessary).

Check one of the following responses to the Acknowledgment and Acceptance of Region 4 ESC's Open Records Policy below:

- We acknowledge Region 4 ESC's Open Records Policy and declare that no information submitted with this proposal, or any part of our proposal, is exempt from disclosure under the Public Information Act.
- We declare the following information to be a trade secret or proprietary and exempt from disclosure under the Public Information Act.

(Note: Offeror must specify page-by-page and line-by-line the parts of the response, which it believes, are exempt. In addition, Offeror must include detailed reasons to substantiate the exemption(s). Price is not confidential and will not be withheld. All information believed to be a trade secret or proprietary must be listed. It is further understood that failure to identify such information, in strict accordance with the instructions, will result in that information being considered public information and released, if requested under the Public Information Act.)

7/13/2020
Date

Andrew Weizer Contract Sales Supervisor
Authorized Signature & Title

ANTITRUST CERTIFICATION STATEMENTS
(Tex. Government Code § 2155.005)
Attorney General Form

I affirm under penalty of perjury of the laws of the State of Texas that:

1. I am duly authorized to execute this Contract on my own behalf or on behalf of the company, corporation, firm, partnership or individual (Company) listed below;
2. In connection with this proposal, neither I nor any representative of the Company has violated any provision of the Texas Free Enterprise and Antitrust Act, Tex. Bus. & Comm. Code Chapter 15;
3. In connection with this proposal, neither I nor any representative of the Company has violated any federal antitrust law; and
4. Neither I nor any representative of the Company has directly or indirectly communicated any of the contents of this proposal to a competitor of the Company or any other company, corporation, firm, partnership or individual engaged in the same line of business as the Company.

Company

School Health Corporation

Contact

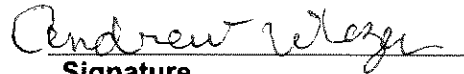

Signature

Andrew Wlezen

Printed Name

Contract Sales Supervisor

Position with Company

Address

5600 Apollo Drive

Rolling Meadows, IL 60008

**Official
Authorizing
Proposal**



Signature

Karen Acevedo

Printed Name

Contract Sales Specialist

Position with Company

Phone

866-323-5465

Fax

800-235-1305

Implementation of House Bill 1295

Certificate of Interested Parties (Form 1295):

In 2015, the Texas Legislature adopted House Bill 1295, which added section 2252.908 of the Government Code. The law states that a governmental entity or state agency may not enter into certain contracts with a business entity unless the business entity submits a disclosure of interested parties to the governmental entity or state agency at the time the business entity submits the signed contract to the governmental entity or state agency. The law applies only to a contract of a governmental entity or state agency that either (1) requires an action or vote by the governing body of the entity or agency before the contract may be signed or (2) has a value of at least \$1 million. The disclosure requirement applies to a contract entered into on or after January 1, 2016.

The Texas Ethics Commission was required to adopt rules necessary to implement that law, prescribe the disclosure of interested parties form, and post a copy of the form on the commission's website. The commission adopted the Certificate of Interested Parties form (Form 1295) on October 5, 2015. The commission also adopted new rules (Chapter 46) on November 30, 2015, to implement the law. The commission does not have any additional authority to enforce or interpret House Bill 1295.

Filing Process:

Starting on January 1, 2016, the commission made available on its website a new filing application that must be used to file Form 1295. A business entity must use the application to enter the required information on Form 1295 and print a copy of the completed form, which will include a certification of filing that will contain a unique certification number. An authorized agent of the business entity must sign the printed copy of the form. The completed Form 1295 with the certification of filing must be filed with the governmental body or state agency with which the business entity is entering into the contract.

The governmental entity or state agency must notify the commission, using the commission's filing application, of the receipt of the filed Form 1295 with the certification of filing not later than the 30th day after the date the contract binds all parties to the contract. This process is known as acknowledging the certificate. The commission will post the acknowledged Form 1295 to its website within seven business days after receiving notice from the governmental entity or state agency. The posted acknowledged form does not contain the declaration of signature information provided by the business.

A certificate will stay in the pending state until it is acknowledged by the governmental agency. Only acknowledged certificates are posted to the commission's website.

Electronic Filing Application:

https://www.ethics.state.tx.us/whatsnew/elf_info_form1295.htm

Frequently Asked Questions:

https://www.ethics.state.tx.us/resources/FAQs/FAQ_Form1295.php

Changes to Form 1295: <https://www.ethics.state.tx.us/data/filinginfo/1295Changes.pdf>

CERTIFICATE OF INTERESTED PARTIES

FORM 1295

1 of 1

Complete Nos. 1 - 4 and 6 if there are interested parties.
Complete Nos. 1, 2, 3, 5, and 6 if there are no interested parties.

OFFICE USE ONLY CERTIFICATION OF FILING

Certificate Number:
2020-643464

Date Filed:
07/13/2020

Date Acknowledged:

1 Name of business entity filing form, and the city, state and country of the business entity's place of business.

School Health Corporation
Rolling Meadows, IL United States

2 Name of governmental entity or state agency that is a party to the contract for which the form is being filed.

Region 4 Education Service Center

3 Provide the identification number used by the governmental entity or state agency to track or identify the contract, and provide a description of the services, goods, or other property to be provided under the contract.

20-11
Athletic, Physical Education Supplies and Team Uniforms

4	Name of Interested Party	City, State, Country (place of business)	Nature of interest (check applicable)	
			Controlling	Intermediary

5 Check only if there is NO interested Party.

6 UNSWORN DECLARATION

My name is Andrew Wlezen, and my date of birth is 7/3/1982.

My address is 5600 Apollo Drive, Rolling Meadows, IL, 60008, USA.
(street) (city) (state) (zip code) (country)

I declare under penalty of perjury that the foregoing is true and correct.

Executed in Cook County, State of IL, on the 13 day of July, 2020.
(month) (year)

Andrew Wlezen
Signature of authorized agent of contracting business entity
(Declarant)

Texas Government Code 2270 Verification Form

House Bill 89 (85R Legislative Session), which adds Chapter 2270 to the Texas Government Code, provides that a governmental entity may not enter into a contract with a company without verification that the contracting vendor does not and will not boycott Israel during the term of the contract.

Furthermore, Senate Bill 252 (85R Legislative Session), which amends Chapter 2252 of the Texas Government Code to add Subchapter F, prohibits contracting with a company engaged in business with Iran, Sudan or a foreign terrorist organization identified on a list prepared by the Texas Comptroller.

I, Andrew Wlezen, as an authorized representative of

School Health Corporation, a contractor engaged by

Insert Name of Company

Region 4 Education Service Center, 7145 West Tidwell Road, Houston, TX 77092, verify by this writing that the above-named company affirms that it (1) does not boycott Israel; and (2) will not boycott Israel during the term of this contract, or any contract with the above-named Texas governmental entity in the future.

Also, our company is not listed on and we do not do business with companies that are on the Texas Comptroller of Public Accounts list of Designated Foreign Terrorists Organizations found at <https://comptroller.texas.gov/purchasing/docs/foreign-terrorist.pdf>.

I further affirm that if our company's position on this issue is reversed and this affirmation is no longer valid, that the above-named Texas governmental entity will be notified in writing within one (1) business day and we understand that our company's failure to affirm and comply with the requirements of Texas Government Code 2270 et seq. shall be grounds for immediate contract termination without penalty to the above-named Texas governmental entity.

I swear and affirm that the above is true and correct.

Andrew Wlezen
Signature of Named Authorized Company Representative

7/13/2020
Date



7145 West Tidwell Road ~ Houston, Texas 77092
(713)-462-7708
www.esc4.net

NOTICE TO OFFEROR

ADDENDUM NO. 1

Solicitation Number 20-11

Request for Proposal ("RFP")
by Region 4 Education Service Center ("ESC")
for Athletic, Physical Education Supplies, and Team Uniforms

This Addendum No. 1 amends the Request for Proposals (RFP) for Athletic, Physical Education Supplies, and Team Uniforms and Services 20-11 ("Addendum"). To the extent of any discrepancy between the original RFP and this Addendum, this Addendum shall prevail.

Region 4 Education Service Center ("Region 4 ESC") requests proposals from qualified suppliers with the intent to enter into a Contract for Athletic, Physical Education Supplies, and Team Uniforms. Addendum No. 1 is hereby issued as follows:

CHANGES TO THE RFP TO UPDATE THE SUBMITTAL DEADLINE

1. Page 1, Line 11

Remove the submittal deadline and replace with the following:

SUBMITTAL DEADLINE: Tuesday, April 14, 2020, 10:00 AM CENTRAL TIME

2. Page 1, Paragraph 2

Remove the 2nd sentence from paragraph 2 and replace with the following:

Submissions must be received by the Region 4 ESC office at: 7145 West Tidwell Road, Houston, TX 77092 no later than 10:00 a.m. central time.

3. Page 4, Section II. **CALENDAR OF EVENTS (ALL DATES ARE TENTATIVE AND SUBJECT TO CHANGE)**, Line 6

Remove line 6 regarding the Proposal Due Date and replace with the following:
Proposal Due Date April 14, 2020

RECEIPT OF ADDENDUM NO. 1 ACKNOWLEDGEMENT

Offeror shall acknowledge this addendum by signing below and include in their proposal response.

Company Name School Health Corporation

Contact Person Andrew Wlezen

Signature Andrew Wlezen

Date 7/13/2020

Crystal Wallace
Region 4 Education Service Center
Business Operations Specialist



7145 West Tidwell Road ~ Houston, Texas 77092
(713)-462-7708
www.esc4.net

NOTICE TO OFFEROR

ADDENDUM NO. 2

Solicitation Number 20-11

Request for Proposal ("RFP")
by Region 4 Education Service Center ("ESC")
for Athletic, Physical Education Supplies, and Team Uniforms

This Addendum No. 2 amends the Request for Proposals (RFP) for Athletic, Physical Education Supplies, and Team Uniforms and Services 20-11 ("Addendum"). To the extent of any discrepancy between the original RFP and this Addendum, this Addendum shall prevail.

Region 4 Education Service Center ("Region 4 ESC") requests proposals from qualified suppliers with the intent to enter into a Contract for Athletic, Physical Education Supplies, and Team Uniforms. Addendum No. 2 is hereby issued as follows:

CHANGES TO THE RFP TO UPDATE THE SUBMITTAL DEADLINE

1. Page 1, Line 11
Remove the submittal deadline and replace with the following:

SUBMITTAL DEADLINE: Tuesday, May 5, 2020, 10:00 AM CENTRAL TIME
2. Page 4, **Section II. CALENDAR OF EVENTS (ALL DATES ARE TENTATIVE AND SUBJECT TO CHANGE)**, Line 6

Remove line 6 regarding the Proposal Due Date and replace with the following:
Proposal Due Date May 5, 2020

RECEIPT OF ADDENDUM NO. 2 ACKNOWLEDGEMENT

Offeror shall acknowledge this addendum by signing below and include in their proposal response.

Company Name School Health Corporation

Contact Person Andrew Wlezen

Signature Andrew Wlezen

Date 7/13/2020

Crystal Wallace
Region 4 Education Service Center
Business Operations Specialist



7145 West Tidwell Road ~ Houston, Texas 77092
(713)-462-7708
www.esc4.net

NOTICE TO OFFEROR

ADDENDUM NO. 3

Solicitation Number 20-11

Request for Proposal ("RFP")
by Region 4 Education Service Center ("ESC")
for Athletic, Physical Education Supplies, and Team Uniforms

This Addendum No. 3 amends the Request for Proposals (RFP) for Athletic, Physical Education Supplies, and Team Uniforms and Services 20-11 ("Addendum"). To the extent of any discrepancy between the original RFP and this Addendum, this Addendum shall prevail.

Region 4 Education Service Center ("Region 4 ESC") requests proposals from qualified suppliers with the intent to enter into a Contract for Athletic, Physical Education Supplies, and Team Uniforms. Addendum No. 3 is hereby issued as follows:

CHANGES TO THE RFP

1. Page 6, Section 5

To waive the bond copy requirement, remove Section 5. Proposal Format and replace with the following:

Proposal Format: Proposals must contain two (2) electronic copies on flash drives with signed copies of the solicitation. Offeror must also submit two (2) electronic proposals free of propriety information to be posted, if awarded a Contract. Offerors may also provide two (2) bound and signed original copies of the solicitation, however bound copies are not required.

Only sealed responses will be accepted. Faxed or electronically transmitted responses will not be accepted. Sealed responses may be submitted on any or all items, unless stated otherwise.

If bound copies are provided, responses should be provided in a three-ring binder or report cover using 8.5 x 11 paper clearly identified with the name of the Offeror's company and the solicitation name and number on both the outside front cover and vertical spine.

Tabs should be used to separate the proposal into sections. The following items identified must be included behind the tabs listed below. Each section should contain both the section of the RFP referenced and the Offeror's response to that section. Offerors failing to organize in the manner listed may be considered non-responsive and may not be evaluated.

2. Required Documents with Notary

Any document requiring appearance before a notary shall be waived until a later date or upon Region 4 ESC request.

RECEIPT OF ADDENDUM NO. 3 ACKNOWLEDGEMENT

Offeror shall acknowledge this addendum by signing below and include in their proposal response.

Company Name School Health Corporation

Contact Person Andrew Wlezen

Signature Andrew Wlezen

Date 7/13/2020

Crystal Wallace
Region 4 Education Service Center
Business Operations Specialist



7145 West Tidwell Road ~ Houston, Texas 77092
(713)-462-7708
www.esc4.net

NOTICE TO OFFEROR

ADDENDUM NO. 4

Solicitation Number 20-11

Request for Proposal ("RFP")
by Region 4 Education Service Center ("ESC")
for Athletic, Physical Education Supplies, and Team Uniforms

This Addendum No. 4 amends the Request for Proposals (RFP) for Athletic, Physical Education Supplies, and Team Uniforms and Services 20-11 ("Addendum"). To the extent of any discrepancy between the original RFP and this Addendum, this Addendum shall prevail.

Region 4 Education Service Center ("Region 4 ESC") requests proposals from qualified suppliers with the intent to enter into a Contract for Athletic, Physical Education Supplies, and Team Uniforms. Addendum No. 4 is hereby issued as follows:

CLARIFICATIONS

1. The Submittal Deadline is extended via this Addendum.
2. Approval from Region 4 ESC is moved via this Addendum.

CHANGES TO THE RFP

1. Page 1, Line 12:

Remove the submittal deadline and replace with the following:

SUBMITTAL DEADLINE: Thursday, June 18, 2020, 10:00 AM CENTRAL TIME

All other items on this page shall remain.

2. Page 4, Section II. CALENDER OF EVENTS (ALL DATES ARE TENTATIVE AND SUBJECT TO CHANGE):

Remove the calendar of events and replace with the following:

<u>Event</u>	<u>Date</u>
<i>Issue RFP</i>	<i>February 13, 2020</i>
<i>Pre-proposal Conference</i>	<i>March 10, 2020</i>
<i>Deadline for receipt of questions via email</i>	<i>March 12, 2020</i>
<i>Issue Addenda (if required)</i>	<i>March 19, 2020</i>
<i>Proposal Due Date</i>	<i>June 18, 2020</i>
<i>Approval from Region 4 ESC</i>	<i>August 25, 2020</i>
<i>Contract Effective Date</i>	<i>October 1, 2020</i>

All other items on this page shall remain.

RECEIPT OF ADDENDUM NO. 4 ACKNOWLEDGEMENT

Offeror shall acknowledge this addendum by signing below and include in their proposal response.

Company Name School Health Corporation

Contact Person Andrew Wiezen

Signature Andrew Wiezen

Date 7/13/2020

Crystal Wallace
Region 4 Education Service Center
Business Operations Specialist



7145 West Tidwell Road ~ Houston, Texas 77092
(713)-462-7708
www.esc4.net

NOTICE TO OFFEROR

ADDENDUM NO. 5

Solicitation Number 20-11

Request for Proposal ("RFP")
by Region 4 Education Service Center ("ESC")
for Athletic, Physical Education Supplies, and Team Uniforms

This Addendum No. 5 amends the Request for Proposals (RFP) for Athletic, Physical Education Supplies, and Team Uniforms and Services 20-11 ("Addendum"). To the extent of any discrepancy between the original RFP and this Addendum, this Addendum shall prevail.

Region 4 Education Service Center ("Region 4 ESC") requests proposals from qualified suppliers with the intent to enter into a Contract for Athletic, Physical Education Supplies, and Team Uniforms. Addendum No. 5 is hereby issued as follows:

CLARIFICATIONS

1. The Submittal Deadline is extended via this Addendum.

CHANGES TO THE RFP

1. Page 1, Line 12:

Remove the submittal deadline and replace with the following:

SUBMITTAL DEADLINE: Tuesday, July 14, 2020, 10:00 AM CENTRAL TIME

All other items on this page shall remain.

2. Page 4, Section II. CALENDER OF EVENTS (ALL DATES ARE TENTATIVE AND SUBJECT TO CHANGE):

Remove the calendar of events and replace with the following:

<u>Event</u>	<u>Date</u>
<i>Issue RFP</i>	<i>February 13, 2020</i>
<i>Pre-proposal Conference</i>	<i>March 10, 2020</i>
<i>Deadline for receipt of questions via email</i>	<i>March 12, 2020</i>
<i>Issue Addenda (if required)</i>	<i>March 19, 2020</i>
<i>Proposal Due Date</i>	<i>July 14, 2020</i>
<i>Approval from Region 4 ESC</i>	<i>August 25, 2020</i>
<i>Contract Effective Date</i>	<i>October 1, 2020</i>

All other items on this page shall remain.

RECEIPT OF ADDENDUM NO. 5 ACKNOWLEDGEMENT

Offeror shall acknowledge this addendum by signing below and include in their proposal response.

Company Name School Health Corporation

Contact Person Andrew Wiezen

Signature Andrew Wiezen

Date 7/13/2020

Crystal Wallace
Region 4 Education Service Center
Business Operations Specialist